

**Single/Dual/Triple/Quad-Channel Current-Ratio-Optimized LED Driver  
with Analog and PWM Dimming  
U-DFN-4030-14**

### Description

The AL1791/1792/1793/1794 (or collectively AL179x), a single/multi-channel LED driver with analog and PWM dimming control, is targeted for Tunable White/Color Smart Lighting application. It serves as the LED driving element along with AC-DC Power Conversion Block and Intelligent wireless MCU as an emerging smart-connected lighting system configuration. The key merits attribute to cost-effectiveness, dimming performance, low standby power, ease of system implementation, and great scalability. AL1791, AL1792, AL1793, and AL1794 are 1-channel, 2-channel, 3-channel, and 4-channel LED drivers, respectively.

The IC is available in U-DFN-4030-14 package.

### Pin Assignments

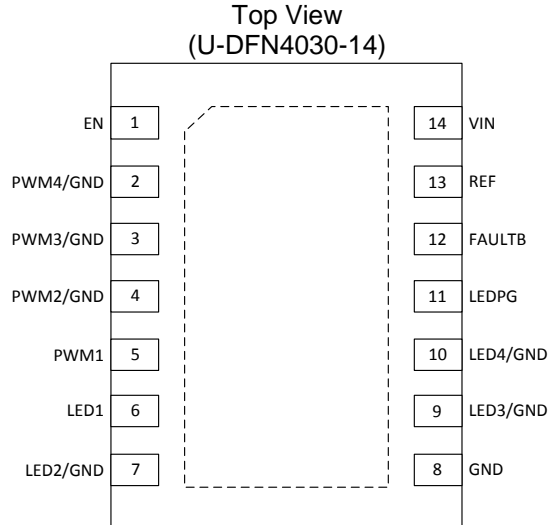

### Features

- Input Voltage Range: 6.5V to 30V
- 1/2/3/4-channel LED drivers: independent Analog or PWM dimming control for each channel
- Reference Current: Adjustable by an external reference resistor
- Ratio-optimized currents for 4 independent LED channels (AL1794 only): Suitable for Tunable White and Tunable Color
- Low Standby Power: With EN pin
- E-flicker free High Frequency PWM dimming with Deep Dimming Capability: Support 10KHz down to 1.0%, 4KHz down to 0.4%, or 1KHz down to 0.1%
- Internal Protections: Under Voltage Lockout (UVLO), LED string open/short protection
- Over-temperature protection (OTP): Thermal shutdown and auto thermal recovery
- Fault Reporting: UVLO, OTP, Open, and Short LED Power Good Reporting
- Low system BOM cost
- Ambient Temperature Range -40°C to +125°C
- U-DFN4030-14: Available in "Green" Molding Compound (No Br, Sb)
- **Totally Lead-Free & Fully RoHS Compliant (Notes 1 & 2)**
- **Halogen and Antimony Free. "Green" Device (Note 3)**

### Applications

- 1-Channel Dimmable Smart Connected Light (SCL) Bulbs
- 2-Channel Tunable White SCL Bulbs
- 3-Channel Tunable White or Color SCL Bulbs
- 4-Channel Tunable White+Color SCL Bulbs
- Smart Connected LED Tubes, Panel Lights, Troffers, and Ceiling Lights

Notes:

1. No purposely added lead. Fully EU Directive 2002/95/EC (RoHS) & 2011/65/EU (RoHS 2) compliant.
2. See [http://www.diodes.com/quality/lead\\_free.html](http://www.diodes.com/quality/lead_free.html) for more information about Diodes Incorporated's definitions of Halogen- and Antimony-free, "Green", and Lead-free.
3. Halogen- and Antimony-free "Green" products are defined as those which contain <900ppm bromine, <900ppm chlorine (<1500ppm total Br + Cl) and <1000ppm antimony compounds.

**Typical Applications Circuit**



**Figure 1. 1-Channel Dimmable White**



**Figure 2. 2-Channel Tunable White**

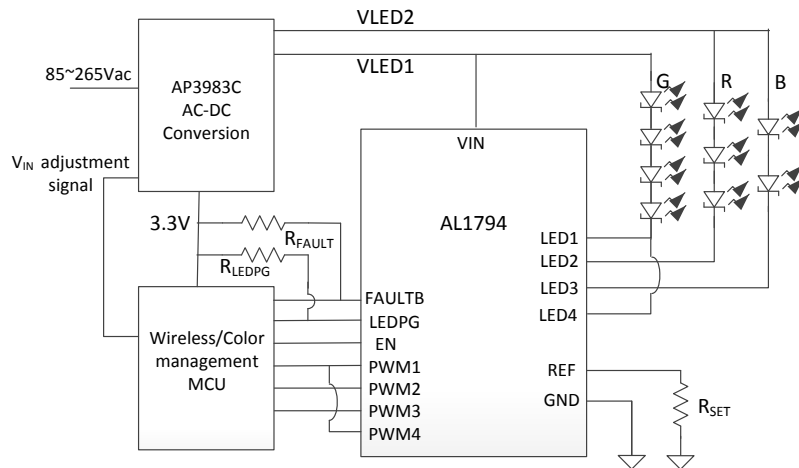

**Figure 3. 3-Channel Tunable Color**

**Typical Applications Circuit** (continued)



**Figure 4. 4-Channel White+Tunable RGB**

**Detailed Description**

The AL1791, AL1792, AL1793, and AL1794 are single-channel, dual-channel, triple-channel, and four-channel, respectively, ratio-optimized constant-current regulators optimized for Tunable White and Tunable Color, Smart Lighting applications. The maximum current channel can drive up to 500mA with a total driving current up to 1.0A, 1.5A, and 1.5A for AL1792, AL1793, and AL1794 respectively. The maximum current for AL1791 is 1A (refer to Table 1 below). The minimum channel current is recommended as in Table 2 in order to meet channel current accuracy and short protection specifications. Each channel can still be individually controlled by either digital PWM dimming down to 0.10%@1KHz, 0.4%@4KHz, or 1.0%@10KHz or analog dimming. The integrated low-side current sinks allow LED common-anode connections for cost effectiveness or different anode voltages for efficiency optimization.

AL179x	Channel 1	Channel 2	Channel 3	Channel 4	Total IC Current
AL1791	1.0A	X	X	X	1.0A
AL1792	0.5A	0.5A	X	X	1.0A
AL1793	0.5A	0.5A	0.5A	X	1.5A
AL1794	0.5A	0.5A	0.375A	0.125A	1.5A

**Table 1 Recommended Maximum Channel Current and Total IC Current for AL179x**

AL179x	Channel 1	Channel 2	Channel 3	Channel 4	Total IC Current
AL1791	0.2A	X	X	X	0.2A
AL1792	0.1A	0.1A	X	X	0.2A
AL1793	0.1A	0.1A	0.1A	X	0.3A
AL1794	0.1A	0.1A	0.075A	0.025A	0.3A

**Table 2 Recommended Minimum Channel Current and Total IC Current for AL179x**

The device detects fault conditions and reports its status on FAULTB pin. It features LED open detection, LED short detection, Over-Temperature Protection (OTP), and Undervoltage Lockout (UVLO). The AL179x provides supreme current matching between channels and devices. Along with bus-mode fault reporting, multiple devices can be employed together to increase current driving capability or channel count versatility.

**Enable and Soft-Start**

The AL179x is enabled when the voltage at EN pin is greater than approximately 2.5V, and disabled when it is lower than 0.4V. When EN pin is asserted high and VIN pin is ramped up beyond minimum operation voltage, a soft-start will be performed with a slew-rate-controlled current ramp over 100µs at LEDx output pins to minimize current overshoot through LED strings for optimal system reliability.

## Detailed Description (continued)

### LED Current Setting and Current Ratio

The AL1792 and AL1793 are designed to have an equal-sized channel current ratio for all channels, while the AL1794 is equipped with ratio-optimized current sinks. The current ratio is predetermined and facilitated for Tunable Color or Tunable White applications. The absolute current levels can be adjusted externally with  $R_{SET}$  resistor. The LED current is expressed as below:

For AL1791:

$$I_{LED1} = 4000 * \frac{V_{REF}}{R_{SET}}$$

For AL1792:

$$I_{LED1} = 2000 * \frac{V_{REF}}{R_{SET}}$$

$$I_{LED2} = 2000 * \frac{V_{REF}}{R_{SET}}$$

For AL1793:

$$I_{LED1} = 2000 * \frac{V_{REF}}{R_{SET}}$$

$$I_{LED2} = 2000 * \frac{V_{REF}}{R_{SET}}$$

$$I_{LED3} = 2000 * \frac{V_{REF}}{R_{SET}}$$

For AL1794:

$$I_{LED1} = 2000 * \frac{V_{REF}}{R_{SET}}$$

$$I_{LED2} = 2000 * \frac{V_{REF}}{R_{SET}}$$

$$I_{LED3} = 1500 * \frac{V_{REF}}{R_{SET}}$$

$$I_{LED4} = 500 * \frac{V_{REF}}{R_{SET}}$$

*where  $V_{REF} = 1.5V$  nominally for all devices*

For example, when an  $R_{SET}$  of 12K $\Omega$  is used, Channel 1, 2, 3, and 4 of AL1794 provide a current of 250mA, 250mA, 187.5mA, and 62.5mA respectively. For the same  $R_{SET}$  setting, each channel of AL1792 and AL1793 provides same current amount of 250mA. AL1791 provides 500mA for the same  $R_{SET}$  setting.

The maximum LED current for Channel 1 can be adjusted up to 500mA via  $R_{SET}$  resistor. The other channels will provide current levels with the same predetermined ratio. Any two or more channels can be tied together to drive one LED string with aggregated current. So when current needed for any channel is greater than the maximum value the device can provide, two or more channels or devices can be paralleled together to provide the drive current needed.

### PWM Dimming Control

When any one of the PWMx pins is connected to PWM signals with frequency ranging from 500Hz and above during startup, the device is determined in PWM dimming mode. In this mode, a high level of PWM signal will turn on the current sink to flow through the LED and low level will turn it off. Consequently, the LED current and LED brightness of each corresponding channel can be adjusted.

The pulse width of the PWM signal is recommended to be greater than 2.5 $\mu$ s to support down to 0.25%@1KHz deep dimming capability still with good linearity. Further deeper dimming through higher frequency PWM signals is possible, which maintains reasonable linearity - 0.1%@1KHz, 0.4%@4KHz, or 1.0%@10KHz. PWM signals can be driven static low or high to turn off or on the corresponding channels constantly.

---

## Detailed Description (cont.)

---

### Analog Dimming Control

With the same PWMx pins, analog dimming can be facilitated to control the brightness of each LED channel. When no PWM signal with frequency ranging from 500Hz and above during startup is present at PWMx pins, the device is determined in analog dimming mode. In this mode, the signals at PWMx pins are interpreted as analog dimming signals. The meaningful dimming voltage should range from 0.4V to 1.5V. When the voltage is 0.4V or below, the current-sink turns off the LED string. When the voltage is 1.5V or above, it turns the current level on to 100%. For any voltage between 0.4V to 1.5V, the current level is linearly prorated to its full scale.

### Undervoltage Lockout

The Undervoltage lockout function (UVLO) guarantees that the device is initially off during start-up. The UVLO functions only when the device is enabled. Even if the AL179x is enabled, the device is not turned ON until the power supply has reached 6.3V. Whenever the input voltage falls below approximately 6V, the device is turned off. The UVLO circuit has a hysteresis of 300mV. During UVLO, a FAULTB status will be reported.

### Over-Temperature Protection

Thermal protection prevents the IC from damage when the die temperature exceeds safe margins. The AL1791/1792/1793/1794 features Over-Temperature Protection (OTP). When the junction temperature reaches +160°C, the device will enter thermal shutdown mode in which all current sinks are shut down and no current flows to the LED strings. The normal current level can be automatically restored to its set current from OTP by triggering a Soft Start when the temperature lowers down below +100°C. Thermal Shut Mode will also be reported as a FAULTB.

### LED Open and Short Protection

AL179x detects the LED status by continuously monitoring the current and voltage status of the LED strings. When an abnormal condition occurs (LED Open or LED Short), FAULTB is asserted low. In the case of LED Short, all output channels will be turned off. In the case of LED Open, all non-affected channels remain in the normal operating condition.

### Fault Reporting

Fault reporting serves as a good communication channel between LED drivers and intelligent MCU unit. AL179x detects and reports the FAULTB status upon the occurrence of Thermal Shutdown in OTP, LED Short, LED Open, and UVLO. FAULTB pin is an open-drain output design. Multiple devices can share a single FAULTB signal by connecting all FAULTB pins together with an external pull-up resistor. Any FAULTB assertion from any device pulls the signal down and informs MCU of the faulty condition.

### LED Power Good Reporting

The Input Voltage to drive all attached Emitter Strings needs to maintain voltage level over required total  $V_F$  of emitter string plus a minimum voltage headroom (VLED\_REG). On the other hand, excessive voltage headroom provided needs to be absorbed by AL179x, which increases heat dissipation to complicate thermal management. Power Good reporting serves as a mechanism to detect the LED power supply condition and adjusts the supply voltage to LEDs through MCU in order to minimize unnecessary overdrive voltage to the regulator and optimize the efficiency. AL179x constantly detects and reports  $V_{LEDx}$  (voltage measured at Pin LEDx) output headroom condition by asserting LEDPG pin. If the  $V_{LEDx}$  in any channel is lower than or close to the dropout voltage required by the regulator (VLED\_REG) while the channel is enabled with PWMx and EN, LEDPG pin will be pulled down to ground. During PWMx low period, internal LEDPG will not report insufficient headroom for that channel. Internal LED Power Good logics are ANDed together before brought out to the pin. Any channel's insufficient headroom condition will trigger a logic Low at LEDPG pin. This signal can then be used by MCU to wisely adjust the LED power and thus the voltages to the LEDx pins to minimize power consumption on AL179x. LEDPG needs to be connected with an external pull-up resistor. Multiple AL179x devices can also share a single pull-up resistor to create a unified LEDPG signal.

## Pin Descriptions

Pin Name	Part Number	Descriptions
	U-DFN4030-14	
EN	1	Active-high to Enable, Internally Pulled Down
PWM4/GND	2	PWM Signal Input for channel 4, Internally Pulled Down for AL1794. GND for AL1791, AL1792, and AL1793.
PWM3/GND	3	PWM Signal Input for channel 3, Internally Pulled Down for AL1793 and AL1794. GND for AL1791 and AL1792.
PWM2/GND	4	PWM Signal Input for channel 2, Internally Pulled Down for AL1792, AL1793, and AL1794. GND for AL1791.
PWM1	5	PWM Signal Input for channel 1, Internally Pulled Down (Tied to GND when this channel is NOT used).
LED1	6	Channel 1 LED Cathode
LED2/GND	7	Channel 2 LED Cathode for AL1792, AL1793, and AL1794. GND for AL1791.
GND	8	Ground
LED3/GND	9	Channel 3 LED Cathode for AL1793 and AL1794. GND for AL1791 and AL1792.
LED4/GND	10	Channel 4 LED Cathode for AL1794. GND for AL1791, AL1792, and AL1793.
LEDPG	11	LED Power Good Indication. Asserted Low to report insufficient headroom. Needs an external pull-up resistor.
FAULTB	12	Fault Report. Asserted Low to report faulty conditions. Needs an external pull-up resistor.
REF	13	Reference Current Setting through External Resistor (R <sub>SET</sub> )
VIN	14	Voltage Input
Exposed PAD	Exposed PAD	Exposed pad. Internally connected to GND. It should be externally connected to GND and thermal mass for enhanced thermal impedance. It should not be used as electrical conduction path.

**Functional Block Diagram**



**Figure 5. Functional Block Diagram of AL1792/1793/1794 (Note 4)**

Note: 4. PWM2 and LED2 are not applicable to AL1791. PWM3 and LED3 are not applicable to AL1791 and AL1792. PWM4 and LED4 are not applicable to AL1791, AL1792, and AL1793.

**Absolute Maximum Ratings** (@T<sub>A</sub> = +25°C, unless otherwise specified.)

Symbol	Parameter		Ratings	Units
ESD	HBM	Human Body Model ESD Protection	4,000	V
	CDM	Charged Device Model ESD Protection	1,000	V
V <sub>IN</sub>	Input Voltage		30	V
V <sub>EN</sub> , V <sub>PWMx</sub>	Enable Voltage, PWM Voltage		7	V
T <sub>J(MAX)</sub>	Maximum Junction Temperature		160	°C
T <sub>ST</sub>	Storage Temperature Range		-65 to +150	°C

Caution: Stresses greater than the 'Absolute Maximum Ratings' specified above, may cause permanent damage to the device. These are stress ratings only; functional operation of the device at these or any other conditions exceeding those indicated in this specification is not implied. Device reliability may be affected by exposure to absolute maximum rating conditions for extended periods of time. Semiconductor devices are ESD sensitive and may be damaged by exposure to ESD events. Suitable ESD precautions should be taken when handling and transporting these devices

**Recommended Operating Conditions** (@T<sub>A</sub> = +25°C, unless otherwise specified.)

Symbol	Parameter	Min	Max	Unit
V <sub>IN</sub>	Input voltage at VIN	6.5	30	V
T <sub>A</sub>	Operating Ambient Temperature	-40	125	°C
V <sub>IH</sub>	High-Level Input Voltage on EN and PWMx	2.5	5.5	V
V <sub>IL</sub>	Low-Level Input Voltage on EN and PWMx	0	0.4	V

**Electrical Characteristics** (@T<sub>A</sub> = +25°C, V<sub>IN</sub> = +12V, unless otherwise specified.)

Symbol	Parameter	Test Conditions	Min	Typ	Max	Unit
V <sub>UVLO</sub>	UVLO Voltage	V <sub>IN</sub> Rising	—	6.3	—	V
V <sub>UVHYS</sub>	UVLO Hysteresis	V <sub>IN</sub> Falling	—	300	—	mV
I <sub>SHDN</sub>	Shutdown Supply Current	Disabled	—	10	—	μA
I <sub>Q</sub>	Quiescent Supply Current	Enabled, LEDx floating, PWMx are "L", R <sub>SET</sub> is 12KΩ	—	2	—	mA
V <sub>IL(EN)</sub>	EN Low Voltage	—	0	—	0.4	V
V <sub>IH(EN)</sub>	EN High Voltage	—	2.5	—	—	V
I <sub>(EN-PD)</sub>	EN Internal Pulldown	V <sub>EN</sub> =5V	0.35	—	3.5	μA
V <sub>IL(PWMx)</sub>	Digital PWM Low Voltage	—	—	—	0.3	V
V <sub>IH(PWMx)</sub>	Digital PWM High Voltage	—	2.5	—	—	V
F <sub>PWMx</sub>	Digital PWM Frequency	—	0.5	—	4	KHz
I <sub>(PWMx-PD)</sub>	PWM Internal Pulldown	V <sub>EN</sub> =5V	0.35	—	3.5	μA
T <sub>PWMx_MIN_ON</sub>	Minimum PWMx On Time	—	—	2.5	—	μS
V <sub>ADIM_MIN</sub>	Analog Dimming Min Voltage	—	—	0.4	—	V
V <sub>ADIM_MAX</sub>	Analog Dimming Max Voltage	—	—	1.5	—	V
V <sub>REF</sub>	Reference Voltage	—	1.47	1.5	1.53	V
I <sub>REF</sub>	Reference Current	R <sub>SET</sub> =12KΩ	—	0.125	—	mA
I <sub>LED1_NOM</sub>	Regulation Current for Channel 1	R <sub>SET</sub> =12KΩ	—	250	—	mA
I <sub>LED2_NOM</sub>	Regulation Current for Channel 2	R <sub>SET</sub> =12KΩ	—	250	—	mA
I <sub>LED3_NOM</sub>	Regulation Current for Channel 3 (not for AL1792)	R <sub>SET</sub> =12KΩ	—	187.5	—	mA
I <sub>LED4_NOM</sub>	Regulation Current for Channel 4 (not for AL1792/1793)	R <sub>SET</sub> =12KΩ	—	62.5	—	mA
V <sub>LED_REG</sub>	Minimum LED Regulation Voltage	I <sub>LED1</sub> =250mA	—	250	—	mV
I <sub>LED_LEAK</sub>	LEDx Leakage Current	V <sub>PWMx</sub> =0V, V <sub>LEDx</sub> =+12V	—	0.1	2	μA
I <sub>LED_ACCURACY</sub>	LED Current Accuracy	R <sub>SET</sub> =12KΩ	-4.0	—	4.0	%
V <sub>LEDSPH</sub>	LED Short Protection Threshold	—	—	6	—	V
T <sub>LEDSDHG</sub>	Short-detection Deglitch	Analog Dimming	—	2	—	mS
N <sub>LEDSDHG</sub>		PWM Dimming (count the number of continuous cycles when LED short is detected)	—	6	—	Cycles
T <sub>LEDDPDG</sub>	Open-detection Deglitch	Analog Dimming	—	2	—	mS
N <sub>LEDDPDG</sub>		PWM Dimming (count the number of continuous cycles when LED open is detected)	—	6	—	Cycles
T <sub>SS</sub>	Soft-start Time	V <sub>EN</sub> =5V, 90% of I <sub>LEDx_NOM</sub>	—	100	—	μS
T <sub>SHDN</sub>	Thermal Shutdown Threshold	R <sub>SET</sub> =12KΩ	—	160	—	°C
T <sub>REC</sub>	Thermal Recovery Threshold	R <sub>SET</sub> =12KΩ	—	100	—	°C
V <sub>FOL</sub>	FAULTB Output Low Voltage	I <sub>FAULTB</sub> =1mA	—	—	180	mV
I <sub>FOH</sub>	FAULTB Leakage Current	V <sub>FAULTB</sub> =6V	—	—	1	μA
θ <sub>JA</sub>	Thermal Resistance Junction-to-Ambient	U-DFN4030-14 (Note 5)	—	55	—	°C/W
θ <sub>JC</sub>	Thermal Resistance Junction-to-Case	U-DFN4030-14 (Note 5)	—	12	—	°C/W

Note: 5. Device mounted on 2" x 2" FR-4 substrate PCB, 2oz copper, with minimum recommended pad on top layer and thermal vias to bottom layer ground plane.



**Typical Performance Characteristics** ( $V_{IN}=12V$ ,  $R_{SET}=12K\Omega$ ,  $R_{FAULT}=10K\Omega$ ,  $T_A=+25^\circ C$ , unless otherwise specified.)

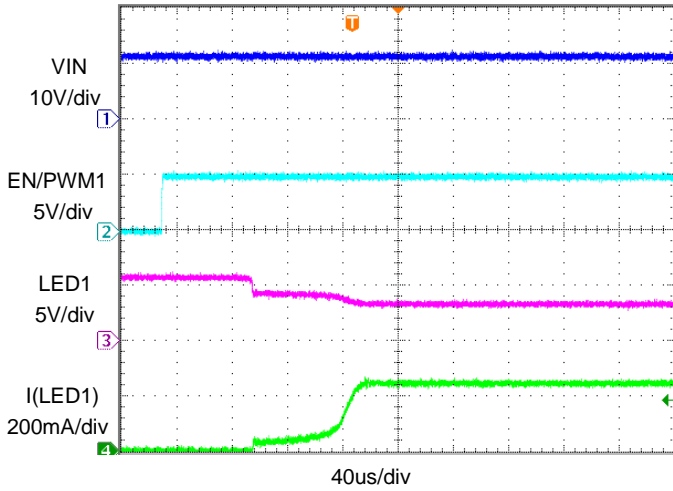

**Figure 6 System Startup**

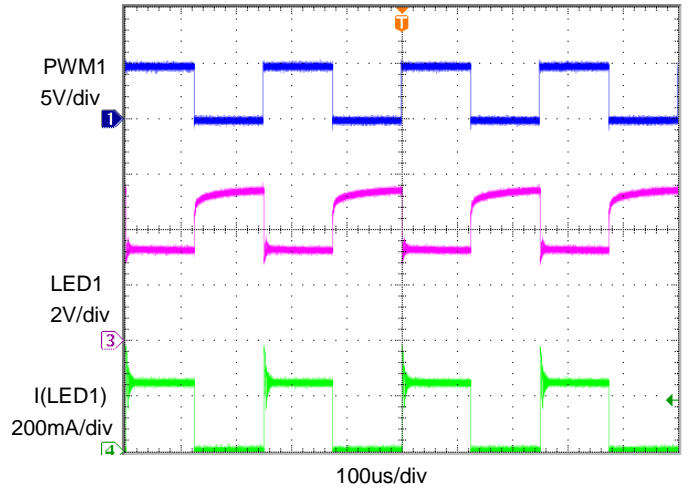

**Figure 7 Dimming by PWM Input (PWM1 4KHz)**

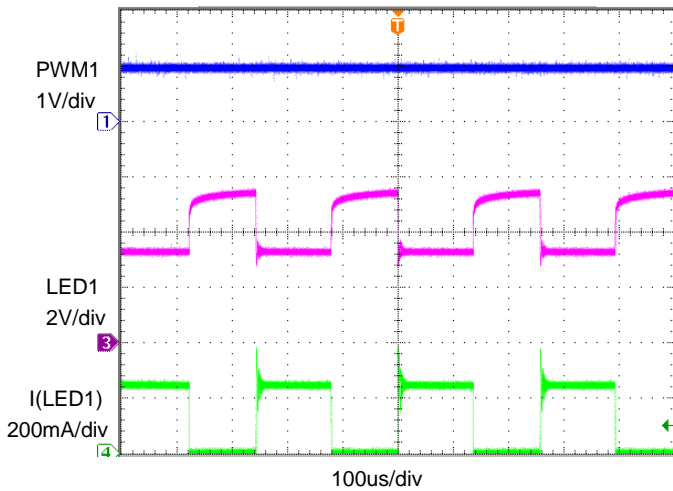

**Figure 8 Dimming by Analog input ( V(PWM1)=1V )**

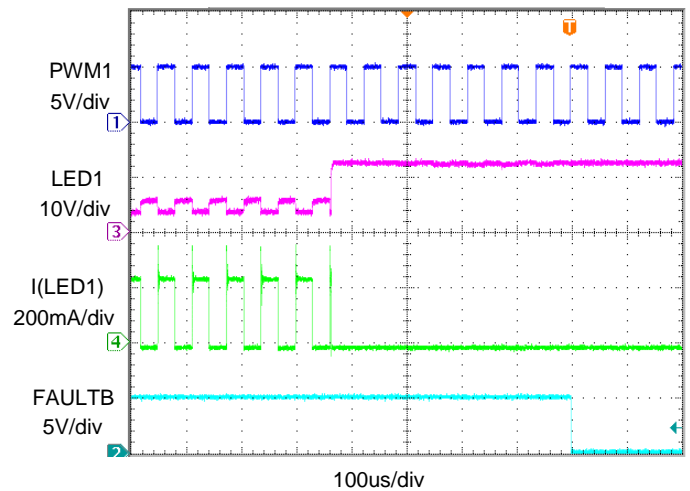

**Figure 9 LED Short Protect Deglitch Cycles**

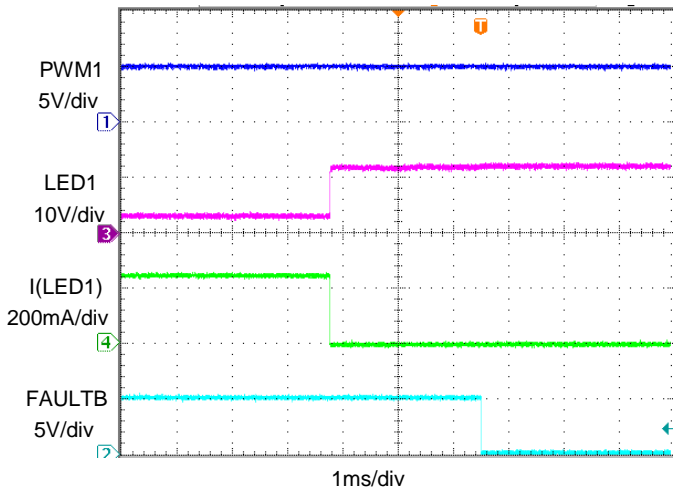

**Figure 10 LED Short Protect Deglitch Time**

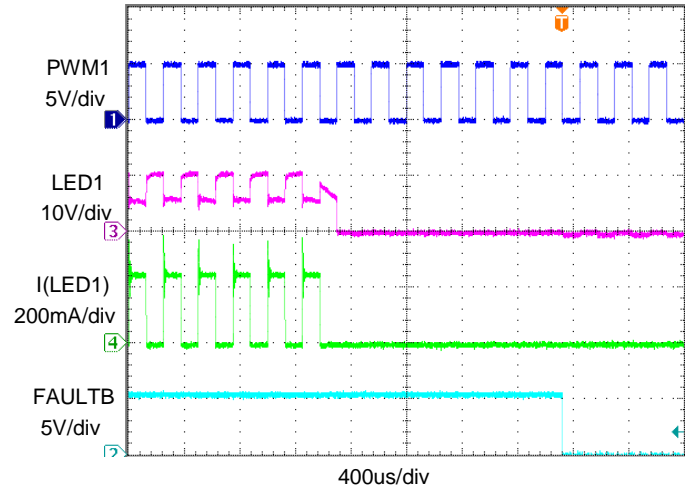

**Figure 11 LED Open Protect Deglitch Cycles**

**Typical Performance Characteristics** (continued)



Figure 12 LED Open Protect Deglitch Time



Figure 13 LEDx Current vs. V<sub>LEDx</sub>



Figure 14 Minimum LED Regulation Voltage vs. R<sub>SET</sub>

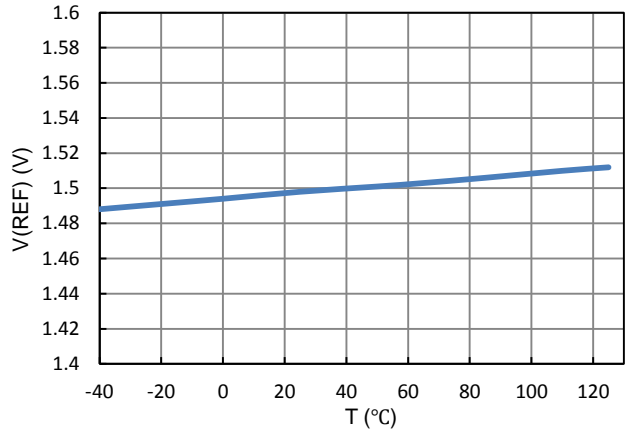

Figure 15 V(REF) vs. Temperature

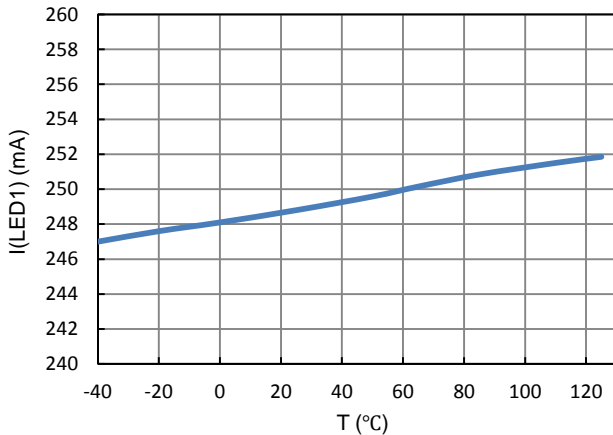

Figure 16 I(LED1) vs. Temperature

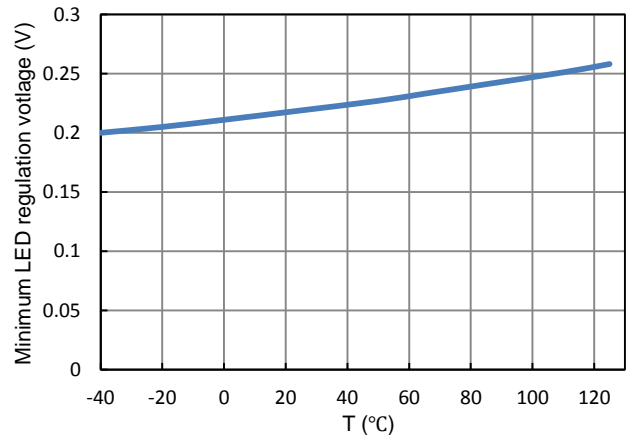

Figure 17 Minimum LED Regulation Voltage vs. Temperature

**Typical Performance Characteristics (cont.)**



Figure 18 PWM Linearity (1KHz)



Figure 19 PWM Linearity (1KHz, sub-10%)



Figure 20 PWM Linearity (1KHz, sub-1%)



Figure 21 PWM Linearity (4KHz)



Figure 22 PWM Linearity (4KHz, sub-10%)



Figure 23 PWM Linearity (4KHz, sub-1%)

**Typical Performance Characteristics (cont.)**

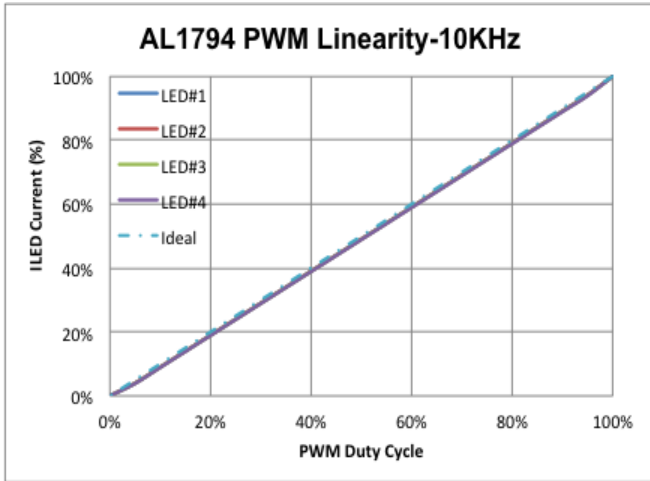

Figure 24 PWM Linearity (10KHz)

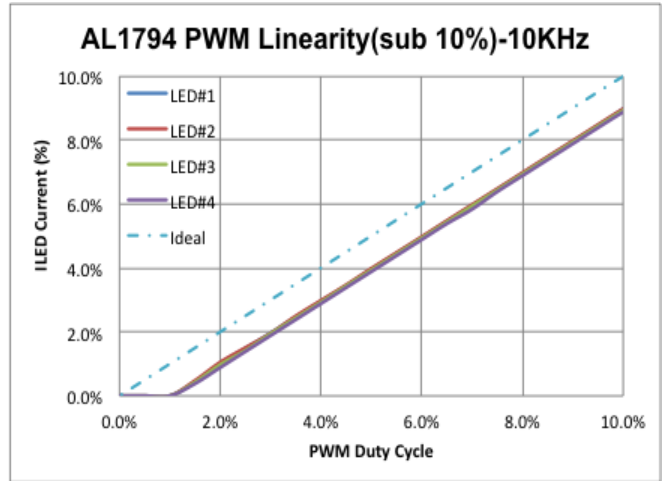

Figure 25 PWM Linearity (10KHz, sub-10%)

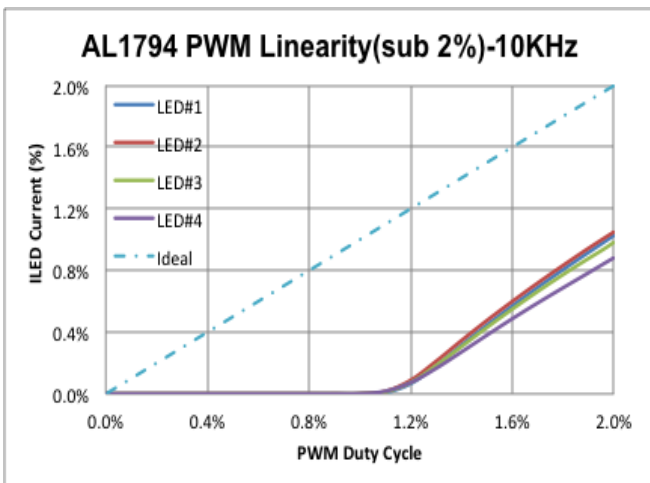

Figure 26 PWM Linearity (10KHz, sub-2%)

## Application Information

### Examples of Smart Light Bulb and LED Panel Light System Configurations

Emerging smart LED light bulbs, including Tunable White and Tunable Color products used in either wired or wireless control applications, address human needs for energy saving, light quality scene setting and entertainment light management. A typical block diagram of a smart light bulb consists of four major functional blocks: AC to DC Power Conversion, Wireless/Color Management MCU, an LED driver and an emitter module. The AL179X family fits well with emerging Smart Connected Light bulbs illustrated as below:

- 1-Channel Dimmable White (Figure 2)                      Brightness adjustment with Fixed Correlated Color Temperature (CCT) White
- 2-Channel Tunable White (Figure 3)                      CCT Tuning with range from 2,700K to 6,500K
- 3-Channel Tunable Color (Figure 4)                      Color Mixing for CCT White Generation and Tunable RGB
- 4-Channel White with Tunable Color (Figure 5)              Main White Light with Tunable RGB

For wireless-enabled Smart Connected LED Panel Lights, Troffers, and Ceiling Lights, AL1791/2 can be used to drive emitter string(s) for either 1-channel Dimmable White or 2-channel Tunable White applications as shown in Figure 2 and Figure 3.

### Interface with AC to DC Power Conversion and AL179x

The AC to DC Power Conversion provides necessary output constant voltages (CVs) to power the MCU, and the LED Driver blocks of the entire smart light bulbs. Typical applications for smart light bulbs might require 3.3V for MCU and 12/24V for LED emitter strings of mainstream smart light bulbs. Anodes of top LED emitter strings are connected to a 12/24V power supply, and cathodes of bottom LED emitter strings are connected to LEDx pins of AL179x.

### Interface with Wireless/Color Management MCU and AL179x

The main physical interfaces between MCU and AL179x include EN, PWMx pins, and FAULTB. MCU activates the EN (asserted high) to turn on AL179x in active state for normal LED lighting operation. When EN pin is asserted low, the entire AL1794 enters into shutdown state with minimum power consumption. For typical light dimming or mixing operations, MCU generates proper PWM signal output through PWMx pins. In case of any general fault occurring in AL179x, FAULTB pin is asserted LOW to interrupt MCU for proper actions.

### LED Driver Design Topology and Implementation

AL179x-powered LED Driver/Emitter block adopts a multi-channel LED driver structure with either analog or PWM dimming control for each channel. The parallel LED driver channel structure covers mainstream applications for Smart Connected Lighting products. Given the maximum allowable input voltage of 30V, AL179x can support an LED string up to 8 emitters of W, B, G (assuming LED Emitter Forward Voltage Drop,  $V_F \sim 3.1V$ ) or 10 emitters of R (assuming  $V_F \sim 2.2V$ ) in series.

For 1-channel Dimmable White (Figure 2), the Reference Current ( $I_{REF}$ ) of AL179x is set by an external resistor  $R_{SET}$ . In the case using 10K $\Omega$  as  $R_{SET}$ , Channel 1 of AL1791 will be driving emitter string(s) with a total constant current of 600mA.

As an example of a 2-channel Tunable White light bulb design (Figure 3), an AL1792 drives two emitter strings, namely, CCTcold (6,500K) and CCTwarm (2,700K). Using an  $R_{SET}$  of 8.5K $\Omega$ , the maximum current for Channel 1 and Channel 2 will be 353mA if each PWM signal is turned on. The associated MCU could generate suitable PWM patterns to meet the required CCT tuning to target light output.

In the case of 3-channel Tunable Color light bulb, AL1794 (Figure 4) drives three separate channels attached to different color emitters (Green - Channel 1, Red - Channel 2, and Blue - Channel 3). The additional channel (Channel 4 in the example) could be connected to Channel 1 to enhance green light output. Any given CIE coordinates within the Color Triangle formed by CIE coordinates of three color emitters can be generated by proper PWM signal pattern generated by the MCU. Therefore, CCT white light tuning tracing the CIE Planckian Locus could be achieved.

In the case of 4-channel White RGB light bulb (Figure 5), combination of AL1791 and AL1793 ICs are used to drive four separate emitter strings, White, Green, Red, and Blue emitters. This system configuration provides more flexibility in channel current settings and higher white light output.

## Application Information (continued)

### Support Higher Current

While the recommended maximum I<sub>LED1</sub> is at 500mA for AL1792/1793/1794, by setting R<sub>SET</sub> at 6KΩ, the system design can drive an LED string with higher current by connecting the cathodes of the LED emitter string to two or more LED channel outputs (LED<sub>x</sub>) and associated PWM pins (PWM<sub>x</sub>) with the same PWM signal from the MCU. The result current through the LED emitter string is the sum of each current through the individual channels. For example, one can achieve a total of 1.5A by connecting the only one LED emitter string to all four LED channel outputs AL1793 or AL1794 for a fixed CCT lighting application.

Similarly, it is also possible to further increase the current for a specific channel by connecting two or more AL179x IC chips in parallel and drive all associated PWM pins with a common PWM signal.

### Dimming Performance

For PWM-dimmed light sources, there are two important performance aspects to pay attention to, namely, PWM frequency and deep dimming performance. While human eyes cannot discern any flickering caused by PWM-dimming light sources over 200Hz, electronic devices such as cameras for smartphones can detect flickering (referred to as e-Flicker) caused by certain much higher PWM-dimmed light sources. Generally speaking, the higher the PWM dimming signals applied to the light source, the less e-Flicker is detected by electronic components. The Smart Light bulb design could leverage the fast response time enabled by AL179x by applying PWM signals over 4KHz, which has been experimented to be free of e-Flicker.

Measured light is linearly proportional to the measured current and PWM duty cycle. The perceived light by human eyes has a non-linear relationship with measured light. Human eyes are also found to be more sensitive to low light situations. For example, 10% measured light is perceived to be 32% of the original full light. 5% measured light is perceived to be 22% of the original full light. 1% measured light is perceived to be 10% of the original full light. Therefore, deeper dimming such as less-than 0.4% at 4KHz PWM frequency can save significant energy as well as to provide adequate visible light output.

### Special System Design Considerations

Three key Smart Light Bulb system design issues need to be carefully planned for system efficiency consideration. Any headroom voltage (over total voltage drops for all LED emitters in a string) in each channel will result in additional power consumption for AL179x, which needs to be dissipated by AL179x. System designers are advised to carefully plan for forward-voltage-matched LED strings with Constant Voltage (CV) regulators to ensure that AL179x can properly dissipate heat for normal operations.

- (1) **V<sub>F</sub> Matching for Emitter Strings:** It is crucial to match the total forward voltage drop (V<sub>F</sub>) of each LED string attached to a CV for optimal system efficiency.
- (2) **Multiple CVs to Match Emitter Module Design:** The AC to DC Power Conversion block may need to support multiple CV outputs to power all emitter strings in a Smart Light Bulb design.
- (3) **Overall Thermal Management:** Though there are various protection mechanisms built into AL179x, it is good practice to check the maximum dimming patterns to avoid Thermal Shutdown (when AL179x junction temperature exceeds +160°C). Thermal resistivity θ<sub>ja</sub> (Junction-to-Ambient) of AL179x is +55°C/Watt. AL179x has to absorb any additional voltage headroom provided by the voltage input to the emitter strings. Therefore, thermal management of AL179x must follow the following guidelines:

- PD<sub>max</sub> (Maximum Power Dissipation of AL179x) = (160°C Junction Shutdown Temperature - Ambient Temperature, e.g. 85°C) / 55°C/W = 1.364Watts
- PA<sub>max</sub> (Power to be Absorbed by AL179x) = Σ(V<sub>LEDx</sub> \* Current through the emitter string \* Associated PWM Dimming Duty Cycle) for all channels
- Thermal Management Guideline PA<sub>max</sub> < PD<sub>max</sub>

**Ordering Information**

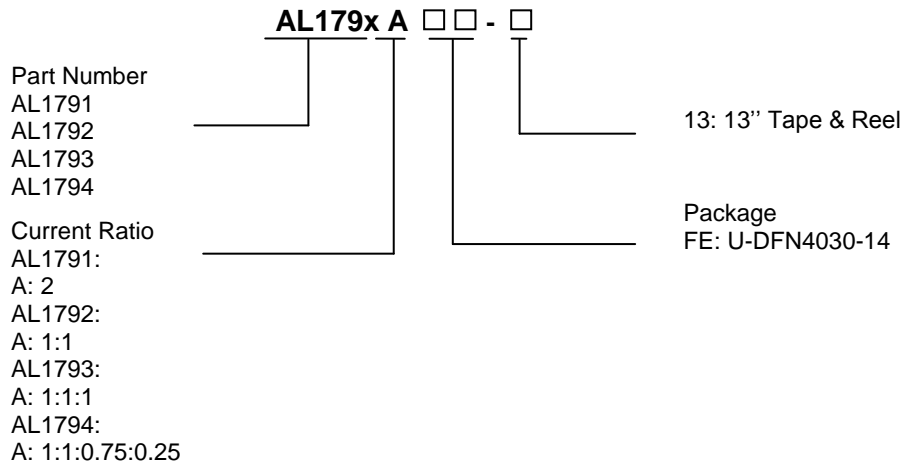

Part Number	Package Code	Packaging	13" Tape and Reel	
			Quantity	Part Number Suffix
AL1791AFE-13	FE	U-DFN4030-14 (Note 6)	3,000/Tape & Reel	-13
AL1792AFE-13	FE	U-DFN4030-14 (Note 6)	3,000/Tape & Reel	-13
AL1793AFE-13	FE	U-DFN4030-14 (Note 6)	3,000/Tape & Reel	-13
AL1794AFE-13	FE	U-DFN4030-14 (Note 6)	3,000/Tape & Reel	-13

Note: 6. For packaging details, go to our website at <http://www.diodes.com/products/packages.htm>.

**Marking Information**

(1) U-DFN4030-14

**( Top View )**

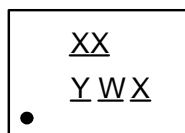

XX : Identification Code  
Y : Year : 0~9  
W : Week : A~Z : 1~26 week;  
a~z : 27~52 week;  
z : represents 52 and 53  
X : Internal Code

Part Number	Package	Identification Code
AL1791AFE	U-DFN4030-14	ZS
AL1792AFE	U-DFN4030-14	AM
AL1793AFE	U-DFN4030-14	PR
AL1794AFE	U-DFN4030-14	RZ

**Package Outline Dimensions** (All dimensions in mm.)

Please see AP02002 at <http://www.diodes.com/datasheets/ap02002.pdf> for the latest version.

(1) Package type: U-DFN4030-14

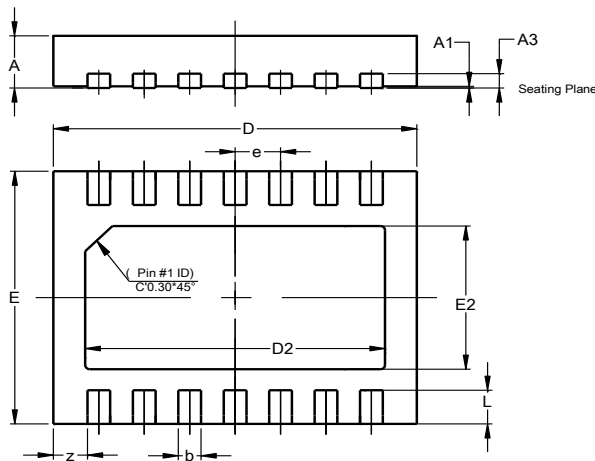

U-DFN4030-14			
Dim	Min	Max	Typ
A	0.55	0.65	0.60
A1	0.00	0.05	0.02
A3	-	-	0.15
b	0.20	0.30	0.25
D	3.95	4.05	4.00
D2	3.20	3.40	3.30
E	2.95	3.05	3.00
E2	1.60	1.80	1.70
e	-	-	0.50
L	0.35	0.45	0.40
z	-	-	0.375
All Dimensions in mm			

**Suggested Pad Layout**

Please see AP02001 at <http://www.diodes.com/datasheets/ap02001.pdf> for the latest version.

(1) Package type: U-DFN4030-14

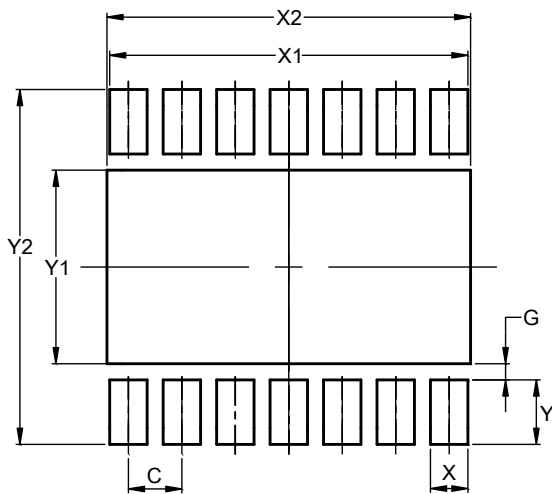

Dimensions	Value (in mm)
C	0.500
G	0.150
X	0.350
X1	3.350
X2	3.400
Y	0.600
Y1	1.800
Y2	3.300



## Taping Orientation

(1) Package type: U-DFN4030-14 (Note 7)



Note: 7. The taping orientation of the other package type can be found on our website at <http://www.diodes.com/datasheets/ap02007.pdf>.

**IMPORTANT NOTICE**

DIODES INCORPORATED MAKES NO WARRANTY OF ANY KIND, EXPRESS OR IMPLIED, WITH REGARDS TO THIS DOCUMENT, INCLUDING, BUT NOT LIMITED TO, THE IMPLIED WARRANTIES OF MERCHANTABILITY AND FITNESS FOR A PARTICULAR PURPOSE (AND THEIR EQUIVALENTS UNDER THE LAWS OF ANY JURISDICTION).

Diodes Incorporated and its subsidiaries reserve the right to make modifications, enhancements, improvements, corrections or other changes without further notice to this document and any product described herein. Diodes Incorporated does not assume any liability arising out of the application or use of this document or any product described herein; neither does Diodes Incorporated convey any license under its patent or trademark rights, nor the rights of others. Any Customer or user of this document or products described herein in such applications shall assume all risks of such use and will agree to hold Diodes Incorporated and all the companies whose products are represented on Diodes Incorporated website, harmless against all damages.

Diodes Incorporated does not warrant or accept any liability whatsoever in respect of any products purchased through unauthorized sales channel. Should Customers purchase or use Diodes Incorporated products for any unintended or unauthorized application, Customers shall indemnify and hold Diodes Incorporated and its representatives harmless against all claims, damages, expenses, and attorney fees arising out of, directly or indirectly, any claim of personal injury or death associated with such unintended or unauthorized application.

Products described herein may be covered by one or more United States, international or foreign patents pending. Product names and markings noted herein may also be covered by one or more United States, international or foreign trademarks.

This document is written in English but may be translated into multiple languages for reference. Only the English version of this document is the final and determinative format released by Diodes Incorporated.

**LIFE SUPPORT**

Diodes Incorporated products are specifically not authorized for use as critical components in life support devices or systems without the express written approval of the Chief Executive Officer of Diodes Incorporated. As used herein:

- A. Life support devices or systems are devices or systems which:
  - 1. are intended to implant into the body, or
  - 2. support or sustain life and whose failure to perform when properly used in accordance with instructions for use provided in the labeling can be reasonably expected to result in significant injury to the user.
- B. A critical component is any component in a life support device or system whose failure to perform can be reasonably expected to cause the failure of the life support device or to affect its safety or effectiveness.

Customers represent that they have all necessary expertise in the safety and regulatory ramifications of their life support devices or systems, and acknowledge and agree that they are solely responsible for all legal, regulatory and safety-related requirements concerning their products and any use of Diodes Incorporated products in such safety-critical, life support devices or systems, notwithstanding any devices- or systems-related information or support that may be provided by Diodes Incorporated. Further, Customers must fully indemnify Diodes Incorporated and its representatives against any damages arising out of the use of Diodes Incorporated products in such safety-critical, life support devices or systems.

Copyright © 2015, Diodes Incorporated

[www.diodes.com](http://www.diodes.com)