

Middle Power Class-D Speaker Amplifiers



Analog Input / Single End Output Class-D Speaker Amplifier

BD5445EFV

No.11075ECT16

●Overview

BD5445EFV is a Analog input type Class D Speaker Amplifier designed for Flat-panel TVs in particular for space-saving and low-power consumption, delivers an output power of 17W+17W. This IC employs state-of-the-art Bipolar, CMOS, and DMOS (BCD) process technology that eliminates turn-on resistance in the output power stage and internal loss due to line resistances up to an ultimate level. With this technology, the IC can achieve high efficiency of 91% (10W+10W output with 8Ω load). In addition, the IC is packaged in a compact reverse heat radiation type power package to achieve low power consumption and low heat generation and eliminates necessity of external heat-sink up to a total output power of 34W. This product satisfies both needs for drastic downsizing, low-profile structures and powerful, high-quality playback of sound system.

●Features

- 1) 17W stereo single-ended outputs
34W mono bridge-tied-load output
- 2) Wide supply voltage (From 10V to 27V)
- 3) Four selectable gain (14, 20, 26, 32dB)
- 4) Master / Slave function
- 5) Soft-start and Soft-mute
- 6) Low noise, Low distortion
- 7) Various protection functions
(High temperature, Output short, Under voltage)
- 8) Small power package (HTSSOP-B28)

●Applications

Flat Panel TVs (LCD, Plasma), Home Audio, Desktop PC, Amusement equipments, Electronic Music equipments, etc.

● Absolute maximum ratings (Ta=25°C)

Item	Symbol	Limit	Unit	Conditions
Supply voltage	V _{CC}	30	V	Pin 1, 15, 16, 27, 28 ※1 ※2
Power dissipation	P _d	1.45	W	※3
		3.30	W	※4
		4.70	W	※5
Input voltage for signal	V _{IN}	-0.3 ~ 5.3	V	Pin 4, 5 ※1
Input voltage for control	V _{CONT}	-0.3 ~ V _{CC} + 0.3	V	Pin 2, 3, 10, 11, 13 ※1
Input voltage for clock	V _{OSC}	-0.3 ~ 5.3	V	Pin 12 ※1
Operating temperature range	T _{opr}	-25 ~ +85	°C	
Storage temperature range	T _{stg}	-55 ~ +150	°C	
Maximum junction temperature	T _{jmax}	+150	°C	

※1 The voltage that can be applied, based on Gnd(Pin6, 20, 21, 22, 23)

※2 Do not, however exceed P_d and T_{jmax}=150°C.

※3 70mm × 70mm × 1.6mm, FR4, 1-layer glass epoxy board (Copper on bottom layer 0%)

Derating in done at 11.6mW/°C for operating above Ta=25°C.

※4 70mm × 70mm × 1.6mm, FR4, 2-layer glass epoxy board (Copper on bottom layer 100%)

Derating in done at 26.4mW/°C for operating above Ta=25°C. There are thermal via on the board.

※5 70mm × 70mm × 1.6mm, FR4, 4-layer glass epoxy board (Copper on bottom layer 100%)

Derating in done at 37.6mW/°C for operating above Ta=25°C. There are thermal via on the board.

● Operating conditions (Ta=25°C)

Item	Symbol	Limit	Unit	Conditions
Supply voltage	V _{CC}	10 ~ 27	V	Pin 1, 15, 16, 27, 28 ※1 ※2
Minimum load impedance	R _L	3.6	Ω	※6

※6 Do not, however exceed P_d.

※ No radiation-proof design

●Electrical characteristics (Unless otherwise specified Ta=25°C, Vcc=24V, f=1kHz, R_L=8Ω, Po=1W, Gain=20dB, PDX=24V, MUTEX=24V, MS=0V, Single-ended outputs)

Item	Symbol	Limit			Unit	Conditions
		Min	Typ	Max		
Whole circuit						
Circuit current 1	I _{CC1}	-	25	50	mA	Pin 1, 15, 16, 27, 28 No load, No signal
Circuit current 2 (Power down mode)	I _{CC2}	-	2	4	mA	Pin 1, 15, 16, 27, 28 PDX=0V, MUTEX=0V, No load, No signal
Control circuit						
High level input voltage for control	V _{IH}	2.5	-	24	V	Pin 2, 3, 10, 11, 13
Low level input voltage for control	V _{IL}	0	-	0.8	V	Pin 2, 3, 10, 11, 13
High level input voltage for clock	V _{IHC}	2.5	-	5	V	Pin 12
Low level input voltage for clock	V _{ILC}	0	-	0.8	V	Pin 12
Audio circuit						
Momentary maximum output power	P _{O1}	-	10	-	W	R _L =8Ω, THD+n=10% ※7
	P _{O2}	-	17	-		R _L =4Ω, THD+n=10% ※7
Voltage gain	G _{V0}	12	14	16	dB	Gain1=0V, Gain0=0V ※7
	G _{V1}	18	20	22		Gain1=0V, Gain0=24V ※7
	G _{V2}	24	26	28		Gain1=24V, Gain0=0V ※7
	G _{V3}	30	32	34		Gain1=24V, Gain0=24V ※7
Total harmonic distortion	THD	-	0.05	-	%	BW=20~20kHz ※7
Crosstalk	CT	60	75	-	dB	R _g =0Ω, BW=IHF-A ※7
Output noise voltage	V _{NO}	-	80	160	μVrms	R _g =0Ω, BW=IHF-A ※7
Residual noise voltage (Power down mode)	V _{NOR}	-	1	10	μVrms	PDX=0V, MUTEX=0V R _g =0Ω, BW=IHF-A ※7
Mute attenuation	G _{VM}	80	94	-	dB	MUTEX=0V, BW= IHF-A ※7
Power supply rejection ratio	PSRR	-	60	-	dB	Vripple=1Vrms, BW= IHF-A R _g =0Ω, fripple=100Hz ※7
Internal oscillation frequency	F _{OSC}	480	600	720	kHz	Pin 12, MS=0V ※7
External clock frequency	F _{EXT}	480	-	720	kHz	Pin 12, MS=24V ※7

※7 These items show the typical performance of device and depend on board layout, parts, power supply.
The standard value is in mounting device and parts on surface of ROHM's board directly.

● Typical Characteristics Data (SE × 2ch) Measured on ROHM's evaluation board.

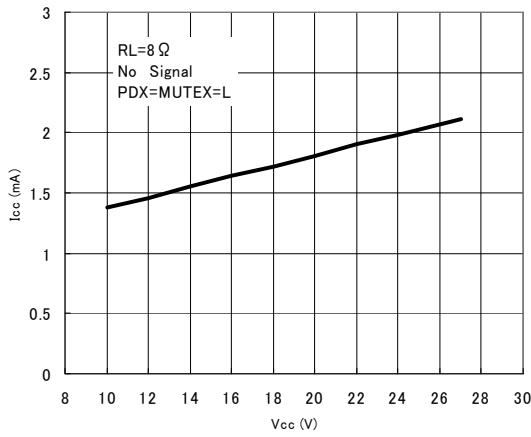

Fig. 1 Power supply voltage—Current consumption

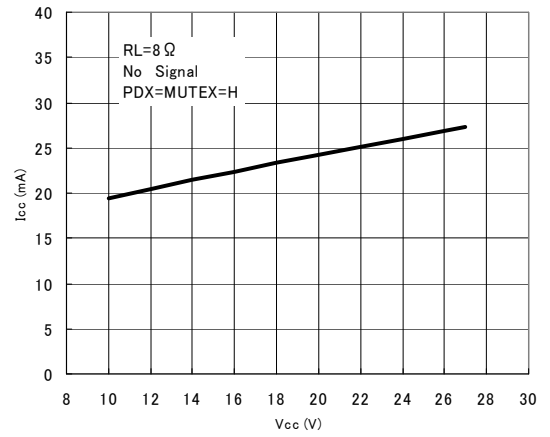

Fig. 2 Power supply voltage—Current consumption

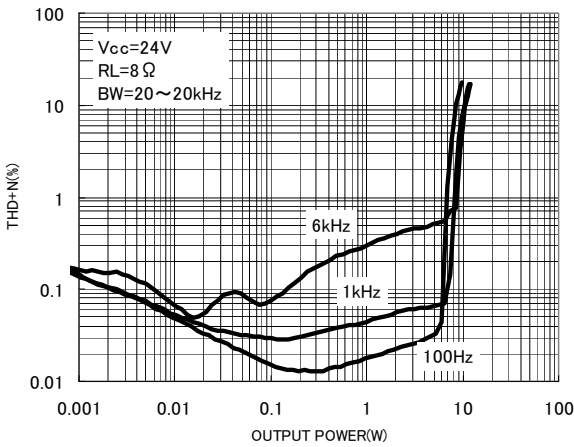

Fig.3 Output power—THD+N

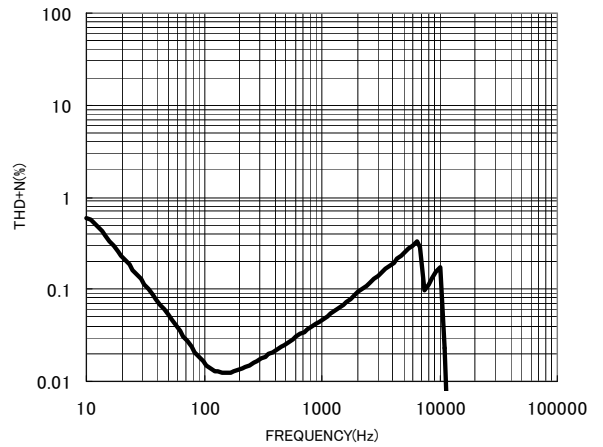

Fig.4 Frequency—THD+N

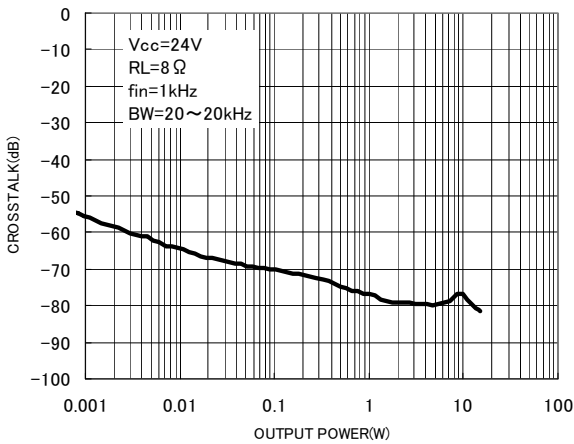

Fig.5 Output power—Crosstalk

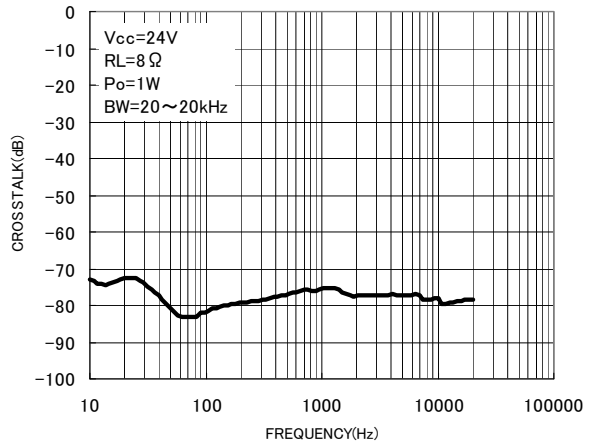

Fig.6 Frequency—Crosstalk

● Typical Characteristics Data (SE × 2ch) Measured on ROHM's evaluation board.

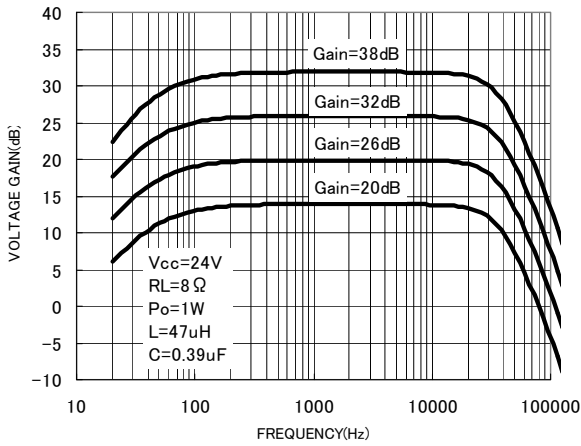

Fig.7 Frequency–Voltage gain

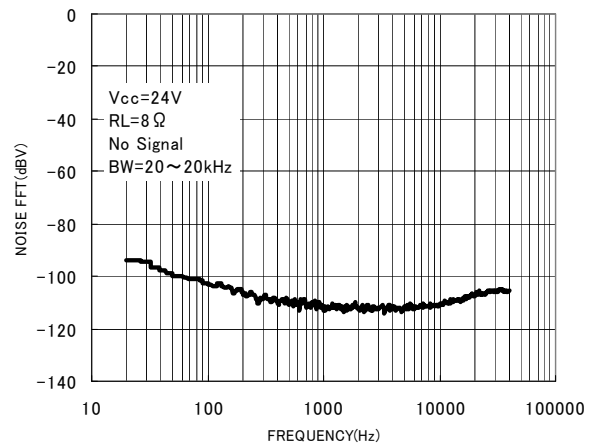

Fig.8 FFT of Output Noise Voltage

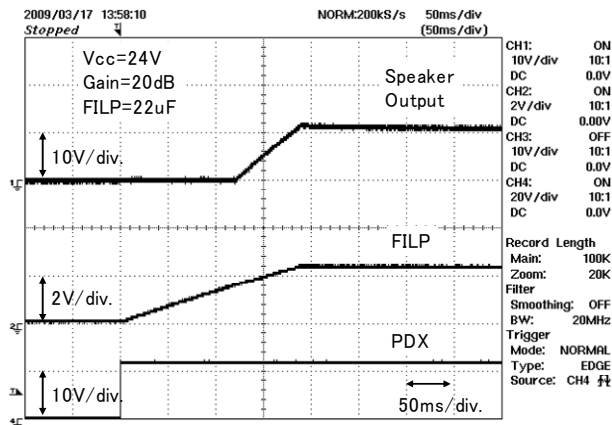

Fig.9 Waveform when releasing Power-down

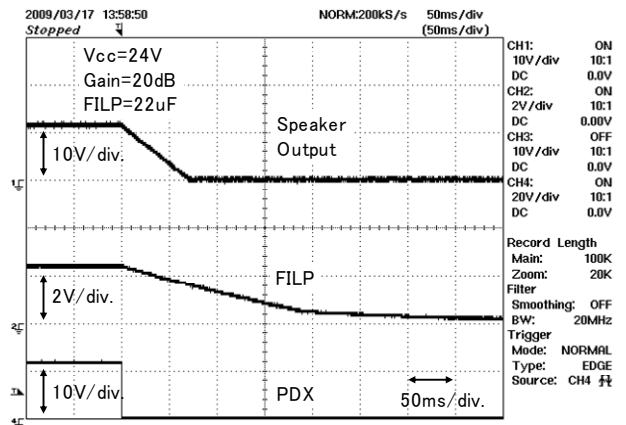

Fig.10 Waveform when activating Power-down

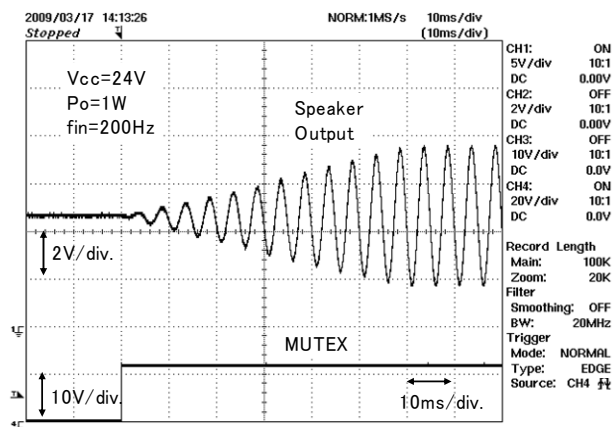

Fig.11 Waveform when releasing Soft-mute

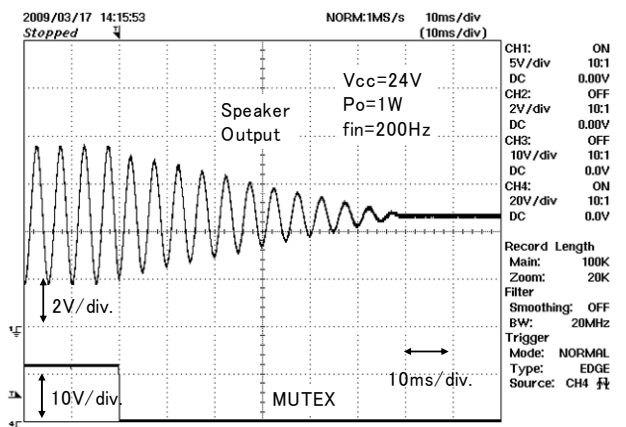

Fig.12 Waveform when activating Soft-mute

● Typical Characteristics Data (SE × 2ch) Measured on ROHM's evaluation board.

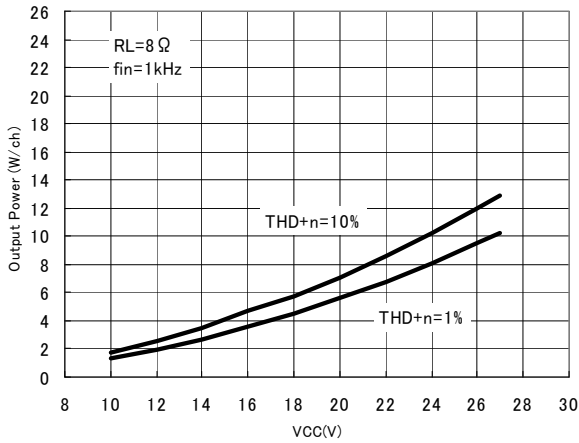

Fig.13 Power supply voltage—Output power (RL=8Ω)

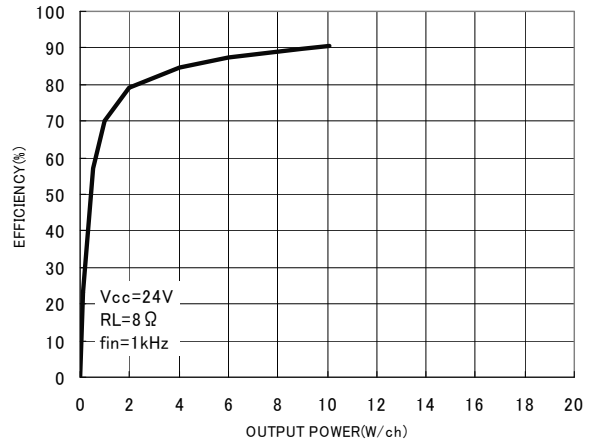

Fig.14 Output power—Efficiency (RL=8Ω)

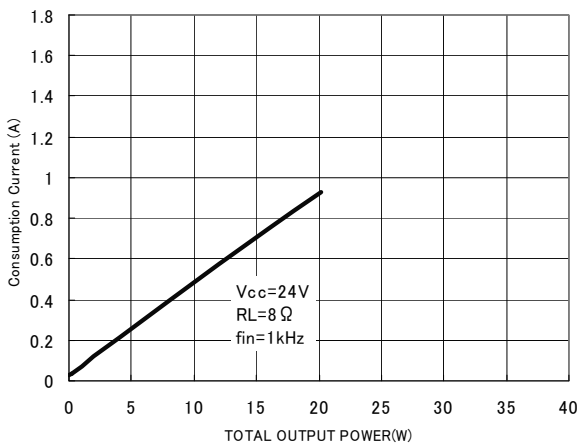

Fig.15 Total output power—Current consumption (RL=8Ω)

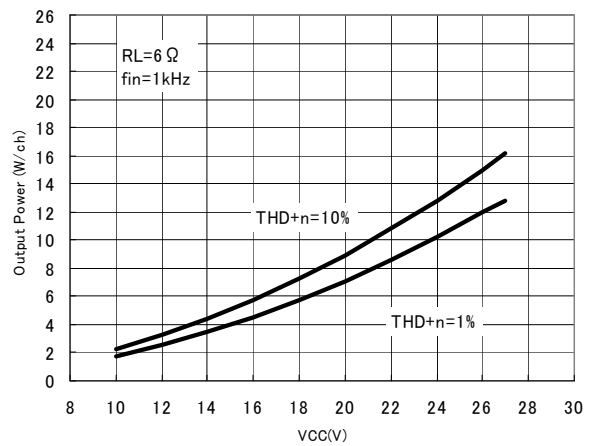

Fig.16 Power supply voltage—Output power (RL=6Ω)

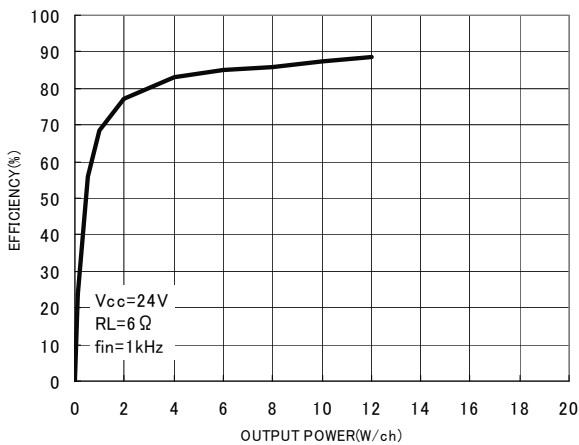

Fig.17 Output power—Efficiency (RL=6Ω)

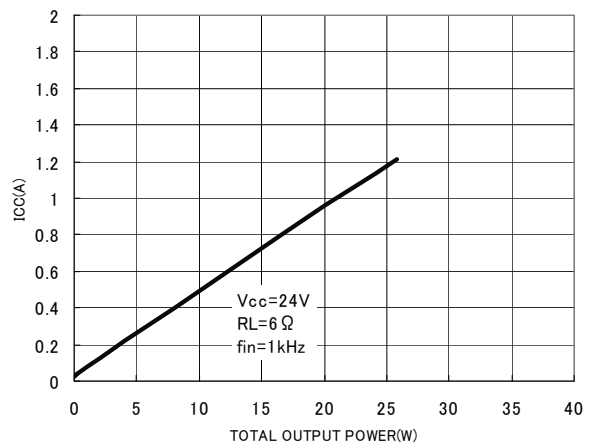

Fig.18 Total output power—Current consumption (RL=6Ω)

● Typical Characteristic Data (SE × 2ch) Measured on ROHM's evaluation board.
 Dotted lines of the graphs indicate continuous output power by installing additional heat sinks.

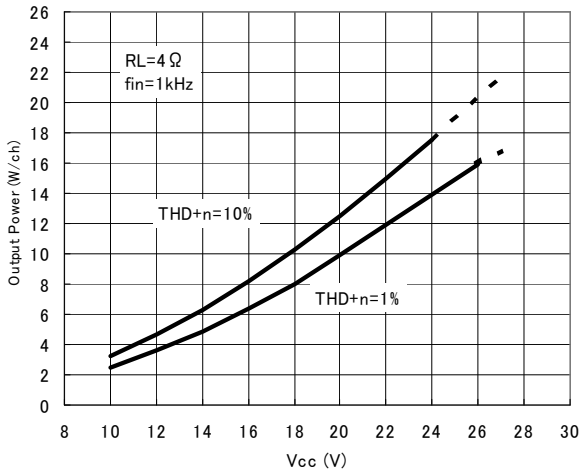

Fig.19 Power supply voltage—Output power ($R_L=4\ \Omega$)

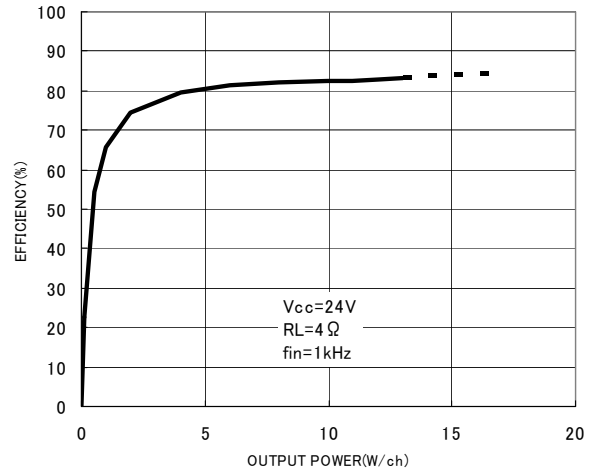

Fig.20 Output power—Efficiency ($R_L=4\ \Omega$)

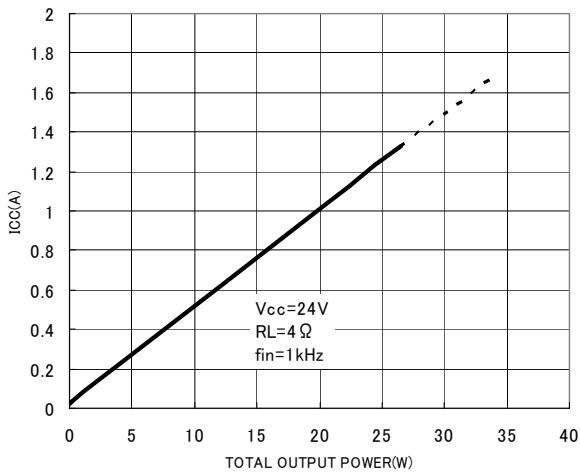

Fig.21 Total output power—Current consumption ($R_L=4\ \Omega$)

●Typical Characteristic Data (SE × 2ch) Measured on ROHM's evaluation board.
 Dotted lines of the graphs indicate continuous output power by installing additional heat sinks.

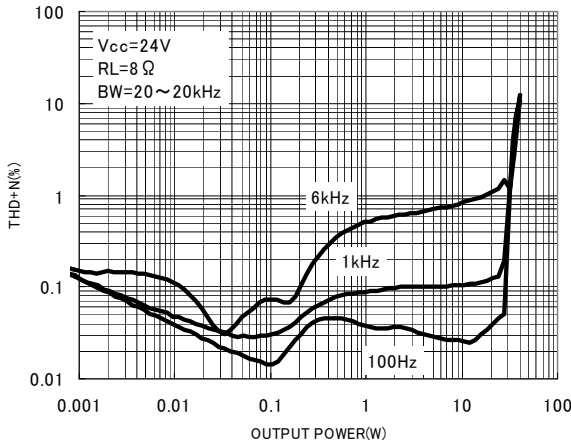

Fig.22 Output power—THD+n

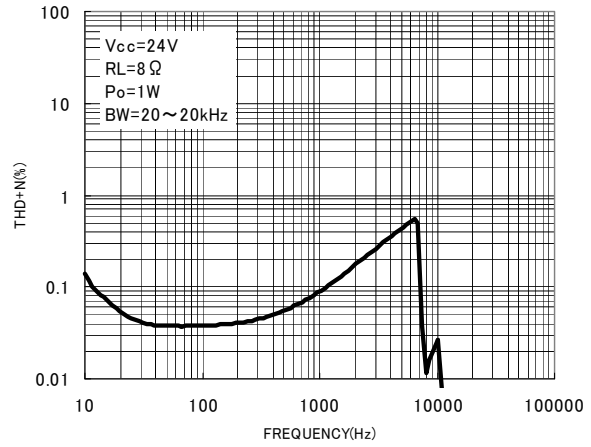

Fig.23 Frequency—THD+n

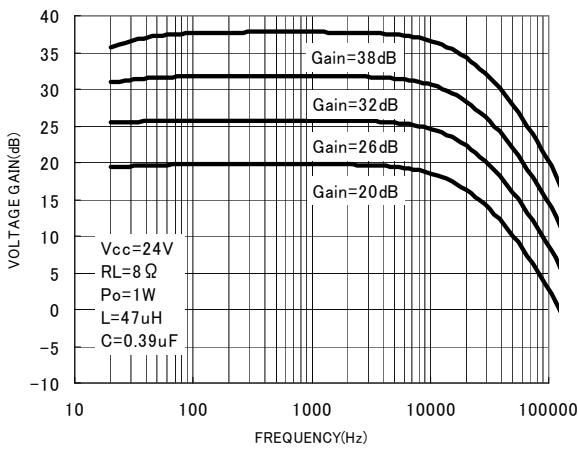

Fig.24 Frequency—Voltage gain

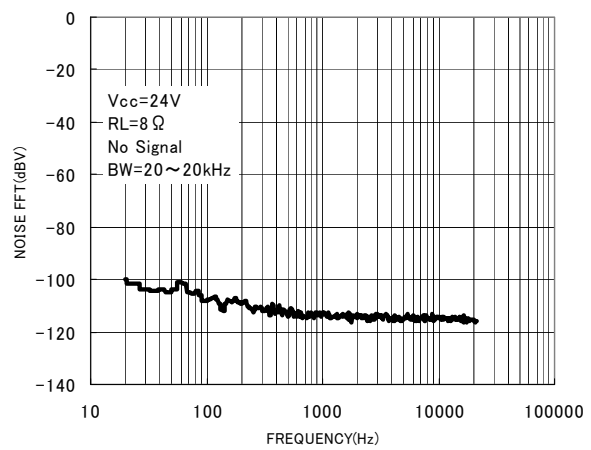

Fig.25 FFT of Output Noise Voltage

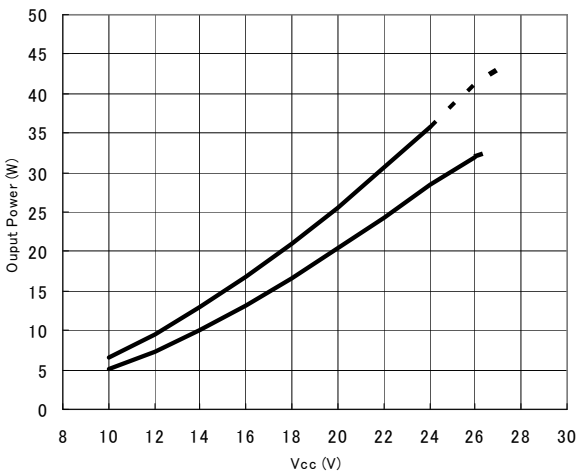

Fig.26 Power supply voltage—Output power ($R_L=8\Omega$)

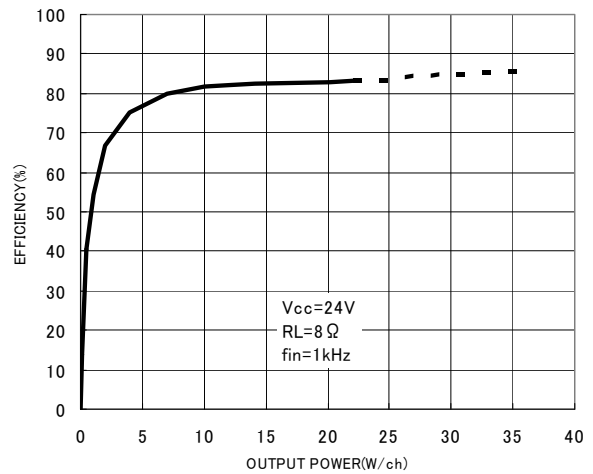

Fig.27 Output power—Efficiency ($R_L=8\Omega$)

● Typical Characteristics Data (BTL) Measured on ROHM's evaluation board.

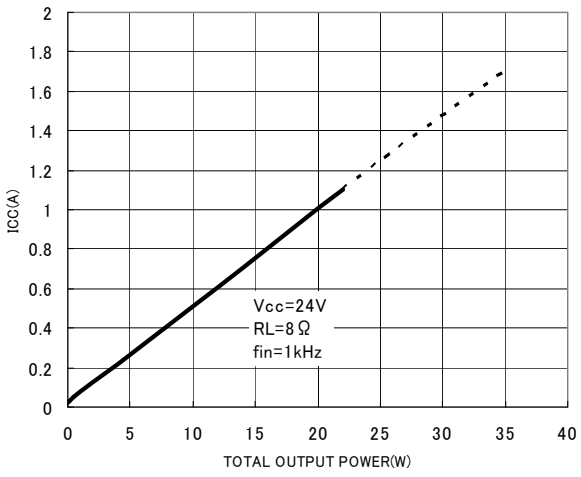
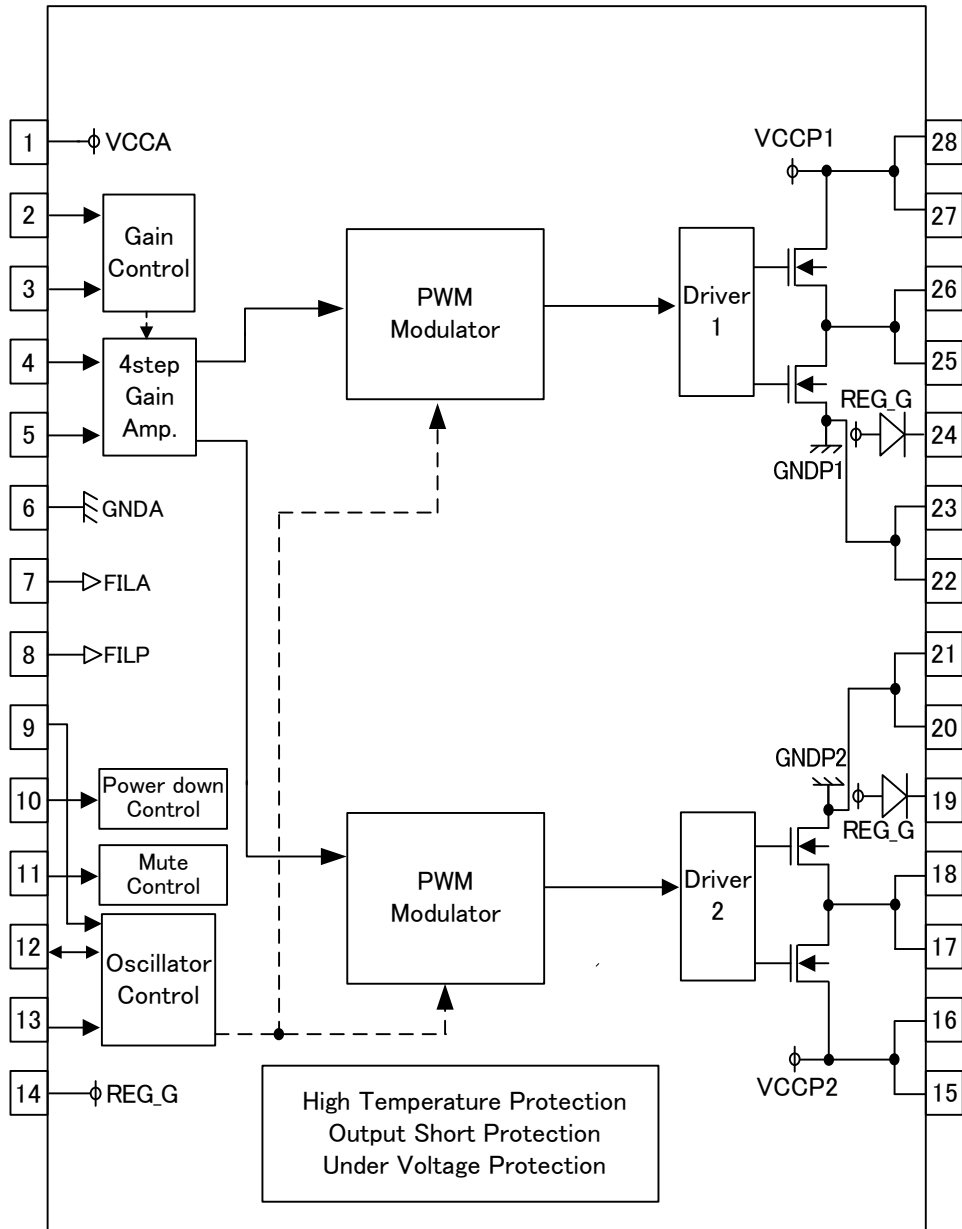

Fig.28 Total output power—Current consumption (R_L=8Ω)

● Pin configuration and Block diagram



● Pin function explanation (Provided pin voltages are typ. values)

Pin No.	Pin name	Pin voltage	Pin explanation	Internal equivalence circuit
1	VCCA	Vcc	Power supply pin for Analog signal	
2 3	GAIN0 GAIN1	—	Gain control pin	
4 5	IN1 IN2	2.5V	ch1 Analog signal input pin ch2 Analog signal input pin Input audio signal via a capacitor.	
6	GNDA	0V	Gnd pin for Analog signal	
7	FILA	2.5V	Bias pin for Analog signal Please connect the capacitor.	
8	FILP	2~4V	Bias pin for PWM signal Please connect the capacitor.	
9	ROSC	2.5V	Internal PWM sampling clock frequency setting pin Please connect the resistor setting Master mode. Please connect the capacitor setting Slave mode.	
10	PDX	—	Power down control pin H: Power down OFF L: Power down ON	

Pin No.	Pin name	Pin voltage	Pin explanation	Internal equivalence circuit
11	MUTEX	—	Speaker output mute control pin H: Mute OFF L: Mute ON	
12	OSC	—	PWM sampling clock input and output pin When using 2 or more ICs, connect to these pins.	
13	MS	—	Master mode and Slave mode control pin H: Slave mode L: Master mode	
14	REG_G	5.5V	Internal power supply pin for Gate driver Please connect the capacitor.	
15 16	VCCP2	Vcc	Power supply pin for ch2 PWM signal	
17 18	OUT2	0V~Vcc	Output pin of ch2 PWM Please connect to Output LPF.	
19	BSP2	5V	Boot-strap pin of ch2 Please connect the capacitor.	
20 21	GNDP2	0V	Gnd pin for ch2 PWM signal	

Pin No.	Pin name	Pin voltage	Pin explanation	Internal equivalence circuit
22 23	GNDP1	0V	Gnd pin for ch1 PWM signal	
24	BSP1	5V	Boot-strap pin of ch1 Please connect the capacitor.	
25 26	OUT1	0V~Vcc	Output pin of ch1 PWM Please connect to Output LPF.	
27 28	VCCP1	Vcc	Power supply pin for ch1 PWM signal	

●Audio input circuit (pin4 and pin5)

Connect the audio input pin with a prior-stage circuit via coupling capacitors C4 and C5. Because C4, C5 and input impedance R4, R5 of the IC circuit compose the primary HPF, the values determine an input low-band cutoff frequency. Input cutoff frequencies are calculated by the following formulas:

$$f_C = \frac{1}{2\pi R4 \cdot C4} [\text{Hz}] \quad f_C = \frac{1}{2\pi R5 \cdot C5} [\text{Hz}]$$

An excessively high capacitance of an input coupling capacitor results in a longer period required for stabilizing a power input pin voltage after turning on the power supply. Note that placing the MUTEX pin (pin11) at "L" level (mute turned off) for avoidance of Pop-noise before stabilizing an input pin. R4 and R5 are changed by Gain setting.

GAIN1 (3pin)	GAIN0 (2pin)	R4,R5 input impedance(TYP.)	Amplifier Gain (SE)	Amplifier Gain (BTL)
L	L	40kΩ	14dB	20dB
L	H	40kΩ	20dB	26dB
H	L	26.7kΩ	26dB	32dB
H	H	16kΩ	32dB	38dB

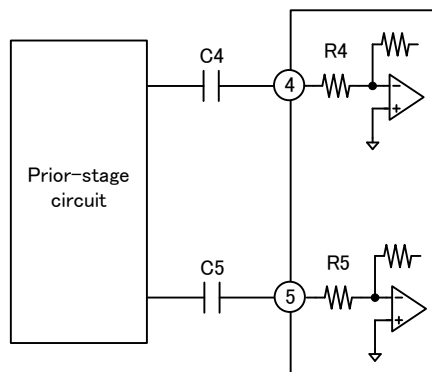

Fig. 29 Coupling capacitors of audio input pins

●Output LC Filter Circuit (Pins 17, 18, 25, and 26)

An output filter is required to eliminate radio-frequency components exceeding the audio-frequency region supplied to a load (speaker). Because this IC uses sampling clock between 480kHz and 720kHz in the output PWM signals, the high-frequency components must be appropriately removed.

This section takes an example of an LC type LPF, in which coil L_{fil} and capacitor C_{fil} compose a differential filter with an attenuation property of -12dB/oct. A large part of switching currents flow to capacitor C_{fil} , and only a small part of the currents flow to speaker R_L . The following is a table for output LC filter constants.

Speaker	R_L	$L_{fil}[\mu H]$	$C_{fil1}[\mu F]$	$C_{fil2}[\mu F]$
SE output	4 Ω	22	0.68	—
	6 Ω	33	0.47	—
	8 Ω	47	0.39	—
BTL output	4 Ω	15	0.22	1
	6 Ω	22	0.15	0.68
	8 Ω	33	0.1	0.47

In SE(single end) applications, the dc blocking capacitor (C_{se}) and speaker impedance compose the primary HPF. The cutoff frequency is determined by

$$f_C = \frac{1}{2\pi C_{SE} \cdot R_L} [\text{Hz}]$$

The following table is C_{se} setting at cutoff frequency 20Hz, 40Hz, and 60Hz.

R_L	$C_{SE}[\mu F]$		
	$f_c=60\text{Hz}$	$f_c=40\text{Hz}$	$f_c=20\text{Hz}$
4 Ω	680	1000	2200
6 Ω	470	680	1500
8 Ω	330	470	1000

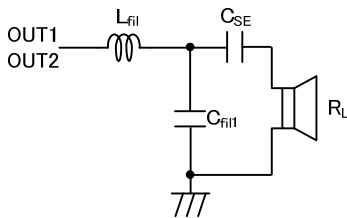

Fig.30 SE filter configuration

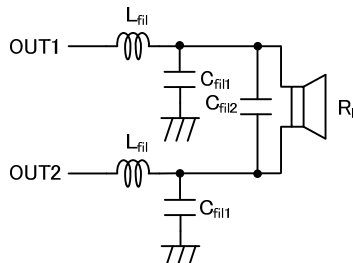

Fig.31 BTL filter configuration

●Control pins function

①GAIN0, GAIN1 function

GAIN1 (Pin 3)	GAIN0 (Pin 2)	Amplifier Gain (SE)	Amplifier Gain (BTL)
L	L	14dB	20dB
L	H	20dB	26dB
H	L	26dB	32dB
H	H	32dB	38dB

②MUTEX, PDX function

MUTEX (Pin 11)	PDX (Pin 10)	Speaker output	Power down
L	L	HiZ_Low	ON
L	H	Mute	OFF
H	H	Normal operation	OFF
H	L	Forbidden	

③MS function

MS (13pin)	Mode
L	Master mode
H	Slave mode

※Please connect ROSC terminal (pin 9) to 22kohm resistor for setting master mode.

※Please connect to the following filter, and input clock (duty = 50%) to OSC terminal (pin 12) for setting slave mode.

PWM Sampling frequency is sited from input clock. If input clock have noise (ex.Jitter), noise appear to Speaker output.

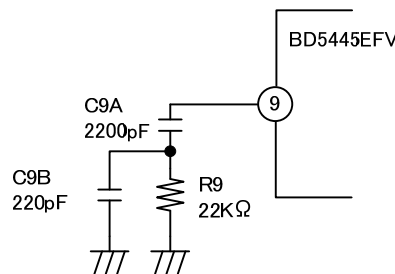

Fig.32 ROSC terminal filter circuit for setting slave mode.

※High level input voltage (Max.voltage) of tease control pin is equal to Vcc voltage. But absolute max.voltage of In0(pin4),ROSC(pin9),OSC(pin12) and REG_G(pin14) is 5.3V. Tease pins may break, when short next pins. If these pins short to Vcc, connecting through 10kΩ resistor prevent IC from destruction.

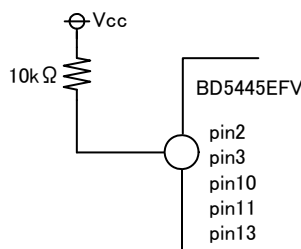
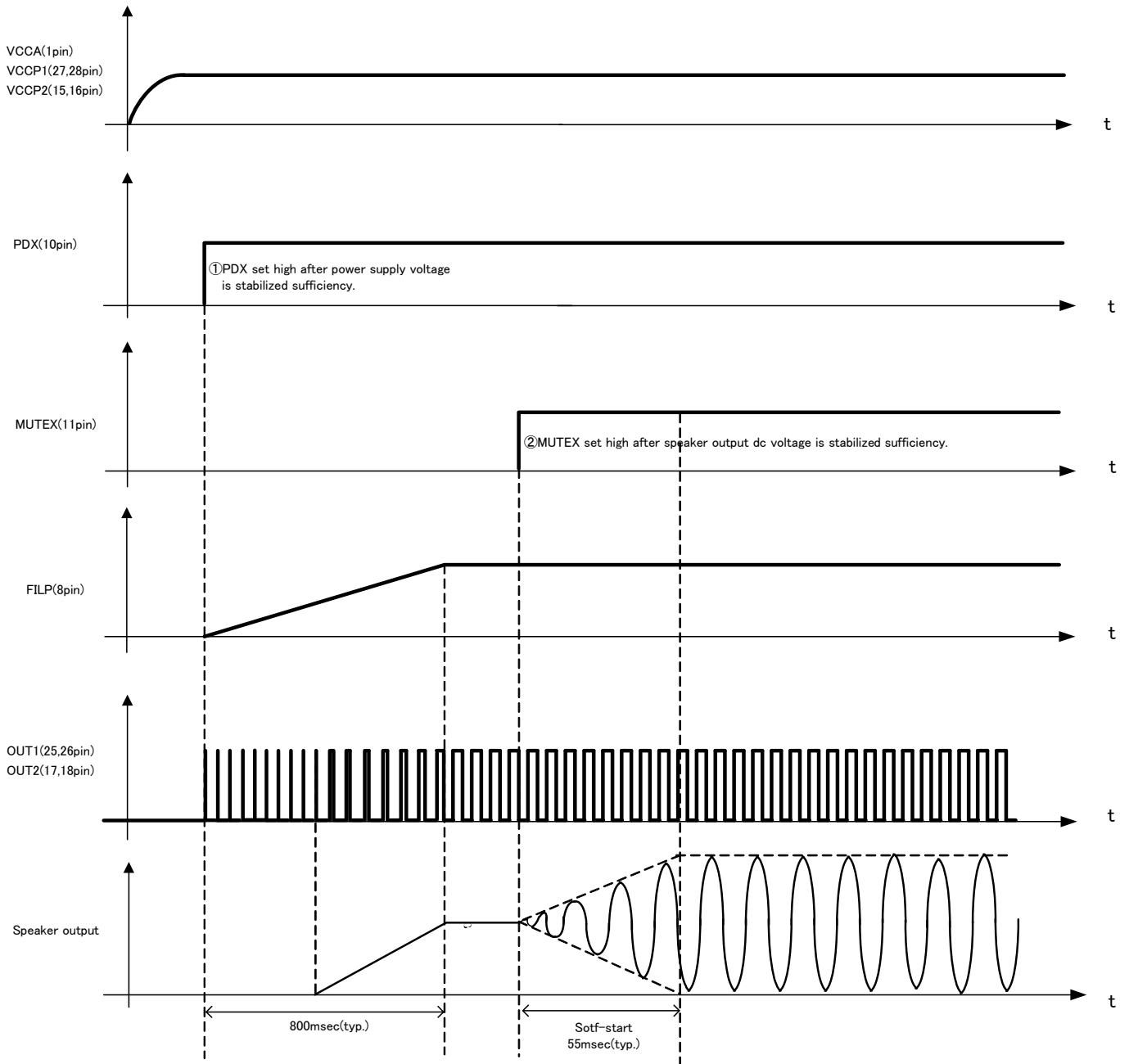
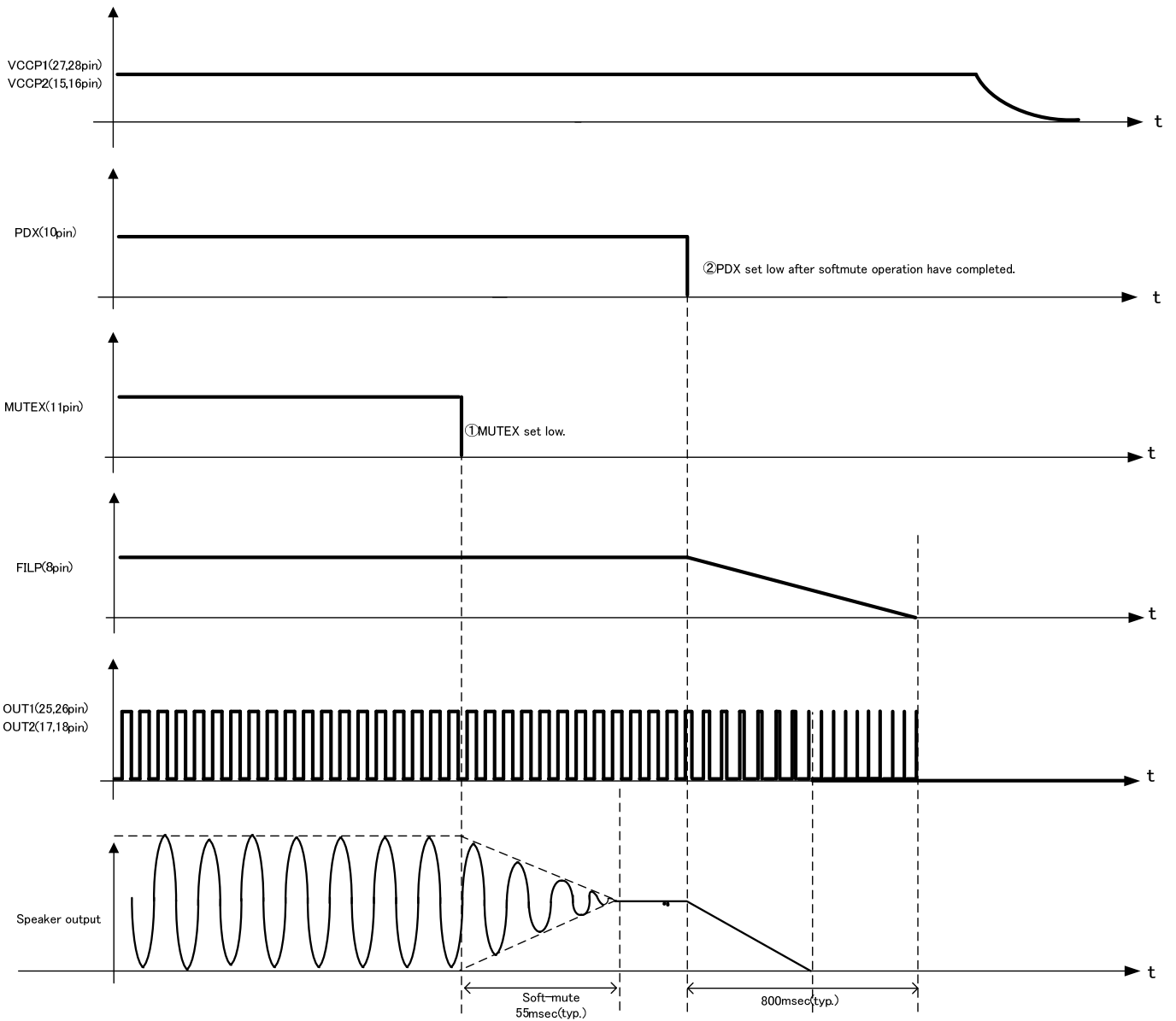

Fig.33

● Power supply start-up sequence



● Power supply shut-down sequence



Power supply shut down, after PDX (Pin 10) change H→L. The IC has possibly to sound POP noise, if PDX (Pim10) keep H. Speaker's coupling capacitor (Fig30:Cse) don't discharge at this time. Pop-noise may sound when power supply start up at the next time.

● Power supply start-up and shut-down sequence for single control

Short between PDX(Pin 10) and MUTEX(Pin 11), enable to control these pins at one time.

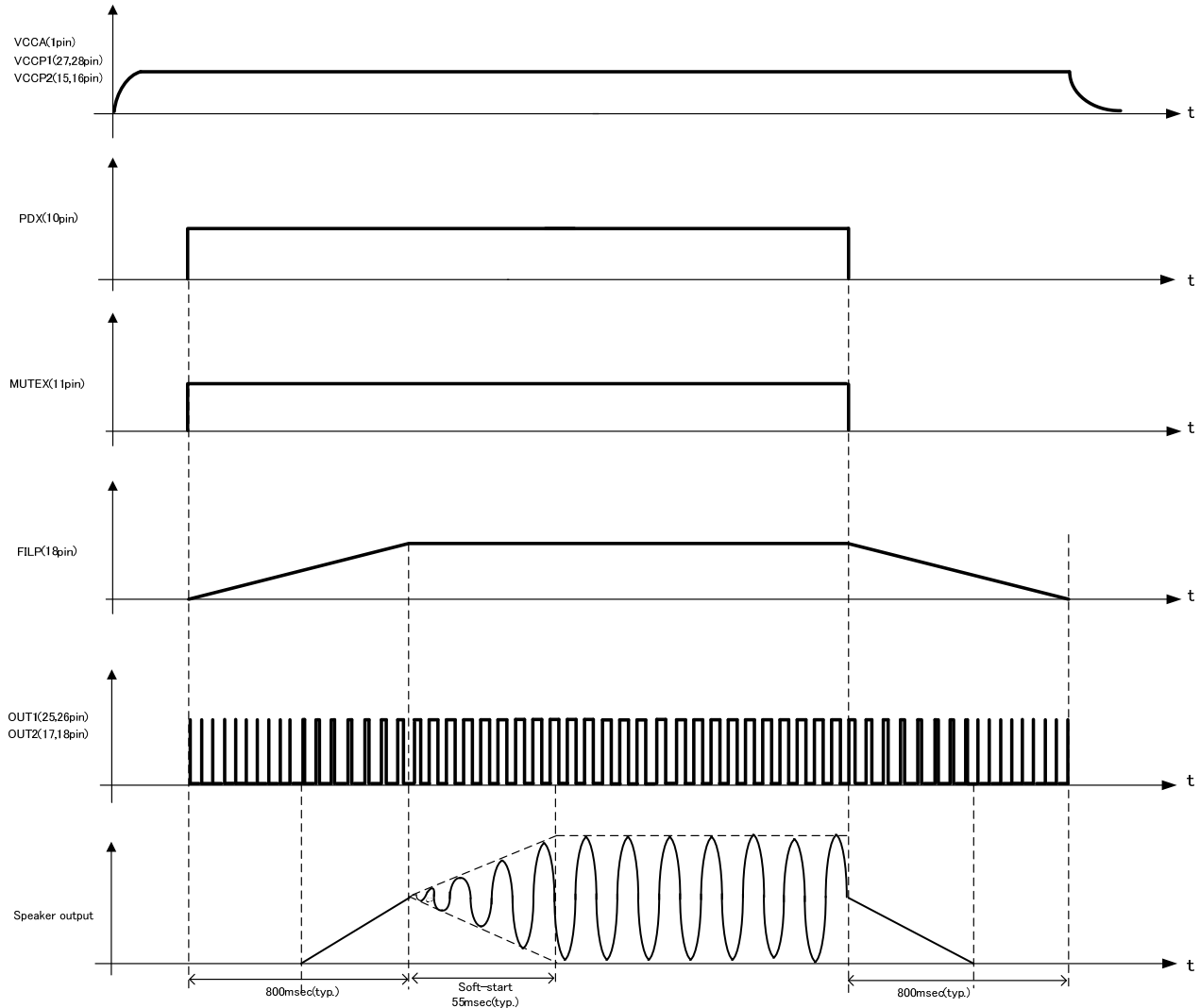

PDX (Pin 10) and MUTEX (Pin 11) set low at one time, while this IC is on normal mode, the IC don't operate soft-mute. If low frequency and high level signal input this time, the IC has possibility to sound POP-Noise. To avoid this POP-Noise configure the following circuit, because PDX (Pin10) enables to change low after MUTEX (Pin11) have changed. This sequence make less POP-Noise because the IC can operate soft-mute.

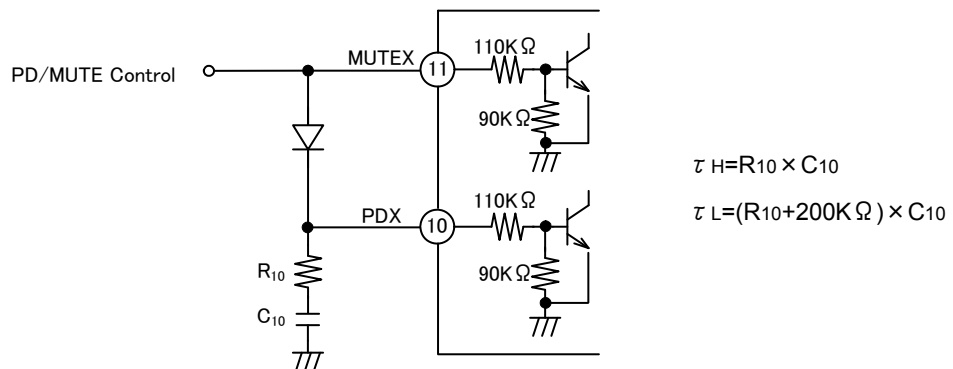

Control configuration for soft-mute operation by single control

●About the protection function

Protection function	Detecting & Releasing condition		PWM Output
Output short protection	Detecting condition	Detecting current = 10A (TYP.)	HiZ_Low
	Releasing condition	Release from Vcc or Gnd short	Normal operation
High temperature protection	Detecting condition	Chip temperature to be above 150°C (TYP.)	HiZ_Low
	Releasing condition	Chip temperature to be below 125°C (TYP.)	Normal operation
Under voltage protection	Detecting condition	Power supply voltage to be below 8V (TYP.)	HiZ_Low
	Releasing condition	Power supply voltage to be above 9V (TYP.)	Normal operation

※ All protection functions are restored automatically when the fault is removed.

1) Output short protection (Short to the power supply)

This IC has the output short protection circuit that stops the PWM output when the PWM output is short-circuited to the power supply due to abnormality.

Detecting condition – It will detect when PDX pin is set High and the current that flows in the PWM output pin becomes 10A(TYP.) or more. The PWM output instantaneously enters the state of HiZ-Low if detected, and IC does the latch.

Releasing method – This IC detect releasing from Vcc short every 220msec(TYP.). Normal operation is restored when releasing from Vcc short.

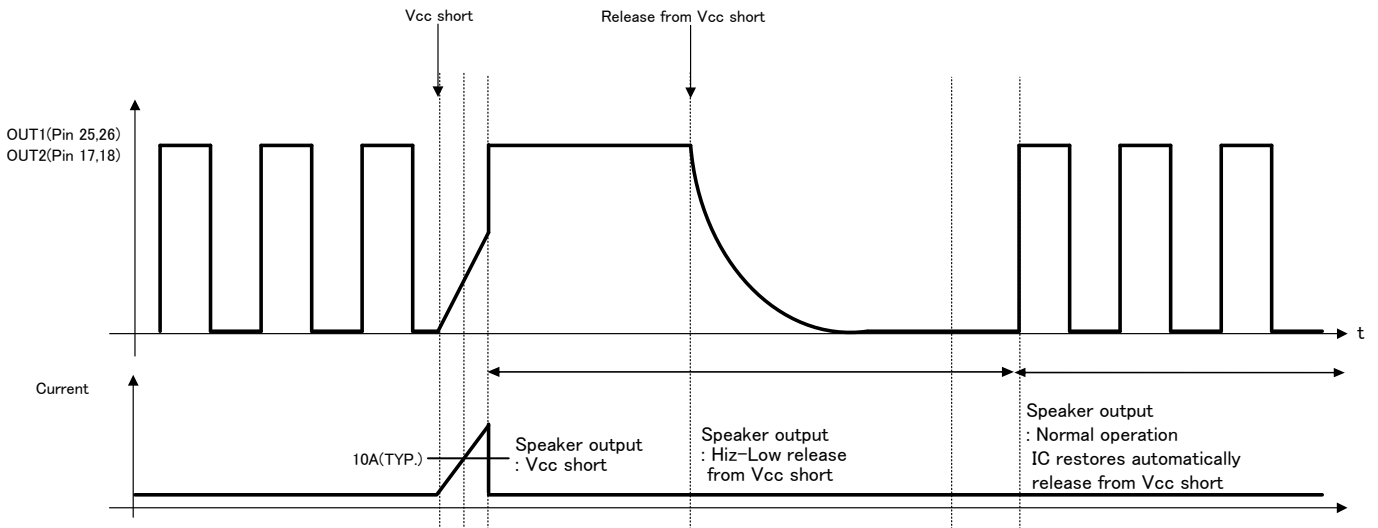

2) Output short protection (Short to Gnd)

This IC has the output short protection circuit that stops the PWM output when the PWM output is short-circuited to Gnd due to abnormality.

Detecting condition – It will detect when PDX pin is set High and the current that flows in the PWM output terminal becomes 10A(TYP.) or more. The PWM output instantaneously enters the state of HiZ-Low if detected, and IC does the latch.

Releasing method – This IC detect releasing from Gnd short every 220msec(TYP.). Normal operation is restored when releasing from Gnd short.

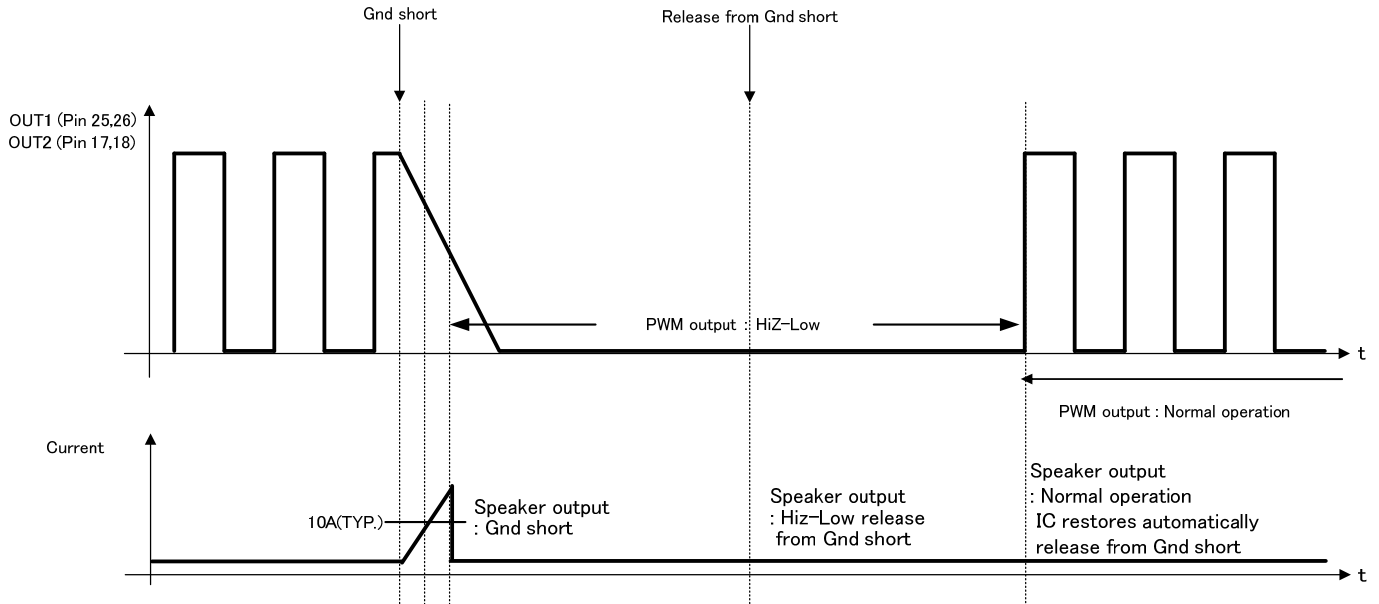

(※)Remark of output short protection

Circuit current changes suddenly, when IC detects output short protection. At this time IC may break, because supply voltage rise up by back electromotive force. Decoupling capacitors (VCCP1 and VCCP2) should be placed as close to the IC as possible. (recommend $4.7\mu\text{F}$ or more.)

3) High temperature protection

This IC has the high temperature protection circuit that prevents thermal reckless driving under an abnormal state for the temperature of the chip to exceed $T_{jmax}=150^{\circ}\text{C}$.

Detecting condition - It will detect when PDX pin is set High and the temperature of the chip becomes 150°C (TYP.) or more.
The speaker output is muted through a soft-mute when detected.

Releasing condition - It will release when PDX pin is set High and the temperature of the chip becomes 120°C (TYP.) or less.
The speaker output is outputted through a soft-start when released.

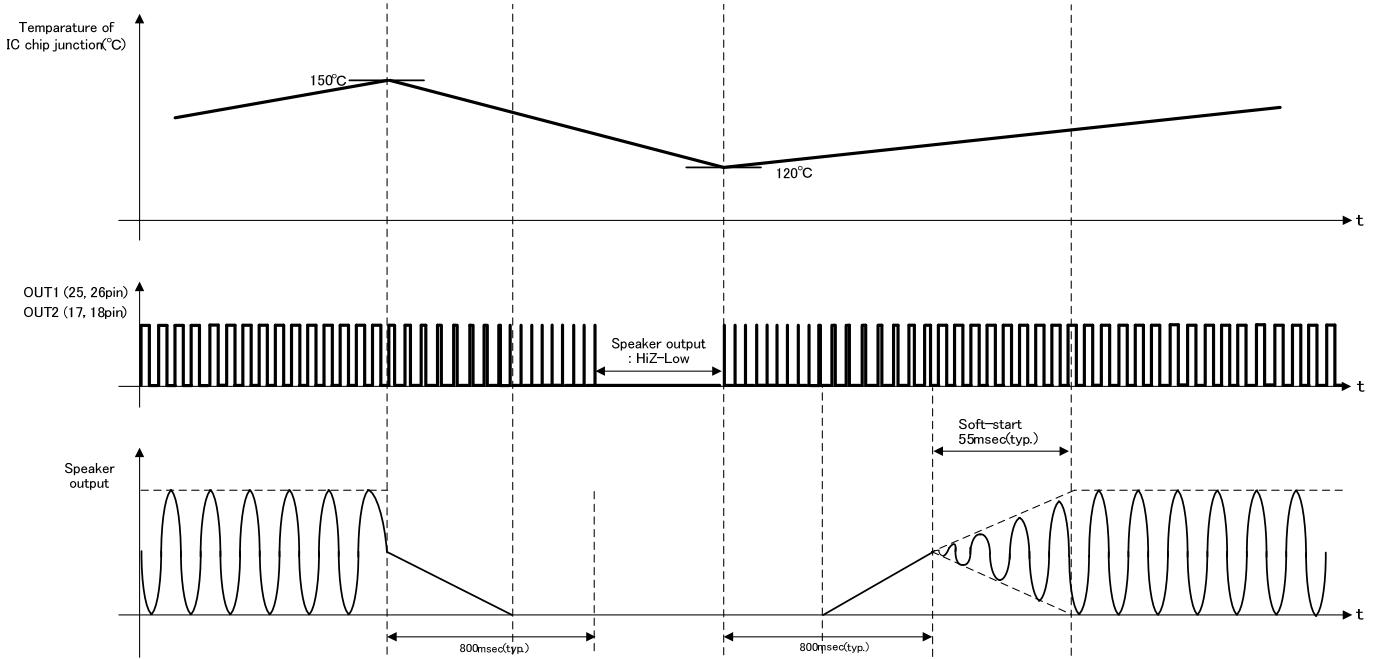

4) Under voltage protection

This IC has the under voltage protection circuit that make speaker output mute once detecting extreme drop of the power supply voltage.

Detecting condition – It will detect when PDX pin is set High and the power supply voltage becomes lower than 8V.

The speaker output is muted when detected.

Releasing condition – It will release when PDX pin is set High and the power supply voltage becomes more than 9V.

The speaker output is outputted through a soft-start when released.

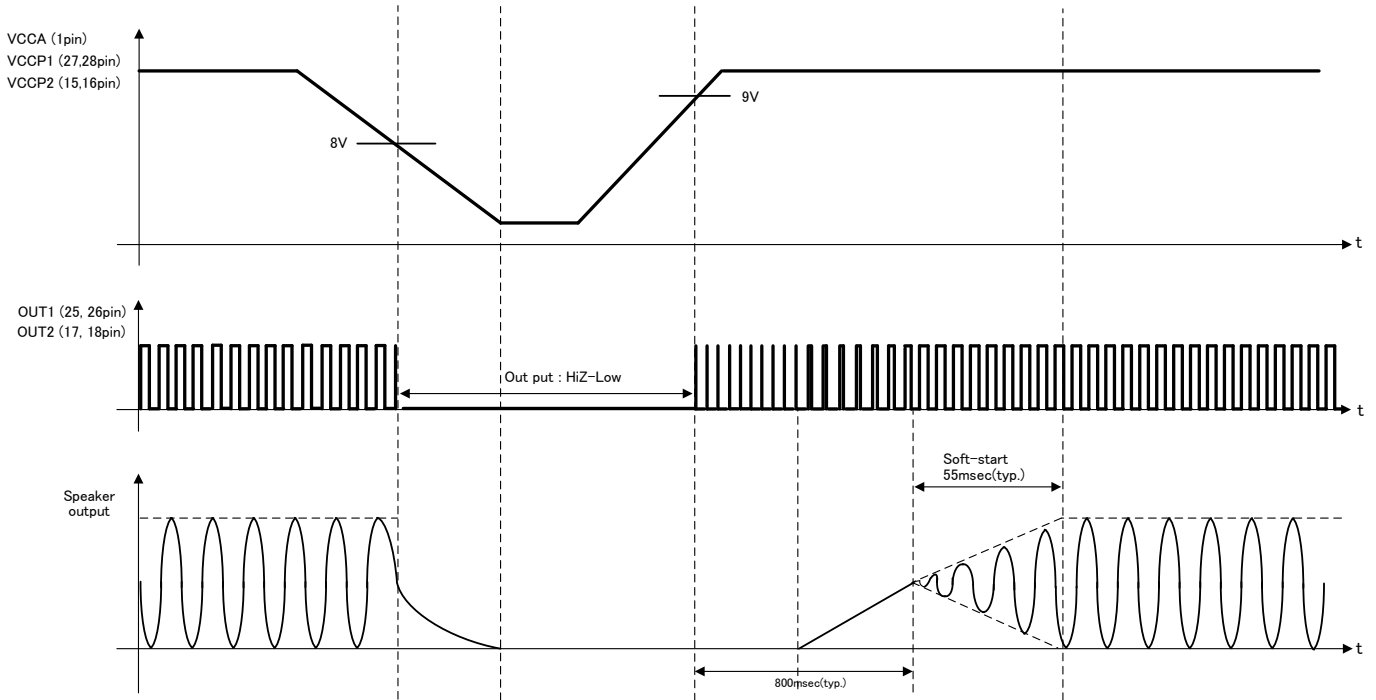

● Application Circuit Example (single-ended output × 2)

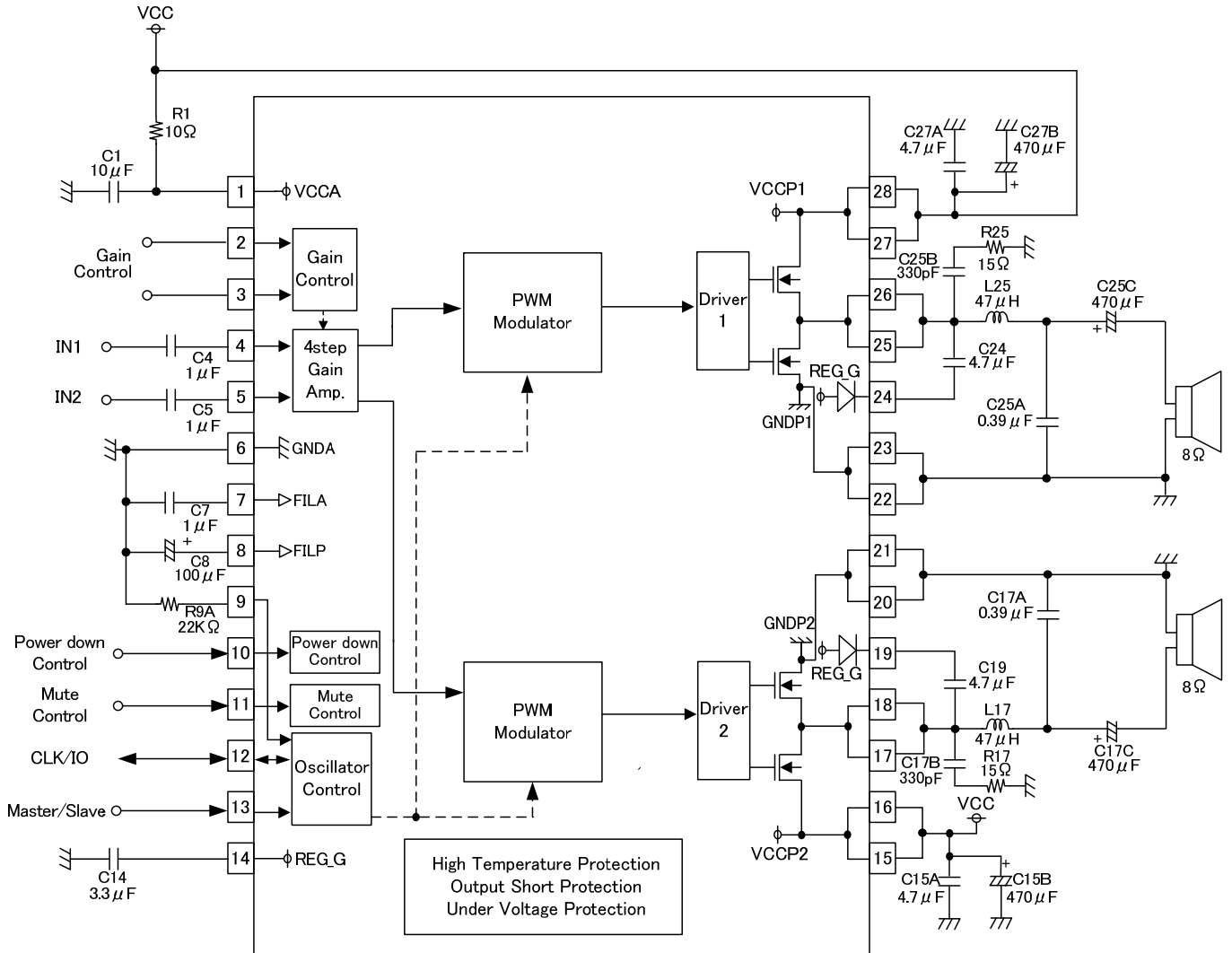

●BOM List (single-ended output × 2)

Parts	Parts No.	Value	Company	Product No.	Rated Voltage	Tolerance	Size
IC	U1	—	ROHM	BD5444EFV	—	—	9.7mm×6.4mm
Inductor	L17, L25	47μH	TOKO	A7503AY-470M	—	±20%	φ11mm×13.5mm
Resistor	R1	10Ω	ROHM	MCR18EZHFL10R0	1/4W	F(±1%)	3.2mm×1.6mm
	R9A	22kΩ		MCR01M2PF2202	1/16W	F(±1%)	1.0mm×0.5mm
	R17,R25	15Ω		MCR18EZHFL15R0	1/4W	F(±1%)	3.2mm×1.6mm
Capacitor	C1	10μF	MURATA	GRM32DF51H106ZA01	50V	Y5V (+80% / -20%)	3.2mm×2.5mm
	C19, C24	4.7uF		GRM21BB31C475KA87	16V	B(±10%)	2.0mm×1.2mm
	C15A, C27A	4.7uF		GRM31CF11H475ZA01	50V	F (+80% / -20%)	3.2mm×1.6mm
	C17A, C25A	0.39uF		GRM32MB11H394KA01	50V	B(±10%)	3.2mm×2.5mm
	C14	3.3μF		GRM188B31A335KE15	10V	B(±10%)	1.6mm×0.8mm
	C4, C5, C7	1μF		GRM185B30J105KE25	6.3V	B(±10%)	1.6mm×0.8mm
	C17B, C25B	330pF		GRM188B11H331KA01	50V	B(±10%)	1.6mm×0.8mm
Electrolytic Capacitor	C15B, C17C, C25C, C27B	470μF	Rubycon	35ZLH470M	35V	±20%	φ10mm×16mm
	C8	100uF		16ZLH100M	16V	±20%	φ5mm×11mm

(*1) Please change the following parts, when using RL=6Ω speaker.

Inductor	L17, L25	33μH	TOKO	A7503AY-330M	—	±20%	φ11mm×13.5mm
Resistor	R17,R25	10Ω	ROHM	MCR18EZHFL10R0	1/4W	F(±1%)	3.2mm×1.6mm
Capacitor	C17A, C25A	0.47μF	MURATA	GRM32MB11H474KA01	50V	B(±10%)	3.2mm×2.5mm
	C17B, C25B	680pF		GRM188B11H681KA01	50V	B(±10%)	1.6mm×0.8mm
	C17C, C25C	680μF	Rubycon	35ZLH680M	35V	±20%	φ10mm×23mm

(*2) Please change the following parts, when using RL=4Ω speaker.

Inductor	L17, L25	22μH	TOKO	A7503AY-220M	-	±20%	φ11mm×13.5mm
Resistor	R17,R25	5.6Ω	ROHM	MCR18EZHFL5R60	1/4W	F(±1%)	3.2mm×1.6mm
Capacitor	C17A, C25A	0.68μF	MURATA	GRM32NB11H684KA01	50V	B(±10%)	3.2mm×2.5mm
	C17B, C25B	1000pF		GRM188B11H102KA01	50V	B(±10%)	1.6mm×0.8mm
	C17C, C25C	1000μF	Rubycon	35ZLH1000M	35V	±20%	φ12.5mm×20mm

● Application Circuit Example (BTL output)

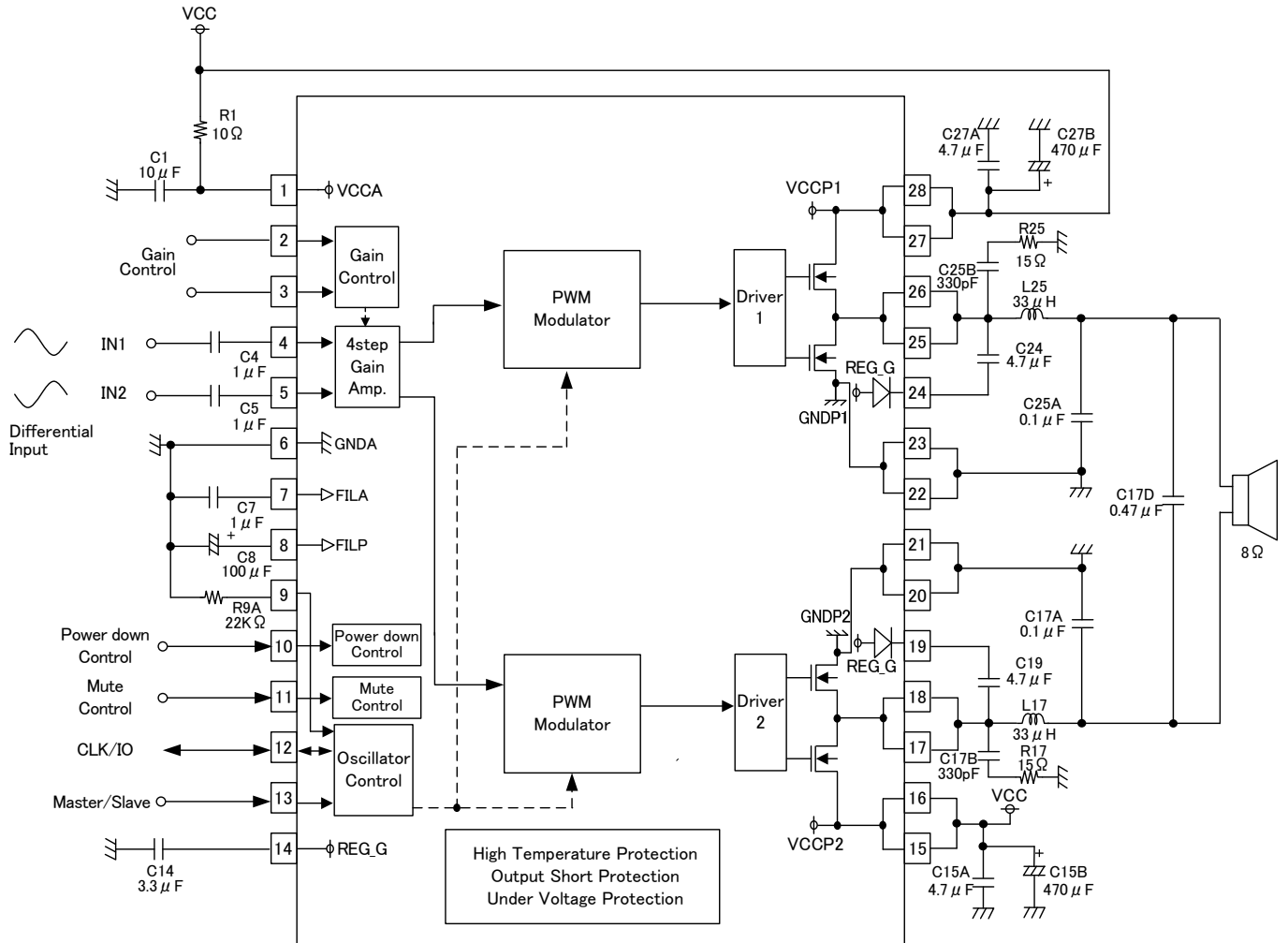

●BOM List (BTL output)

Parts	Parts No.	Value	Company	Product No.	Rated Voltage	Tolerance	Size
IC	U1	—	ROHM	BD5444EFV	—	—	9.7mm×6.4mm
Inductor	L17, L25	33μH	TOKO	A7503AY-330M	—	±20%	φ11mm×13.5mm
Resistor	R1	10Ω	ROHM	MCR18EZH10R0	1/4W	F(±1%)	3.2mm×1.6mm
	R9A	22kΩ		MCR01MZPF2202	1/16W	F(±1%)	1.0mm×0.5mm
	R17,R25	15Ω		MCR18EZH15R0	1/4W	F(±1%)	3.2mm×1.6mm
Capacitor	C1	10μF	MURATA	GRM32DF51H106ZA01	50V	Y5V (+80% / -20%)	3.2mm×2.5mm
	C19, C24	4.7uF		GRM21BB31C475KA87	16V	B(±10%)	2.0mm×1.2mm
	C15A, C27A	4.7uF		GRM31CF11H475ZA01	50V	F(+80% / -20%)	3.2mm×1.6mm
	C17A, C25A	0.1uF		GRM188B31H104KA92	50V	B(±10%)	1.6mm×0.8mm
	C17D	0.47uF		GRM32MB11H474LA01	50V	B(±20%)	3.2mm×2.5mm
	C14	3.3μF		GRM188B31A335KE15	10V	B(±10%)	1.6mm×0.8mm
	C4, C5, C7	1μF		GRM185B30J105KE25	6.3V	B(±10%)	1.6mm×0.8mm
	C17B, C25B	330pF		GRM188B11H331KA01	50V	B(±10%)	1.6mm×0.8mm
Electrolytic Capacitor	C15B, C27B	470μF	Rubycon	35ZLH470M	35V	±20%	φ10mm×16mm
	C8	100uF		16ZLH100M	16V	±20%	φ5mm×11mm

(※1) Please change the following parts, when using RL=6Ω speaker.

Inductor	L17, L25	22μH	TOKO	A7503AY-220M	—	±20%	φ11mm×13.5mm
Resistor	R17,R25	10Ω	ROHM	MCR18EZH10R0	1/4W	F(±1%)	3.2mm×1.6mm
Capacitor	C17A, C25A	0.15μF	MURATA	GRM21BB31H154MA88	50V	B(±20%)	2.0mm×1.2mm
	C17B, C25B	680pF		GRM188B11H681KA01	50V	B(±10%)	1.6mm×0.8mm
	C17D	0.68μF		GRM32NB11H684MA01	50V	B(±20%)	3.2mm×2.5mm

(※2) Please change the following parts, when using RL=4Ω speaker.

Inductor	L17, L25	15μH	TOKO	A7503AY-150M	—	±20%	φ11mm×13.5mm
Resistor	R17,R25	5.6Ω	ROHM	MCR18EZH15R60	1/4W	F(±1%)	3.2mm×1.6mm
Capacitor	C17A, C25A	0.22μF	MURATA	GRM21BB31H224MA88	50V	B(±20%)	2.0mm×1.2mm
	C17B, C25B	1000pF		GRM188B11H102KA01	50V	B(±10%)	1.6mm×0.8mm
	C17D	1μF		GRM31MB31H105KA87	50V	B(±20%)	3.2mm×2.5mm

● Application Circuit Example (2.1ch output)

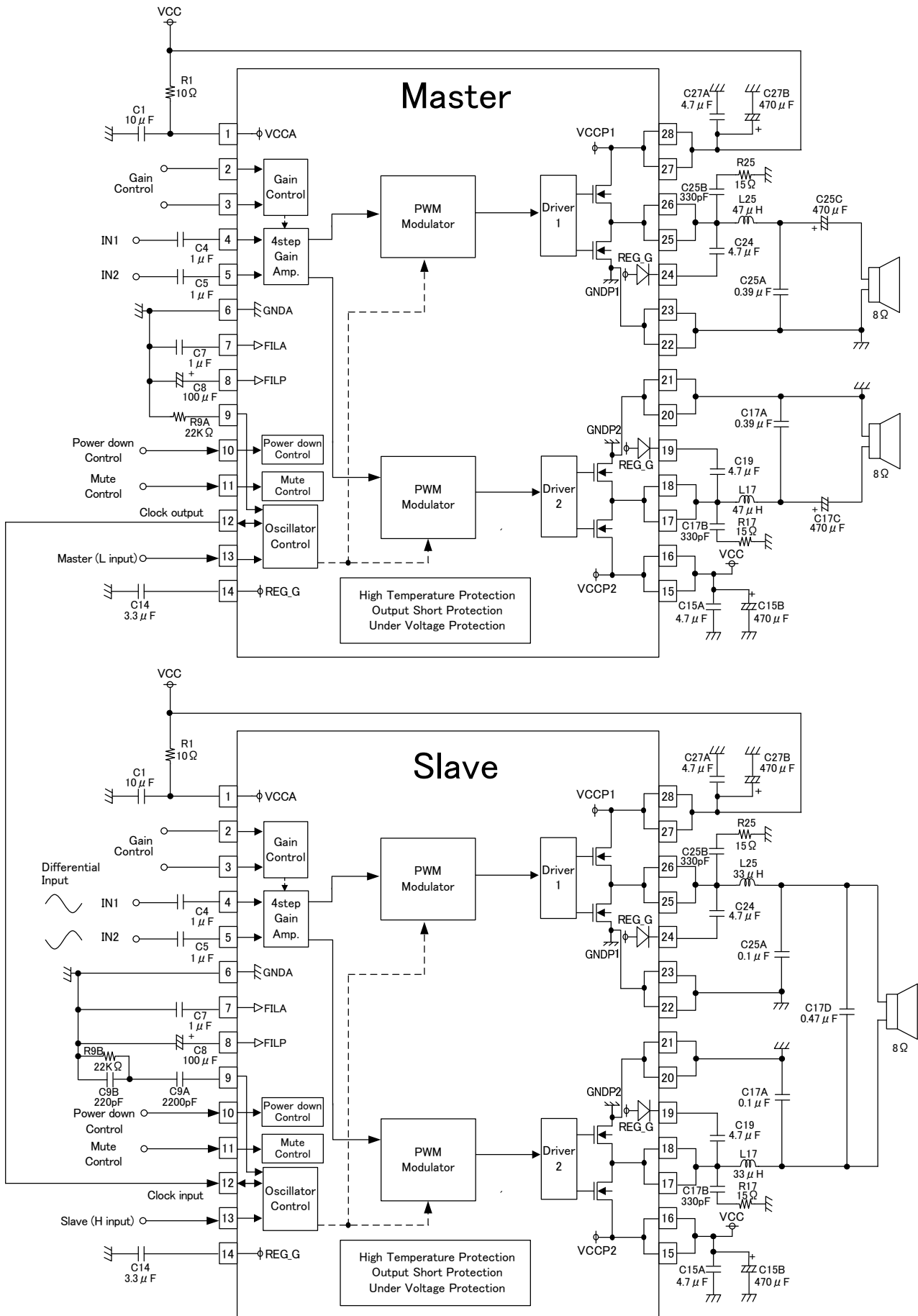

●BOM List (2.1ch output)

Parts	Parts No.	Value	Company	Product No.	Rated Voltage	Tolerance	Size
Resistor	R9B	22kΩ	ROHM	MCR01MZPF2202	1/16W	F(±1%)	1.0mm×0.5mm
Capacitor	C9A	2200pF	MURATA	GRM155R61A222KA01	10V	X5R(±10%)	1.0mm × 0.5mm
	C9B	220pF		GRM1552C1E221JA01	25V	CH(±5%)	1.0mm × 0.5mm

(※) Parts are written used at "Slave mode" only. Please use same parts written P23 ~ P26.

●Notes for use

1) Absolute maximum ratings

Use of the IC in excess of absolute maximum ratings such as the applied voltage or operating temperature range may result in IC damage. Assumptions should not be made regarding the state of the IC (short mode or open mode) when such damage is suffered. A physical safety measure such as a fuse should be implemented when use of the IC in a special mode where the absolute maximum ratings may be exceeded is anticipated.

2) Power supply lines

As return of current regenerated by back EMF of output coil happens, take steps such as putting capacitor between power supply and Gnd as a electric pathway for the regenerated current. Be sure that there is no problem with each property such as emptied capacity at lower temperature regarding electrolytic capacitor to decide capacity value. If the connected power supply does not have sufficient current absorption capacity, regenerative current will cause the voltage on the power supply line to rise, which combined with the product and its peripheral circuitry may exceed the absolute maximum ratings. It is recommended to implement a physical safety measure such as the insertion of a voltage clamp diode between the power supply and Gnd pins.

3) Gnd potential (Pin 6, 20, 21, 22, 23)

Ensure a minimum Gnd pin potential in all operating conditions.

4) Input terminal

The parasitic elements are formed in the LSI because of the voltage relation. The parasitic element operating causes the wrong operation and destruction. Therefore, please be careful so as not to operate the parasitic elements by impressing to input terminals lower voltage than Gnd. Please do not apply the voltage to the input terminal when the power-supply voltage is not impressed.

5) Setting of heat

Use a thermal design that allows for a sufficient margin in light of the power dissipation (Pd) in actual operating conditions. This IC exposes its frame of the backside of package. Note that this part is assumed to use after providing heat dissipation treatment to improve heat dissipation efficiency. Try to occupy as wide as possible with heat dissipation pattern not only on the board surface but also the backside.

Class D power amplifier is High efficiency and low heat generation by comparison with conventional Analog power amplifier. However, In case it is operated continuously by maximum output power, Power dissipation(Pdiss) may exceed package dissipation. Please consider about heat design that Power dissipation(Pdiss) does not exceed Package dissipation(Pd) in average power(Poav). (Tjmax :Maximum junction temperature=150°C, Ta :Peripheral temperature[°C], θja : Thermal resistance of package[°C/W], Poav: Average power[W], η: Efficiency)

$$\text{Package dissipation: } Pd \text{ (W)} = (T_{jmax} - T_a) / \theta_{ja}$$

$$\text{Power dissipation: } Pdiss \text{ (W)} = Poav * (1 / \eta - 1)$$

6) Actions in strong magnetic field

Use caution when using the IC in the presence of a strong magnetic field as doing so may cause the IC to malfunction.

7) Thermal shutdown circuit

This product is provided with a built-in thermal shutdown circuit. When the thermal shutdown circuit operates, the output transistors are placed under open status. The thermal shutdown circuit is primarily intended to shut down the IC avoiding thermal runaway under abnormal conditions with a chip temperature exceeding Tjmax = 150°C.

8) Shorts between pins and misinstallation

When mounting the LSI on a board, pay adequate attention to orientation and placement discrepancies of the LSI. If it is misinstalled and the power is turned on, the LSI may be damaged. It also may be damaged if it is shorted by a foreign substance coming between pins of the LSI or between a pin and a power supply or a pin and a Gnd

9) Power supply on/off (Pin 1, 15, 16, 27, 28)

In case power supply is started up, PDX (Pin 10) and MUTEX (Pin 11) always should be set LOW, And in case power supply is shut down, it should be set LOW likewise. Then it is possible to eliminate pop noise when power supply is turned on/off. And also, all power supply terminals should start up and shut down together.

10) Precautions for Speaker-setting

If the impedance characteristics of the speakers at high-frequency range while increase rapidly, the IC might not have stable-operation in the resonance frequency range of the LC-filter. Therefore, consider adding damping-circuit, etc., depending on the impedance of the speaker.

● Allowable Power Dissipation

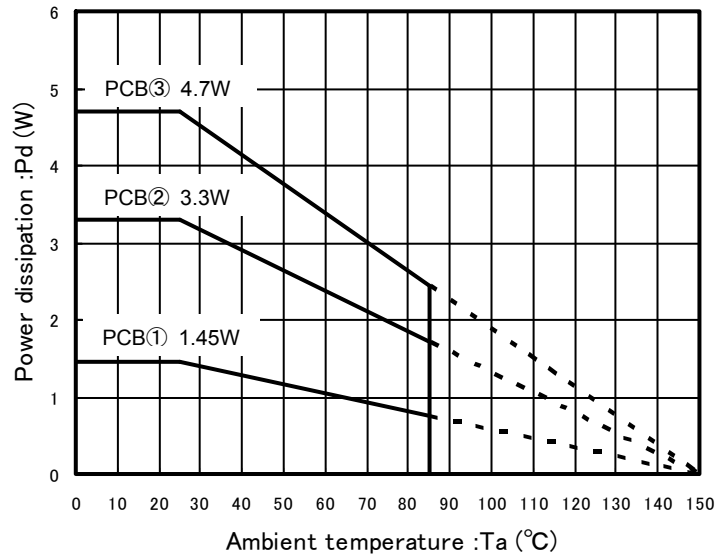

Measuring instrument : TH-156 (Kuwano Electrical Instruments Co., Ltd.)

Measuring conditions : Installation on ROHM's board

Board size : 70mm×70mm×1.6mm (with thermal via on board)

Material : FR4

- The board on exposed heat sink on the back of package are connected by soldering.

PCB① : 1-layer board (back copper foil size: 0mm×0mm), $\theta_{ja}=86.2^{\circ}\text{C}/\text{W}$

PCB② : 2-layer board (back copper foil size: 70mm×70mm), $\theta_{ja}=37.8^{\circ}\text{C}/\text{W}$

PCB③ : 4-layer board (back copper foil size: 70mm×70mm), $\theta_{ja}=26.6^{\circ}\text{C}/\text{W}$

● Ordering part number

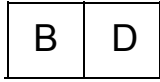

Part No.

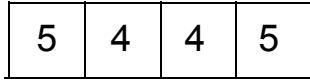

Part No.



Package
EFV:HTSSOP-B28

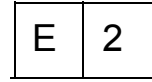

Packaging and forming specification
E2: Embossed tape and reel

HTSSOP-B28

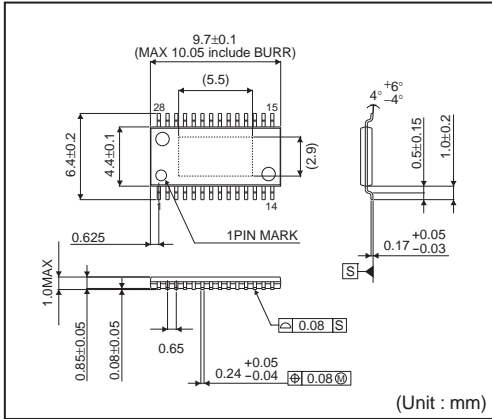

<Tape and Reel information>

Tape	Embossed carrier tape (with dry pack)
Quantity	2500pcs
Direction of feed	E2 (The direction is the 1pin of product is at the upper left when you hold reel on the left hand and you pull out the tape on the right hand)

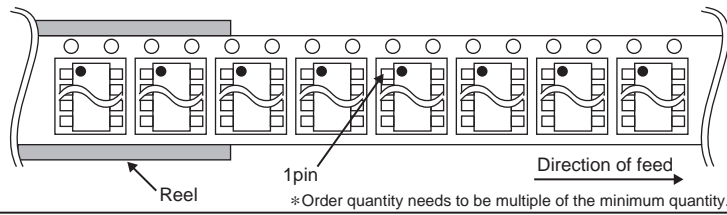

Notes

No copying or reproduction of this document, in part or in whole, is permitted without the consent of ROHM Co.,Ltd.

The content specified herein is subject to change for improvement without notice.

The content specified herein is for the purpose of introducing ROHM's products (hereinafter "Products"). If you wish to use any such Product, please be sure to refer to the specifications, which can be obtained from ROHM upon request.

Examples of application circuits, circuit constants and any other information contained herein illustrate the standard usage and operations of the Products. The peripheral conditions must be taken into account when designing circuits for mass production.

Great care was taken in ensuring the accuracy of the information specified in this document. However, should you incur any damage arising from any inaccuracy or misprint of such information, ROHM shall bear no responsibility for such damage.

The technical information specified herein is intended only to show the typical functions of and examples of application circuits for the Products. ROHM does not grant you, explicitly or implicitly, any license to use or exercise intellectual property or other rights held by ROHM and other parties. ROHM shall bear no responsibility whatsoever for any dispute arising from the use of such technical information.

The Products specified in this document are intended to be used with general-use electronic equipment or devices (such as audio visual equipment, office-automation equipment, communication devices, electronic appliances and amusement devices).

The Products specified in this document are not designed to be radiation tolerant.

While ROHM always makes efforts to enhance the quality and reliability of its Products, a Product may fail or malfunction for a variety of reasons.

Please be sure to implement in your equipment using the Products safety measures to guard against the possibility of physical injury, fire or any other damage caused in the event of the failure of any Product, such as derating, redundancy, fire control and fail-safe designs. ROHM shall bear no responsibility whatsoever for your use of any Product outside of the prescribed scope or not in accordance with the instruction manual.

The Products are not designed or manufactured to be used with any equipment, device or system which requires an extremely high level of reliability the failure or malfunction of which may result in a direct threat to human life or create a risk of human injury (such as a medical instrument, transportation equipment, aerospace machinery, nuclear-reactor controller, fuel-controller or other safety device). ROHM shall bear no responsibility in any way for use of any of the Products for the above special purposes. If a Product is intended to be used for any such special purpose, please contact a ROHM sales representative before purchasing.

If you intend to export or ship overseas any Product or technology specified herein that may be controlled under the Foreign Exchange and the Foreign Trade Law, you will be required to obtain a license or permit under the Law.



Thank you for your accessing to ROHM product informations.
More detail product informations and catalogs are available, please contact us.

ROHM Customer Support System

<http://www.rohm.com/contact/>