



*Z86C36*

*ICEBOX*

**User Manual**

UM002202-1001

**Z86C36  
ICEBOX**



This publication is subject to replacement by a later edition. To determine whether a later edition exists, or to request copies of publications, contact:

**ZiLOG Worldwide Headquarters**

910 E. Hamilton Avenue

Campbell, CA 95008

Telephone: 408.558.8500

Fax: 408.558.8300

[www.ZiLOG.com](http://www.ZiLOG.com)

**Document Disclaimer**

ZiLOG is a registered trademark of ZiLOG Inc. in the United States and in other countries. All other products and/or service names mentioned herein may be trademarks of the companies with which they are associated.

©2001 by ZiLOG, Inc. All rights reserved. Information in this publication concerning the devices, applications, or technology described is intended to suggest possible uses and may be superseded. ZiLOG, INC. DOES NOT ASSUME LIABILITY FOR OR PROVIDE A REPRESENTATION OF ACCURACY OF THE INFORMATION, DEVICES, OR TECHNOLOGY DESCRIBED IN THIS DOCUMENT. ZiLOG ALSO DOES NOT ASSUME LIABILITY FOR INTELLECTUAL PROPERTY INFRINGEMENT RELATED IN ANY MANNER TO USE OF INFORMATION, DEVICES, OR TECHNOLOGY DESCRIBED HEREIN OR OTHERWISE. Except with the express written approval of ZiLOG, use of information, devices, or technology as critical components of life support systems is not authorized. No licenses are conveyed, implicitly or otherwise, by this document under any intellectual property rights.



# *Table of Contents*

- Table of Contents** ..... **iii**
- List of Figures** ..... **v**
- List of Tables** ..... **vii**
- Preface** ..... **ix**
- Introduction** ..... **1**
  - Overview ..... 1
  - ICEBOX Features ..... 1
    - Supported ZiLOG Devices ..... 2
  - Hardware Specifications ..... 4
    - Operating Conditions ..... 4
    - Power Requirements ..... 4
    - Serial Interface ..... 4
  - GUI-Supported Compiler, Assembler Formats ..... 4
  - Kit Contents ..... 5
    - Additional Items Not Supplied ..... 5
    - Optional Recommended Item ..... 6
  - Computer Requirements ..... 6
    - Minimum Requirements ..... 6
  - Contacting ZiLOG Customer Support ..... 7
- Setup and Installation** ..... **9**
  - Hardware Installation ..... 9
    - Quick Installation Instructions ..... 9
    - Complete Installation Instructions ..... 12
    - Set Power Jumper ..... 12
    - Installing a New ICE Chip ..... 16
  - Software Installation ..... 18
  - ICEBOX Operation ..... 18
    - Resetting ..... 19



LED Operation .....	19
Jumper Settings .....	20
<b>Overview .....</b>	<b>23</b>
Using ZDS .....	23
Select the ICEBOX .....	23
Open a Project and Add Files .....	26
Available Debug Windows .....	29
<b>Appendix A: Troubleshooting Guide .....</b>	<b>31</b>
Introduction .....	31
Error Opening Serial Port .....	31
Counter Jumps to Unexpected Address .....	32
ZDS Error Messages .....	32
Can Not Open Windows .....	32
Out of Synchronization with the Emulator .....	33
<b>Appendix B: ASCII Character Set .....</b>	<b>35</b>
<b>Appendix C: Problem/Suggestion Report Form .....</b>	<b>41</b>
<b>Glossary .....</b>	<b>43</b>
<b>Index .....</b>	<b>47</b>



## *List of Figures*

Figure 1.	Hook-Up Diagram . . . . .	10
Figure 2.	Z86C36 ICEBOX External Top View . . . . .	11
Figure 3.	J1 Jumper Schematic . . . . .	13
Figure 4.	ICE Chip Installation . . . . .	17
Figure 5.	Closing the ICE Chip Locking Lever . . . . .	18
Figure 6.	New Project Dialog Box . . . . .	24
Figure 7.	Emulator Configuration Dialog Box . . . . .	25
Figure 8.	Project Viewer Window . . . . .	27
Figure 9.	Insert Files into Project Dialog Box . . . . .	27
Figure 10.	Project Viewer Window with File . . . . .	28

Z86C36  
ICEBOX



vi

This page intentionally left blank.



## *List of Tables*

Table 1.	Z86C5020GSE ICE Chip Supported Products (Z86C3500ZEM Target Emulator Selection) . . . . .	2
Table 2.	Z86C5120GSE ICE Chip Supported Products (Z86C3600ZEM Target Emulator Selection) . . . . .	2
Table 3.	Front LED Assignments . . . . .	19
Table 4.	Jumper Settings . . . . .	29
Table 5.	ASCII Character Set . . . . .	35



This page intentionally left blank.



# *Preface*

We recommend that you read and understand everything in this manual before setting up and using the product. However, we recognize that users have different styles of learning. Therefore, we have designed this manual to be used either as a how-to procedural manual or a reference guide to important data.

The following conventions have been adopted to provide clarity and ease of use:

- Times 10-point all-caps is used to highlight the following items:
  - commands, displayed messages
  - menu selections, pop-up lists, button, fields, or dialog boxes
  - modes
  - pins and ports
  - program or application name
  - instructions, registers, signals and subroutines
  - an action performed by the software
  - icons
- Courier Regular 10-point is used to highlight the following items
  - bit
  - software code
  - file names and paths
  - hexadecimal value



- Grouping of Actions Within a Procedure Step

Actions in a procedure step are all performed on the same window or dialog box. Actions performed on different windows or dialog boxes appear in separate steps.

## Electrical

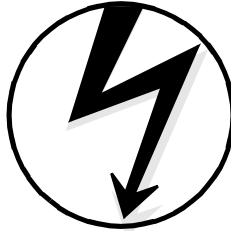

## Safeguards

Follow the precautions listed below to avoid permanent damage to the emulator.

1. Always use a grounding strap to prevent damage resulting from electrostatic discharge (ESD).
2. Power-Up Precautions.
  - a. Ensure that all power to the emulator and the target application (if any) is turned OFF.
  - b. Connect the target pod to the target application (if any).
  - c. Power up the emulator, then press the RESET button.
  - d. Power up the target application (if any).
3. Power-Down Precautions.

When powering down, follow this procedure in the precise order shown below:

- a. Halt emulation.
- b. In ZDS select Reset from the Build or Debug Menu.
- c. Power down the target application board (if any).
- d. Remove the target pod.
- e. Power down the emulator.



► **Notes:**

1. Refer to the “Precaution List” section of the Product Information sheet for additional operating precautions specific to various devices.
2. Do not leave the emulator powered up with the RS-232C cable connected to a powered-down PC.
3. Before inserting target pod into target application board, refer to Chapter 2 to determine appropriate jumper selections and options.

# *1 Introduction*

## OVERVIEW

Congratulations for selecting a fine development tool! The Z86C36 ICEBOX provides in-circuit emulation for the Z8 family of UART controllers. The ICEBOX consists of an emulation daughter board that is plugged into a 32-MHz motherboard using P1 and P2 headers. The Z86C50 ICE chip is used as the emulation processor for devices with less than or equal to 32K of code memory. The Z86C51 ICE chip is used as the emulation processor for devices with 64K of code memory, that is, Z86C36 and Z86C46.

The 32 MHz motherboard has been modified for 64 K operation and provides host communication interface, control processor, I/O space decoding, and LED indicator. The ICEBOXes are designed to be used with ZiLOG Developers Studio, giving the user a total package to write, edit, and debug their applications.

## ICEBOX FEATURES

Key features of the Z86C36 ICEBOX include:

- Supports up to 64 K of ROM
- The capability to vary the operating voltage from 3.0–5.0 V
- Supports in-circuit emulation on target systems that operate from 3.0–5.5 V
- The user can choose to power the Ice chip from either the ICEBOX or target board
- Supports UART devices that operate up to 16.384 MHz



- Emulates and supports all the features and functions for a specified Z8 UART microcontroller
- Multitasking allows the user to use other Windows applications while ZiLOG Developer Studio (ZDS) is running

## Supported ZiLOG Devices

Table 1 shows products supported by the Z86C5020GSE ICE chip.  
Table 2 shows the products supported by the Z86C5120GSE ICE chip.

**Table 1. Z86C5020GSE ICE Chip Supported Products (Z86C3500ZEM Target Emulator Selection)**

Packages	Emulation	OTP	Required Accessories
28 PDIP	Z86C34–C35	N/A	28 PDIP emulation pod
28 SOIC	Z86C34–C35	N/A	28 PDIP emulation pod and a DIP to SOIC conversion adapter from Emulation Technology (AS-DIP-6-028-S003-1 or AS-DIP-6-028-S003-2)
28 PLCC	Z86C34–C35	N/A	28 PLCC emulation pod
40 PDIP	Z86C44–C45	N/A	40 PDIP emulation pod
44 PLCC	Z86C44–C45	N/A	44 PLCC emulation pod
44 QFP	N/A	N/A	N/A

**Table 2. Z86C5120GSE ICE Chip Supported Products (Z86C3600ZEM Target Emulator Selection)**

Packages	Emulation	OTP	Required Accessories
28 PDIP	Z86C36	N/A	28 PDIP emulation pod



**Table 2. Z86C5120GSE ICE Chip Supported Products (Z86C3600ZEM Target Emulator Selection) (Continued)**

<b>Packages</b>	<b>Emulation</b>	<b>OTP</b>	<b>Required Accessories</b>
28 SOIC	Z86C36	N/A	28 PDIP emulation pod and a DIP to SOIC conversion adapter from Emulation Technology (AS-DIP-6-028-S003-1 or AS-DIP-6-028-S003-2)
28 PLCC	Z86C36	N/A	28 PLCC emulation pod
40 PDIP	Z86C46	N/A	40 PDIP emulation pod
44 PLCC	Z86C46	N/A	44 PLCC emulation pod

- **Notes:** The Z86C3600ZEM becomes the Z86C3500ZEM when you use a Z86C50 ICE chip.



## HARDWARE SPECIFICATIONS

### Operating Conditions

Operating Humidity:	10%-90% RH (Noncondensing)
Operating Temperature:	20 °C ±10 °C
Clocks:	The control processor operates at 7.3728 Mhz; the emulation processor operates at 16.384 Mhz
Serial Baud Rate:	57,600 bps

### Power Requirements

This ICEBOX requires an external 5VDC power supply.

Operating Voltage (Input):	+4.75 VDC to +5.25 VDC Max (+5.0 VDC typical)
Operating Voltage (Target):	+3.0 VDC to +5.5 VDC Max
Operating Current:	2.5 A typical (maximum 3.0 A)

### Serial Interface

ZiLOG Developer Studio communicates with the Z86C36 ICEBOX using a DB25, RS-232 and DCE cable (TxD, RxD only).

## GUI-SUPPORTED COMPILER, ASSEMBLER FORMATS

The ICEBOX supports object (binary or Intel hex) code files produced by ZiLOG Developer Studio (ZDS) and ZiLOG Macro Cross Assembler (ZMASM).





## KIT CONTENTS

The ICEBOX kit contains one of each of the following items:

- Z86C36 ICEBOX
- 40 PDIP emulation pod with cable ZiLOG: 93C0024-001
- 44 PLCC emulation pod ZiLOG PC: 99C0273-001
- 28 PDIP emulation pod ZiLOG PC: 99C0742-001
- 28 PLCC emulation pod ZiLOG PC: 99C0512-001
- Power Cable with Banana Plugs
- RS-232 Serial Cable, DB 25
- ZiLOG Developer Studio Installation CD
- Z86C36 ICEBOX User Manual
- ZiLOG Developer Studio manual contained on the ZDS installation CD-ROM.

► **Note:** If the ZDS CD-ROM does not contain the manual, it can be downloaded from the ZiLOG web page at [www.zilog.com](http://www.zilog.com).

## Additional Items Not Supplied

The following item is required but are not currently supplied in the ICEBOX kit:

- A source of power (+5 VDC typical) for the ICEBOX. This can be a laboratory power supply with current rating of at least 2.5 ampere.



## Optional Recommended Item

The following items are recommended:

- Your target design. The target design is a wire-wrapped or printed circuit prototype that includes a socket for the target device that the ICEBOX cable/pod plugs into.
- C-Compiler

► **Note:** Contact a ZiLOG Sales Office or Distributor to order a copy of the Z8 C-Compiler. Refer to our website for a representative near you: <http://www.zilog.com/sales/>.

- Oscilloscope
- Logic Analyzer

## COMPUTER REQUIREMENTS

### Minimum Requirements

- IBM PC (or 100-percent compatible) Pentium based machine
- 75 MHz or more with 16 MB RAM
- VGA Video Adapter
- Hard Disk Drive (12 MB free space)
- CD-ROM Drive (a CD-ROM drive is not needed if you download ZDS from the web at [www.zilog.com](http://www.zilog.com))
- RS-232 COM Port
- Mouse or Pointing Device
- Microsoft Windows 95/98/NT

The following enhancements to the minimum requirements are recommended:

- 166-MHz IBM PC
- SVGA video adapter
- Printer

## **CONTACTING ZILOG CUSTOMER SUPPORT**

ZILOG has a worldwide customer support center located in Austin, Texas. The customer support center is open from 7 a.m. to 7 p.m. Central Time.

The customer support toll-free number for the United States and Canada is 1-877-ZiLOGCS (1-877-945-6427). For calls outside of the United States and Canada dial 512-306-4067. The FAX number to the customer support center is 512-306-4072. Customers can also contact the support center through our website at <http://www.zilog.com/support/>.

For valuable information about hardware and software development tools, go to ZiLOG home page at <http://www.zilog.com>. The latest released version of the ZDS can be downloaded from this site.



This page intentionally left blank.

## *2 Setup and Installation*

### **HARDWARE INSTALLATION**

Before installing the hardware, refer to Figure 1 for a diagram on connecting the ICEBOX to a PC and power supply. Figure 2 provides option jumper locations.

#### **Quick Installation Instructions**

To install the hardware using a bench power supply, perform the following.

1. Set the correct jumper setting for powering the ICE chip and target board. See Set Power Jumper on page 12.
2. Connect the power supply to the emulator and ensure it is set to provide + 5.0 V and 2.5 A.
3. Connect the serial cable to the PC.
4. Connect the ICEBOX to the target board (if performing in-circuit emulation).
5. Set up the oscillator and option jumpers.
6. Select the ICE chip that you want to emulate.
7. Power up the ICEBOX.



**Figure 1. Hook-Up Diagram**

- ▶ **Note:** Each ICEBOX is shipped with a 16.384 MHz oscillator. The user can also use the target's oscillator or a crystal/ ceramic resonator to clock the ICE chip, for more information see Jumper Settings on page 20.

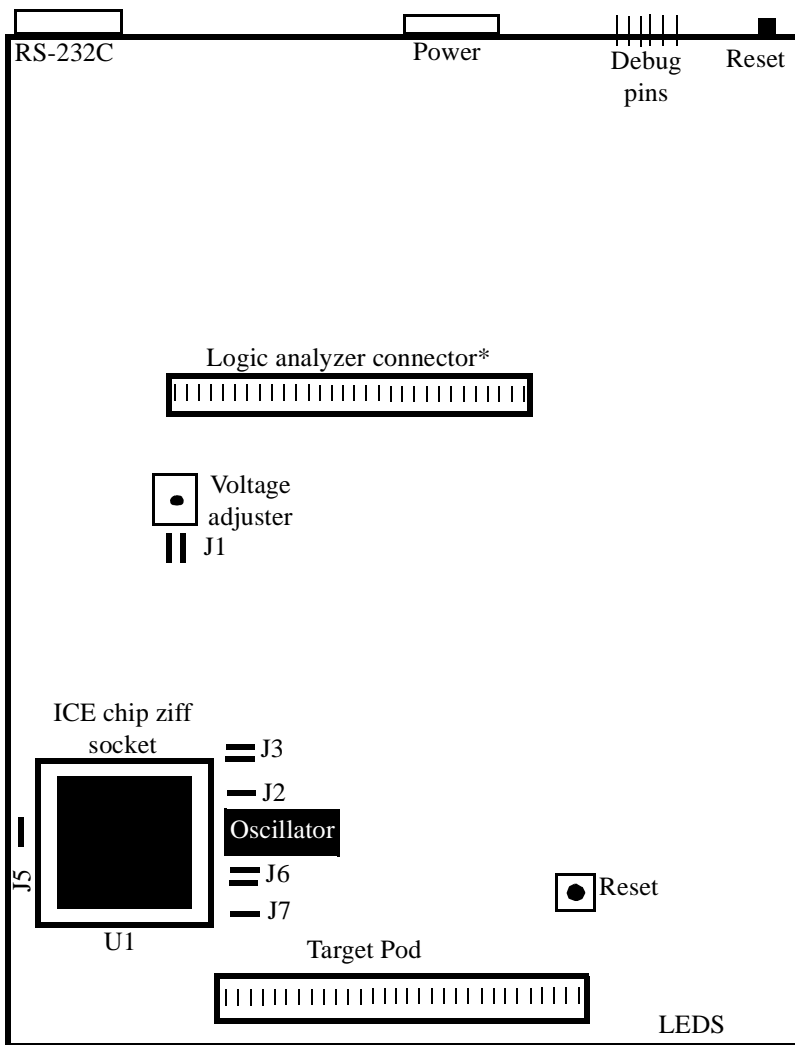

\*This is not supported.

Figure 2. Z86C36 ICEBOX External Top View



## Complete Installation Instructions

The following procedures illustrate a complete step-by-step guide on installing the ICEBOX.

### Set Power Jumper

The Z86C36 ICEBOXes allow the user to power the ICEBOXes and target from a variety of different sources. Before powering the ICEBOX the user should select the power configuration.



**Caution:** The procedures below must be followed exactly as described. Before beginning the procedures study Figure 3, which shows a schematic of the J1 power jumper. Failure to follow the procedures will result in total damage to the ICEBOX or target.

Choose from one of the following options when selecting the power source:

- Jumper pin 1 to pin 2 to power the ICE chip with the ICEBOX's adjustable regulator
- Jumper pin 3 to pin 4 to power target with the ICEBOX's adjustable regulator
- Jumper pin 1 to pin 2 and pin 3 to pin 4 to power both the ICE chip and target from the ICEBOX's adjustable regulator
- Jumper pin 2 to pin 4 to power the ICE chip from the target



**Note:** When powering the target from the ICEBOX ensure that the target's power supply is disconnected.



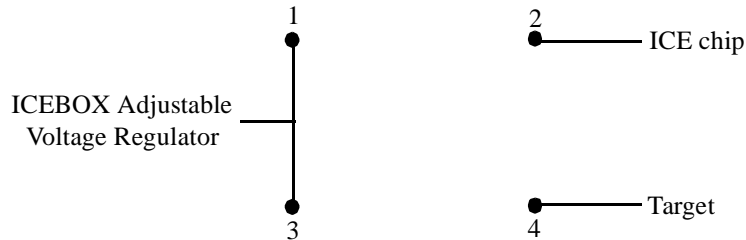

**Figure 3. J1 Jumper Schematic**

### Connect the Power Supply

1. If the power supply allows voltage adjustment:
  - Turn the power supply on and adjust it to +5 V
  - Adjust the limiting adjustment, if present, to at least 2.5 A
2. Turn the supply off.
3. Locate the power cable (red wire, black wire, and banana plugs on the other end). Plug in the black banana plug into the black jack on the power supply (labeled COM, GND, or with the ground symbol). Plug the red plug into the red jack on the power supply (labeled +, + V or +5 V).
4. Plug the white connector on the other end of the cable into the matching 4-pin connector on the back side of the ICEBOX. This connection is keyed to ensure against an improper connection.

➤ **Note:** The ZiLOG Power Supply Accessory Kit (ZPS05V00ZAC), which is sold separately, provides a fixed-5 V Universal Output Power Supply, accepts 110 V to 220 V AC input, and includes a power cable and an in-line jack cable.



**Caution:** Always check the supply voltage before plugging in the power cord.



## Connect the Serial Cable to the PC

Locate the serial cable. Connect the male end to the female connector on the back of the ICEBOX, and the female end to either the COM1, COM2, COM3, or COM4 connector of the host PC, see Figure 1.

- **Note:** If connector availability is limited to a 9-pin COM1 through COM4, then use either a different cable or a 25-pin to 9-pin converter. This converter is available at any electronics store for a nominal fee.

## Connect to the Design

Perform the following steps to connect to the target design:



**Caution:** Wear a properly grounded wrist strap or similar ESD protection before continuing.

1. Locate the emulation cable for the device.
2. Plug the cable into the target device. Ensure that the pin 1 marking (as indicated by the red mark on the ribbon cable) matches pin 1 on the target board.
3. Plug the other end of the cables into target pod on top of the ICEBOX. See Figure 2 for the location of the target pod.
4. Select the power source for the ICE chip by configuring the J1 jumper. See Table 4 for more information on jumper settings and Figure 2 for the location of the J1 jumper.
5. If the target and ICEBOX are using separate power supplies, ensure that the ICE chip voltage matches the target's device voltage. Adjust the voltage by performing the following steps:
  - a. Measure the voltage of your target.
  - b. Locate the voltage adjuster on top of the ICEBOX. See Figure 2 for the location of the voltage adjuster



- c. Attach the voltmeter lead to either pin 1 or 3 on the J1 jumper and ground.
- d. Power the ICEBOX with the target device disconnected.
- e. Turn the voltage adjuster's screw until the voltmeter's read-out matches the target device's voltage.



**Caution:** Failure to match the target devices voltage with the ICE chip's voltage could result in damage to the ICEBOX, target device, or ICE chip.

### Power the ICEBOX

If anything unusual (such as an unexpected sound and/or smell) occurs when turning on the power supply, turn off the power supply and check the setting for the J1 jumper. See Set Power Jumper on page 12. If the power supply allows voltage adjustment, adjust it again to +5 V. The power supply output may measure less than +5 V because of the load of the ICEBOX. If your power supply has a current meter, ensure that the ICEBOX is drawing within the rated current.

After power-up, press the RESET button to reset the ICE chip. (Pressing the RESET button avoids bus contention on the I/O lines.) If the ICEBOX is not powering your design through the  $V_{CC}$  pin, turn on the power supply of the design.



**Caution:** If your design already has a power supply, do not power your design from the ICEBOX  $V_{CC}$  pin.

When powering down, follow the procedure described below:

1. Halt emulation.
2. In ZDS select Reset from the Build or Debug Menu.
3. Power down the target application board (if using its own power supply).
4. Power down the ICEBOX.



- ▶ **Note:** Refer to the complete Electrical Safeguards shown in the preface of this manual.

## Installing a New ICE Chip

The Z86C36 ICEBOX comes with the Z86C51 ICE chip. Under ordinary circumstances, the user should never have to remove this ICE chip. If for some reason the ICE chip needs to be replaced, follow the procedures below. See Figure 4 and Figure 5 for more information.

- ▶ **Note:** Replace the Z86C51 ICE chip with the Z86C50 ICE chip to support devices with 32K code size or less.



**Caution:** Failure to follow the procedures below could result in damage to the ICEBOX.

Perform the following steps to replace the ICE chip.

1. Disconnect all power to the ICEBOX
2. Move the ICEBOX ziff socket labeled U1 to the upright position and remove the ICE chip. See Figure 2 for the location of the ziff socket.
3. Place the new ICE chip into the U1 ziff socket. Ensure that the ICE chip's pin 1 matches pin 1 on the U1 ziff socket.
4. Close the ziff socket locking lever.

- ▶ **Note:** A dot in the corner of the processor indicates the chip's pin 1 location.

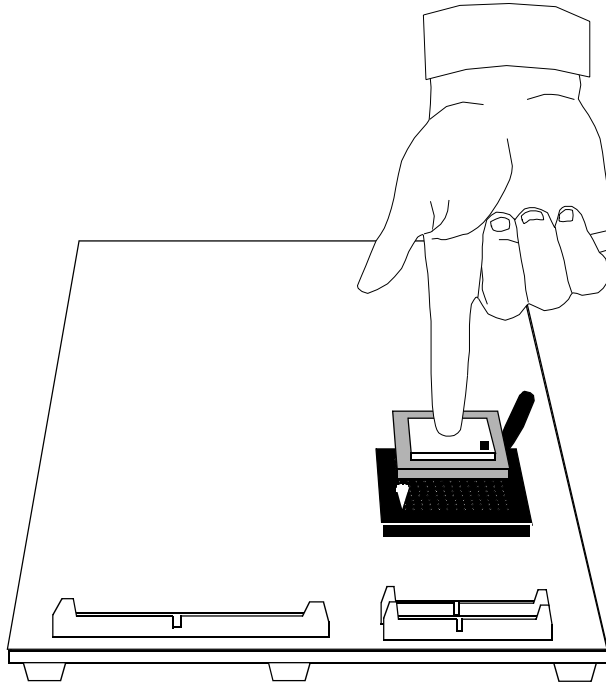

**Figure 4. ICE Chip Installation**

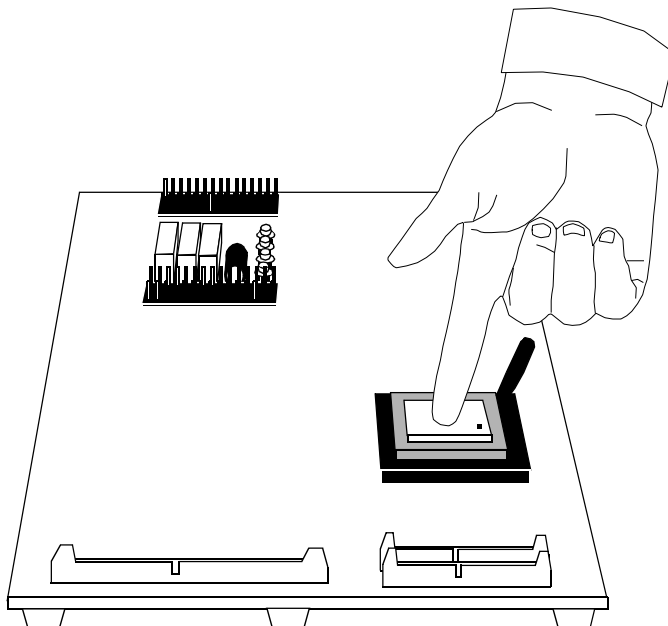

**Figure 5. Closing the ICE Chip Locking Lever**

## SOFTWARE INSTALLATION

For more information on installing ZDS, refer to the user manual that is included on the installation CD-ROM or download ZDS literature from the ZiLOG web page at [www.zilog.com](http://www.zilog.com).

## ICEBOX OPERATION

The following topics guide the user on how to operate the ICEBOX and configure jumper settings.



## Resetting

Press the RESET button on the ICEBOX to reset the state of the target device and the status that was established using ZDS.

For example, the ICEBOX sets the program counter to 000Ch.

After reset, wait until the Ready LED is ON and has finished blinking before starting ZDS. Refer to the LED Operation section of this chapter for more details.

- **Note:** Always press the RESET button on the ICEBOX before starting ZDS.

## LED Operation

ZiLOG ICEBOXes use LEDs to communicate the different hardware states. The following table gives a description of the LEDs. The ICEBOX's LED's are located on the right front of the ICEBOX. See Table 3.

**Table 3. Front LED Assignments**

LED	Indication	Description
READY	On	Communicating in Bisync Mode and waiting for command
	Off	Communicating in ASCII Mode or executing Bisync command
RUN	On	Running user code
	Off	Not running user code
OTP	On	The ICEBOX is performing OTP programming
	Off	The ICEBOX completed OTP programming
PWR	On	ICEBOX is powered up and Self Test is completed
	Off	Power is off
	Blink	ICEBOX is self-testing



## Jumper Settings

Table 4 lists jumper settings that are easily configured by the user. See Figure 2 for the location of the jumpers.

**Table 4. Jumper Settings**

Jumper	Pin	Position	Description
J1	1-2	In	Powers the ICE chip with ICEBOX's adjustable voltage regulator (default), for more information see Figure 3
J1	3-4	In	Powers the Target with ICEBOX's adjustable voltage regulator
J1	2-4	In	Target powers the ICE chip
J2	1-2	In	Y2 Crystal to XTAL2
J2	2-3	In	User Crystal to XTAL2
J3	1-2	In	Y2 Crystal to XTAL1
J3	2-3	In	User Crystal to XTAL1
J3	2-4	In	Canned Oscillator to XTAL1 (Default)
J5	1-2	In	Not installed (factory settings)
J6	2-4	In	Enable if P3.4 used for external memory/DM ( <i>see note</i> )
J6	2-3	In	P3.4 not used (default)
J6	1-2	In	Ground signal
J7	1-2	In	Default setting
J7	2-3	In	Output of PAL (Programmable Array Logic)/not used

- **Note:** Port 3 pin 4 can be used as an output pin or an external memory indicator. If P3.4 is used for external memory and not data memory, then jumper pin 2 to pin 4 on the J6 jumper.





The user can adjust the voltage of the ICE chip to match the target's voltage using the ICEBOX's R55 Voltage Adjuster. See Figure 2 for the location of the voltage adjuster.



This page intentionally left blank.

## 3 *Overview*

### USING ZDS

This ICEBOX is fully compatible with ZiLOG Developer Studio (ZDS) software. The following steps briefly describe the procedures necessary to setup and create projects with the Z86C36 ICEBOX. A summary of the ICEBOX's available debug windows is also included at the end of this chapter.

For more detailed information on using ZDS, refer to the ZDS User Manual (in PDF format) located on the installation CD-ROM, or download the latest information from our web site at [www.zilog.com](http://www.zilog.com).

### Select the ICEBOX

Perform the following steps to select the ICEBOX and create a new project:

1. Open ZDS by selecting Start>Programs>Zilog Developer Studio>ZDS.
2. Choose New Project from the File menu. The New Project dialog box appears as show in Figure 6.

► **Note:** If the project has already been created, select Target from the Project menu and perform the following steps that are applicable for the ZiLOG MCU Database dialog box.

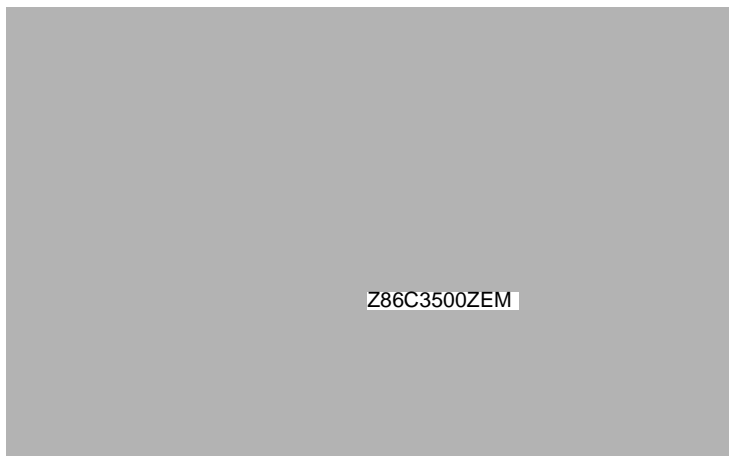

**Figure 6. New Project Dialog Box**

3. Select Family in the Selection by field.
4. Select Z8 from the Master pop-up list.
5. Select a microcontroller from the Z8 family in the Project Target pop-up list.
6. Select Z86C3500ZEM or Z86C3600ZEM in the Emulator pop-up list.

► **Note:** The Z86C3600ZEM becomes the Z86C3500ZEM when you use a Z86C50 ICE chip.

7. Click on the browse button (...) in the Project Name field. The New Project Browser dialog box appears.
8. Enter the project file name and select a path in the New Project Browse dialog box.



- ▶ **Note:** All build output files, such as linker and assembly files are saved in the same directory as the project.
  9. Click Save. The project name appears in the Project Name field in the New Project dialog box.
  10. Click on Chip Data to view the microcontroller specifications.
- ▶ **Note:** Fields in the Chip Data page are read-only and can not be modified.
  11. Click OK. The new project is saved as the name specified in the New Project Browse dialog box.
  12. Select Emulator Configuration from the Project menu. The Emulator Configuration dialog box appears, as shown in Figure 7.



**Figure 7. Emulator Configuration Dialog Box**



13. Ensure that Emulator is selected in the Module field.
14. Select the port the ICEBOX is connected to from the Port pop-up list.
15. Select 57600 from the Baud Rate pop-up list.
16. Click OK to close and apply the Emulator Configuration options.
17. Select Save Project from the File menu to save the emulator configuration setting.

## Open a Project and Add Files

A previously created project has the following attributes saved with it:

- Target settings
- Assembler and Linker settings for the specified target
- Source files (including header files)

► **Note:** Use the Project Viewer window to view and access the various files in any given project.

Perform the following steps to open a previously created project:

1. Select Open Project from the File menu. The Open Project dialog box appears.
2. In the Open Project dialog box, select the previously created project. The project appears in the Project Viewer window, as shown in Figure 8.



**Figure 8. Project Viewer Window**

### **Add an Existing File**

Perform the following steps to add an existing file to a project:

1. Select Add to Project>Files from the Project menu. The Insert Files into Project dialog box appears, as shown in Figure 9.



**Figure 9. Insert Files into Project Dialog Box**

2. Select the file to add to the project.



3. Click Open. The file appears in the Project Viewer window, as shown in Figure 10.



**Figure 10. Project Viewer Window with File**

4. Double-click on the file in the Project Viewer window. The file appears in the ZDS main Edit window.

► **Note:** In some cases, non-editable files, such as `.obj` files need to be included in a project. These files are displayed in the source file list, but cannot be opened. When the project is built, these files are automatically linked.

5. Select Update All Dependencies from the Build menu. The Dependencies folder list in the Project Viewer window is updated.

### **Add a New File**

1. Select Add to Project>New from the Project menu. The Insert New Files Into Project dialog box appears.
2. Type a file name in the File Name field.
3. Click Open. The new file name appears in the Project Viewer window with a `.asm` suffix, and a blank Edit window also appears.

► **Note:** Header and Included files do not have to be added. The program detects those called by the source code.







**AVAILABLE DEBUG WINDOWS**

Table 5 lists the debug windows that are available using ZDS.

**Table 5. Debug Windows**

Window	Function	Updated values display in red
Watch	 <ul style="list-style-type: none"> <li>Shows the symbols and the contents of the registers (see the ZDS user manual for more information)</li> </ul>	
Z8 Standard Registers	<ul style="list-style-type: none"> <li>Shows the contents of the Z8 standard registers</li> </ul>	
Code Memory	 <ul style="list-style-type: none"> <li>Allows the user to monitor, edit, and download a .ld file or a .hex file into Code Memory from generated assembly source code</li> <li>Tracks a specific address entered in the Code Address edit box</li> </ul>	
Disassembly	<ul style="list-style-type: none"> <li>Shows code memory along with the corresponding disassembled code</li> <li>Allows the user to edit, and download a file.ld or file.hex into the Code memory</li> <li>Follows the program counter</li> <li>Provides a complete scroll down with this window, however the scroll up is limited</li> <li>Accesses the disassembly of code at the address specified in the Code Address field</li> <li>The Disassembly window is automatically displayed when debugging hex code or whenever there is no corresponding source file available at the address specified by the program counter</li> </ul>	



**Table 5. Debug Windows (Continued)**

Window	Function	Updated values display in red
Z8 Register File	<ul style="list-style-type: none"> <li>• Shows all Z8 internal and external registers, all RAM pointer and data registers, status registers and status flags, and stacks</li> <li>• Monitor and edit write-able registers in this window</li> </ul>	
Z8 Expanded Register	<ul style="list-style-type: none"> <li>• Displays the Z8 Expanded Register banks that are specified in the configuration</li> <li>• Monitor and edit write-able registers directly in this window by selecting a specific bank tab</li> </ul>	
Working Registers	<ul style="list-style-type: none"> <li>• Modify and view working registers in this window</li> </ul>	
Timer Counter Registers	<ul style="list-style-type: none"> <li>• Modify and view the timer/counter registers in this window</li> </ul>	
Ports Register	<ul style="list-style-type: none"> <li>• Monitor and edit port registers in this window</li> </ul>	

# *Appendix A: Troubleshooting Guide*

## INTRODUCTION

Before contacting a ZiLOG representative or submitting a Problem Report, please follow these simple steps. Also, check the Precautions and Limitations sections in the Product Information document included with the emulator to eliminate other possible known problems. If a hardware failure is suspected, contact a local ZiLOG representative for assistance.

## ERROR OPENING SERIAL PORT

If the initial ZiLOG screen is not appearing after selecting the COM port and the screen message displays Time-out while reading:

1. Check the RS-232C cable connection and communication port selection in ZDS. See Select the ICEBOX on page 23 for more information on how to configure the host PC's port.
2. Reset the emulator and ZDS.
3. Try connecting another cable.
4. Check if transmit/receive signals need to be swapped.

► **Note:** On some DB9 connectors for the COM ports, the transmit/receive signal may be swapped and a Null Modem adapter may be required.

5. Ensure that the power supply is connected, is turned on, and power is available.
6. Ensure that the power supply is set at the correct voltage.



7. Ensure that the J1 power jumper has been properly configured. See Set Power Jumper on page 12 for more information on setting the J1 jumper.
8. Check if power supply is supplying the required current (2.5 A typical) to the emulator.
9. Check selected the port using another application or select another COM port.
10. After resetting the emulator, wait a minimum of 5 seconds before running ZDS.

## COUNTER JUMPS TO UNEXPECTED ADDRESS

Any instruction other than a DI instruction is used to disable interrupts. Possible causes include:

- The stack overflows into the general register locations.
- Extra POP, PUSH, IRET, or RET is encountered (stack unbalanced).
- Program resets repeatedly.
  - Program counter rolls over from value FFFF to 0000 and proceeds back to the beginning of program.
  - Watch-Dog Timer (WDT) is not initialized or refreshed.
- Uninitialized interrupt vector is activated. The interrupt vector is not set to the interrupt handler.

## ZDS ERROR MESSAGES

### Can Not Open Windows

If this message appears while attempting to open a window ZDS, there may not be enough memory within the Microsoft Windows environment



to properly run ZDS. Try closing the other active applications or exit and re-enter the Microsoft Windows environment.

## **Out of Synchronization with the Emulator**

This message appears whenever communication between the emulator and the PC is interrupted.

1. Ensure that the power cable is connected.
2. Ensure that the RS-232C cable is connected.
3. Change the baud rate setting (default is 19200). A lower setting usually improves communications reliability.
4. Reestablish communication between ZDS and the emulator. See the ZDS on-line help for more information on establishing communication with an emulator.



This page intentionally left blank.

## *Appendix B: ASCII Character Set*

**Table 6. ASCII Character Set**

<b>Graphic</b>	<b>Decimal</b>	<b>Hexadecimal</b>	<b>Comments</b>
	0	0	Null
	1	1	Start Of Heading
	2	2	Start Of Text
	3	3	End Of Text
	4	4	End Or Transmission
	5	5	Enquiry
	6	6	Acknowledge
	7	7	Bell
	8	8	Backspace
	9	9	Horizontal Tabulation
	10	A	Line Feed
	11	B	Vertical Tabulation
	12	C	Form Feed
	13	D	Carriage Return
	14	E	Shift Out
	15	F	Shift In
	16	10	Data Link Escape
	17	11	Device Control 1
	18	12	Device Control 2



**Table 6. ASCII Character Set (Continued)**

<b>Graphic</b>	<b>Decimal</b>	<b>Hexadecimal</b>	<b>Comments</b>
	19	13	Device Control 3
	20	14	Device Control 4
	21	15	Negative Acknowledge
	22	16	Synchronous Idle
	23	17	End Of Block
	24	18	Cancel
	25	19	End Of Medium
	26	1A	Substitute
	27	1B	Escape
	28	1C	File Separator
	29	1D	Group Separator
	30	1E	Record Separator
	31	1F	Unit Separator
	32	20	Space
!	33	21	Exclamation Point
"	34	22	Quotation Mark
#	35	23	Number Sign
\$	36	24	Dollar Sign
%	37	25	Percent Sign
&	38	26	Ampersand
'	39	27	Apostrophe
(	40	28	Opening (Left) Parenthesis
)	41	29	Closing (Right) Parenthesis



**Table 6. ASCII Character Set (Continued)**

<b>Graphic</b>	<b>Decimal</b>	<b>Hexadecimal</b>	<b>Comments</b>
*	42	2A	Asterisk
+	43	2B	Plus
,	44	2C	Comma
-	45	2D	Hyphen (Minus)
.	46	2E	Period
/	47	2F	Slant
0	48	30	Zero
1	49	31	One
2	50	32	Two
3	51	33	Three
4	52	34	Four
5	53	35	Five
6	54	36	Six
7	55	37	Seven
8	56	38	Eight
9	57	39	Nine
:	58	3A	Colon
;	59	3B	Semicolon
<	60	3C	Less Than
=	61	3D	Equals
>	62	3E	Greater Than
?	63	3F	Question Mark
@	64	40	Commercial At



Table 6. ASCII Character Set (Continued)

Graphic	Decimal	Hexadecimal	Comments
A	65	41	Uppercase A
B	66	42	Uppercase B
C	67	43	Uppercase C
D	68	44	Uppercase D
E	69	45	Uppercase E
F	70	46	Uppercase F
G	71	47	Uppercase G
H	72	48	Uppercase H
I	73	49	Uppercase I
J	74	4A	Uppercase J
K	75	4B	Uppercase K
L	76	4C	Uppercase L
M	77	4D	Uppercase M
N	78	4E	Uppercase N
O	79	4F	Uppercase O
P	80	50	Uppercase P
Q	81	51	Uppercase Q
R	82	52	Uppercase R
S	83	53	Uppercase S
T	84	54	Uppercase T
U	85	55	Uppercase U
V	86	56	Uppercase V
W	87	57	Uppercase W

**Table 6. ASCII Character Set (Continued)**

<b>Graphic</b>	<b>Decimal</b>	<b>Hexadecimal</b>	<b>Comments</b>
X	88	58	Uppercase X
Y	89	59	Uppercase Y
Z	90	5A	Uppercase Z
[	91	5B	Opening (Left) Bracket
\	92	5C	Reverse Slant
]	93	5D	Closing (Right) Bracket
^	94	5E	Circumflex
_	95	5F	Underscore
`	96	60	Grave Accent
a	97	61	Lowercase A
b	98	62	Lowercase B
c	99	63	Lowercase C
d	100	64	Lowercase D
e	101	65	Lowercase E
f	102	66	Lowercase F
g	103	67	Lowercase G
h	104	68	Lowercase H
i	105	69	Lowercase I
j	106	6A	Lowercase J
k	107	6B	Lowercase K
l	108	6C	Lowercase L
m	109	6D	Lowercase M
n	110	6E	Lowercase N



**Table 6. ASCII Character Set (Continued)**

<b>Graphic</b>	<b>Decimal</b>	<b>Hexadecimal</b>	<b>Comments</b>
o	111	6F	Lowercase O
p	112	70	Lowercase P
q	113	71	Lowercase Q
r	114	72	Lowercase R
s	115	73	Lowercase S
t	116	74	Lowercase T
u	117	75	Lowercase U
v	118	76	Lowercase V
w	119	77	Lowercase W
x	120	78	Lowercase X
y	121	79	Lowercase Y
z	122	7A	Lowercase Z
{	123	7B	Opening (Left) Brace
	124	7C	Vertical Line
}	125	7D	Closing (Right) Brace
~	126	7E	Tilde
	127	7F	Delete

## *Appendix C: Problem/Suggestion Report Form*

If you experience any problems while operating this product, or if you note any inaccuracies while reading the user manual, please copy this form, fill it out, then mail or fax it to ZiLOG. We also welcome your suggestions!

### **Customer Information**

Name	_____	Country	_____
Company	_____	Telephone	_____
Address	_____	Fax Number	_____
City/State/ZIP	_____	E-Mail Address	_____

### **Product Information Return Information**

Serial # or Board Fab #/Rev. #	<b>ZiLOG, Inc.</b>
Software Version	System Test/Customer Support
Manual Number	910 E. Hamilton Ave., Suite 110, MS 4-3
Host Computer Description/Type	Campbell, CA 95008
	Fax Number: (408) 558-8536
	Email: tools@zilog.com

### **Problem Description or Suggestion**

Provide a complete description of the problem or your suggestion. If you are reporting a specific problem, include all steps leading up to the occurrence of the problem. Attach additional pages as necessary.

---



---



---



This page intentionally left blank.

## *Glossary*

ASCII	American Standard Code of Information Interchange.
Baud	Unit of measure of transmission capacity.
Binary	Number system based on 2. A binary digit is a bit.
BISYNC	Bidirectional Synchronous Communication Protocol.
Bit	A digit of a binary system. It has only two possible values: 0 or 1.
BPS	Bits Per Second. Number of binary digits transmitted every second during a data-transfer procedure.
Bus	In Electronics, a parallel interconnection of the internal units of a system that enables data transfer and control Information.
Byte	A collection of four sequential bits of memory. Two sequential bytes (8 bits) comprise one word.
COM	Device name used to designate a communication port.
DIP	Dual In-line Package. The plastic housing designed to be attached directly to a circuit board or equipment case.



Emulation	Process of duplicating the behavior of one product or part using another medium.
Emulator	An emulation device. For example, an In-Circuit Emulator (ICE) module duplicates the behavior of the chip it emulates in the circuit being tested.
GUI	Graphical User Interface. The windows and text that a user sees on their computer screen when they are using a program.
ICE	In-Circuit Emulator. A ZiLOG product which supports the application design process.
Icon	A small screen image representing a specific element like a document, embedded and linked objects, or a collection of programs gathered together in a group.
Initialize	To establish start-up parameters, typically involving clearing all of some part of the device's memory space.
Instruction	Command.
I/O	Input/Output. In computers, the part of the system that deals with interfacing to external devices for input or output, such as keyboards or printers.
MCU	Microcontroller or Microcomputer Unit.
OTP	One-Time Programmable.
PC	Personal computer, program counter.





POP	Retrieve a Value from the Stack.
Port	The point at which a communications circuit terminates at a Network, Serial, or Parallel Interface card.
PUSH	Store a Value In the Stack.
RA	Relative Address.
RAM	Random-Access Memory. A memory that can be written to or read at random. The device is usually volatile, which means the data is lost without power.
RS-232C	Electronic Industries Association Standard for Asynchronous Transmissions Between a Computer and a Peripheral Device.
SOIC	Small Outline IC.
SVGA	Super Video Graphics Adapter.
TMR	Timer Mode Register.
UART	Universal Asynchronous Receiver Transmitter. Component or functional block that handles asynchronous communications. Converts the data from the parallel format in which it is stored, to the serial format for transmission.
V	Volt, Overflow Flag.
V <sub>CC</sub>	Supply Voltage.



WDT	Watch-Dog Timer. A timer that, when enabled under normal operating conditions, must be reset within the time period set within the application (WDTMR (1,0)). If the timer is not reset, a Power-on Reset occurs. Some earlier manuals refer to this timer as the WDTMR.
Word	Amount of data a processor can hold in its registers and process at one time. A DSP word is often 16 bits. Given the same clock rate, a 16-bit controller processes four bytes in the same time it takes an 8-bit controller to process two.
XTAL	Crystal.
Z8	ZiLOG Chip.
ZDS	ZiLOG Developer Studio. ZiLOG's program development environment for Windows 95/98/NT.
Z	locatable object modules for the ZiLOG family of microcontrollers.
ZMASM	ZiLOG Macro Cross Assembler. ZiLOG's program development environment for Windows 3.1.



# *Index*

## **A**

Adjust the voltage 14  
Appendix A 31, 35, 41  
ASCII Character Set 35  
Available Debug Windows 29

## **C**

Chip Data 25  
Choosing the IceChip 15  
Clocks 4  
Connect to Your Design 14

## **E**

Error Messages 32

## **H**

Header and Included files 28

## **I**

Index 47  
Insert Files 27  
Installation 9, 23  
installation instructions 12

## **J**

jumper settings 18

## **K**

Kit Contents 5

## **L**

LED Operation 19  
List of Figures v  
List of Tables vii

## **O**

Overview 1

## **P**

power supply 13  
    adjusting 13  
    problems 15  
    settings 9  
powering down 15

## **Q**

Quick installation 9



## **R**

Requirements 6

RESET 15

Resetting 19

## **S**

Selecting the emulator 23

serial cable 14

Software Installation 18

Software Setup 23

## **T**

Table of Contents iii

Target connectors 11

## **V**

voltage adjuster 14

## **Z**

### **ZDS**

adding files 26

Create a New Project 23

Debug windows 29

New Project 25

obj files 28

Open a project 26

Project Viewer window 28

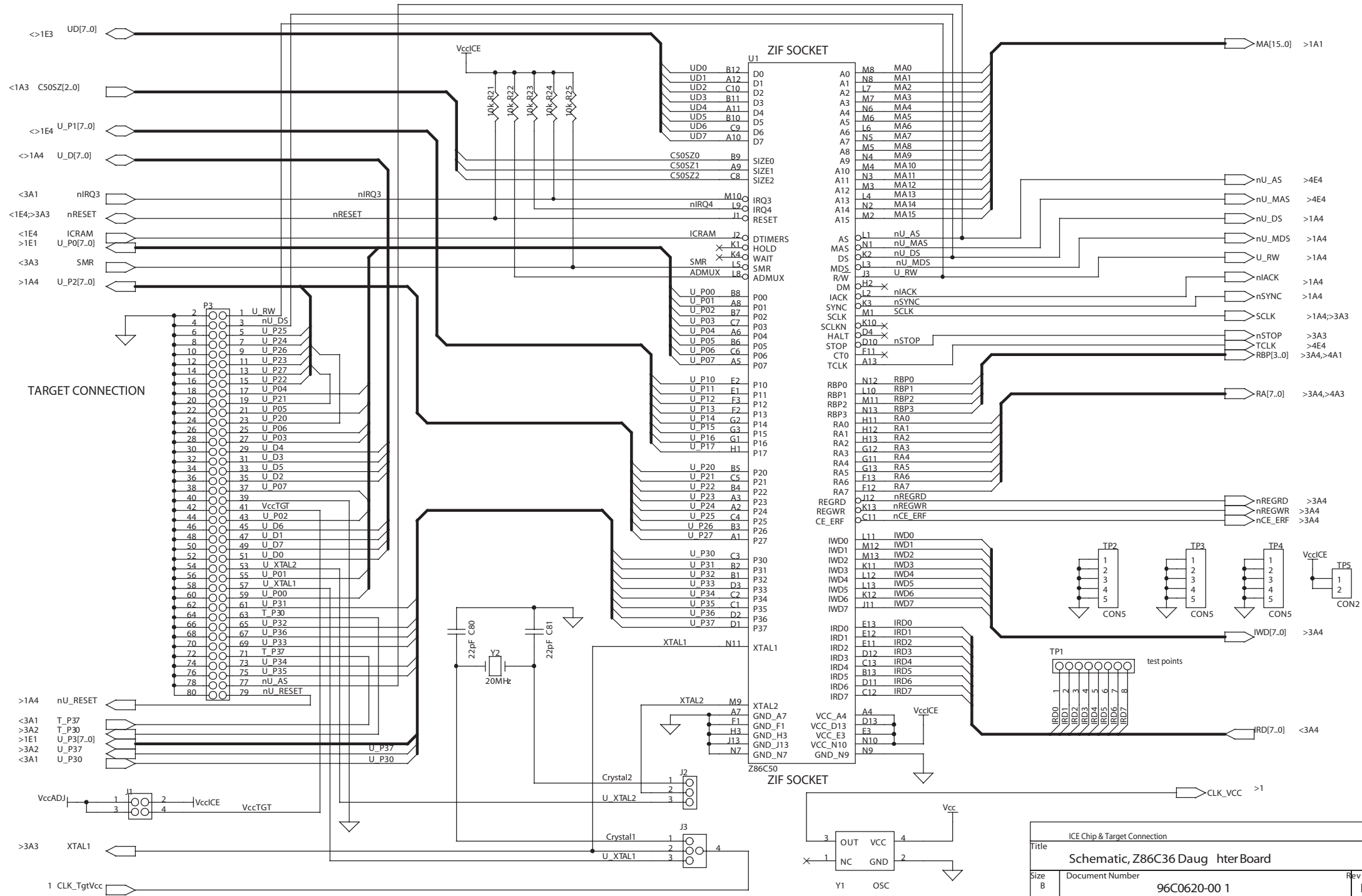

ICE Chip & Target Connection		
Title	Schematic, Z86C36 Daug hter Board	
Size	Document Number	Rev
B	96C0620-00 1	B
Date:	Tuesday, July 27, 1999	Sheet 1 of 4

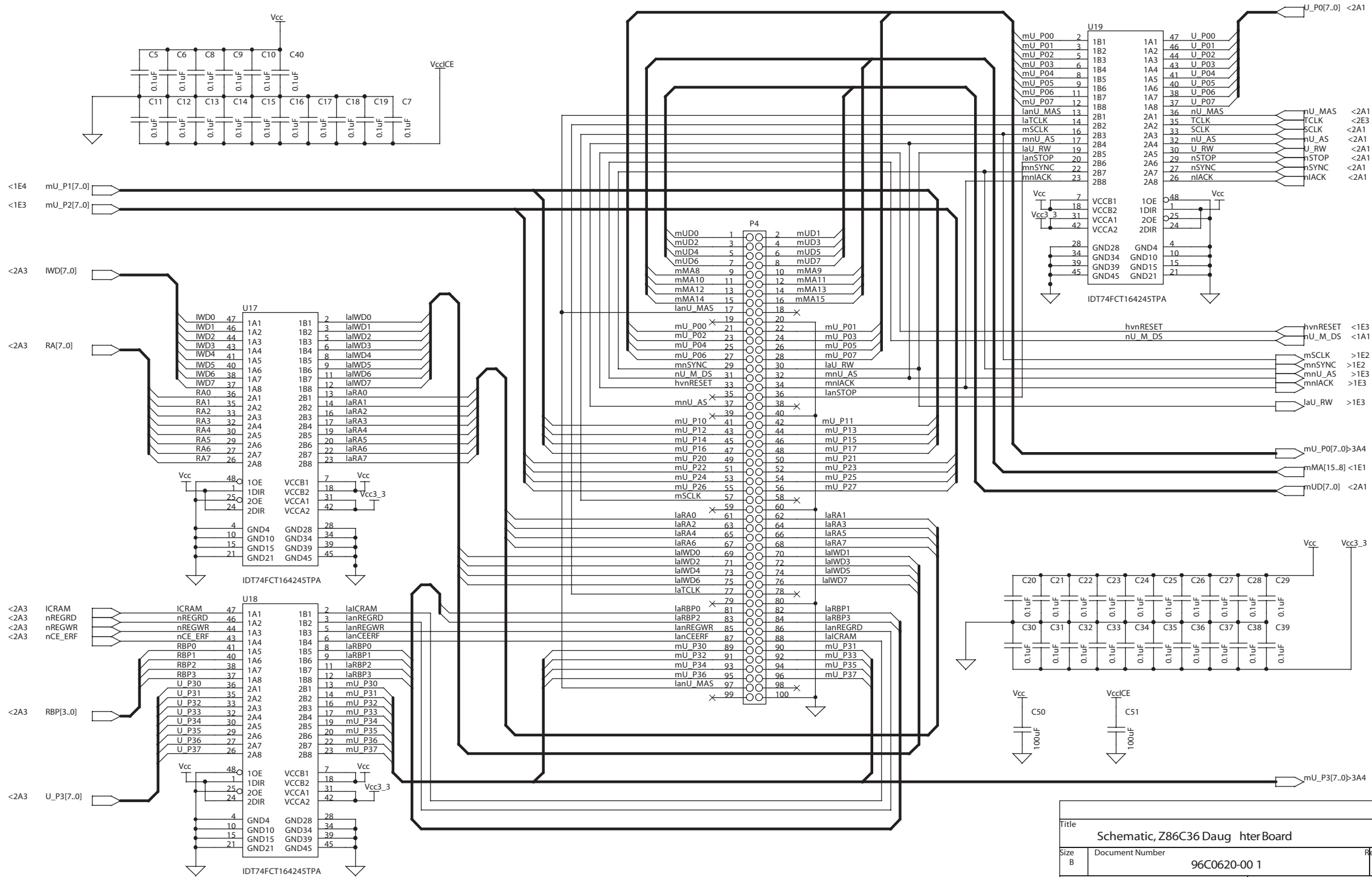

Title		
Schematic, Z86C36 Daug hter Board		
Size	Document Number	Rev
B	96C0620-00 1	B
Date:	Tuesday, July 27, 1999	Sheet 2 of 4

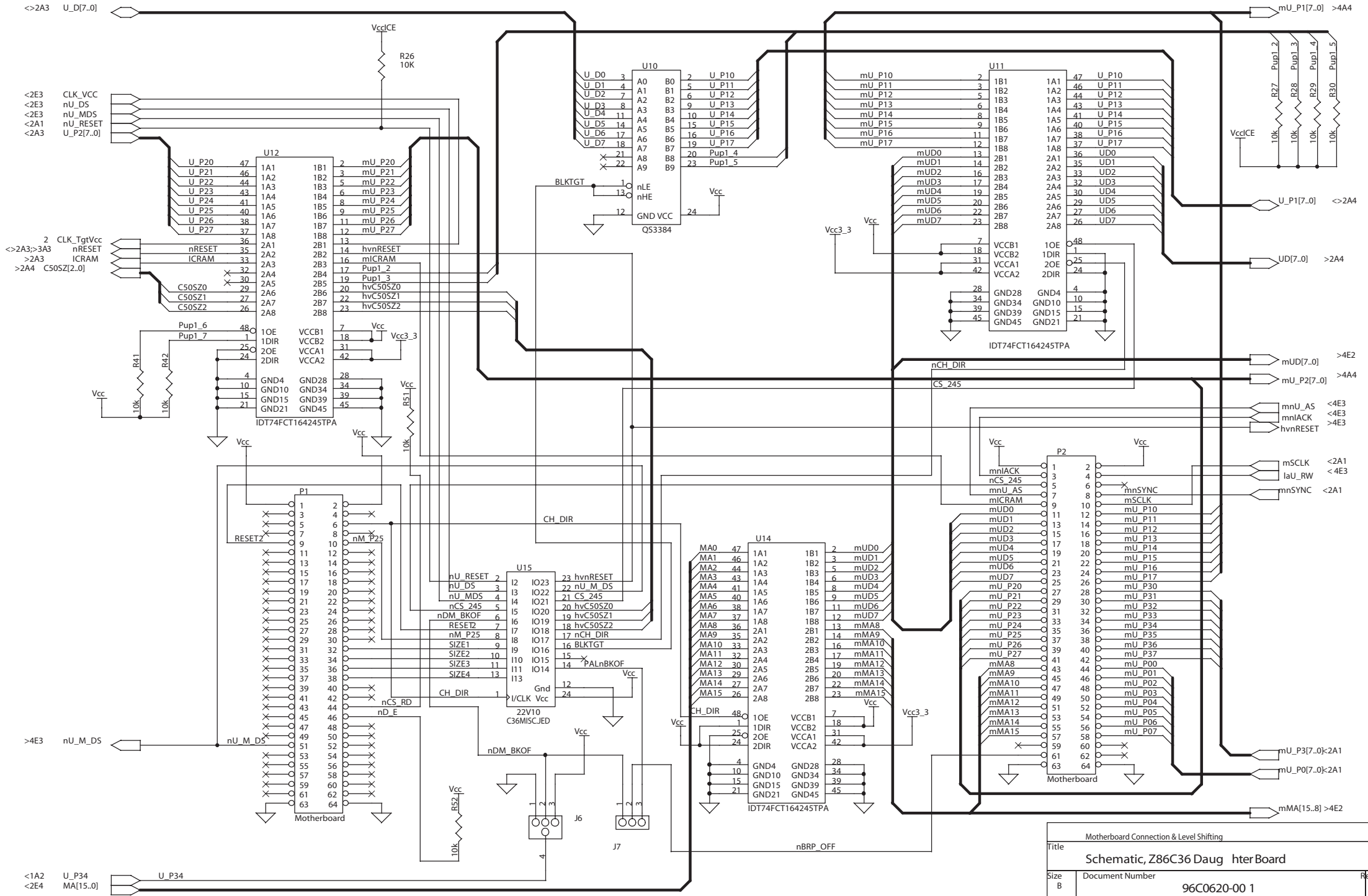

Motherboard Connection & Level Shifting			
Title	Schematic, Z86C36 Daug hter Board		
Size	Document Number	96C0620-00 1	Rev
B			B
Date:	Tuesday, July 27, 1999	Sheet	3 of 4

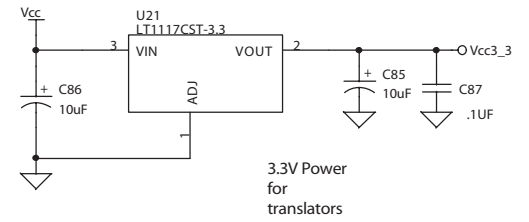
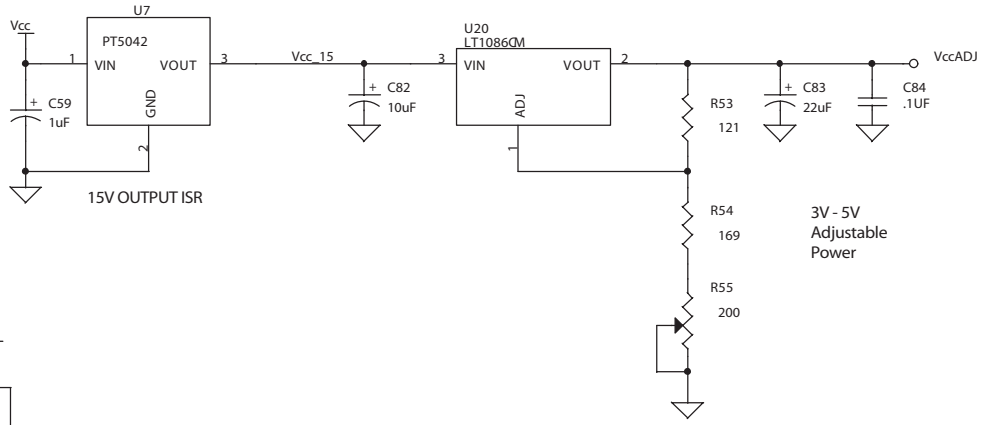
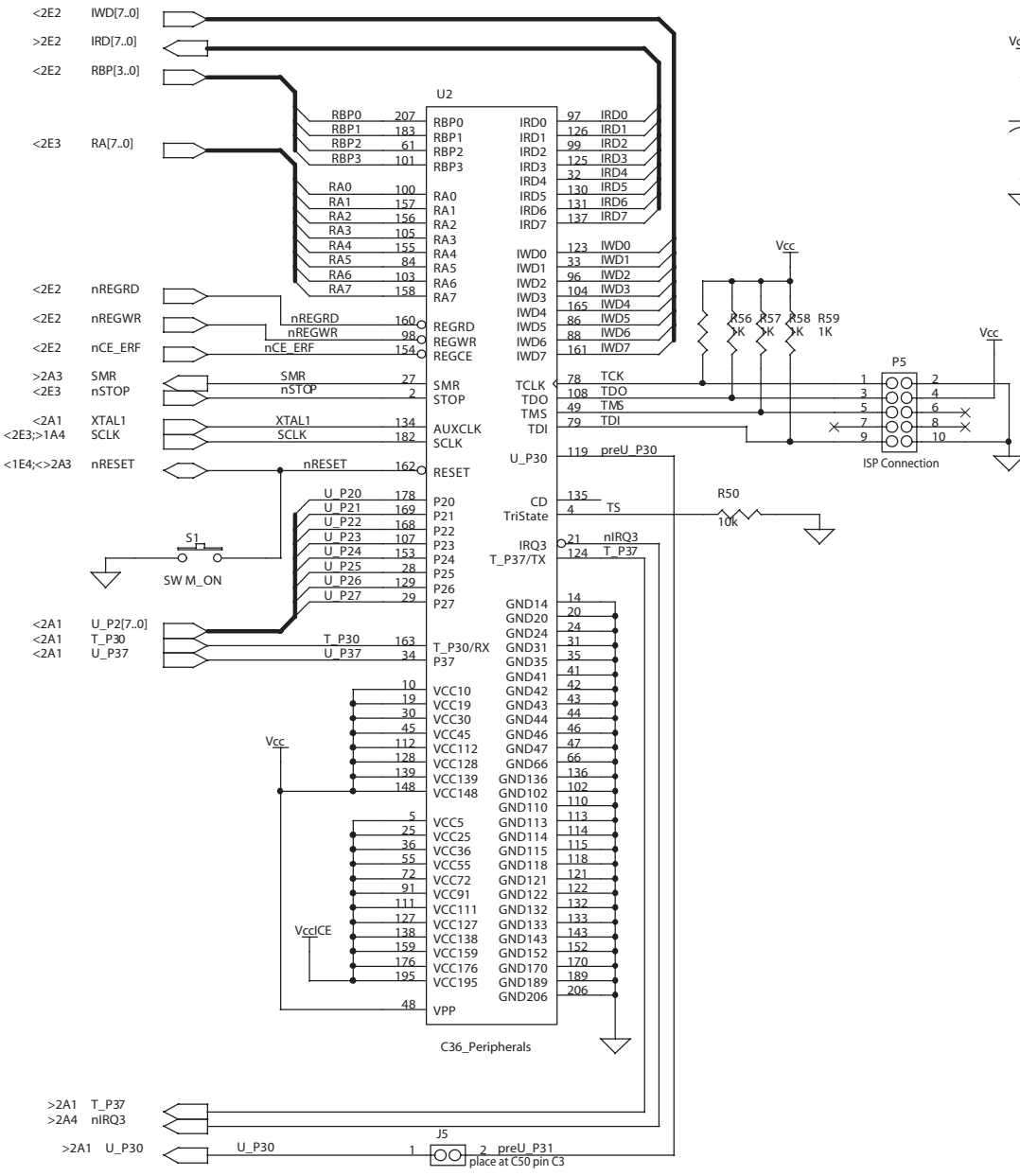

Peripherals PLD, OTP Circuit		
Title		
Schematic, Z86C36 Daug hterBoard		
Size	Document Number	Rev
B	96C0620-00 1	B
Date:	Tuesday, July 27, 1999	Sheet 4 of 4