



Tsi381™ Evaluation Board User Manual

60E2000_MA001_03

September 2009

6024 Silver Creek Valley Road, San Jose, California 95138
Telephone: (800) 345-7015 • (408) 284-8200 • FAX: (408) 284-2775
Printed in U.S.A.
©2009 Integrated Device Technology, Inc.

GENERAL DISCLAIMER

Integrated Device Technology, Inc. reserves the right to make changes to its products or specifications at any time, without notice, in order to improve design or performance and to supply the best possible product. IDT does not assume any responsibility for use of any circuitry described other than the circuitry embodied in an IDT product. The Company makes no representations that circuitry described herein is free from patent infringement or other rights of third parties which may result from its use. No license is granted by implication or otherwise under any patent, patent rights or other rights, of Integrated Device Technology, Inc.

CODE DISCLAIMER

Code examples provided by IDT are for illustrative purposes only and should not be relied upon for developing applications. Any use of the code examples below is completely at your own risk. IDT MAKES NO REPRESENTATIONS OR WARRANTIES OF ANY KIND CONCERNING THE NONINFRINGEMENT, QUALITY, SAFETY OR SUITABILITY OF THE CODE, EITHER EXPRESS OR IMPLIED, INCLUDING WITHOUT LIMITATION ANY IMPLIED WARRANTIES OF MERCHANTABILITY, FITNESS FOR A PARTICULAR PURPOSE, OR NON-INFRINGEMENT. FURTHER, IDT MAKES NO REPRESENTATIONS OR WARRANTIES AS TO THE TRUTH, ACCURACY OR COMPLETENESS OF ANY STATEMENTS, INFORMATION OR MATERIALS CONCERNING CODE EXAMPLES CONTAINED IN ANY IDT PUBLICATION OR PUBLIC DISCLOSURE OR THAT IS CONTAINED ON ANY IDT INTERNET SITE. IN NO EVENT WILL IDT BE LIABLE FOR ANY DIRECT, CONSEQUENTIAL, INCIDENTAL, INDIRECT, PUNITIVE OR SPECIAL DAMAGES, HOWEVER THEY MAY ARISE, AND EVEN IF IDT HAS BEEN PREVIOUSLY ADVISED ABOUT THE POSSIBILITY OF SUCH DAMAGES. The code examples also may be subject to United States export control laws and may be subject to the export or import laws of other countries and it is your responsibility to comply with any applicable laws or regulations.

LIFE SUPPORT POLICY

Integrated Device Technology's products are not authorized for use as critical components in life support devices or systems unless a specific written agreement pertaining to such intended use is executed between the manufacturer and an officer of IDT.

1. Life support devices or systems are devices or systems which (a) are intended for surgical implant into the body or (b) support or sustain life and whose failure to perform, when properly used in accordance with instructions for use provided in the labeling, can be reasonably expected to result in a significant injury to the user.
2. A critical component is any components of a life support device or system whose failure to perform can be reasonably expected to cause the failure of the life support device or system, or to affect its safety or effectiveness.

IDT, the IDT logo, and Integrated Device Technology are trademarks or registered trademarks of Integrated Device Technology, Inc.

Contents

About this Document.	5
Related Information	5
Acronyms	5
Revision History	5
1. Board Design	7
1.1 Overview	7
1.2 PCI Interface	9
1.2.1 Overview	9
1.2.2 IDSEL Signals	9
1.2.3 Interrupt Signals	9
1.2.4 Pull-up Signals	9
1.3 PCIe Interface	10
1.4 Power Management	10
1.4.1 Power Regulation	10
1.4.2 Power Requirements	11
1.4.3 Power Sequencing	13
1.4.4 System Power Design	13
1.4.5 PCI Vaux (PCI Auxiliary) Support	14
1.5 Clock Management	14
1.5.1 PCI	14
1.5.2 System Clock Distribution	15
1.6 Other Interfaces	15
1.6.1 JTAG Interface	15
1.6.2 EEPROM Interface	15
1.6.3 GPIO Interface	16
1.7 Hardware Reset	16
1.8 Logic Analyzer Connectivity	17
2. Configurable Options.	19
2.1 Switches	19
2.1.1 DIP Switches	19
2.1.2 Push Button	23
2.2 Shunt Jumpers	24
2.2.1 J6 Shunt Jumper	25
2.2.2 J21 Shunt Jumper	25
2.3 Debug Headers	26
2.3.1 J22 Tsi381 JTAG	27
2.3.2 J23 Logic Analyzer PADS	28
2.4 Connectors	29
2.4.1 J1, J2, J36, J37 Connectors	30
2.4.2 J3 ATX Power Connector	30

2.4.3	P1 x1 PCIe Finger Connector	31
2.5	LEDs	31
3.	Bill of Materials	33

About this Document

This document describes how to test the key features of the Tsi381 using the Tsi381 evaluation board. It can be used in conjunction with the *Tsi381 Evaluation Board Schematics*.

Related Information

- *Tsi381 User Manual*
- *Tsi381 Evaluation Board Schematics*
- *Tsi381 Board Design Guidelines*
- *PCI Express Base Specification (Revision 1.1)*
- *PCI Express CEM Specification (Revision 1.1)*
- *PCI Express-to-PCI/PCI-X Bridge Specification (Revision 1.0)*

Acronyms

Term	Definition
PCIe	PCI Express
SerDes	Serial/De-serializer

Revision History

60E2000_MA001_03, Formal, September 2009

This document was rebranded as IDT. It does not include any technical changes.

60E2000_MA001_02, Formal, September 2007

Added a new section that discusses “**PCI Vaux (PCI Auxiliary) Support**”.

60E2000_MA001_01, Formal, August 2007

This is the first version of the *Tsi382 PCIe-to-PCI Bridge User Manual*.

1. Board Design

Topics discussed include the following:

- “Overview” on page 7
- “PCI Interface” on page 9
- “PCIe Interface” on page 10
- “Power Management” on page 10
- “Clock Management” on page 14
- “Other Interfaces” on page 15
- “Hardware Reset” on page 16
- “Logic Analyzer Connectivity” on page 17

1.1 Overview

The key features of the Tsi381 evaluation board include the following (see also [Figure 1](#)):

- Single x1 lane, 2.5 Gbps PCIe 1.1 compatible riser card (extended height form factor)
- Four PCI slots
- 32-bit PCI bus, 25–66 MHz operation
- PCI power support through system or external supply
- PCIe compliance/debugging test points

Figure 1: Evaluation Board Block Diagram

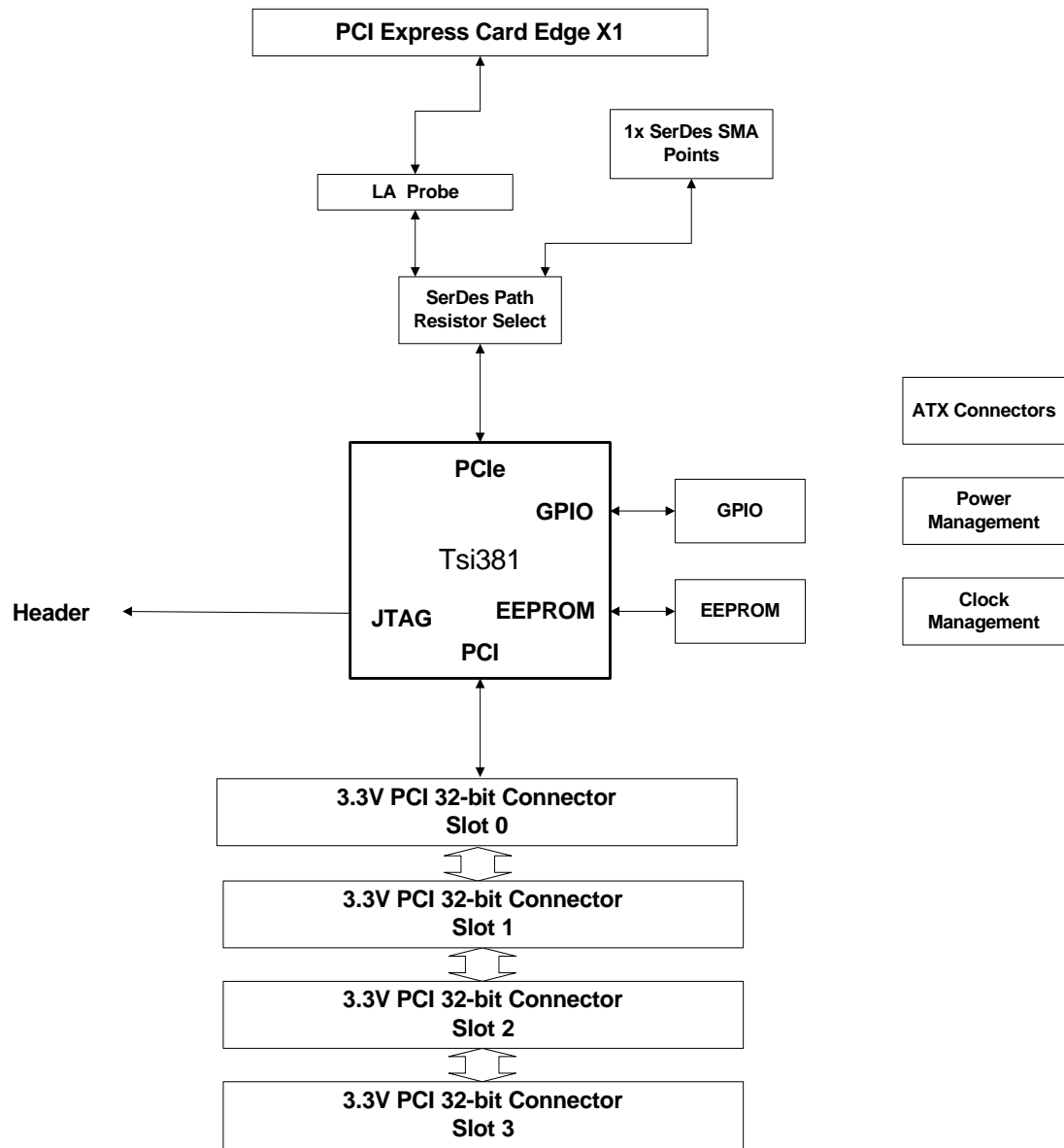

1.2 PCI Interface

1.2.1 Overview

The PCI Interface is implemented on the board with four slots, in which one is an R/A mounted connector on the top of the board. All PCI connectors are compliant with the PCI 3.0 specification. Appropriate clearance is provided such that up to four PCI cards can be inserted for testing while the board is in an open-chassis standard ATX case.

The PCI Interface supports four slots operating at 25, 33, 50, or 66 MHz.

1.2.2 IDSEL Signals

IDSEL signals are connected in the following order:

- Slot 0 – R/A connector top slot: 150 ohms to AD16 (Device 0)
- Slot 1 – 150 ohms to AD17 (Device 1)
- Slot 2 – 150 ohms to AD19 (Device 3)
- Slot 3 – 150 ohms AD18 (Device 2)

1.2.3 Interrupt Signals

The PCI interrupt signals are connected to the slots as shown in the following table.

Table 1: PCI Interrupt Routing

Tsi381	Slot 0	Slot 1	Slot 3	Slot 4
A	A	B	D	C
B	B	C	A	D
C	C	D	B	A
D	D	A	C	B

1.2.4 Pull-up Signals

The following pull-ups are added to the PCI bus, in which a value of 8.2Kohm is used.

Table 2: PCI Pull-up Signals

Signal	Description
PCI_REQ#[0:3]	Bus request
PCI_GNT#[0:3]	Bus grant
PCI_FRAME#	Control signal
PCI_IRDY#, PCI_TRDY#	Control signal

Table 2: PCI Pull-up Signals (Continued)

Signal	Description
PCI_STOP#	Control signal
PCI_SERR#	System error
PCI_PERR#	Parity error
PCI_DEVSEL#	Device select line
PCI_INT#[A:D]	Interrupt line
PCI_PME#	PCI Power Management Event occurred

1.3 PCIe Interface

The Tsi381 evaluation board implements a single lane PCIe Interface. It is designed to connect to a PCIe system with a standard x1 finger connector. The system must provide the REFCLK and PERSTN signals. The PCIe Interface has the following design elements:

- Supports Hot insertion and removal
- Mid-bus logic analyzer pads for PCIe RXD/TXD signal probing
- AC coupling on the TXD lanes
- JTAG TDI - TDO loopback for chain continuity

1.4 Power Management

1.4.1 Power Regulation

The evaluation board's power regulation is implemented as follows:

- Digital 3.3V power supply available from DC/DC regulator or ATX supply
- Digital 1.2V switching regulator
- PCIe supplies filtered using EMI ferrite networks

To support PCI cards, the following additional power resources are included:

- 12V to 5V DC/DC converter
- 12V to 3.3V DC/DC converter
- External power connectors – ATX 20-pin connector for supplying all power from an ATX power supply

1.4.2 Power Requirements

The power requirements and implementation for the Tsi381 is as follows.

Table 3: Tsi381 Power Requirements

Supply Name	Symbol	Supplied Source
Device Core	1.2V_384	DC/DC switching regulator w/Enable pin
PCIe 1.2V Core	1.2V_A_384	Passive Filter
PCI 3.3V supply	3.3V_384	Power switch w optional Ferrite filter to reduce EMI/noise from PCI environment
PCIe 3.3V supply	3.3V_A_384	Passive Filter

The target power draw of the Tsi381 is a maximum of 1W, all supplies combined. The supplies to the Tsi381 are controlled during ramp up using enable pins on regulators and switches.

1.4.2.1 PCIe

The PCIe CEM Specification 1.1 defines power limits on PCIe slots according to the number of lanes available on a card. Power rules regarding x1 PCIe slots are a maximum of 25W slot. Current limits are included in [Table 4](#).

Table 4: PCIe Connector Current Limits

Rail	Current
3.3V	3A
12V	2.1A

The usage of the 12V supply provides access to the full 25W available from the system to the board. The PCIe pinout design includes more 12V power pins as it allows more power-per-pin capability. The evaluation board regulates all power from the 12V system rail; however, 3.3V from the system remains unused.

1.4.2.2 PCI

The PCISIG defines the power rules regarding PCI cards as a maximum of 25 Watts per card (All power rails combined power draw). The individual current limits on voltage rails are included in [Table 5](#).

Table 5: PCI Connector Current Limits

Rail	Current
3.3V	7.6a
5V	5a
-12V	100ma
12V	500ma

It is not possible to provide the full power required to the PCI bus without violating the specification while drawing power from only a x1 PCIe system. Up to 23W not including regulator efficiency losses can be made available. The evaluation board provides the power requirements in one of two ways depending on the application:

- PCIe system power
- ATX System connector

The following conditions summarize the power available for a single PCI card without external supply. An efficiency of 85% is taken into account for switching regulators. These limits can be exceeded in cases where the system can provide more than the suggested limit, which is usually only implemented in hot swap systems.

Table 6: PCI Connector Current Limit with No External Supply

Rail	Supplying Topology	Current (Maximum)
3.3V	12V to 3.3V regulator	6A
12V	12V directly	500mA
-12V	N/A	N/A
5V	12V to 5V regulator	4A

For additional slots, or in cases where the system cannot supply enough power, a separate ATX power connector is used to power the card. The evaluation board senses the presence of this supply, and disables the slave PCIe slot power. For the case of a separate external ATX supply, all four slots are provided with the required power.

1.4.3 Power Sequencing

On power-up, the board's power sequence is as follows:

1. 1.2V powered on
 2. PCI I/O slot power and pull-ups, and Tsi381 3.3V
- 12V/-12V/5V PCI are not sequence controlled.

1.4.4 System Power Design

Figure 2 illustrates the power distribution for the riser card. The following list is a functional summary of the power design:

1. Sequencing control over the following rails:
 - 3.3V PCI
 - 3.3V Tsi381 I/O/PCIe A_{VDD}
 - 1.2V Tsi381 Core/PCIe V_{DD}
2. ATX 20-pin connector override, which disables all power draw from the PCIe system.

Figure 2: System Power Distribution

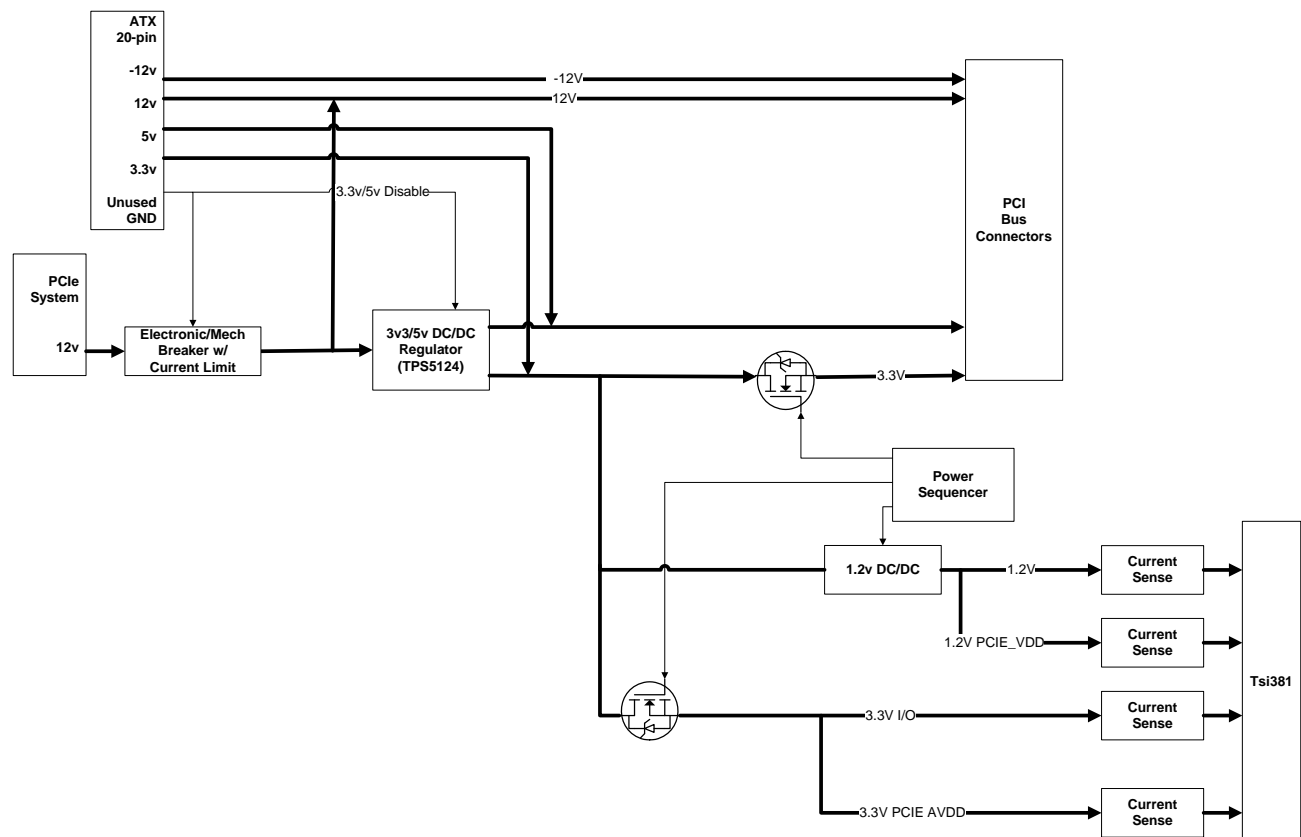

1.4.5 PCI Vaux (PCI Auxiliary) Support

PCI connectors are provided with a 3.3V supply to the vaux pins only during operation. There is no support for this power supply in standby mode. This feature is not documented in the Tsi381 evaluation board schematic.

1.5 Clock Management

The Tsi381 requires up to two input clocks to operate:

- 25–66 MHz clock for PCI
- 100-MHz reference clock for PCIe

The PCI and PCIe input clocks are briefly discussed.

1.5.1 PCI

The evaluation board supports master and slave clocking for PCI.

- Master – When in master mode, the Tsi381 generates the required PCI clock for all slots.
- Slave – When in slave mode, an on-board selectable 25–66 MHz clock generator is used.

On-board resistor muxes are used to multiplex either Tsi381's PCI clock or the external clock generator.

1.5.1.1 PCIe

For PCIe clocking, a 100-MHz differential HCSL clock source is required. The clock source is available in two forms:

- Edge connector clock source – This clock source synchronizes the system SerDes with the Tsi381.
- On-board 100-MHz reference – This clock source can separate the clock domains between the bridge and the root complex.

The two PCIe clock sources are multiplexed with an analog multiplexer to select between the system clock or on-board clock (see [Figure 3](#)).

1.5.2 System Clock Distribution

The following figure shows the distribution of the system clock on the Tsi381 evaluation board.

Figure 3: System Clock Distribution

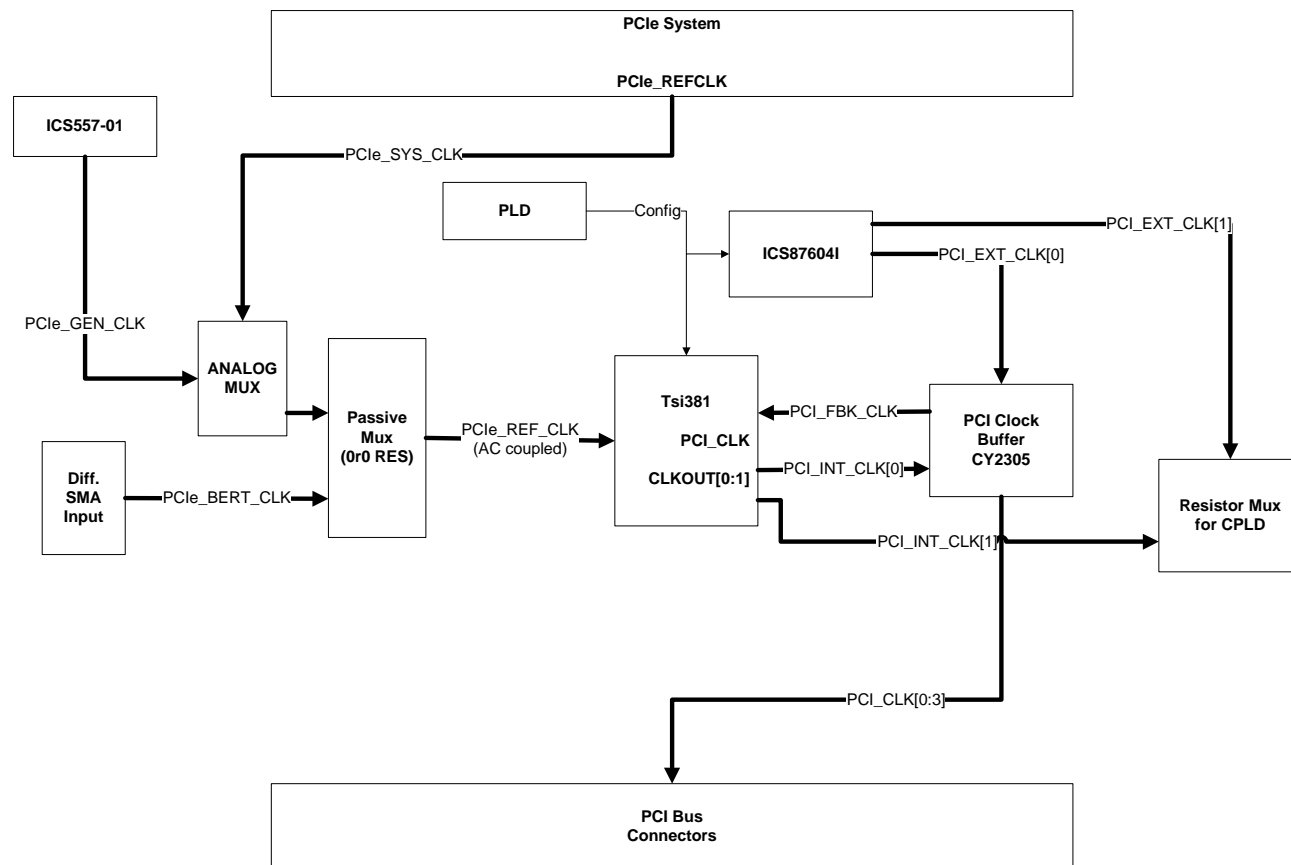

1.6 Other Interfaces

1.6.1 JTAG Interface

To support debug and testing of device, JTAG access to the Tsi381 is available using a standard JTAG header for Wiggler connection.



For more information about accessing the Tsi381 using JTAG, see the *JTAG Register Access Software Application Note*.

1.6.2 EEPROM Interface

A single EEPROM device socket is available for programming the Tsi381's registers during startup. The socket is in an 8-pin DIP format.

1.6.3 GPIO Interface

The GPIO Interface is comprised of the following:

- On-board LEDs on GPIO lines
- Available 100mil Header to send/receive external 3.3V level signals

The following list outlines the connections to GPIO:

- External I/O header:
 - J7.1: NC
 - J7.2: GPIO0
 - J7.3: GPIO1
 - J7.4: GPIO2
 - J7.5: GPIO3
 - J7.6: Connected to ground
- LEDs:
 - D11: GPIO0, active led when driven low
 - D1: GPIO1, active led when driven low
 - D13: GPIO2, active led when driven low
 - D12: GPIO3, active led when driven low

1.7 Hardware Reset

The following figure shows the reset options of the Tsi381 evaluation board.

Figure 4: Board Reset

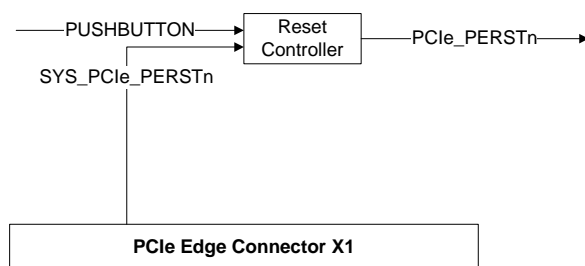

Three levels of reset are available:

- Cold reset – This reset is applied during power up. System (card edge) PCIe_PERSTn is muxed with the board's reset controller.
- Warm reset – This reset is activated by a push-button reset on the board.
- Hot reset – This reset is activated by the in-band message sent by the root complex. No supporting hardware is necessary.



For more information on cold, warm, and hot reset levels, see the “Resets, Clocking, and Initialization Options” chapter in the *Tsi381 User Manual*.

1.8 Logic Analyzer Connectivity

The serial buses have Midbus pads (TMS818 probe) for visibility of SerDes lines using a pre-processor. Each probing pad provides access to the RX and TX segments of a x1 link.

To access the PCI bus, a Nexus PCI interposer card can be used with Tektronix mictor cables. The card can be plugged into any PCI edge slot, or in-line with the device under test.

2. Configurable Options

Topics discussed include the following:

- “Switches” on page 19
- “Shunt Jumpers” on page 24
- “Debug Headers” on page 26
- “Connectors” on page 29
- “LEDs” on page 31

2.1 Switches

2.1.1 DIP Switches

Switches S1 to S6 combine four, small slide switches identified with numbers 1 to 4 (see [Table 7](#) for individual switch definition).

Figure 5: DIP Switch Package/Individual Switch Position

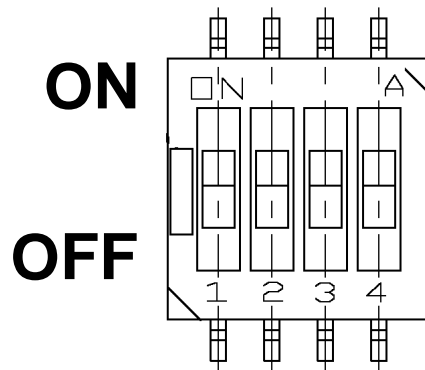
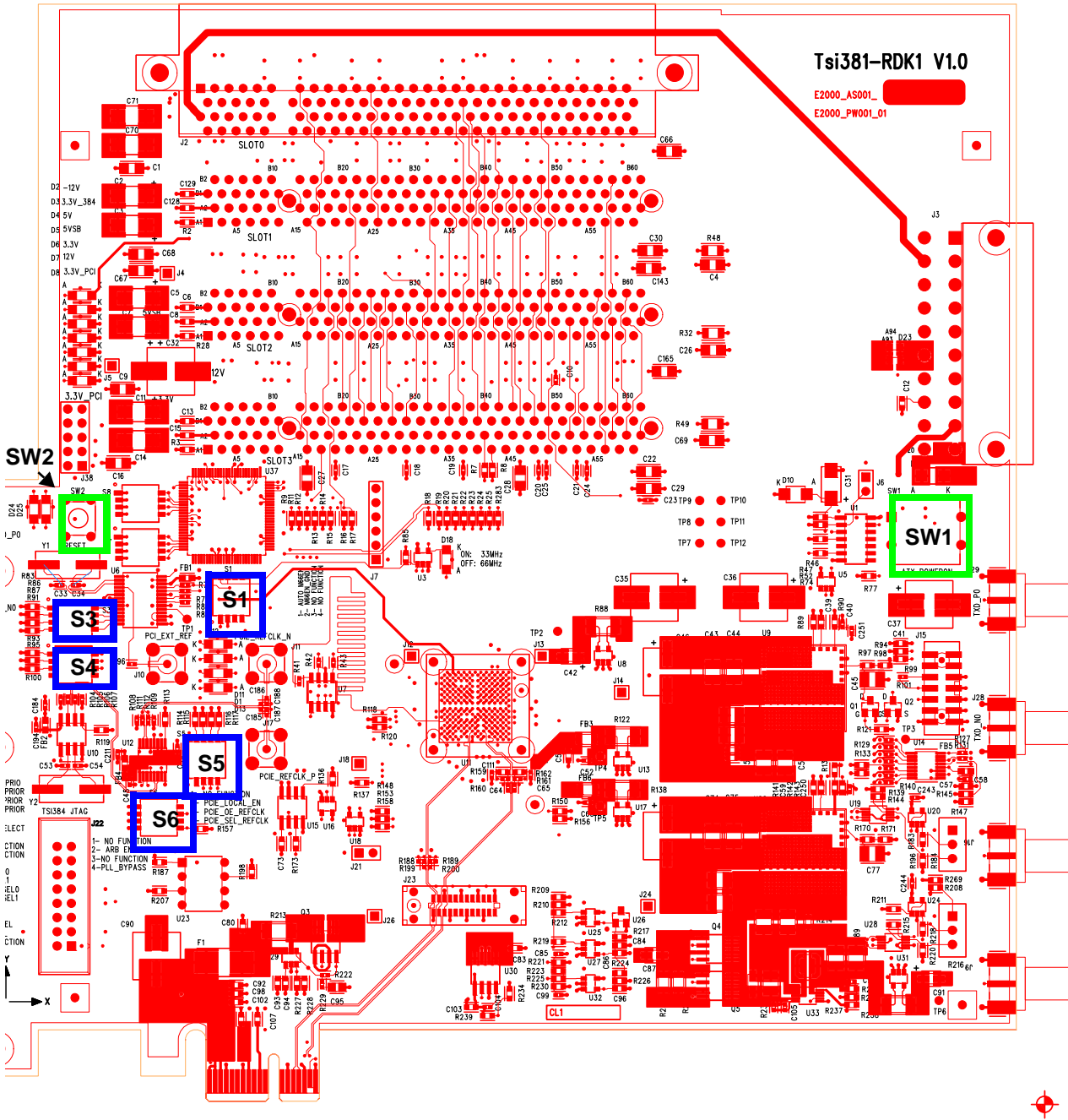

Figure 6: Switch Locations



Switch S1 is used to manually set PCI bus modes.

Table 7: S1 Settings

Switch Number	Description	Default Setting	On/Off Setting
1	M66EN	ON	ON = Connects M66EN to all cards OFF = Forces M66EN high if S1.2 OFF
2	M66EN	OFF	ON = Forces M66EN to GND OFF = Disables forcing M66EN to GND

Switches S3 and S4 are used to set the PCI bus external clock frequency. By default the PCI bus clock source is the Tsi381. The external clock can only be connected to the PCI bus by replacing resistors on the board. When an external clock source is used, an on-board PLL is used to set the proper bus clock frequency. [Table 8](#) contains the clock frequency settings for S3.

Table 8: S3 Settings

Switch Number	Description	Default Setting	On/Off Setting
1	DIV_SEL0	OFF	[FBDIV_SEL1, FBDIV_SEL0, DIV_SEL1, DIV_SEL0] ON = 1 OFF = 0 0,0,0,0 = x 4 0,0,0,1 = x 3 0,0,1,0 = x 2 0,0,1,1 = x 1 0,1,0,0 = x 5.33 0,1,0,1 = x 4 0,1,1,0 = x 2.667 0,1,1,1 = x 1.33 1,0,0,0 = x 6.667 1,0,0,1 = x 5 1,0,1,0 = x 3.33 1,0,1,1 = x 1.67 1,1,0,0 = x 8 1,1,0,1 = x 6 1,1,1,0 = x 4 1,1,1,1 = x 2
2	DIV_SEL1	OFF	
3	FBDIV_SEL0	OFF	
4	FBDIV_SEL1	OFF	

Switch S4 controls the external clock PLL.

Table 9: S4 Settings

Switch Number	Description	Default Setting	On/Off Setting
1	PLL Reset	ON	ON = PLL in reset. PLL clock outputs are low. OFF = PLL is active and clock outputs are enabled.
2	XTAL select	OFF	ON = Clock source for PLL is reference clock from connector J10 OFF = Clock source for PLL is a 25-MHz oscillator.
3	PLL select	OFF	ON = PLL is bypassed. OFF = PLL is enabled. External clock source is multiplied as per S3 setting
4	No function	-	-

Switch S5 controls the PCIe clock multiplexer and the on-board PCIe reference clock PLL.

Table 10: S5 Settings

Switch Number	Description	Default Setting	On/Off Setting
1	No Function	-	-
2	PCIe on-board PLL enable	ON	ON = On-board PCIe reference clock PLL is disabled. OFF = On-board PCIe reference clock PLL is enabled.
3	PCIe clock multiplexer enable	OFF	ON = On-board PCIe clock multiplexer is disabled. OFF = On-board PCIe clock multiplexer is enabled.
4	PCIe clock source select	OFF	ON = On-board PCIe reference clock is used. OFF = System PCIe reference clock is used.

Switch S6 configures Tsi381's power-up options.

Table 11: S6 Settings

Switch Number	Description	Default Setting	On/Off Setting
1	No function	-	-
2	Internal arbiter option	ON	ON = Internal arbiter is enabled OFF = Internal arbiter is disabled
3	No function	-	-
4	PCI PLL bypass	ON	ON = PLL is enabled OFF = PLL is bypassed

2.1.2 Push Button

SW1 is used to turn the ATX power supply ON. This switch is used only when the Tsi381 evaluation board is powered up with a stand-alone ATX power supply.

SW2 is used to reset the evaluation board. When pushing the reset button, the board is reset the same way a PCIe system reset would reset the board.

2.2 Shunt Jumpers

Shunt jumpers control special features on the evaluation board (see Figure 7). These jumpers are explained in the following sub-sections.

Figure 7: Shunt Jumper Locations

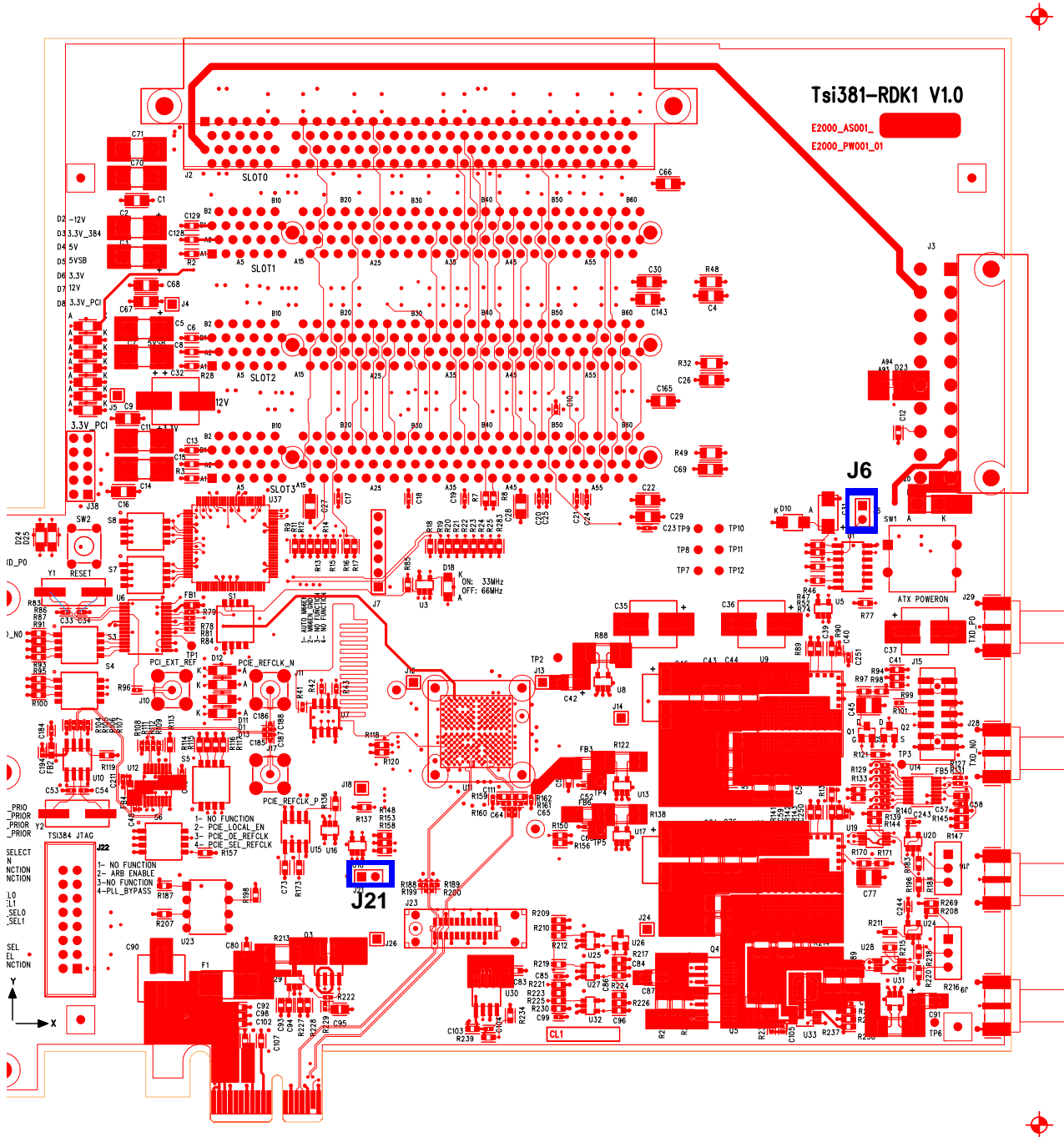

2.2.1 J6 Shunt Jumper

J6 is used to bypass the On/Off push button to enable the ATX power supply.

Table 12: J6 Shunt Jumper Setting

Jumper Setting	Default Setting	Function
Installed	Removed	Forces ATX power supply ON.
Removed		Normal operation, ATX power supply is turned On/OFF from push button.

2.2.2 J21 Shunt Jumper

J21 is used to force the Tsi381 into a special debug mode. The default setting for this jumper is ON.

2.3 Debug Headers

Debug headers are used to connect to signals on the evaluation board. This section provides header pinouts.

Figure 8: Debug Header Locations

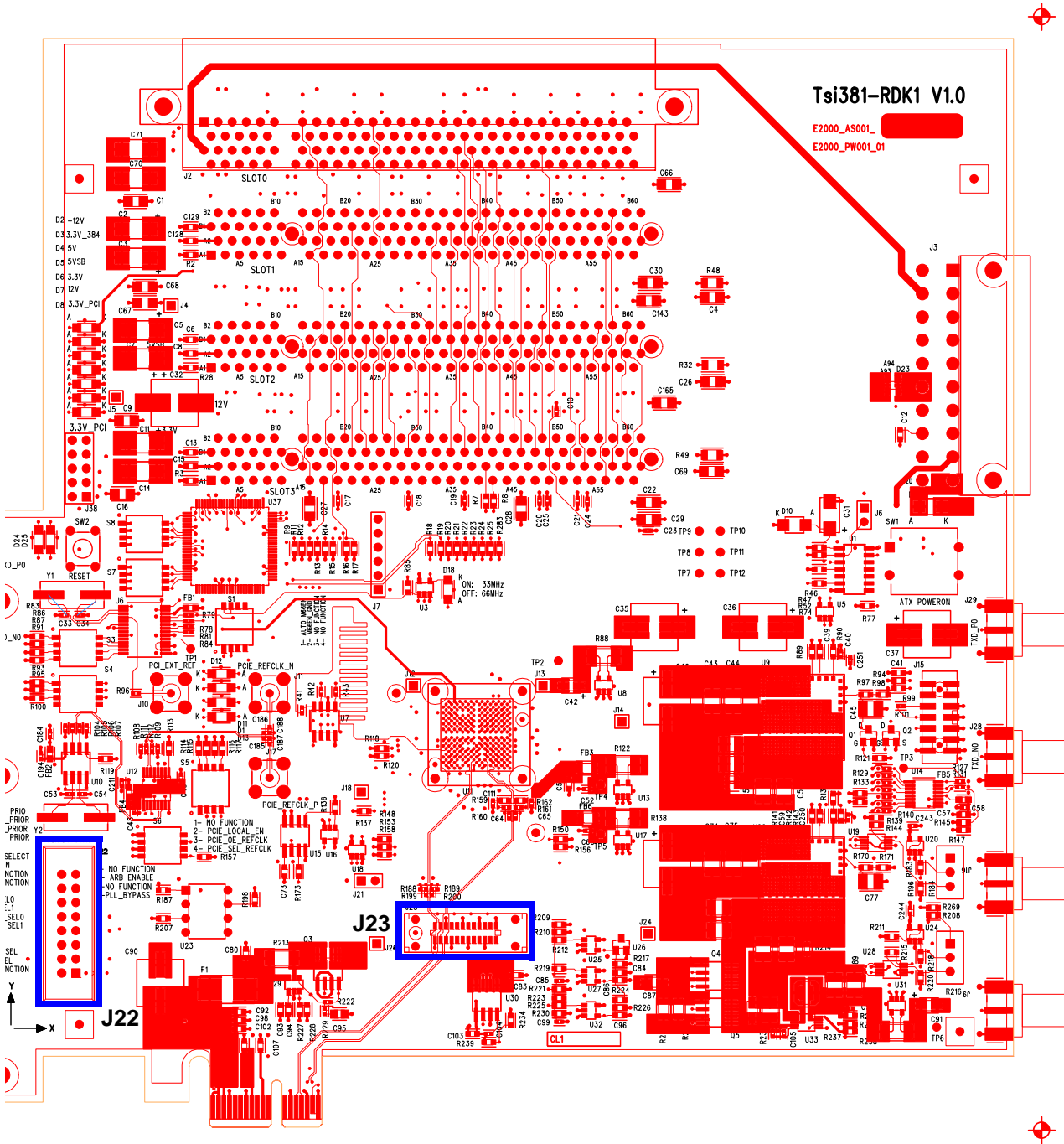

2.3.1 J22 Tsi381 JTAG

Table 13: J22 Pin Assignment

Pin Number	Signal Assignment	Pin Location
1	TDO	<p style="text-align: center;">J22</p>
2	NC	
3	TDI	
4	3.3V	
5	NC	
6	3.3V	
7	TCK	
8	NC	
9	TMS	
10	NC	
11	NC	
12	GND	
13	NC	
14	NC	
15	NC	
16	GND	

2.3.2 J23 Logic Analyzer PADS

Table 14: J23 Pin Assignment

Pin Number	Signal Assignment	Pin Location
1	PCIE_RXD_EDG_P0	
2	GND	
3	PCIE_RXD_EDG_N0	
4	PCIE_TXD_EDG_P0	
5	GND	
6	PCIE_TXD_EDG_N0	
7	N/C	
8	GND	
9	N/C	
10	N/C	
11	GND	
12	N/C	
13	N/C	
14	GND	
15	N/C	
16	N/C	
17	GND	
18	N/C	
19	N/C	
20	GND	
21	N/C	
22	N/C	
23	GND	
24	N/C	

2.4 Connectors

Figure 9: Board Connector Locations

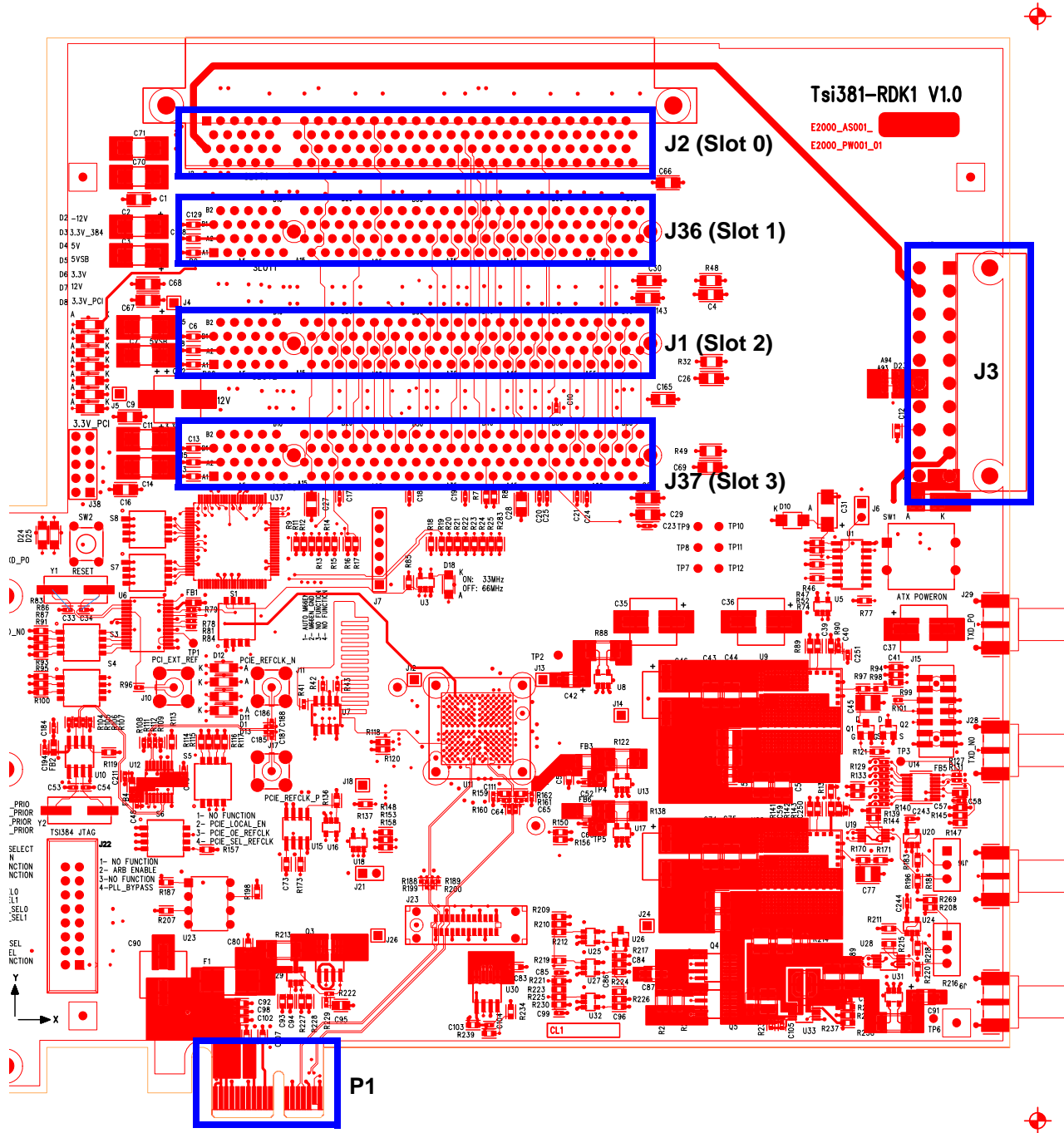

2.4.1 J1, J2, J36, J37 Connectors

These connectors are used to connect a plug-in card to the Tsi381's PCI Interface. The connectors' pin assignments are as per the PCI standard for 32-bit connectors.

2.4.2 J3 ATX Power Connector

A standard ATX power supply can be used to power up the board when used stand alone (not plugged into a PCIe system).

Table 15: J3 Pin Assignment

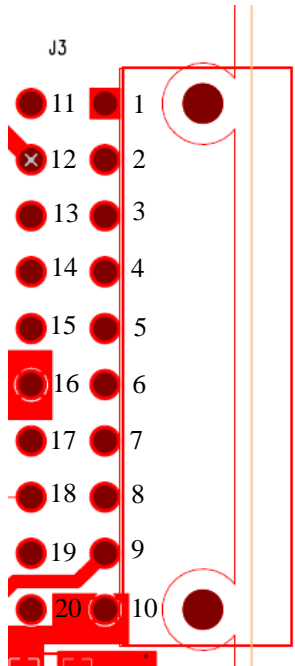
Pin Number	Signal Assignment	J3 Pin Location
1	3.3V	
2	3.3V	
3	GND	
4	5V	
5	GND	
6	5V	
7	GND	
8	N.C.	
9	5VSB	
10	12V	
11	3.3V	
12	-12V	
13	GND	
14	GND	
15	GND	
16	GND	
17	GND	
18	N.C.	
19	5V	
20	5V	

2.4.3 P1 x1 PCIe Finger Connector

The pin assignment for the finger connector is as per the PCIe standard. Note that the JTAG signals TDI and TDO are connected together on the board.

2.5 LEDs

Figure 10: LED Locations

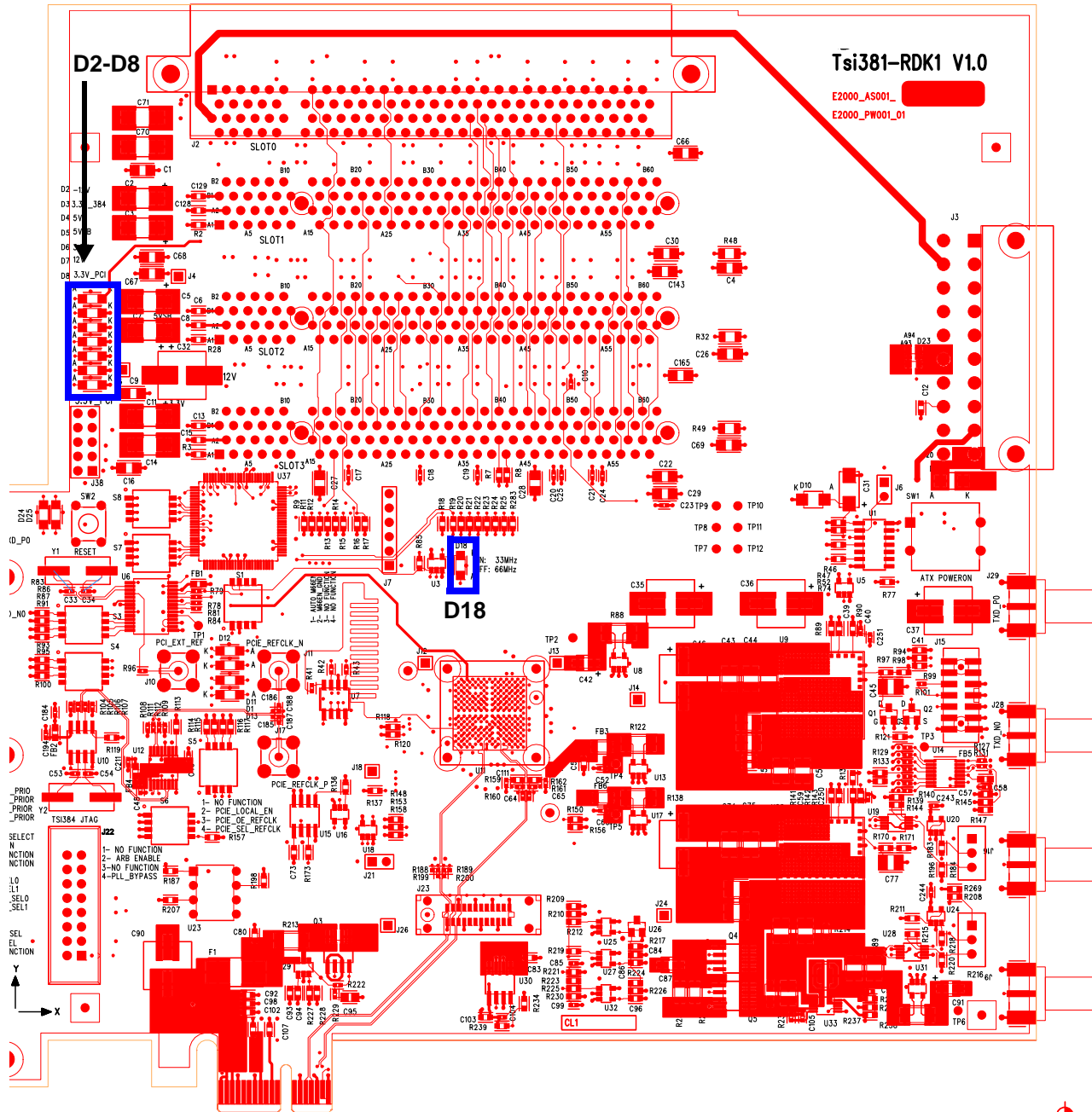

3. Bill of Materials

The bill of materials (BOM) for the Tsi381 evaluation board is listed in the following table.

Table 16: Bill of Materials

Qty.	Reference Designator	Part Number ^a	Part Number (PB free)	Manufacturer	Package Type	Description
1	AP_U1	115-13-308-41-001	115-43-308-41-001	MILL-MAX	115-13-308-41-001	DUAL-IN-LINE SOCKET, 0.1IN, 8PIN
16	C1,C4,C9, C16, C22, C26-30, C66-69, C143,C165	1206ZD106KAT2A	1206ZD106KAT2A	AVX	CAPC1206	X5R CER SMT, 10UF, 10%, 10V, 1206
9	C2-3, C5, C7, C11, C14, C31, C70-71	TAJC476K016R	TAJC476K016R	AVX	CAPT6032-28	TANT SMT, 47UF, 10%, 16V, 6032-28
29	C6,C8, C12-13, C15, C39, C59, C73, C80, C92-94, C96, C98, C102, C106-107, C111-113, C116, C128-129, C172-173, C234, C240-242	06033D104KAT2A	06033D104KAT2A	AVX	CAPC0603	X5R CER SMT, 0.1UF, 10%, 25V, 0603
5	C10, C62, C110, C140, C162	0402ZC103KAT2A	0402ZC103KAT2A	AVX	CAPC0402	X7R CER SMT, 0.01UF, 10%, 10V, 0402
113	C17-21, C23-25, C38, C48-49, C52, C60-61, C63-65, C72,C105,C108-109, C114-115, C117-127, C130-139,C141-142, C144-161,C163-164, C166-171,C175-177, C179,C182-186, C189-198,C200-203, C206-207, C211, C220-221,C226-228, C233, C252-260	0402ZD104KAT2A	0402ZD104KAT2A	AVX	CAPC0402	X5R CER SMT, 0.1UF, 10%, 10V, 0402
7	C32, C35-37, C46, C76, C90	EEVFC1E101P	EEEFC1E101P	PANASONIC	CAPAE95W62H	ALUM ELEC SMT, 100UF, 20%, 25V
4	C33-34, C53-54	04025A180JAT2A	04025A180JAT2A	AVX	CAPC0402	NP0 CER SMT, 18PF, 5%, 16V, 0402
4	C42, C87, C91, C100	TAJA106K016R	TAJA106K016R	AVX	CAPT3216-18	TANT SMT, 10UF, 10%, 16V, 3216-18
6	C43-44, C74-75, C89, C101	ECJ-4YB1E226M	ECJ-4YB1E226M	PANASONIC	CAPC1210	X5R CER SMT, 22UF, 20%, 25V, 1210
2	C45,C77	12105C224KAT2A	12105C224KAT2A	AVX	CAPC1210	X7R CER SMT, 0.22UF, 10%, 50V, CAPC1210
8	C47,C51, C55-56, C78-79, C81-82	12106D107MAT2A	12106D107MAT2A	AVX	CAPC1210	X5R CER SMT, 100UF, 20%, 6.3V, 1210

Table 16: Bill of Materials (Continued)

Qty.	Reference Designator	Part Number ^a	Part Number (PB free)	Manufacturer	Package Type	Description
12	C50,C178, C181, C199, C212, C217-218, 222-223, C225, C231-232	0603ZD105KAT2A	0603ZD105KAT2A	AVX	CAPC0603	X5R CER SMT, 1UF, 10%, 10V,0603
2	C85,C99	ECJ-0EB1C104K		PANASONIC	CAPC0402	X5R CER SMT, 100NF, 10%,16V,CAPC0402
1	C95	ECJ-2VB1H103K		PANASONIC	CAPC0805	X7R CER SMT, 10NF, 10%, 50V,0805CAPC0805
1	C97	0402ZC103JAT2A	0402ZC103JAT2A	AVX	CAPC0402	X7R CER SMT, 0.01UF, 5%, 10V,0402
1	C174	ECJ-1VB0J106M	ECJ-1VB0J106M	PANASONIC	CAPC0603	X5R CER SMT, 10UF, 20%, 6.3V,0603
2	C250-251	0402YC101KAT2A	0402YC101KAT2A	AVX	CAPC0402	X7R CER SMT, 100PF, 10%,16V,0402
4	D1,D11-13	HSMG-C150	HSMG-C150	AGILENT	LED_HSMG-C150	GREEN LED, UNTINTED, DIFFUSED
8	D2-8,D18	HSMG-C150	HSMG-C150	AGILENT	LED_HSMG-C150	GREEN LED, UNTINTED, DIFFUSED
1	D9		B220A-13-F	DIODES INC.	DIOSMA	2A SCHOTTKY DIODE RECTIFIER0.5VF
1	D10	S1B	S1B	FAIRCHILD	DIOSMA	GENERAL PURPOSE RECTIFIER
1	D23	LCDA15C-1.TC		SEMTECH	SOT143	TVSDIODEARRAY
1	F1	R154 010	R154 010	LITTLEFUSE	FUSE_154	SMT FUSE BLOCK FOR FAST 10A FUSE (INCLUDED)
5	FB1-2,FB4, FB7-8	BLM18AG601SN1D	BLM18AG601SN1D	MURATA	FB_0603	SMT FERRITE BEAD, 60OHMS, 25%, 0.2AMPS, 0603
2	FB3,FB6	BLM31PG500SN1B	BLM31PG500SN1L	MURATA	FB_1206	SMT FERRITE BEAD, 50OHMS, 25%, 3AMPS, 1206
3	J1,J36-37	145154-4	5145154-4	AMP	145154-4-60	PCI MOTHERBOARD, 32BIT,3.3V,THRU
1	J2	RBB60DHAS-S793	RBB60DHAS-S793	SULLINS	RBB60DHAS-S793	PCI 3.3V, 32BIT, RIGHT ANGLE, 100MIL ROW-TO-ROW
1	J3	39-30-0200	39-30-0200	MOLEX	39-30-0200	R/A ATX PWR JACK, 0.165" PITCH, MINI FIT W/PEGS
2	J6,J21	69190-102	69190-102HLF	FCI	69190-102H	2X1,0.1INHDR
1	J7	54101-T06-06	54101-F06-06	FCI	54101-T06-06	1X6,0.1INHDR

Table 16: Bill of Materials (Continued)

Qty.	Reference Designator	Part Number ^a	Part Number (PB free)	Manufacturer	Package Type	Description
1	J22	5103309-3	5103309-3	TYCO	5103309-3	2X8, 0.1IN HDR,CENTER/DUAL POLARIZING BAR SHROUD
1	L1		LPS4018-222MLB	COILCRAFT	LPS4018	2.2UH SMT POWER INDUCTOR, 2.5A ISAT,.070ESR
1	P1			PCISIG	X1PCIE_FINGER_CONNECTOR	PCIE 1X FINGER CONNECTOR
2	Q1-2	2N7002	2N7002	FAIRCHILD	SOT23-3-GSD	N-CHANNELMOSFET
1	Q3	FDS6990A		FAIRCHILD SEMICONDUCTOR	SOIC127P6-8	2N-CHMOSFET30V7.5A
2	Q4-5	IRF8915	IRF8915PBF	INTERNATIONAL RECTIFIER	SOIC127P6-8	2N-CHMOSFET20V8.9A
4	R1,R6, R244,R272	ERJ-3GEYJ151V	ERJ-3GEYJ151V	PANASONIC	RESC0603	RES SMT, 150 OHM, 0.1W, 5%, 0603
29	R2-5,R7-8, R26-31, R50-51, R77,R217, R227, R245-253, R257-258, R267	ERJ-3GEYJ512V	ERJ-3GEYJ512V	PANASONIC	RESC0603	RES SMT, 5.1K OHM, 0.1W,5%, 0603
5	R9-12,R209	ERJ-3GEYJ242V	ERJ-3GEYJ242V	PANASONIC	RESC0603	RES SMT, 2.4K OHM, 0.1W,5%, 0603
18	R13,R52, R83, R86-87, R91, R93, R95, R100, R114-117, R136, R172-173, R259, R264	ERJ-3EKF1001V	ERJ-3EKF1001V	PANASONIC	RESC0603	RES SMT, 1K OHM, 0.1W, 1%, 0603
26	R14-25, R53,R85, R118, R120, R137, R157, R187, R198, R207, R226, R241-242, R256, R283	ERJ-3GEYJ822V	ERJ-3GEYJ822V	PANASONIC	RESC0603	RES SMT, 8.2K OHM, 0.1W,5%, 0603
3	R32, R48-49	ERJ-8GEY0R00V	ERJ-8GEY0R00V	PANASONIC	RESC1206	RES SMT, 0 OHM, 0.25W, 5%, 1206
8	R33-36, R260, R263, R266, R282	ERJ-3EKF3920V	ERJ-3EKF3920V	PANASONIC	RESC0603	RES SMT, 392 OHM, 0.1W, 1%, 0603
5	R37, R40, R149, R199-200	ERJ-2GE0R00X	ERJ-2GE0R00X	PANASONIC	RESC0402	RES SMT, 0 OHM, 0.063W, 5%, 0402
5	R41-45	ERJ-2GEJ120X	ERJ-2GEJ120X	PANASONIC	RESC0402	RES SMT, 12 OHM, 0.0625W,5%, 0402
4	R46-47, R210, R274	ERJ-3GEYJ103V	ERJ-3GEYJ103V	PANASONIC	RESC0603	RES SMT, 10K OHM, 0.1W, 5%, 0603

Table 16: Bill of Materials (Continued)

Qty.	Reference Designator	Part Number ^a	Part Number (PB free)	Manufacturer	Package Type	Description
4	R54-57	ERJ-3EKF1330V	ERJ-3EKF1330V	PANASONIC	RESC0603	RES SMT, 133 OHM,.1W, 1%,0603
3	R74, R214, R265	ERJ-3GEYJ201V	ERJ-3GEYJ201V	PANASONIC	RESC0603	RES SMT, 200 OHM, 0.1W, 5%,0603
2	R75,R236		ERJ-2GEJ100X	PANASONIC	RESC0402	RES SMT, 10 OHM, 0.0625W,5%,0402
11	R78-79, R81, R84, R105-106, R111-112, R284-285, R296		ERJ-2RKF33R2X	PANASONIC	RESC0402	RES SMT, 33.2 OHM, 0.0625W,1%,0402
3	R88, R213, R238		WSL2010R0150FE A	VISHAY	RESC2010	RES SMT, 0.015 OHM, 0.5W, 1%, 2010, CURRENTSENSE
2	R89,R224	ERJ-3EKF1502V	ERJ-3EKF1502V	PANASONIC	RESC0603	RES SMT, 15.0K OHM, 0.1W,1%,0603
1	R90	ERJ-3EKF1372V	ERJ-3EKF1372V	PANASONIC	RESC0603	RES SMT, 13.7K OHM, 0.1W,1%,0603
4	R104, R107-109	ERJ-2RKF49R9X	ERJ-2RKF49R9X	PANASONIC	RESC0402	RES SMT, 49.9 OHM, 0.063W,1%,0402
5	R113,R119, R124, R128, R262		ERJ-3EKF4750V	PANASONIC	RESC0603	RES SMT, 475 OHM, 0.1W, 1%,0603
1	R121	ERJ-3GEYJ473V	ERJ-3GEYJ473V	PANASONIC	RESC0603	RES SMT, 47K OHM, 0.1W, 5%,0603
2	R122,R138		WSL2010R1000FE A	VISHAY	RESC2010	RES SMT, 0.100 OHM, 0.5W, 1%, 2010, CURRENTSENSE
1	R132	ERJ-3EKF7151V	ERJ-3EKF7151V	PANASONIC	RESC0603	RES SMT, 7.15K OHM, 0.1W,1%,0603
1	R142	ERJ-3EKF1502V	ERJ-3EKF1502V	PANASONIC	RESC0603	RES SMT, 15.0K OHM, 0.1W,1%,0603
7	R153, R156, R158, R288, R293-295	ERJ-3GEYJ202V	ERJ-3GEYJ202V	PANASONIC	RESC0603	RES SMT, 2K OHM, 0.1W, 5%,0603
2	R221,R230	ERJ-3EKF1103V	ERJ-3EKF1103V	PANASONIC	RESC0603	RES SMT, 110K OHM, 0.1W,1%,0603
2	R222,R229	ERJ-2RKF1000X	ERJ-2RKF1000X	PANASONIC	RESC0402	RES SMT, 100 OHM,.06W, 1%,0402
2	R223,R225	9C06031A0R00JLH FT	RC0603JR-070R	YAGEO	RESC0603	RES SMT, 0 OHM, 0.1W, 5%,0603
1	R228	ERJ-3GEYJ223V	ERJ-3GEYJ223V	PANASONIC	RESC0603	RES SMT, 22K OHM, 0.1W, 5%,0603
2	R231-232	ERJ-8GEY0R00V	ERJ-8GEY0R00V	PANASONIC	RESC1206	RES SMT, 0 OHM, 0.25W, 5%,1206
1	R233	ERJ-3GEYJ512V	ERJ-3GEYJ512V	PANASONIC	RESC0603	RES SMT, 5.1K OHM, 0.1W,5%,0603

Table 16: Bill of Materials (Continued)

Qty.	Reference Designator	Part Number ^a	Part Number (PB free)	Manufacturer	Package Type	Description
1	R235		ERJ-3EKF1002V	PANASONIC	RESC0603	RES SMT, 10K OHM, 0.1W, 1%, 0603
1	R237	9C06031A0R00JLH FT	RC0603JR-070R	YAGEO	RESC0603	RES SMT, 0 OHM, 0.1W, 5%, 0603
1	R261	ERJ-3GEYJ471V	ERJ-3GEYJ471V	PANASONIC	RESC0603	RES SMT, 470 OHM, 0.1W, 5% 0603
1	R273	ERJ-3GEYJ563V	ERJ-3GEYJ563V	PANASONIC	RESC0603	RES SMT, 56K OHM, 0.1W, 5%, 0603
5	S1,S3-6	1-1435790-4	1571983-4	TYCO	SW_1-1435790-4	DIPSWITCH,4SWITCHES
1	SW1	PTS125SM43	PTS125SM43-LFS	ITT/CANNON	PTS125	PUSHBUTTON SWITCH, 0.5X0.5
1	SW2	EVQPAC07K	EVQPAC07K	PANASONIC	SW_EVQPAC07K	PUSHBUTTONSWITCH
12	TP1-12				TESTPOINT	
1	U1	MM74HC74AM	MM74HC74AMX_N L	FAIRCHILD	SOIC127P6-14	DUAL D-TYPE FLIP-FLOP WITH PRESET AND CLEAR
3	U3,U16,U18	NC7SZ08M5X	NC7SZ08M5X	FAIRCHILD	SOT23-5	TINY LOGIC 2-INPUT AND GATE 1.65VTO5.5V
1	U5	SN74LVC1G14DBV T	SN74LVC1G14DBV T	TI	SOT23-5	SINGLE SCHMITT-TRIGGER INVERTER
1	U6	ICS87604AGI	ICS87604AGILF	IDT	TSOP65P81-28	LOW VOLTAGE, LOW SKEW 1:4 PCI/PCI-X ZERO DELAY CLOCK GENERATOR
1	U7		CY2305SXC-1H	CYPRESS	SOIC127P600-8	1-TO-4 3.3V ZERO DELAY CLOCKBUFFER
4	U8, U13, U17,U31	MAX4372FEUK-T	MAX4372FEUK	MAXIM	SOT23-5	VOLTAGE OUTPUT HIGH-SIDE CURRENT SENSE AMPLIFIER WITH 50V/V GAIN
2	U9,U22		LTM4600EV_PBF	LINEAR	LTM4600EV_PBF	10A 4.5V TO 20V INPUT, 0.6V TO 5.0V OUTPUT SWITCHINGREGULATOR
1	U10	ICS557M-01	ICS557M-01LF	IDT	SOIC127P6-8	100MHZ, HCSL OUT, 3.3V, 25MHZ INPUT (SUPPORTSPCIE)
1	U11	Tsi381	Tsi381	IDT (formerly Tundra)	BGA100P12X12-14 4	1X PCIE TO PCI 66MHZ HOSTBRIDGE
1	U12	ICS557G-08	ICS557G-08LF	IDT	TSSOP65P64-16	2:1 MULTIPLEXER CHIP FORPCIEXPRESS
1	U15	TL7702BCD	TL7702BCD	TI	SOIC127P6-8	POR GENERATOR, 3.5-18VVCC
1	U26	LM4050_IM3-2.5	LM4050AEM3-2.5	MAXIM	SOT23-3	SHUNT REFERENCE VOLTAGE2.5V

Table 16: Bill of Materials (Continued)

Qty.	Reference Designator	Part Number ^a	Part Number (PB free)	Manufacturer	Package Type	Description
1	U29	LTC4210-2CS6	LTC4210-2CS6#TR MPBF	LINEAR	TSOT23-6	HOTSWAPCONTROLLER
1	U32	LMC7221BIM5	LMC7221BIM5_NO PB	NATIONAL	SOT23-5	CMOS COMPARATOR, R-TO-R INPUT, OPEN DRAINOUTPUT
1	U33	-	EL7532IYZ	INTERSIL	TSSOP50P49-10	MONOLITHIC 2A STEP DOWN REGULATOR, 1.5MHZ, 2.6-5V IN, 0.8 TO VIN OUT
2	Y1-2	HCM4925.000MAB JT	HCM4925.000MAB J-UT	CITIZEN	XTAL_HCM4925_000MABJT	25MHZ CRYSTAL, 18PF, 30PPM CAL. TOL., 50PPM TEMP. TOL.

a. IDT used Pb-free parts where available.



CORPORATE HEADQUARTERS

6024 Silver Creek Valley Road
San Jose, CA 95138

for SALES:

800-345-7015 or 408-284-8200
fax: 408-284-2775
www.idt.com

for Tech Support:

email: ssdhelp@idt.com
phone: 408-284-8208
Document: 60E2000_MA001_03

DISCLAIMER Integrated Device Technology, Inc. (IDT) and its subsidiaries reserve the right to modify the products and/or specifications described herein at any time and at IDT's sole discretion. All information in this document, including descriptions of product features and performance, is subject to change without notice. Performance specifications and the operating parameters of the described products are determined in the independent state and are not guaranteed to perform the same way when installed in customer products. The information contained herein is provided without representation or warranty of any kind, whether express or implied, including, but not limited to, the suitability of IDT's products for any particular purpose, an implied warranty of merchantability, or non-infringement of the intellectual property rights of others. This document is presented only as a guide and does not convey any license under intellectual property rights of IDT or any third parties.

IDT's products are not intended for use in life support systems or similar devices where the failure or malfunction of an IDT product can be reasonably expected to significantly affect the health or safety of users. Anyone using an IDT product in such a manner does so at their own risk, absent an express, written agreement by IDT.

Integrated Device Technology, IDT and the IDT logo are registered trademarks of IDT. Other trademarks and service marks used herein, including protected names, logos and designs, are the property of IDT or their respective third party owners.

Copyright 2009. All rights reserved.

September 2009