



Operating Instructions

AD-3050 Seal Test Equipment



Product: TE-PN: 1201563-2 Rev. D
Raychem-PN: C82893-000

Operating Instructions:
412-94165-1 / 2-744015-6
28.03.2014, RN, Rev. C

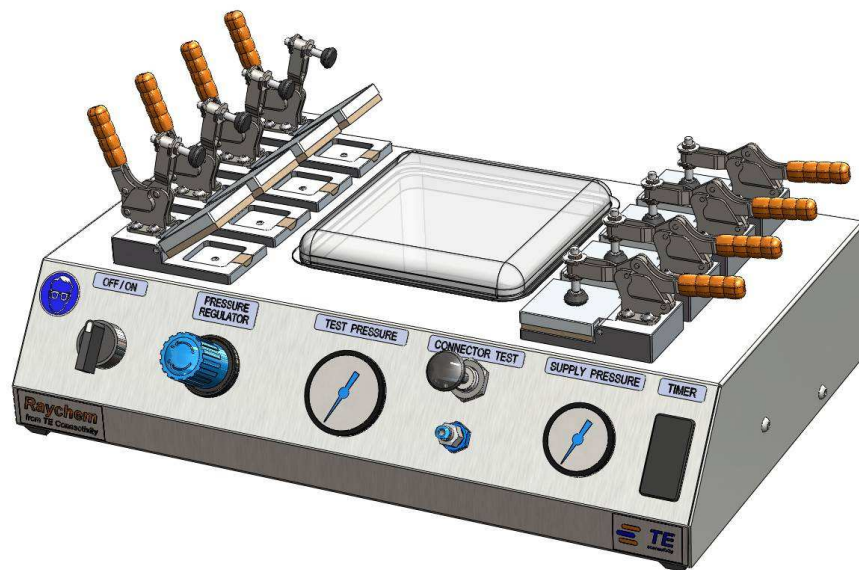

Translation of the German original

The data specified above only serve to describe the product. No statements concerning a safety condition or suitability for a safe application can be derived from our information.

The information given does not release the user from the obligation of own judgment and verification. It must be remembered that our products are subject to a natural process of wear and aging

© This document, as well as the data, specifications and other information set forth in it, are the exclusive property of **TE Connectivity**.

It may not be reproduced or given to third parties without its consent.

The cover page shows a sample configuration. The delivered product may thus differ from the figure.

The original operating instructions have been written in German.

Contents

1	Operating Instructions	5
1.1	Use and handling of the Operating Instructions	
2.	System Description	6
2.1	Introduction	
2.2	General Principles	
2.3	Auxiliary Connections	
2.4	Description of the components	
2.5	Connection to compressed air supply	
2.6	Operator Control Elements	
2.7	Gauges	
3	Safety	12
3.1	General remarks	
3.2	Risk of stumbling	
3.3	Danger of sliding	
3.4	compressed air supply (oil-free)	
3.5	Water (Test medium)	
3.6	Electrical safety	
3.7	Emergency Stop	
3.8	Umbilical Cable	
3.9	Noise Level	
4.	Installation	14
4.1	Scope of delivery	
4.1	Unpacking	
4.2	Installation and settings	
4.3	Air Supply Connections	

5	System Operation	15
5.1	The Toggle Clamps	
5.2	Operating Cycle	
5.2.1	The Toggle Clamp Test	
5.2.2	The Connector Test	
6	Maintenance and Service	19
6.1	General information	
6.2	Safety	
6.3	Care of the AD-3050	
6.4	Maintenance	
6.5	General Inspection	
6.6	Test of seals and gaskets	
6.7	Replacement of defective seals and gaskets	
6.8	Cleaning	
7	Recommend Spares	22
8	Technical Specification	22
9	Service	23

Appendix

- **Assembly drawing**
- **Pneumatic plan**
- **Parts list**
- **Declaration of Conformity**

1 Operating Instructions

This manual describes the TE-Connectivity AD-3050 Seal Test Equipment (*PN: 1201563-2 or C82893-000*). It is intended for use by trained operating and maintenance staff and assumes the equipment has been supplied as a complete unit and is unmodified.

1.1 Use and handling of the Operating Instructions

This manual gives information regarding the safe operation and maintenance of the TE Connectivity AD-3050 Seal Test Equipment. Before operating or maintaining the AD-3050 you must read and understand *Chapter 3. Safety* and *Chapter 4. Installation* later in this manual.

The operator manual must be within reach of the AD-3050 Seal Test Equipment at all times.

All users entrusted with operating the AD-3050 Seal Test Equipment must have read the operator manual and strictly observe the instructions contained therein.

TE Connectivity shall not be liable for damage arising from failure to observe information provided on the tool or in the operator manual.

2 System Description

2.1 Introduction

The AD-3050-SPLICE-SEALEQUIP is a manually operated pneumatic device, intended for use as a convenient 'in-process' sampling technique for checking sealed splices. Different combinations of inline or stub splices can be pressure tested in any of the combination of fixtures (8 cable ends in total). There is also a facility to allow leak testing of various connectors. The tool is also intended to be used as a quick and easy sampling technique for the preliminary selection of installation conditions where TE-Connectivity products are used for the protection of the splice.

There is also the option to install a pneumatic timer, which allows you to specify a defined test period.

TE-Connectivity has seen good correlation between results obtained with the AD-3050 and those obtained through water immersion testing. However testing in accordance with the OEM specification is the only accurate way of confirming that the OEM spec is being met, i.e. using conventional insulation resistance or current leakage test methods.

The splice products are located in clamps which deliver the test pressure. The product is immersed in water and pressure is delivered down the wire(s) to the sealed area. The test result is determined visually by looking for bubbles in the area of the sealing product. Connectors can also be pressure tested by adapting the separate supply fixture to any connector type.

This equipment does not check for poke through i.e. where individual wire strands poke through the installed heat shrinkable sleeve. Poke through is eliminated by ensuring correct welding, crimping and subsequent handling conditions.

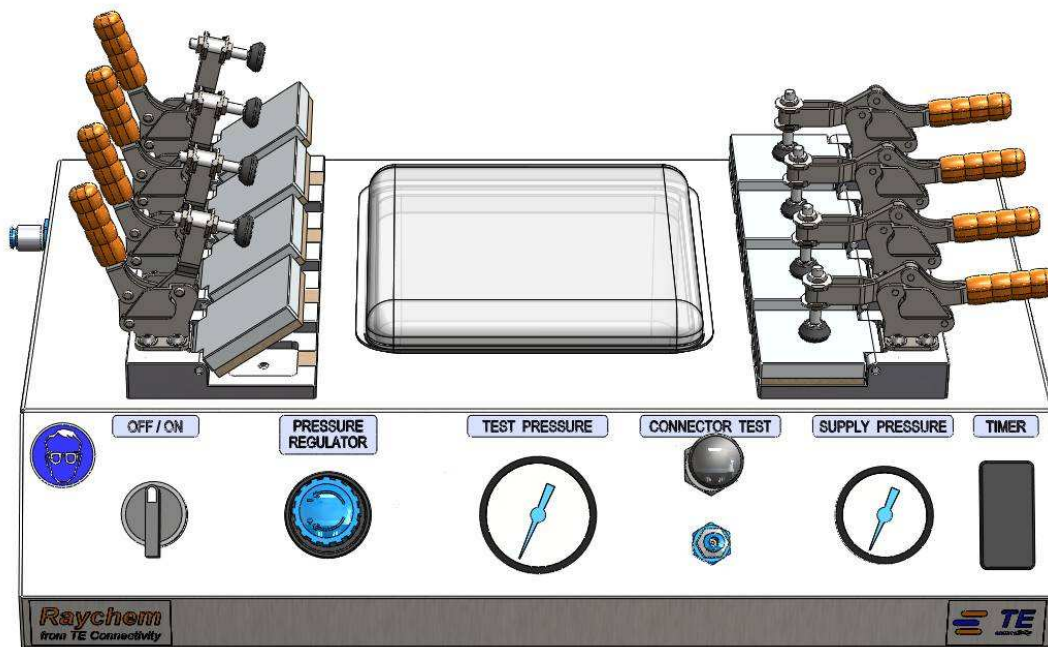

Figure 1. Front view

2.2 General Principles

The splice to be tested is placed in a water bath whilst air passes between the interstices of the conductor and the insulation on each of the cables forming the splice. If the splice seal is good, no air can escape and no air bubbles will be seen. Leaks in the seal will be seen as air bubbles in the water. See *Figure 2*.

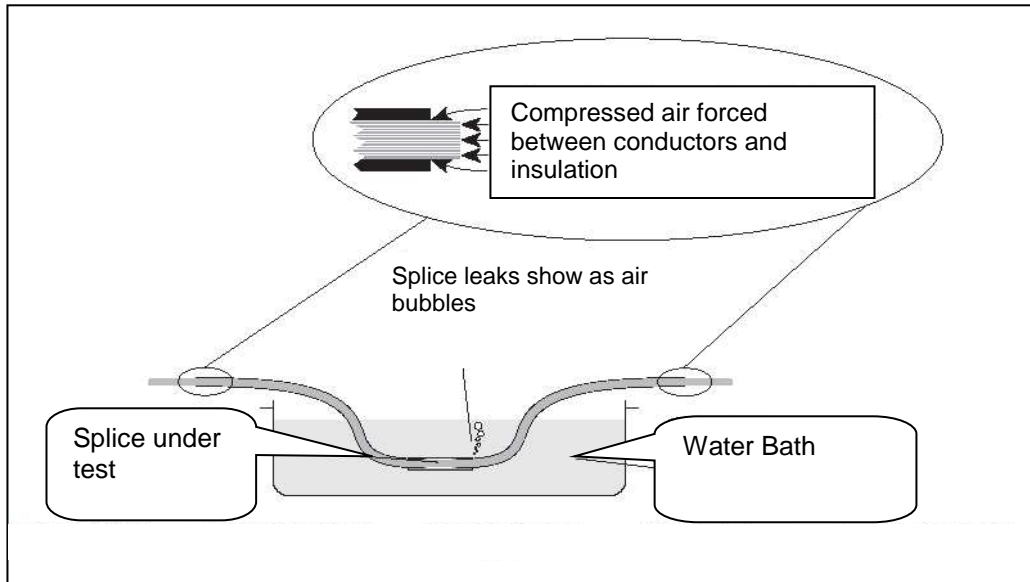

Figure 2.

Toggle clamps are used to hold each of the wires forming the splice. The clamps grip the wires firmly, but without damage, and special gasket materials ensure minimal air losses between the AD-3050 air system and the splice. See *Figure 3*.

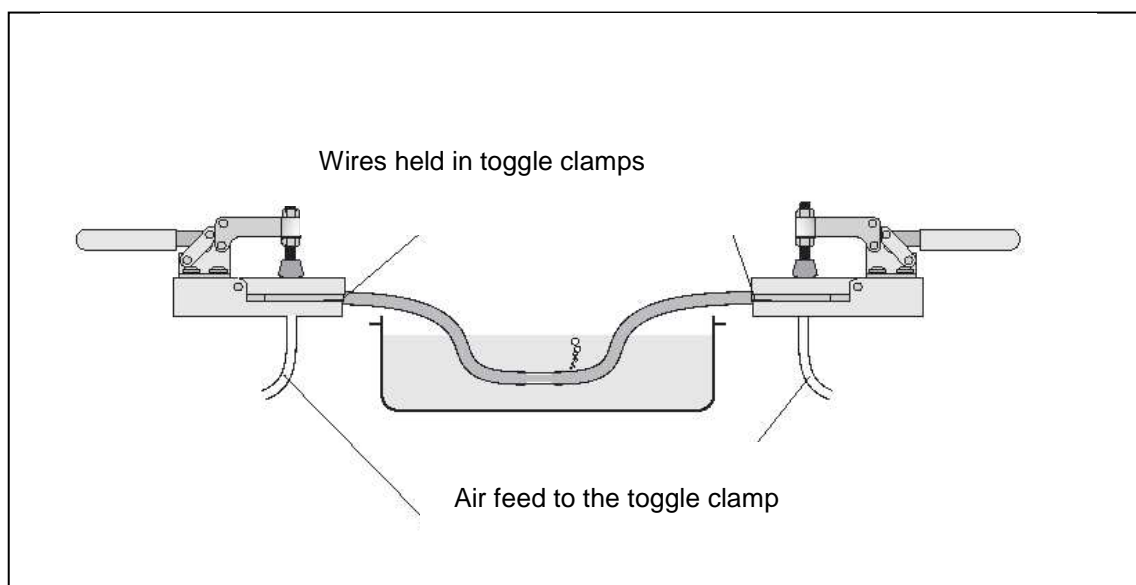

Figure 3.

2.3 Auxiliary Connections (no accessory)

This standard 4mm (o.d) tubing self sealing connector allows you to connect splices and joints to the tester. This facility is useful when testing joints and splices which do not have 'open' cable ends (in-line connectors for example). This connector can be removed to leave a 1/8 BSP female thread, to which a variety of adaptors can be fitted to suit specific requirements.

See example, Figure 4.

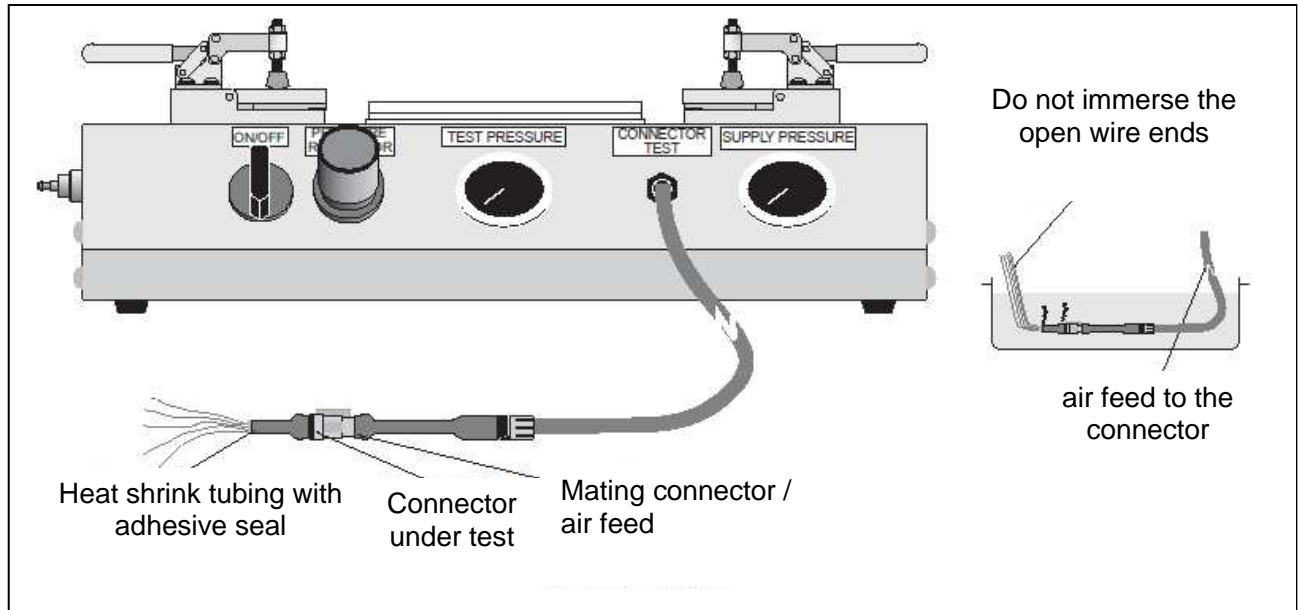

Figure 4.

2.4 Description of the components

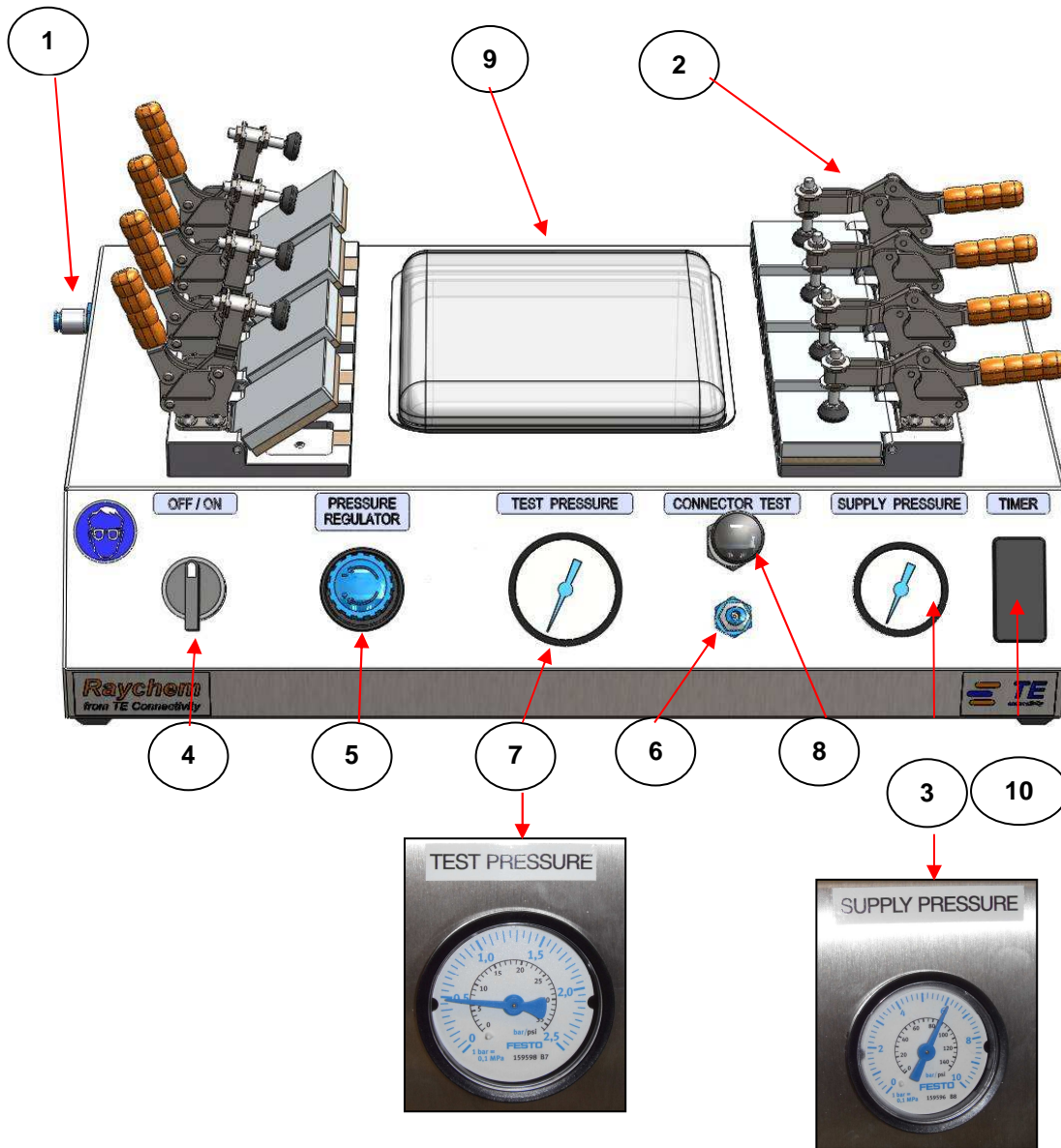

Figure 5. Front and top views

Position	Description
1	Input air supply (max. 6 bar)
2	Toggle clamp (8 pieces) / order-no.: 168927-000 / see chapter 7
3	Supply pressure gauge
4	ON/OFF valve
5	Pressure regulator
6	Push in fitting
7	Test pressure gauge
8	Connector test
9	Plastic container
10	Option: Integration of a pneumatic timer (see further instructions) / see chapter 7

Table 1. Components

2.5 Connection to compressed air supply (Pos. 1 / see Figure 5)

The input air connector is located towards the back of the left hand side of the tester. The connector is barbed fitting type allowing simple connection to most air systems using 6mm i.d. pneumatic tubing.

Connector Test (Pos. 8 / see Figure 5)

The Connector Test outlet is located on the front panel and is a push-in fitting connector for 4mm o.d. tubing type. This is used when testing connectors without 'open' wire ends.

Toggle Clamps (Pos. 2 / see Figure 5)

The eight toggle clamps, on the top of the tester, are used to hold various combinations of splice wires. Usually only one wire is held by each clamp. However if a good seal can be maintained multiple wires may be inserted.

2.6 Operator Control Elements

ON/OFF valve (Pos. 4 / see Figure 5)

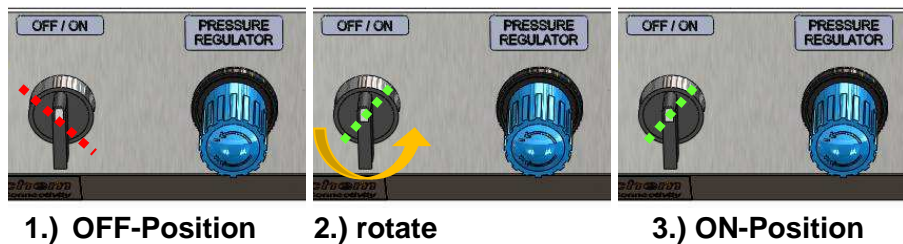

The front panel ON/OFF switch, is a On-off valve.

Pressure Regulator (Pos. 5 / see Figure 5)

The Pressure Regulator is a panel mounted rotary control which restricts the air pressure supplied to the toggle clamps and to the Connector Test outlet. Turning this control clockwise increases the applied test pressure to a maximum of 2.5 bar (see Figure 5).

A typical test pressure of 0.5 bar is used by many automotive OEMs and this can be locked by pushing the control knob towards the front panel.

1) Release adjustment lock

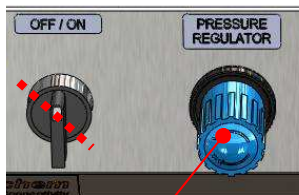

Pressure regulator is locked

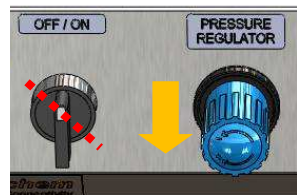

Pressure regulator is unlocked

2) Regulate pressure

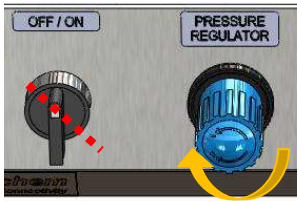

increase pressure

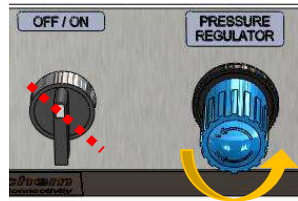

decrease pressure

3) Shut adjustment lock

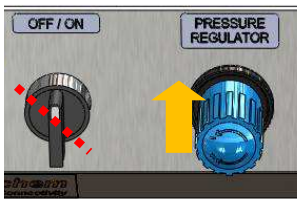

shut



locked position

2.7 Gauges

Test Pressure (Pos. 7 / see Figure 5)

This gauge is mounted centrally on the front panel and shows the air pressure after the Pressure Regulator, i.e. the test pressure applied to the wire ends on the test piece. This pressure is set by careful adjustment of the Pressure Regulator (see Figure 5).

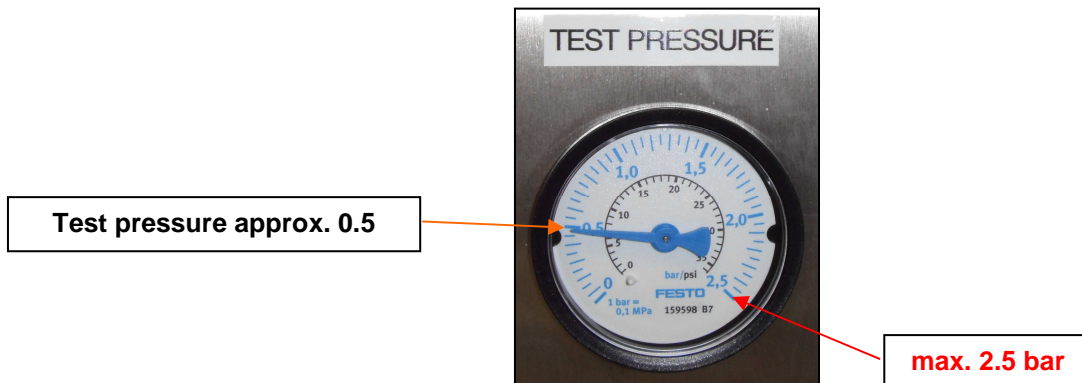

Supply Pressure (Pos 3 / see Figure 5)

Mounted to the right of the front panel this gauge shows the input, unregulated, air pressure. The reading on this gauge is dependant on the input air pressure and cannot be adjusted by the AD-3050 controls (see *Figure 5*).

The **maximum** supply pressure should be **6 bar!**

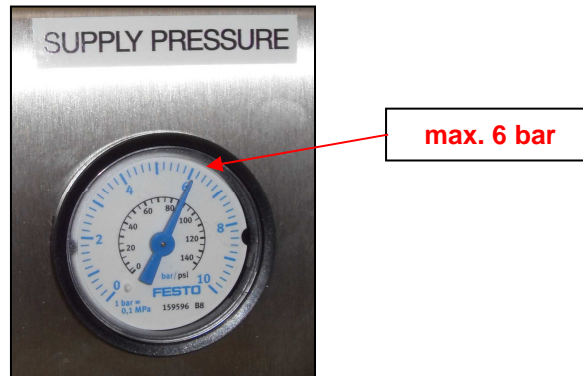

3 Safety

The AD-3050 Seal Test Equipment, in normal use, presents no hazard to the user. Incorrect use of the equipment may cause injury.

The AD-3050 Seal Test Equipment must only be operated by trained and authorised personnel. Carefully read and observe the instructions and warnings in this document.

In the event of unauthorised modifications to the AD-3050 Seal Test Equipment the manufacturer or supplier will not be held liable for resulting damage.

The equipment must be operated in accordance with safe working practices - adhere to local safety codes and regulations. Do not use the equipment for any purpose other than its intended function.

3.1 General remarks



Wear goggles when working with AD-3050-Seal-Test-Equipment!

3.2 Risk of stumbling



Connected pneumatic tube can causes tripping

3.3 Danger of sliding



Danger of slipping on spilled water

3.4 Compressed air supply (oil-free)



The **maximum** input air pressure is **6 bar** and must not be exceeded. Before commencing any pneumatic maintenance or repair, always turn off the equipment and disconnect from the supply. Do not attempt to disconnect the air whilst there is pressure in the system and whilst the equipment is switched on.

3.5 Water (Test medium)



Work only with drinking and pH neutral water!

3.6 Electrical safety



The AD-3050 Seal Test Equipment has no electrical connections. HOWEVER as the equipment uses water, special care should be taken when using the tester near electrical connections and equipment.

3.7 Emergency Stop (Pos. 4 / Figure 5)

The AD-3050 has no separate emergency stop system. The ON/OFF switch is used to disconnect the toggle clamp air supply.

3.8 Umbilical Cable

Apart from the air supply and the possible connection to the auxiliary test port the AD-3050 is not controlled by or connected to any other equipment. No special precautions are required.

3.9 Noise Level

The audible noise from the AD-3050 is negligible.

4 Installation

4.1 Scope of delivery

- AD-3050-Seal-Test-Equipment
- Operating Instruction
- assembly drawing, pneumatic plan and parts list
- Declaration of Conformity

4.2 Unpacking

The AD-3050 is supplied in a heavy duty, foam lined, aluminium case which provides sturdy protection. To avoid movement during transit the tester fits into the case. It must be removed carefully to avoid damage to the AD-3050 and the foam lining in the case. Remove the equipment and inspect it for transit damage. Check that all items have been supplied. Contact Raychem for assistance if required. The equipment may be supplied with the clamps in the closed position. This may cause the seals to deform slightly. It is therefore recommended to open the clamps as soon as the equipment is unpacked, and to leave the clamps in the open position when it is not in use.

4.3 Installation and settings

The AD-3050 has an open base and should be operated from a horizontal, smooth surface. This will avoid damage to the exposed airlines, connections and controls.

Aufstellen

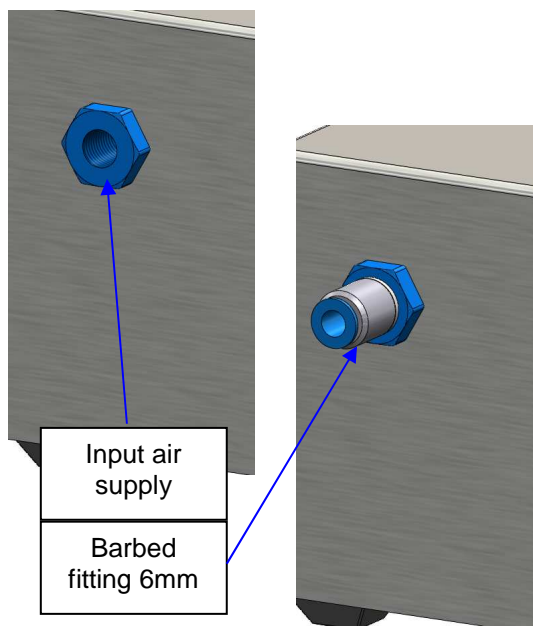

4.4 Air supply connections

The AD-3050 should be located within easy reach of a suitable compressed air supply (**6 bar maximum**).



Avoid long runs of input air tubing especially in areas where other personnel are working.

5 System Operation



Before operating the AD-3050 check the equipment using the procedures given in *Chapter 6*. Set all switches and the air regulator to the off position prior to use.



Before operating the AD-3050 tester, you should ensure you are familiar with the system connections and controls (*Chapter 2.*) and the safety requirements (*Chapter 3.*)

5.1 The Toggle Clamps

Toggle clamps are opened by lifting the operating handle towards the vertical position and closed by returning the handle to the horizontal. The top toggle clamp plate must be raised and lowered manually. (See *Figure 6*)

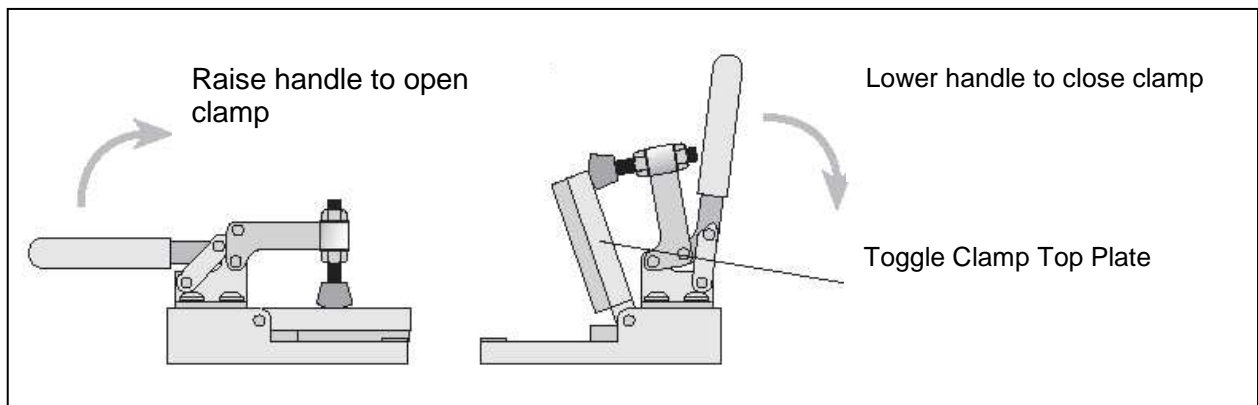

Figure 6.

5.2 Operating Cycle

5.2.1 The Toggle Clamp Test

1. Ensure the ON/OFF valve is in the **OFF** position and that the pressure regulator is turned fully anti-clockwise (minimum pressure).
Push the button of the push in fitting in back position



OFF-Position

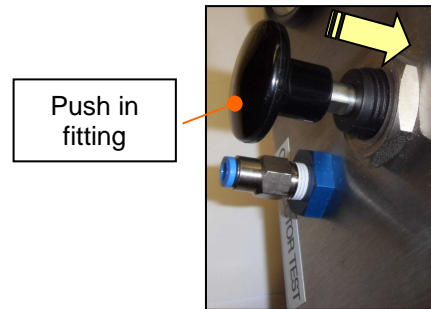

Push button in back position

2. Connect the input air supply.
3. Fill the test reservoir with clean water to within 15mm of the top edge.
Note: *It is recommended that the water is replaced weekly.*
4. Carefully fit the wires of the splice to be tested into the toggle clamp fixings. Take care to minimise the air losses at each joint especially when more than one wire is fitted into a single toggle clamp.
5. When all wires have been fitted, ensure **all** toggle clamps are closed.



6. Totally submerge the splice in the water reservoir.
7. Turn the **ON/OFF valve** to the **ON** position.
8. Slowly turn the pressure regulator clockwise until the required test pressure is indicated on the Test Pressure gauge. (**0.5 bar is a normal test pressure in the automotive industry.**)
9. Maintain this test pressure for min. 30 seconds whilst checking the submerged splice for air bubbles at the point(s) where the wires enter and leave the splice.

Note: *Although 30s is recommended for each test, as a general guide bubbles are normally seen within 5 seconds if the splice is not sealed. Air bubbles from the splice may indicate:*

- The wrong size of shrink tube has been used.
- The splice has been made incorrectly (insufficient insulation cut back or incorrect installation conditions or product selection).
- The splice has been contaminated during manufacture.
- Incorrect installation conditions have been used.

Note: Air bubbles entrapped on the surface of the splice does not indicate a failure.

- When the test is complete, reduce the test pressure by turning the pressure regulator anti-clockwise and then turning the **ON/OFF valve** to the **OFF** position.
- Open the toggle clamps and remove the tested splice.
- Disconnect the input air supply.
- Record details of the test in accordance with your Quality Procedures.

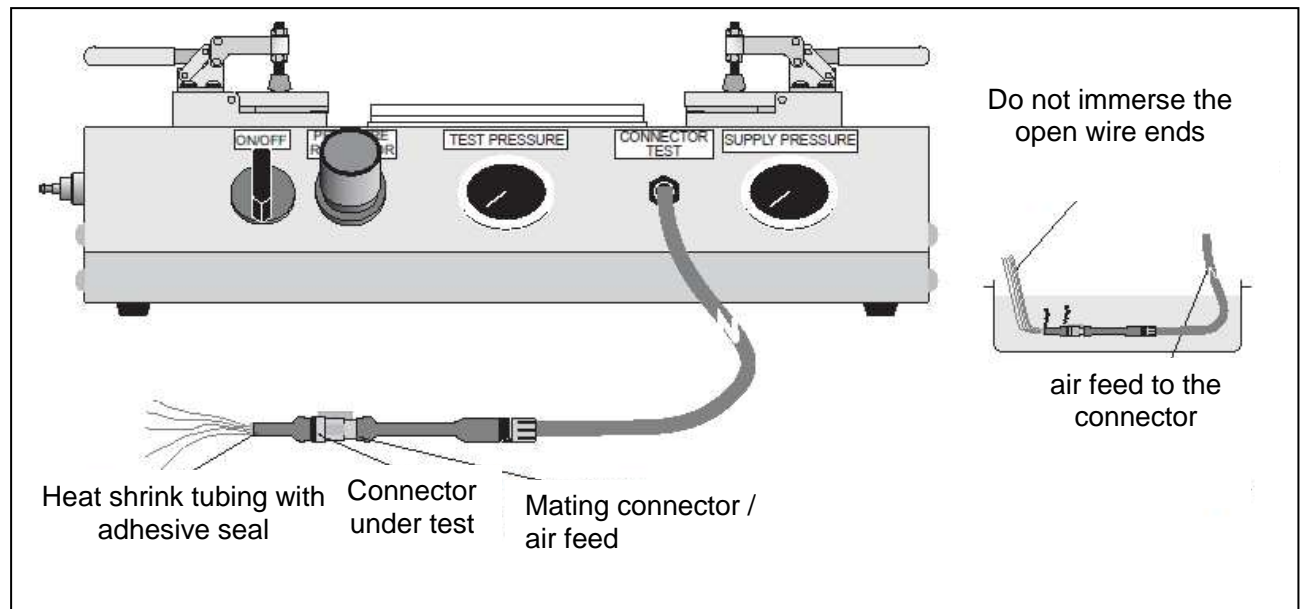

Figure 7. Connector Test

5.2.2 The Connector Test

- Ensure the ON/OFF valve is in the **OFF** position (vertical) and that the pressure regulator is turned fully anti-clockwise (minimum pressure). Pull the button of the push in fitting forward to the front position.



OFF-Position

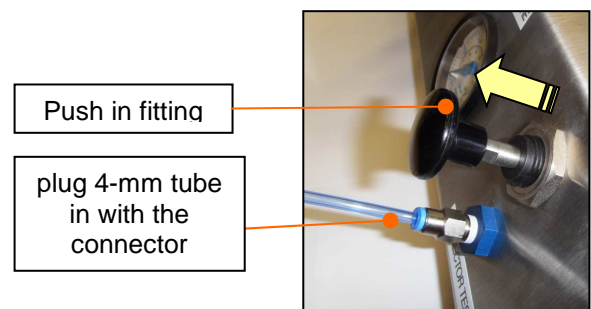

Push the button

-
2. Connect the input air supply.
 3. Fill the test reservoir with clean water to within 15mm of the top edge.
Note: *It is recommended that the water is replaced weekly.*
 4. Connect the test piece to the Connector Test outlet on the front panel.
 5. Ensure **all** toggle clamps are closed.
 6. Totally submerge the connector in the water reservoir, but **not** the non connector ends of the wires.
 7. Turn the **ON/OFF valve** to the **ON** position.
 8. Slowly turn the pressure regulator clockwise until the required test pressure is indicated on the Test Pressure gauge. (0.5 bar is a normal test pressure in the automotive industry).
 9. Maintain this test pressure for 30 seconds whilst checking the submerged connector for air bubbles at the joint seal, i.e. at the tubing/connector interface and at the rear end of the tubing, in-between the wires. *Air bubbles from the seal may indicate:*
 - *The wrong size of shrink tube or adhesive profile, if required, has been used.*
 - *The tubing or adhesive profile position are incorrect.*
 - *Incorrect installation conditions have been used.*
Note: *Air bubbles entrapped on the surface of the test piece does not indicate a failure.*
 10. When the test is complete, reduce the test pressure by turning the pressure regulator anti-clockwise and then turning **the ON/OFF valve** to the **OFF** (vertical) position.
 11. Disconnect the test piece from the Connector Test outlet.
 12. Disconnect the input air supply.
 13. Record details of the test in accordance with your Quality Procedures.

6 Maintenance and Service

6.1 General information



- All maintenance and servicing of this equipment must be performed by suitably qualified personnel.
- For maintenance make sure that the inlet pneumatic tube is **disconnected** from the AD-350-Seal-Test.
- The pneumatic system must be pressureless.

6.2 Safety

Ensure that you read and understand *Chapter 3. Safety*. Before proceeding with any maintenance or servicing ensure that all controls are in the **OFF** position and the compressed air supply is disconnected.

6.3 Care of the AD-3050

The AD-3050 is designed to operate correctly with minimal service and maintenance. When the equipment is not being used maintenance and service requirements can be minimised by:

1. Disconnecting the tester from the input air supply.
2. Leaving all toggle clamps in the open position.
3. Periodically check (and realign) the toggle clamp seals. These may have moved slightly during pressure testing.

6.4 Maintenance

- General Inspection
- Seals Test
- Seals Replacement
- Cleaning

6.5 General Inspection

Before any testing is started the following inspections and tests should be made:



The AD-3050 tester should be disconnected from the input air supply during this procedure.

1. Check the equipment for any signs of damage or contamination.
2. Check the operation of all controls and switches.
3. Check the operation of the toggle clamps.
4. Check the clamp seals using chapter **6.6 Seals Tests**.
5. Check all air lines for signs of leakage.

Any faulty or damaged parts found must be replaced or repaired before testing starts.

6.6 Test of seals and gaskets

1. Turn the **ON/OFF valve** to the **OFF** position.
2. Turn the pressure regulator fully anti-clockwise.
3. Remove all wires from the toggle clamps.
4. Check all seals are correctly aligned (see *Figure 8*).
5. Close all toggle clamps.
6. Connect the input air supply.
7. Turn the **ON/OFF valve** to the **ON** position.
8. Slowly turn the pressure regulator clockwise until 0.5 bar is shown on the Test Pressure gauge.
9. Check all toggle clamps for signs of excess air leakage.
Note: *a small amount of air leakage is unavoidable, but this must be minimised.*
10. Replace any faulty clamp seals using chapter **6.7 Seal Replacement**.
11. When all clamps have been checked, reduce the test pressure.
12. Turn the **ON/OFF valve** to the **OFF** position.

6.7 Replacement of defective seals and gaskets

This should normally be required approximately every 4 months for average use. However, type of test, type of wires etc. may cause this period to be reduced. A faulty seal is one which is either:

- *in the wrong position (and cannot be repositioned due to lack of adhesion)*
- *deformed or*
- *damaged*

If faulty seals have been identified they should be replaced as follows. You will need AD-3050-SEAL-8-KIT (PN:9-1192264-3), which comprises sufficient seal material for all 8 clamps, to complete this operation. (See *Chapter 7. Recommended Spares*)

1. Disconnect the tester from the input air supply.
2. Open the toggle clamps.
3. Remove the faulty gasket material and clean and dry the clamp surfaces with a suitable degreasing agent (not solvent). Remove all debris, adhesive etc., without damaging the surface.
4. Remove the protective paper backing from the gasket material and fit new 'square gaskets' to the top plates as required (see *Figure 8*.)

5. Cut 50mm and 20mm lengths of the 600mm strip material as required. Remove the protective paper backing from the gasket material and fit them to the bottom plates (see *Figure 8.*).
6. Press the new gaskets firmly to ensure bonding to the toggle clamp plates.
7. Close the clamps for approximately 1 hour to allow air to be excluded and for the bond to strengthen. Repeat the *Seals Tests* procedure until air leakage is minimal.

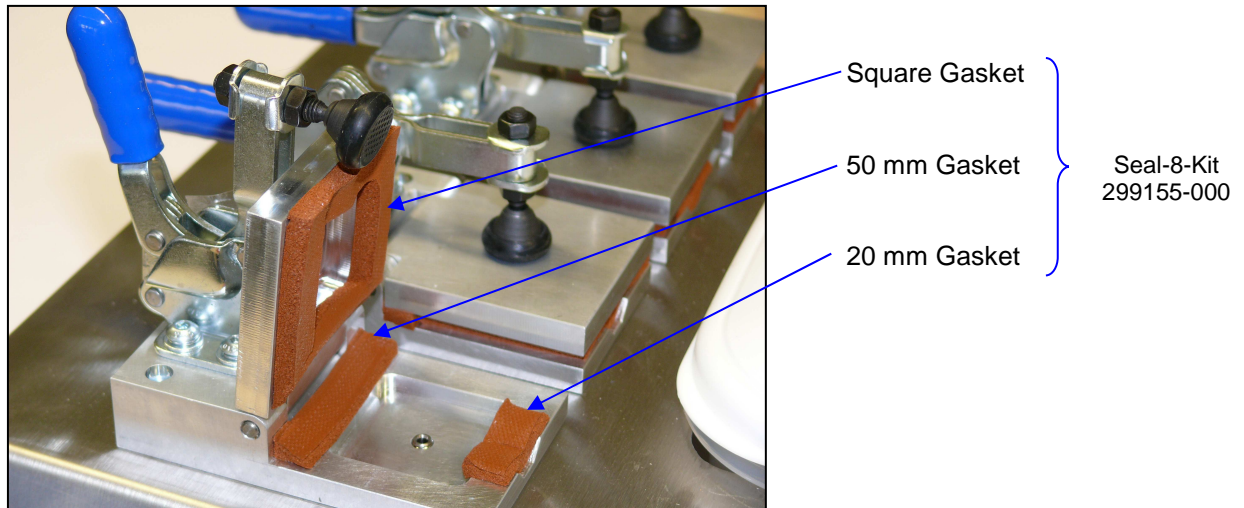

Figure 8. Mounting Seal-Kit (Order-no.: 299155-000)

Content of one Seal-8-Kit: eight Square Gaskets and one long strip (approx. 600mm)

6.8 Cleaning

The equipment may be cleaned using a damp 'lint free' cloth.



Abrasive cleaners should not be used.

7 Recommended Spares

Order number TE Connectivity	Order number Raychem	Description
	168927-000	AD-3050-SEAL-CLAMP-ASSY
	299155-000	AD-3050-SEAL-8-KIT
4-529533-7		TIMER UPGRADE KIT

8 Technical Specification

Pneumatic Supply:

Maximum Supply Pressure: 6 bar - filtered air, oil-free
 Maximum Test Pressure: 2,5 bar
 Typical Test Pressure: 0,5 bar

Seal Testing Cycle Time: Typically 30 seconds

Test Medium: drinking water, ph-neutral

Noise Level: << 70 dB

Dimensions (excluding case and connectors):

Width: 550 mm
 Depth: 350 mm
 Height: 215 mm

Weight: 4 kg

Order Informations:

Product Description: AD-3050 SEAL TEST EQUIPMENT
 Order number: Raychem-PN: C82893-000

9 Service

Please contact our Customer Service if there are any problems or feature requests.

Service Address:

Field Service EMEA TE Application Tooling Tyco Electronics AMP GmbH c/o Schenck Technologie- und Industriepark GmbH Landwehrstr. 55 / Gebäude 83 (oder optional 74) 64293 Darmstadt / GERMANY +49 6151 607 1518 tel +49 6151 607 1317 fax FieldServiceEMEA@te.com
--

When contacting our service department, please make sure to have the following pieces of information at hand:

- Machine type
- Serial number

Product informations available under: <http://www.te.com>

Tyco Electronics AMP GmbH
a TE Connectivity Ltd. company
Ampèrestr. 12–14
64625 Bensheim / Germany
Phone: +49-6251-133-0
Fax: +49-6251-133-1600

www.te.com

Support-Center: <http://www.te.com/support-center>

Tyco Electronics AMP GmbH certified
acc. ISO 14001 and ISO/TS 16949:2002

© 2012 Tyco Electronics Corporation. All rights reserved.

Raychem, SOLARLOK, TE Connectivity
and TE connectivity (logo) are trademarks.

Other products, logos and company names mentioned herein
may be trademarks of their respective owners.

2-744015-6 issued 10-2012 in Germany.

