

# MultiConnect™ AW

## Analog-to-Wireless Converter



User Guide



**MultiConnect™ AW User Guide**  
**MT200A2W-G, MT200A2W-C1, MT200A2W-H5**

S000504, Revision J

**Copyright**

This publication may not be reproduced, in whole or in part, without the specific and express prior written permission signed by an executive officer of Multi-Tech Systems, Inc. All rights reserved. Copyright © 2011-2013 by Multi-Tech Systems, Inc.

Multi-Tech Systems, Inc. makes no representations or warranties, whether express, implied or by estoppels, with respect to the content, information, material and recommendations herein and specifically disclaims any implied warranties of merchantability, fitness for any particular purpose and non-infringement.

Multi-Tech Systems, Inc. reserves the right to revise this publication and to make changes from time to time in the content hereof without obligation of Multi-Tech Systems, Inc. to notify any person or organization of such revisions or changes.

**Trademarks**

Multi-Tech and the Multi-Tech logo are registered trademarks and MultiConnect is a trademark of Multi-Tech Systems, Inc. All other brand and product names are trademarks or registered trademarks of their respective companies.

**Revisions**

<b>Revision</b>	<b>Date</b>	<b>Description</b>
D	09/08/11	Add –C1, Sprint version
E	12/05/12	Added pacemaker and medical device information, updated RoHS, and power draw
F	04/16/13	Added –H5
G	12/19/13	Added UL translations
H	06/09/14	Antenna warning
I	4/26/17	Corrections
J	5/19/17	Added content for RED Compliance

**Contacting Multi-Tech Knowledge Base**

The Knowledge Base provides immediate access to support information and resolutions for all Multi-Tech products. Visit <http://www.multitech.com/kb.go>.

**Installation Resources**

To download manuals, firmware, and software, visit <http://www.multitech.com/setup/product.go>.

**Support Portal**

To create an account and submit a support case directly to our technical support team, visit: <https://support.multitech.com>

**Technical Support**

Business Hours: M-F, 9am to 5pm CT

<b>Country</b>	<b>By Email</b>	<b>By Phone</b>
Europe, Middle East, Africa:	support@multitech.co.uk	+(44) 118 959 7774
U.S., Canada, all others:	support@multitech.com	(800) 972-2439 or (763) 717-5863

**World Headquarters**

Multi-Tech Systems, Inc.  
2205 Woodale Drive  
Mounds View, Minnesota 55112  
Phone: 763-785-3500 or 800-328-9717  
Fax: 763-785-9874

**Warranty**

To read the warranty statement for your product, please visit: <http://www.multitech.com/warranty.go>



# Contents

<b>Chapter 1 – Product Overview .....</b>	<b>7</b>
<b>Features .....</b>	<b>7</b>
<b>AT Command Information.....</b>	<b>8</b>
<b>Safety.....</b>	<b>8</b>
RF Safety .....	8
Interference with Pacemakers and Other Medical Devices.....	9
Handling Precautions.....	9
Device Maintenance .....	10
Vehicle Safety.....	10
<b>Front Panel.....</b>	<b>11</b>
<b>Package Contents.....</b>	<b>11</b>
<b>Specifications .....</b>	<b>12</b>
MT200A2W-G .....	12
MT200A2W-C1.....	13
MT200A2W-H5 .....	15
HE910 Telit Transmission Output Power .....	16
<b>Power .....</b>	<b>17</b>
Power draw for MT200A2W-G .....	17
Power Draw for the MT200A2W-H5 (GSM850/HSDPA).....	17
Power Draw for the MT200A2W-C1 .....	18
<b>Cellular Information .....</b>	<b>18</b>
Antenna System for Cellular Devices.....	18
PTCRB Requirements for the Antenna.....	19
FCC Requirements for the Antenna .....	19
<b>Antenna Specifications.....</b>	<b>19</b>
HSPA+ Antenna Requirements/Specifications.....	19
CDMA Antenna Requirements/Specifications .....	19
GSM Antenna Requirements/Specifications.....	19
<b>Command Connector .....</b>	<b>20</b>
<b>Chapter 2 – Installation .....</b>	<b>21</b>
<b>Account Activation for Wireless Devices .....</b>	<b>21</b>
<b>Insert the SIM Card into Holder.....</b>	<b>21</b>
<b>Connect the Antenna, Serial and Modem Cables, and Power .....</b>	<b>21</b>
Dial Port Caution.....	21
<b>Optional – Attach the Modem to a Flat Surface .....</b>	<b>22</b>

<b>Chapter 3 – Configuring Ports</b> .....	<b>24</b>
<b>Connecting to the Device</b> .....	<b>24</b>
<b>Logging In</b> .....	<b>25</b>
<b>Configuring the Port</b> .....	<b>26</b>
GPRS Cellular Port Configuration .....	26
GSM Cellular Port Configuration .....	27
CDMA Cellular Port Configuration .....	29
<b>Chapter 4 – Device Configuration</b> .....	<b>30</b>
<b>Introduction Menu</b> .....	<b>30</b>
<b>Device Configuration</b> .....	<b>31</b>
<b>Cellular Port Configuration</b> .....	<b>31</b>
GPRS Cellular Port Configuration .....	32
GSM Cellular Port Configuration .....	35
CDMA Cellular Port Configuration .....	36
<b>View or Change Phone Number/IP Conversion Table</b> .....	<b>37</b>
<b>Analog (PSTN) Port Configuration</b> .....	<b>37</b>
PSTN Modem Settings .....	38
<b>System Login</b> .....	<b>39</b>
Setting up a Secret Question .....	39
<b>Timers</b> .....	<b>40</b>
<b>Reset Parameters to Defaults</b> .....	<b>40</b>
<b>System Reboot</b> .....	<b>41</b>
<b>Enable Debug</b> .....	<b>41</b>
<b>Chapter 5 – Upgrading Firmware</b> .....	<b>42</b>
<b>Determining if You Need to Upgrade the Firmware</b> .....	<b>42</b>
<b>Downloading the Upgrade File and the Flash Wizard</b> .....	<b>42</b>
<b>Identifying the COM port</b> .....	<b>43</b>
<b>Upgrading Firmware</b> .....	<b>43</b>
<b>Restoring Parameters</b> .....	<b>45</b>
<b>Chapter 6 – Configuration Scripts</b> .....	<b>46</b>
<b>GPRS/GSM Configuration Script Example</b> .....	<b>46</b>
<b>CDMA Configuration Script Example</b> .....	<b>50</b>
<b>Chapter 7 – Troubleshooting</b> .....	<b>54</b>
<b>Flashing Signal Strength LEDs</b> .....	<b>54</b>
<b>Appendix A – Regulatory Compliance</b> .....	<b>55</b>
<b>EMC, Safety, and Radio Equipment Directive (RED) Compliance</b> .....	<b>55</b>
<b>International Modem Restrictions</b> .....	<b>55</b>
<b>47 CFR Part 15 Regulation Class B Devices</b> .....	<b>55</b>
<b>Industry Canada</b> .....	<b>56</b>

<b>Waste Electrical and Electronic Equipment Statement .....</b>	<b>56</b>
WEEE Directive.....	56
Instructions for Disposal of WEEE by Users in the European Union .....	56
<b>REACH Statement.....</b>	<b>57</b>
Registration of Substances.....	57
Substances of Very High Concern (SVHC) .....	57
<b>Restriction of the Use of Hazardous Substances (RoHS) .....</b>	<b>58</b>
<b>Information on HS/TS Substances According to Chinese Standards.....</b>	<b>59</b>
<b>Information on HS/TS Substances According to Chinese Standards (in Chinese) .....</b>	<b>60</b>
依照中国标准的有毒有害物质信息.....	60

# Chapter 1 – Product Overview

The MultiConnect™ AW Analog-to-Wireless converter is a convenient turnkey solution that allows legacy equipment with built-in analog modems to connect to a cellular network. By emulating the traditional dial-up PSTN network and using a cellular modem, the affordable MultiConnect AW converter gives new life to devices currently using traditional analog dial-up communications.

- The MultiConnect AW model (MT200A2W-G) with either internal GPRS or GSM cellular modem allows connection to the cellular packet data network (GPRS) or the circuit switched data network (GSM).
- The MultiConnect AW model (MT200A2W-C1) with an internal CDMA cellular modem allows connection to a CDMA 2000 1xRTT cellular network.
- The MultiConnect AW model (MT200A2W-H5) with an internal HSPA+ modem allows connection to a HSPA+ network.

The MultiConnect AW converter operates on standards-based communication networks and can be desktop or panel mounted.



MT200A2W-G and MT200A2W-H5



MT200A2W-C1

## Features

- Quad-band GSM/EGSM 850/900/1800/1900 MHz (MT200A2W-G)
- Dual-band CDMA2000 1xRTT (MT200A2W-C1)
- Penta-band HSPA+ 850/900/1700/1900/2100 MHz (MT200A2W-H5)
- Packet data up to 85.6 Kbps (MT200A2W-G)
- CDMA speeds 153K bps forward and reverse (MT200A2W-C1)
- Circuit-switched data up to 14.4 kbps (MT200A2W-G only. MT200A2W-H5 and MT200A2W-C1 do not support this protocol)
- Analog connection speed up to 33600 (V34)
- Serial interface used for configuration and debug, fixed speed @ 115200
- On hook, off hook, and DTMF digit detection
- Dial tone and busy tone generation
- Phone number to IP conversion
- Device configuration via menu selections
- Device initialization script

## AT Command Information

The AT commands for the MultiConnect AW are published in separate documents. These commands are documented in the Reference Guide for the GPRS AT Commands for Multi-Tech G2 Cellular Modems (MT200A2W-G), the Reference Guide for the CDMA C1 AT Commands for the Multi-Tech Modems or the H5 AT Commands for Multi-Tech H5 modems. You can download these documents from the Multi-Tech website.

## Safety

### Power Supply Caution

**CAUTION:** Do not replace the power supply with one designed for another product; doing so can damage the modem and void your warranty.

**CAUTION:** Pour garantir une protection continue contre les risques d'incendie, remplacez les fusibles uniquement par des fusibles du même type et du même calibre.

### RF Safety

Due to the possibility of radio frequency (RF) interference, it is important that you follow any special regulations regarding the use of radio equipment. Follow the safety advice given below.

**CAUTION:** Maintain a separation distance of at least 20 cm (8 inches) between the transmitter's antenna and the body of the user or nearby persons. The modem is not designed for or intended to be used in portable applications within 20 cm of the user's body.

Check your local standards regarding safe distances, etc.

- Operating your device close to other electronic equipment may cause interference if the equipment is inadequately protected. Observe any warning signs and manufacturers' recommendations.
- Different industries and businesses restrict the use of cellular devices. Respect restrictions on the use of radio equipment in fuel depots, chemical plants, or where blasting operations are in process. Follow restrictions for any environment where you operate the device.
- Do not place the antenna outdoors.
- Switch OFF your wireless device when in an aircraft. Using portable electronic devices in an aircraft may endanger aircraft operation, disrupt the cellular network, and is illegal. Failing to observe this restriction may lead to suspension or denial of cellular services to the offender, legal action, or both.
- Switch OFF your wireless device when around gasoline or diesel-fuel pumps and before filling your vehicle with fuel.
- Switch OFF your wireless device in hospitals and any other place where medical equipment may be in use.

### Sécurité RF

En raison de la possibilité d'interférences de radiofréquence (RF), il est important que vous suiviez une quelconque réglementation concernant l'utilisation du matériel radio. Suivez les conseils de sécurité ci-dessous.

**ATTENTION:** Maintenir une distance d'au moins 20 cm (8 po) entre l'antenne du récepteur et le corps de l'utilisateur ou à proximité de personnes. Le modem n'est pas conçu pour, ou destinés à être utilisés dans les applications portables, moins de 20 cm du corps de l'utilisateur.

Vérifiez vos normes locales touchant les distances de sécurité, etc..



- Fonctionnement de votre appareil à proximité d'autres appareils électroniques peuvent causer des interférences si l'équipement est insuffisamment protégé. Respectez les panneaux d'avertissement et les recommandations du fabricant.
- Différentes industries et les entreprises limitent l'utilisation des appareils cellulaires. Respectez les règlements sur l'utilisation des équipements radio dans les dépôts de carburant, les usines chimiques, ou lorsque des opérations de dynamitage sont en cours. Suivez restrictions pour n'importe quel environnement où vous utilisez l'appareil.
- Ne pas placer l'antenne à l'extérieur.
- Éteignez votre appareil sans fil dans un avion. Utilisant des dispositifs électroniques portables dans un avion peut mettre en danger le fonctionnement de l'avion, peut perturber le réseau cellulaire, et est illégal. Le non-respect de cette restriction peut entraîner la suspension ou le refus des services cellulaires au contrevenant, une action en justice, ou les deux.
- Éteignez votre appareil sans fil lorsque autour de l'essence ou pompes diesel-carburant et avant de remplir votre véhicule avec du carburant.
- Éteignez votre appareil sans fil dans les hôpitaux et tout autre endroit où l'équipement médical peut être utilisé.

## Interference with Pacemakers and Other Medical Devices

### Potential interference

Radio frequency energy (RF) from cellular devices can interact with some electronic devices. This is electromagnetic interference (EMI). The FDA helped develop a detailed test method to measure EMI of implanted cardiac pacemakers and defibrillators from cellular devices. This test method is part of the Association for the Advancement of Medical Instrumentation (AAMI) standard. This standard allows manufacturers to ensure that cardiac pacemakers and defibrillators are safe from cellular device EMI.

The FDA continues to monitor cellular devices for interactions with other medical devices. If harmful interference occurs, the FDA will assess the interference and work to resolve the problem.

### Precautions for pacemaker wearers

If EMI occurs, it could affect a pacemaker in one of three ways:

- Stop the pacemaker from delivering the stimulating pulses that regulate the heart's rhythm.
- Cause the pacemaker to deliver the pulses irregularly.
- Cause the pacemaker to ignore the heart's own rhythm and deliver pulses at a fixed rate.

Based on current research, cellular devices do not pose a significant health problem for most pacemaker wearers. However, people with pacemakers may want to take simple precautions to be sure that their device doesn't cause a problem.

- Keep the device on the opposite the side of the body from the pacemaker to add extra distance between the pacemaker and the device.
- Avoid placing a turned-on device next to the pacemaker (for example, don't carry the device in a shirt or jacket pocket directly over the pacemaker).

## Handling Precautions

All devices must be handled with certain precautions to avoid damage due to the accumulation of static charge. Although input protection circuitry has been incorporated into the devices to minimize the effect of this static build up, proper precautions should be taken to avoid exposure to electrostatic discharge during handling and mounting.

## Device Maintenance

To maintain the MultiConnect:

- Do not attempt to disassemble the device. There are no user serviceable parts inside.
- Do not expose your device to any extreme environment where the temperature or humidity is high.
- Do not expose the device to water, rain, or spilled beverages. It is not waterproof.
- Do not place the device alongside computer discs, credit or travel cards, or other magnetic media. The information contained on discs or cards may be affected by the phone.
- Rough handling, such as dropping or shaking it, can damage the device.
- Using accessories that Multi-Tech has not authorized or that are not compliant with Multi-Tech's accessory specifications may invalidate the warranty.

If the device is not working properly, contact Multi-Tech Technical Support.

## Vehicle Safety

When using your device in a vehicle:

- Do not use this device while driving.
- Respect national regulations on the use of cellular devices in vehicles.
- If incorrectly installed in a vehicle, operating the wireless device could interfere with the vehicle's electronics. To avoid such problems, use qualified personnel to install the device. The installer should verify that the vehicle electronics are protected from interference.
- Using an alert device to operate a vehicle's lights or horn is not permitted on public roads.
- UL evaluated this device for use in ordinary locations only. UL did NOT evaluate this device for installation in a vehicle or other outdoor locations. UL Certifications does not apply or extend to use vehicles or outdoor applications.

## Front Panel

The front panel displays three Signal Strength LEDs, a Carrier Detect LED, a Link Status LED, and a Power LED. Signal Strength LEDs display the internal wireless device signal level when they are on; when they flash, a failure has occurred. Refer to Chapter 7 for a description of the flashing Signal Strength LEDs.

- The Carrier Detect LED works for both analog and wireless. When solidly ON, both connections are established.
- The Link Status LED lights when the unit is registering with the network and blinks when the unit is registered with the network.
- The Power LED lights when power is supplied to the unit.
- The SIM door on the right side provides access to the SIM card holder.

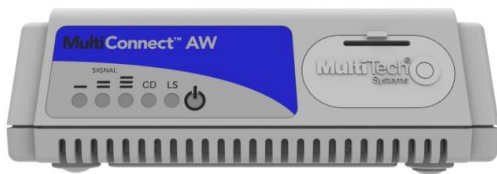

MT200A2W-G and MT200A2W-H5

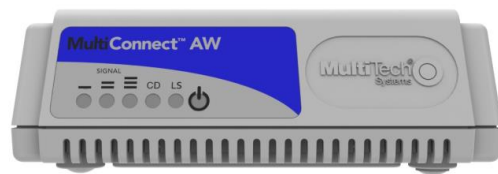

MT200A2W-C1

### LEDs

LED Indicators	
Signal	<p><b>ALL OFF</b> - Unit is off, not registered on network, or extremely weak signal (RSSI &lt;7).</p> <p><b>1 Bar "ON"</b> – Very weak signal (7 &lt;= RSSI &lt;=14)</p> <p><b>1 Bar and 2 Bar "ON"</b> – Weak signal (15 &lt;= RSSI &lt;=23)</p> <p><b>1 Bar, 2 Bar, and 3 Bar "ON"</b> – Good signal ( 24&lt;= RSSI &lt;= 31)</p>
CD	<p><b>CD – Carrier Detect</b> – The Carrier Detect LED has three states.</p> <p><b>Slow Blink</b> – Waiting for wireless connection.</p> <p><b>Fast Blink</b> – After the wireless connection, a fast blink indicates waiting for analog connection.</p> <p><b>Solid Blink</b> – Both sides are connected.</p>
LS	<p><b>LS – Link Status</b> – Link Status is ON when the unit is registering with the network and blinks when the unit is registered with the network.</p>
	Lights when DC power is applied to unit.

## Package Contents

- 1 MultiConnect Converter
- 1 antenna
- 1 RJ-11 cable

- 1 power supply
- 1 Quick Start Guide

**Notes:**

- If required, your wireless provider will supply the SIM card.
- If you are mounting the unit to a flat surface, you must supply the mounting screws.

## Specifications

### MT200A2W-G

Category	Description
Standard	GPRS; Class 10
Band, Frequency	Quad-band GSM 850/900/1800/1900 MHz
Packet Data	Up to 85.6K bps Coding Scheme CS1-4
Circuit-Switched Data	Up to 14.4K bps, non-transparent
Data Format	For serial interface – Asynchronous, 8-N-1, fixed 115Kbps
Flow Control	Hardware flow control
Antenna Connector	RF Antenna: 50 ohm SMA (female connector)
SIM Connector	Standard 1.8 and 3V SIM receptacle
Serial Command Port	Fixed @ 115200bps
Analog Connection	Supports connection speeds up to 33600bps (V34)
Command Connector	DE9 (female connector)
Dial Connector	RJ11
Antenna Connector	RF Antenna: SMA (female connector). Refer to Antenna Specifications.
Power Connector	2.5mm miniature screw-on
Voltage Range	9V to 32V @ 400mA
Dimensions	4.75" W x 1.58"H x 2.89"D 5.2oz 12.06cmW x 4.01cmH x 7.34cmD 0.147Kg
Operating Temperature <sup>1</sup>	-40° C to +85° C UL listed @ +40° C
Storage Temperature	-40° C to +85° C
Humidity	Relative humidity 20% to 90% noncondensing
EMC Compliance	FCC Part 15 Class B EN55022 Class B EN55024
Radio Compliance	FCC Part 22, 24 RSS132,133 EN301 489-1 EN301 489-7 EN301 511 AS/ACIF S042.1, S042.3
Safety	UL60950-1, 2 <sup>nd</sup> Edition cUL60950-1, 2 <sup>nd</sup> Edition IEC60950-1, 2 <sup>nd</sup> Edition
Network	PTCRB

<sup>1</sup> UL Listed at 40° C, limited by power supply. UL Certification does not apply or extend to an ambient above 40° C and has not been evaluated by UL for ambient greater than 40° C. “UL has evaluated this device for use in ordinary locations only. Installation in a vehicle or other outdoor locations has not been evaluated by UL. UL Certification does not apply or extend to use in vehicles or outdoor applications or in ambient above 40° C.”

Optional power must be UL Listed ITE power supply marked LPS or Class 2 rated 9-32Vdc, 1.44 – 0.4A

Répertorié UL à 40° C, limitée par la puissance d'alimentation. Certification UL ne s'appliquent ni s'étendre à l'une température ambiante supérieure à 40° C et n'a pas été évalué par UL pour ambiante supérieure à 40° C. «UL a évalué cet appareil pour une utilisation dans des endroits ordinaires seulement. Installation dans un véhicule ou d'autres emplacements en plein air n'a pas été évaluée par UL. La certification UL ne s'applique pas ou s'étendre à utiliser dans des véhicules ou les applications en extérieur ou dans ambiante dépasse 40° C.»

Alimentation en option doit être UL alimentation ITE marquée LPS ou classe 2 classé 9-32Vdc, 1,44 - 0,4 A

## MT200A2W-C1

Category	Description
Standard	CDMA2000 1xRTT
Band, Frequency	Dual-band 800/1900 MHz bands with Receive Diversity support on both bands
Packet Data	Up to 153K bps, forward and reverse
Data Format	For serial interface – Asynchronous, 8-N-1, fixed 115Kbps
Flow Control	Hardware flow control
Antenna Connector	RF Antenna: 50 ohm SMA (female connector)
Serial Command Port	Fixed @ 115200bps
Analog Connection	Supports connection speeds up to 33600bps (V34)
Command Connector	DE9 (female connector)
Dial Connector	RJ11
Antenna Connector	RF Antenna: SMA (female connector). Refer to Antenna Specifications.
Power Connector	2.5mm miniature screw-on
Voltage Range	9V to 32V @ 400mA
Dimensions	4.75" W x 1.58" H x 2.89" D 5.2oz 12.06cmW x 4.01cmH x 7.34cmD 0.147Kg
Operating Temperature <sup>1</sup>	-40° C to +85° C UL listed @ +40° C
Storage Temperature	-40° C to +85° C
Humidity	Relative humidity 20% to 90% noncondensing
EMC Compliance	FCC Part 15 Class B
Radio Compliance	FCC Part 22, 24
Safety	UL60950-1, 2 <sup>nd</sup> Edition IEC60950-1:2005 (Second Edition with EN 60950-1:2006+A11:2009)
Network	CDG 1&2

<sup>1</sup> UL Listed at 40° C, limited by power supply. UL Certification does not apply or extend to an ambient above 40° C and has not been evaluated by UL for ambient greater than 40° C. “UL has evaluated this device for use in ordinary locations only. Installation in a vehicle or other outdoor locations has not been evaluated by UL. UL Certification does not apply or extend to use in vehicles or outdoor applications or in ambient above 40° C.”

Optional power must be UL Listed ITE power supply marked LPS or Class 2 rated 9-32Vdc, 1.44 – 0.4A

Répertorié UL à 40° C, limitée par la puissance d'alimentation. Certification UL ne s'appliquent ni s'étendre à l'une température ambiante supérieure à 40° C et n'a pas été évalué par UL pour ambiante supérieure à 40° C. «UL a évalué cet appareil pour une utilisation dans des endroits ordinaires seulement. Installation dans un véhicule ou

d'autres emplacements en plein air n'a pas été évaluée par UL. La certification UL ne s'applique pas ou s'étend à utiliser dans des véhicules ou les applications en extérieur ou dans ambiante dépasse 40 ° C.»

Alimentation en option doit être UL alimentation ITE marquée LPS ou classe 2 classé 9-32Vdc, 1,44 - 0,4 A

**MT200A2W-H5**

Category	Description
Standard	High Speed Packet Access (HSPA+)
Band, Frequency	Refer to the following Frequency Bands table for details.
Data Speed	HSPA+ data service of up to 21.0 Mbps HSUPA data service of up to 5.76 Mbps
Data Format	For serial interface -- Asynchronous, 8-n-1, fixed 115Kbps
Flow Control	Hardware flow control
Antenna Connector	RF Antenna: SMA (female connector). Refer to Antenna Specifications
Serial Command Port	Fixed @115200bps
Analog Connection	Supports connections speeds up to 33600bps (V34)
Command Connector	DE9 (female connector)
Dial Connector	RJ11
Power Connector	2.5mm miniature screw-on
Voltage Range	9V to 32V @400mA
Dimensions	4.75" W x 1.58"H x 2.89"D 5.2oz 12.06cmW x 4.01cmH x 7.34cmD 0.147Kg
Operating Temperature <sup>1</sup>	-40° C to +85° C UL listed at +40° C
Storage Temperature	-40° to +85° C
Humidity	20% to 90% non-condensing
EMC Compliance	FCC Part 15 Class B EN 55022 Class B EN 55024
Radio Compliance	FCC Part 22      FCC Part 24      FCC Part 27 RSS 132          RSS 133          RSS 139 EN301 511      CE RED Radio/SAR EN301 489-1    EN301 489-52
Safety	UL 60950-1 cUL 60950-1 EN 60950-1 AS/NZ 60950-1
Network	PTCRB AT&T Others pending

<sup>1</sup> UL Listed at 40° C, limited by power supply. UL Certification does not apply or extend to an ambient above 40° C and has not been evaluated by UL for ambient greater than 40° C. "UL has evaluated this device for use in ordinary locations only. Installation in a vehicle or other outdoor locations has not been evaluated by UL. UL Certification does not apply or extend to use in vehicles or outdoor applications or in ambient above 40° C."

Optional power must be UL Listed ITE power supply marked LPS or Class 2 rated 9-32Vdc, 1.44 – 0.4A

Répertorié UL à 40° C, limitée par la puissance d'alimentation. Certification UL ne s'appliquent ni s'étendre à l'une température ambiante supérieure à 40° C et n'a pas été évalué par UL pour ambiante supérieure à 40° C. «UL a évalué cet appareil pour une utilisation dans des endroits ordinaires seulement. Installation dans un véhicule ou d'autres emplacements en plein air n'a pas été évaluée par UL. La certification UL ne s'applique pas ou s'étendre à utiliser dans des véhicules ou les applications en extérieur ou dans ambiante dépasse 40° C.»

Alimentation en option doit être UL alimentation ITE marquée LPS ou classe 2 classé 9-32Vdc, 1,44 - 0,4 A

**Note:** Radio performance may be affected by temperature extremes.

## Frequency Bands

Mode	Freq. TX (MHz)	Freq. RX (MHz)	Channels	TX - RX offset
GSM850	824.2 - 848.8	869.2 - 893.8	128 - 251	45 MHz
EGSM900	890.0 - 914.8	935.0 - 959.8	0 - 124	45 MHz
	880.2 - 889.8	925.2 - 934.8	975 - 1023	45 MHz
DCS1800	1710.2 - 1784.8	1805.2 - 1879.8	512 - 885	95MHz
PCS1900	1850.2 - 1909.8	1930.2 - 1989.8	512 - 810	80MHz
WCDMA850 (band V)	826.4 - 846.6	871.4 - 891.6	Tx: 4132 - 4233 Rx: 4357 - 4458	45MHz
WCDMA900 (band VIII)	882.4 - 912.6	927.4 - 957.6	Tx: 2712 - 2863 Rx: 2937 - 3088	45MHz
WCDMA1700 (band IV)	1710.4 - 1755.6	2112.4 - 2167.6	Tx : 1312 – 1513 Rx: 9662 - 9938	400MHz
WCDMA1900 (band II)	1852.4 – 1907.6	1932.4 – 1987.6	Tx : 9262 – 9538 Rx : 9662 - 9938	80MHz
WCDMA2100 (band I)	1922.4 – 1977.6	2112.4 – 2167.6	Tx : 9612 – 9888 Rx : 10562 - 10838	190MHz

## HE910 Telit Transmission Output Power

Band	Power Class
GSM 850/900	4 (2W)
DCS1800/PCS1900	1 (1W)
EDGE, 850/900 MHz	E2 (0.5W)
EDGE, 1800/1900 MHz	Class E2 (0.4W)
WCDMA 850/900, AWS 1700, 1900/2100 MHz	Class 3 (0.25W)



## Power

Multi-Tech Systems, Inc. recommends that you incorporate a 10% buffer into your power source when determining product load.

### Power draw for MT200A2W-G

Input Voltage= 9.0Volts	Sleep Mode	Typical	Maximum	Peak Tx	Peak Rst (Inrush)
GSM850	9.26	9.25	9.24		
Current(AMPS)	0.111	0.172	0.254	1.43	
Watts	1.03	1.59	2.35		
Inrush Current (AMPS) (approx. 8ms duration)					1.20
Input Voltage= 16.0 Volts	Sleep Mode	Typical	Maximum	Peak Tx	Peak Rst (Inrush)
GSM850	16.00	16.00	16.00		
Current(AMPS)	0.068	0.105	0.151	0.745	
Watts	1.09	1.68	2.42		
Inrush Current (AMPS) (approx. 8ms duration)					1.56

### Power Draw for the MT200A2W-H5 (GSM850/HSDPA)

#### GSM850

Input Voltage =9V	Sleep Mode	Idle	Typical	Peak Tx	Peak Rst (Inrush)
Current (A)	0	0.125	0.234	1.51	2.560
Watts	0	1.13	2.11		
Input Voltage =16V	Sleep Mode	Idle	Typical	Peak Tx	Peak Rst (Inrush)
Current (A)	0	0.074	0.137	0.715	2.120
Watts	0	1.18	2.19		

#### HSDPA

Input Voltage =9V	Sleep Mode	Idle	Typical	Peak Tx	Peak Rst (Inrush)
Current (A)	0	0.129	0.261	0.34	2.560
Watts	0	1.16	2.35		
Input Voltage =16V	Sleep Mode	Idle	Typical	Peak Tx	Peak Rst (Inrush)
Current (A)	0	0.074	0.137	0.440	2.120
Watts	0	1.18	2.19		

#### Notes for models G2 and H5

- **Peak Tx:** The peak current during maximum data transmission.
- **Typical:** The average current during maximum data transmission.
- **Inrush Current:** The input current during power up, or a reset.

## Power Draw for the MT200A2W-C1

### US CELLULAR 800 MHz

Input Voltage =9V	Sleep Mode	Typical	Maximum	Peak Tx	Peak Rst (Inrush)
Current (A)	0.110	0.190	0.410	0.590	0.455
Watts	1.019	1.76	3.76		
Input Voltage =20V	Sleep Mode	Typical	Maximum	Peak Tx	Peak Rst (Inrush)
Current (A)	0.055	0.100	0.200	0.330	0.665
Watts	1.10	2.00	4.00		
Input Voltage =32V	Sleep Mode	Typical	Maximum	Peak Tx	Peak Rst (Inrush)
Current (A)	0.040	0.065	0.135	0.235	0.520
Watts	1.280	2.08	4.32		

### US PCS 1900MHz

Input Voltage =9V	Sleep Mode	Typical	Maximum	Peak Tx	Peak Rst (Inrush)
Current (A)	0.110	0.194	0.510	0.695	0.455
Watts	1.019	1.79	4.68		
Input Voltage =20V	Sleep Mode	Typical	Maximum	Peak Tx	Peak Rst (Inrush)
Current (A)	0.055	0.110	0.245	0.372	0.665
Watts	1.10	2.20	4.90		
Input Voltage =32V	Sleep Mode	Typical	Maximum	Peak Tx	Peak Rst (Inrush)
Current (A)	0.040	0.065	0.160	0.276	0.520
Watts	1.280	2.08	5.12		

#### Notes for model C1

- Peak Tx: The peak current during transmission burst period.
- Maximum: The continuous current during maximum data rate with the radio transmitter at maximum power.
- Inrush Current: The input current during power up, or a reset.

## Cellular Information

### Antenna System for Cellular Devices

The cellular/wireless performance is completely dependent on the implementation and antenna design. The integration of the antenna system into the product is a critical part of the design process; therefore, it is essential to consider it early so the performance is not compromised. If changes are made to the certified antenna system of the MultiConnect then recertification will be required by specific network carriers such as Sprint. The Antenna System is defined as the UFL connection point from the MultiConnect to the specified cable specifications and specified antenna specifications.

## PTCRB Requirements for the Antenna

There cannot be any alteration to the authorized antenna system. The antenna system must maintain the same specifications. The antenna must be the same type, with similar in-band and out-of-band radiation patterns.

## FCC Requirements for the Antenna

The antenna gain, including cable loss, for the radio you are incorporating into your product design must not exceed the requirements at 850 MHz and 1900 MHz as specified by the FCC grant for mobile operations and fixed mounted operations as defined in 2.1091 and 1.1307 of the FCC rules for satisfying RF exposure compliance. The antenna used for transmitting must be installed to provide a separation distance of at least 20cm from all persons and must not transmit simultaneously with any other antenna transmitters. User and installers must be provided with antenna installation instructions and transmitter operating conditions to satisfying RF exposure compliance.

## Antenna Specifications

### HSPA+ Antenna Requirements/Specifications

Frequency Range	824 – 960 MHz / 1710 – 1990 MHz / 1920 – 2170 MHz	
Impedance	50 Ohms	
VSWR	VSWR should not exceed 2.0:1 at any point across the bands of operation	
Typical Radiated Gain	3.17 dBi	3.17 dBi
	950 MHz 3.51 dBi	950 MHz 3.51 dBi
	1800 MHz 3.55 dBi	1800 MHz 3.55 dBi
	1900 MHz 3.0 dBi	1900 MHz 3.0 dBi
	2100 MHz 3.93 dBi	2100 MHz 3.93 dBi
	3.17 dBi	3.17 dBi
Radiation	Omni-directional	
Polarization	Vertical	

### CDMA Antenna Requirements/Specifications

Frequency Range	824 – 894 MHz / 1850 – 1990 MHz
Impedance	50 Ohms
VSWR	VSWR shall not exceed 2.0:1 at any point across the bands of operation
Typical Radiated Gain	2 dBi on azimuth plane
Radiation	Omni-directional
Polarization	Vertical
TRP/TIS	The total radiated power (TRP) at the antenna shall be no less than +21/20 dBm for PCS/CELL channels respectively, and the total isotropic sensitivity (TIS) at the antenna shall be no less than -104/104 dBm for PCS/CELL channels respectively.

### GSM Antenna Requirements/Specifications

Frequency Range	824 – 960 MHz / 1710 – 1990 MHz
Impedance	50 Ohms
VSWR	VSWR shall not exceed 2.0:1 at any point across the bands of operation
Typical Radiated Gain	2 dBi on azimuth plane
Radiation	Omni-directional

Polarization	Vertical
TRP/TIS	Including cable loss the total radiated power (TRP) at the antenna shall be no less than +22/24.5 dBm for 850/1900 MHz respectively, and the total isotropic sensitivity (TIS) at the antenna shall be no less than -99/101.5 dBm for 850/1900 MHz respectively.

## Command Connector

The following table explains the pin functions.

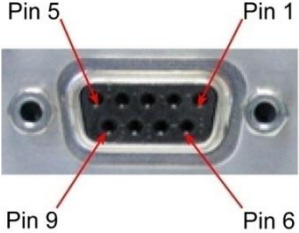
External Power		Command Connector (DE-9 - Female)
Signal	IN/OUT	
Pin 1 CD	N/A	 <p>Pin 5</p> <p>Pin 1</p> <p>Pin 9</p> <p>Pin 6</p>
Pin 2 RX	O	
Pin 3 TX	I	
Pin 4 DTR	N/A	
Pin 5 GND	GND	
Pin 6 DSR	N/A	
Pin 7 RTS	I	
Pin 8 CTS	O	
Pin 9 RI	N/A	

## Chapter 2 – Installation

### Account Activation for Wireless Devices

Please refer to Multi-Tech's Cellular Activation Web site at <http://www.multitech.com/activation.go> for information on activating your cellular modem. On the Cellular Activation Web site, click the down arrow in Select Your Product and select the desired model of MT200A2W from the pull down listing.

### Insert the SIM Card into Holder

This section applies to models MT200A2W-G and MT200A2W-H5.

The MultiConnect requires the power supply connection to begin operation. It also requires a SIM card (Subscriber Identity Module) in the unit to operate on a GPRS/GSM and HSPA+ network. To install the SIM, perform the following procedure:

1. Before changing a SIM, ensure that power is removed from the unit.
2. Open the SIM door by pressing down on the tab on the top of the door and prying open the door.



3. Insert the SIM card into the card holder. The above graphic illustrates the correct SIM card orientation.
4. Verify that the SIM card fits into the holder properly and then close the door.

### Connect the Antenna, Serial and Modem Cables, and Power



#### Dial Port Caution



The dial port **is not** designed to be connected to a Public Telecommunications Network (PSTN/phone line) or used outside the building.

#### Composez Port Attention

Le cadran port n'est pas conçu pour être connecté à un réseau de télécommunication publique (PSTN / de ligne téléphonique) ou utilisé à l'extérieur du bâtiment.

1. Connect the antenna to the ANT connector on the back of the unit and tighten by hand.  
**WARNING:** Using a wrench to tighten the antenna or tightening the antenna above 7 inch-pounds may cause the connector to spin, which can cause the solder connection between the coax and connector to fail.
2. Connect the DE9 connector (9-pin) of the RS232 cable to the COMMAND connector on the unit and connect the other end to serial port on your PC.
3. Connect the RJ11 phone cable to the DIAL connector on the unit and connect the other end of the phone cable to the analog modem.
4. Remove the protective shipping cover. Attach the appropriate input connector to the power supply device by holding down on the slide lock and tipping the input connector to fit into the notch on top of the device and then lowering it into the slide lock. Then release the slide lock.

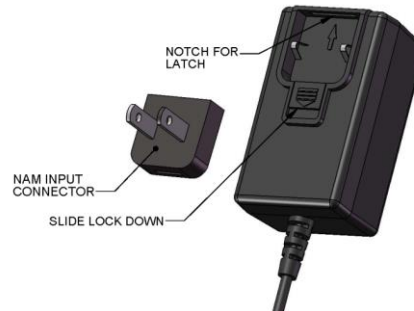

5. Screw on the power lead from the power supply device to the power connection on the unit. Now, plug the power supply into your power source.

**Note:** If desired you can press the Reset button to reset the hardware.

## Optional – Attach the Modem to a Flat Surface

The modem can be panel mounted with screws spaced according to the measurement shown.

**Note:** Use a #6 pan head screws for all mount locations.

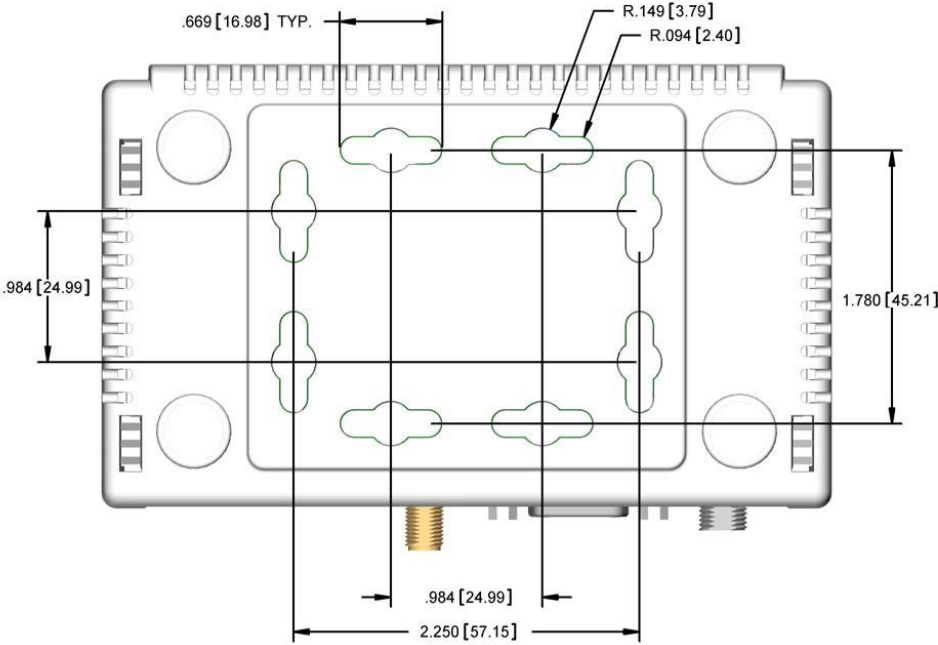

ALL DIMENSION IN INCHES [mm]

# Chapter 3 – Configuring Ports

Before you start configuring your MultiConnect unit, establish a wireless network account. Then, log into your MultiConnect unit using either HyperTerminal or an equivalent terminal emulation program.

## Connecting to the Device

The following configuration procedures use the Windows XP Operating System. Older Windows versions have similar paths to HyperTerminal.

Windows Vista and newer Windows versions do not include HyperTerminal. If you are using one of these, download a terminal emulator program to communicate with your MultiConnect unit.

1. Go to **Start | All Programs | Accessories | Communications** and click **HyperTerminal**. The Connection window displays.
2. Enter a name for the connection.



3. Click **OK**. The Connect To screen appears with Country/region, Area code, and Phone number grayed out.



4. Select the MultiConnect's COM port from the **Connect using** drop down list. The COM Properties screen displays.



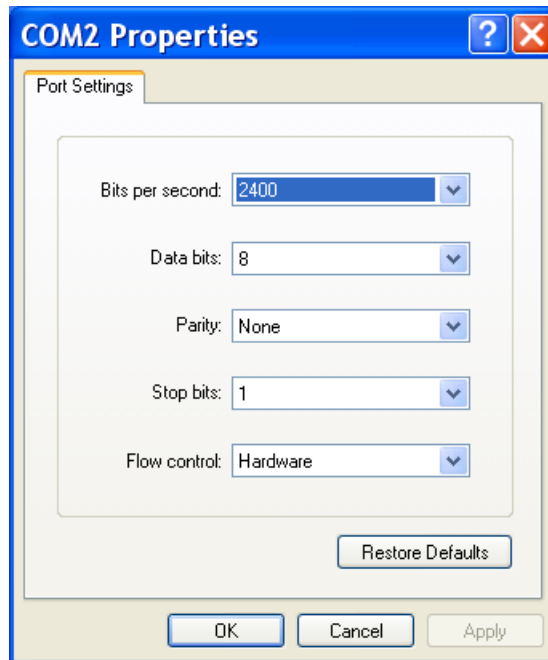

5. Change the **Bits per second** to **115200**.
6. Click **Apply** and then click **OK**.
7. Press **ENTER**.

## Logging In

The Login screen displays.



1. Enter the default password, **admin**. The Introduction Menu displays and prompts **What would you like this port to do?**
2. Enter **A** to select Display Main Menu (Configuration options).

## Configuring the Port

When you use a terminal emulation program to connect to your MultiConnect, it detects the unit's configuration. The analog (PSTN) port menu defaults to a typical configuration.

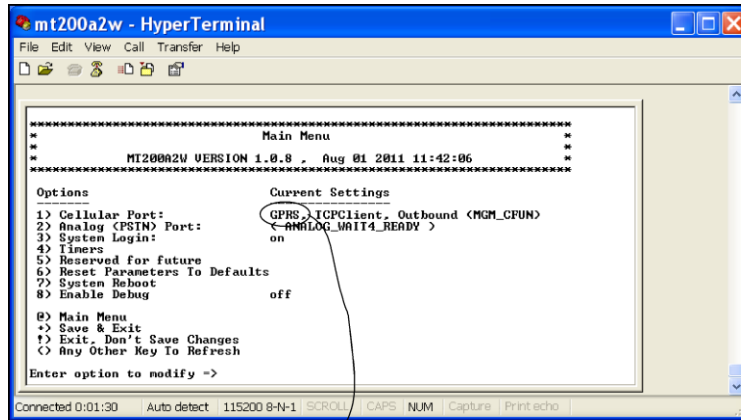

*Example of a MT200A2W Main Menu.  
For a MT200A2W-C1 Main Menu, this would show CDMA.*

For the MT200A2W-G and MT200A2W-H5 use either the default GPRS or select GSM port configuration. For the MT200A2W-C1, CDMA is the only port configuration option.

## GPRS Cellular Port Configuration

1. Enter **1** for Cellular Port. GPRS is the default.

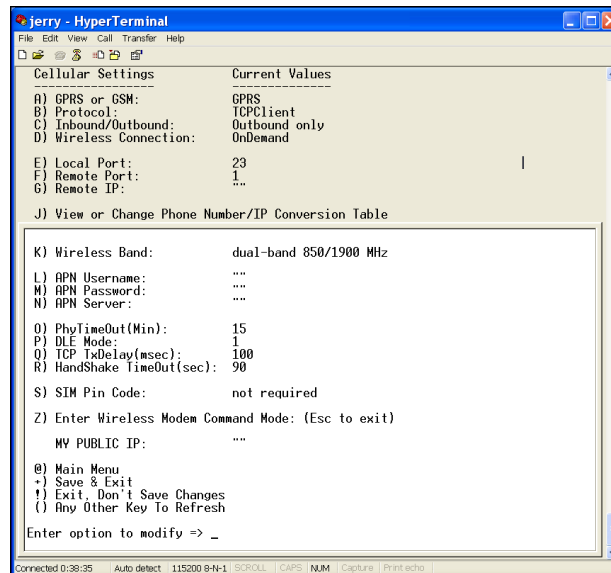

2. Set the port options as described in GPRS Port Options.
3. Save your configuration by entering a + at the prompt. Return to the Main Menu and wait for the cellular wireless network and the analog modem to change to a READY state. The Current Settings will change to: (WIRELESS\_READY) (ANALOG\_READY).

## GPRS Port Options

GPRS Network Dependent		
Option	Default	Description
B) Protocol	TCPClient	Select either TCPClient, Telnet, UDP, or PasThru
C) Inbound or Outbound	Outbound only	No selection.
D) Wireless Connection	On Demand	Select either On Demand or Always On. <b>Note:</b> If you want Always On, do not select this option until you finish making other configuration changes.
Port Dependent		
Option	Default	Description
<b>Note:</b> When you change the Remote Port or Remote IP, they become the default without pressing the + key to save the configuration.		
F) Remote Port	1	TCP/IP port that remote device is listening on.
G) Remote IP	None	IP address of remote device on the network you are connecting to.
Wireless Band		
Option	Default	Description
<b>Note:</b> The Wireless Band is set depending on the region of the world the unit is set up for, e.g., 850/1900MHz for NAM.		
K) Wireless Band	Dual-band 850-1900 MHz	This option is default depending on the region of the world the unit is set up for, e.g., 900/1800MHz for Europe. 0) dual-band 850/1900 MHz 1) dual-band 900/1800 MHz
APN Dependent		
Option	Default	Description
<b>Note:</b> Configure options L thru N based on your Access Point Name (APN) Server requirements.		
L) APN User Name		The user name may not be required by all network providers.
M) APN Password		The password may not be required by all network providers.
N) APN Server		The APN assigned by your cellular network provider.
MultiConnect AW Security		
Option	Default	Description
<b>Note:</b> If required by wireless provider, enter SIM pin code.		
S) SIM Pin Code	Not required	If enabled, select option 2 and enter your pin code. The pin code is four to eight digit number. <b>Note:</b> After 3 unsuccessful attempts to enter the PIN, the PUK (Personal Unblocking Key) is required.

## GSM Cellular Port Configuration

1. Enter **1** for Cellular Port. GPRS is the default.

2. Enter **2** for GSM. The GSM Cellular Port menu displays.

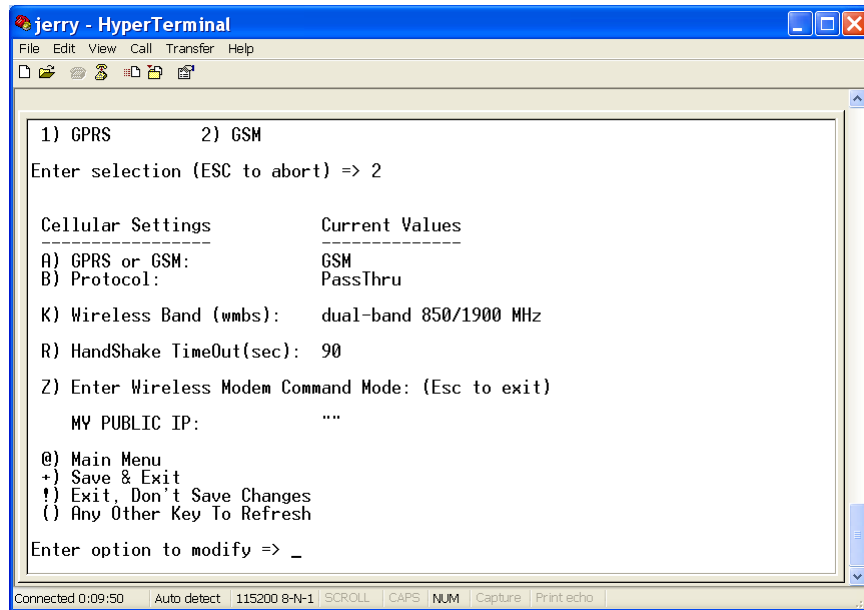

3. Set the port options as described in GSM Port Options.
4. Save your configuration by entering a **+** at the prompt. Return to the Main Menu and wait for the cellular wireless network and the analog modem to change to a READY state. The Current Settings will change to: (WIRELESS\_READY) (ANALOG\_READY).

### GSM Port Options

GSM network Dependent		
Option	Default	Selection
A) GPRS or GSM	GPRS	Select GSM
B) Protocol	Pass Thru	No selection
K) Wireless Band	Dual-band 850/1900 MHz	This option is default depending on the region of the world the unit is set up for, e.g., 850/1900MHz for NAM. 0) dual-band 850/1900 MHz 1) dual-band 900/1800 Mhz

## CDMA Cellular Port Configuration

1. Enter **1** for Cellular Port. CDMA is the default for the MT200A2W-C1, so the CDMA Cellular Port menu displays.

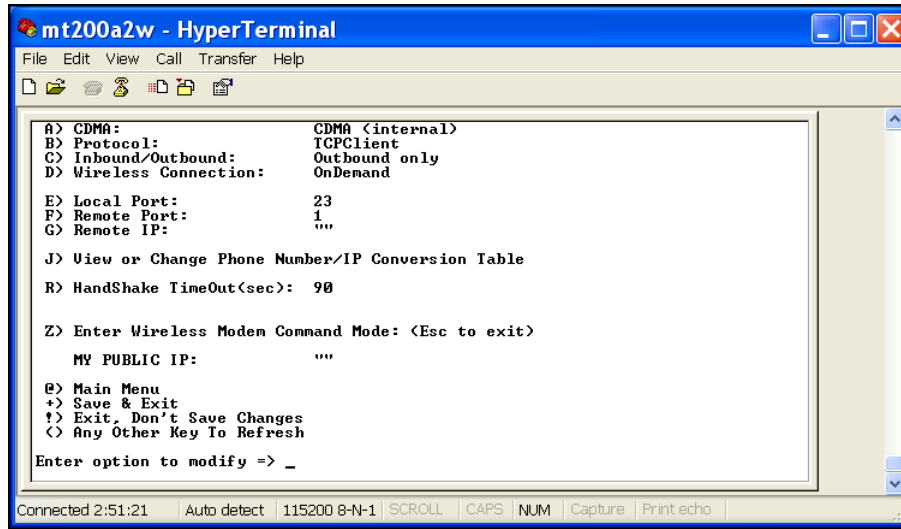

2. Set the port options as described in CDMA Port Options.
3. Save your configuration by entering a **+** at the prompt. Return to the Main Menu and wait for the cellular wireless network and the analog modem to change to a READY state. The Current Settings will change to: (WIRELESS\_READY) (ANALOG\_READY).

### CDMA Port Options

CDMA network Dependent		
Option	Default	Selection
B) Protocol	TCPClient	Select either TCPClient, Telnet, UDP, or PassThru
Port Dependent		
Option	Default	Description
<b>Note:</b> These options depend on your local/remote port.		
F) Remote Port	1	The TCP/IP port that the remote device is listening on.
G) Remote IP	None	The IP address of the remote device on the network you are going to.

# Chapter 4 – Device Configuration

## Introduction Menu

Use Introduction Menu to configure your device, upgrade firmware within the device, or develop a script to automatically configure multiple devices. Options are:

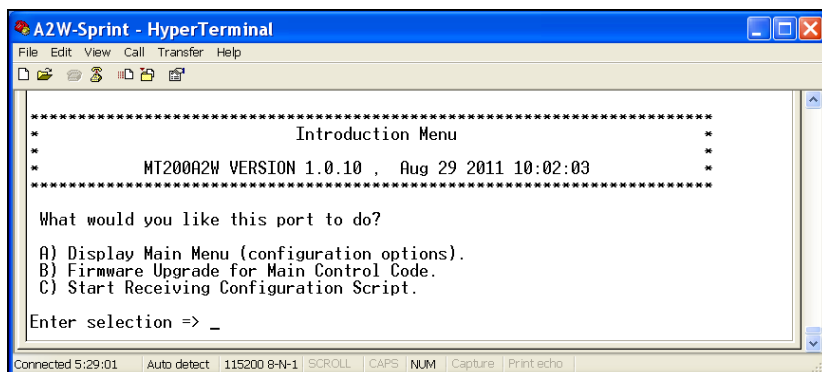

```
A2W-Sprint - HyperTerminal
File Edit View Call Transfer Help
*****
*                               *
*           Introduction Menu     *
*                               *
*   MT200A2W VERSION 1.0.10 , Aug 29 2011 10:02:03   *
*                               *
*****
What would you like this port to do?

A) Display Main Menu (configuration options).
B) Firmware Upgrade for Main Control Code.
C) Start Receiving Configuration Script.

Enter selection => _
```

- **A) Display Main Menu (configuration options)** which allows you to configure the MultiConnect. Refer to Device Configuration in this chapter.
- **B) Firmware Upgrade for Main Control Code.** Refer to Chapter 5 for firmware upgrade procedures.
- **C) Start Receiving Configuration Script** to automatically configure a device. Refer to Chapter 6 for a configuration script example.



## GPRS Cellular Port Configuration

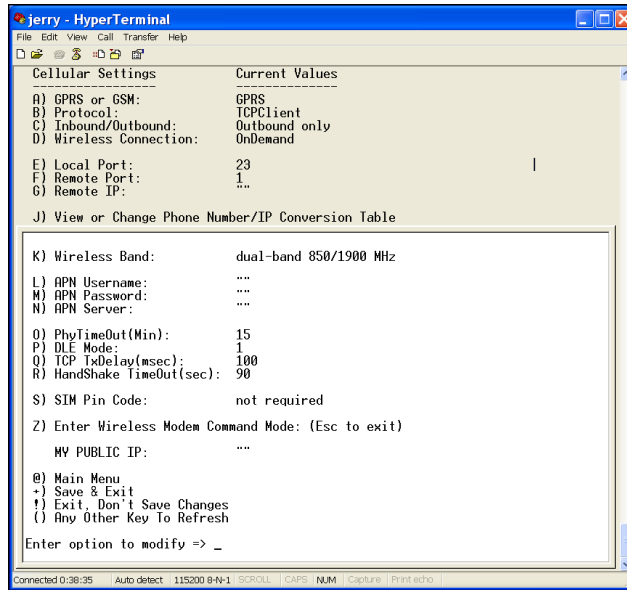

Network Dependent		
Option	Default	Description
A) GPRS or GSM	GPRS	The GPRS or GSM option is based on the SIM installed in the unit. <b>1) GPRS</b> option requires a packet switched cellular network. <b>2) GSM</b> option requires circuit switch cellular network. If you select GSM, skip to GSM Cellular Port Configuration for configuration information.
B) Protocol	TCP Client	<b>1) TCP Client</b> option is an internet protocol intended to get data from one network device to another. <b>2) Telnet</b> option is a client communication. <b>3) UDP</b> option is a connectionless protocol in that UDP makes no provision for acknowledgement of packets received. <b>4) Pass Thru</b> option allows for data to be transferred from a legacy device to a remote destination without being modified.
Option	Default	Description
C) Inbound/Outbound	Outbound only	This option defaults to Outbound and there are no additional selections.
D) Wireless Connection	On Demand	<b>1) On-Demand</b> option initiates the wireless connection when a request made. <b>2) Always On</b> option is always connected to the cellular network. <b>Note:</b> If you want Always On, do not select this option until you finish making other configuration changes.
Port Dependent		
Option	Default	Description
E) Local Port	23	Not applicable.



F) Remote Port	1	<b>Remote Port</b> is the IP port that the remote device listens on. When you change the Remote Port, it becomes the new default port.
G) Remote IP	None	<b>Remote IP</b> is the IP address of the device you are connecting to for outbound. When you change the Remote IP, it becomes the new default IP.
<b>Phone Number/IP Conversion Table</b>		
<b>Option</b>	<b>Default</b>	<b>Selection</b>
J) View or change Phone Number/IP Conversion Table		This option allows for additional remote server IPs to be added to the Phone Number/ IP Conversion Table. When a dialed number matches one of those in this table, the default Remote Port and IP options are overridden during the call. If the entry does not match, the default is used. For detailed instructions on entering data in this table, refer to View or Change Phone Number/IP Conversion Table in this chapter.
<b>Wireless Band</b>		
<b>Option</b>	<b>Default</b>	<b>Selection</b>
K) Wireless Band	Dual-band 850/1900 MHz	This option is default depending on the region of the world the unit is set up for, e.g., 900/1800MHz for Europe. 0) dual-band 850/1900 MHz - NAM 1) dual-band 900/1800 MHz – Euro/ROW
<b>APN Dependent</b>		
<b>Option</b>	<b>Default</b>	<b>Selection</b>
The Access Point Name (APN) is the server name provided by your carrier. For example, AT&T; PROXY, INTERNET, or PUBLIC, T-Mobile; INTERNET2, VOICESTREAM.COM, INTERNET2, or WAP.VOICESTREAM.COM Rogers Wireless of Canada; INTERNET.COM		
L) APN Username		The APN User name is assigned by your cellular network provider for security and authentication purposes. The user name may not be required by all network providers.
<b>Option</b>	<b>Default</b>	<b>Selection</b>
M) APN Password		The APN Password is assigned by your cellular network provider for security and authentication purposes. The password may not be required by all network providers.
N) APN Server		The APN assigned by your cellular network provider.
<b>MultiConnect AW Security</b>		
<b>Option</b>	<b>Default</b>	<b>Selection</b>
O) PhyTimeout (Min)	15 Min	The Physical Time out option is a time limit in which the MultiConnect AW will drop the connection to the cellular network if no activity is sensed on the network. The range is zero to 255 minutes, with 0 disabling the time out. The default is 15 minutes. Normally, this option should be left in the default value.
P) DLE Mode	1	DLE Mode 0 is enabled, no specific process is needed on [ETX] characters. This means that is not possible for a host to request

		<p>an end of connection or to receive a clear indication of the end of a connection from the TCP/IP stack.</p> <p>DLE Mode 1 is enabled, the [ETX] characters means a request or an indication of end of connection. As a consequence, [ETX] characters that belong to the payload must be sent by the host on the serial port preceded by a DLE character. Similarly, ETX characters received by the TCP/IP stack from the Internet are sent to the host through the serial port preceded by a DLE character.</p>
Q) TCP TxDelay	100 milliseconds	This option determines the time delay introduced before sending a TCP frame that has not been entirely filled with user data. The time is entered in milliseconds, and it should be noted that a value of 0 initiates the sending of a TCP frame as soon as possible after the reception of a single character value from the host.
R) Handshake TimeOut (sec)	90 seconds	The handshake timeout is a wireless modem timeout of between 1 and 255 seconds. Default is 90 seconds.
S) SIM Pin Code	Not Required	<p>The default option (1) is the SIM pin code is not required. Option 2 is enter or change the pin code. The pin code is four to eight digit number.</p> <p><b>Note:</b> After 3 unsuccessful attempts to enter the PIN, the PUK (Personal Unblocking Key) will be required.</p>
Z) Enter Wireless Modem Command Mode		This option opens the command port on the wireless modem to enter AT commands.

## GSM Cellular Port Configuration

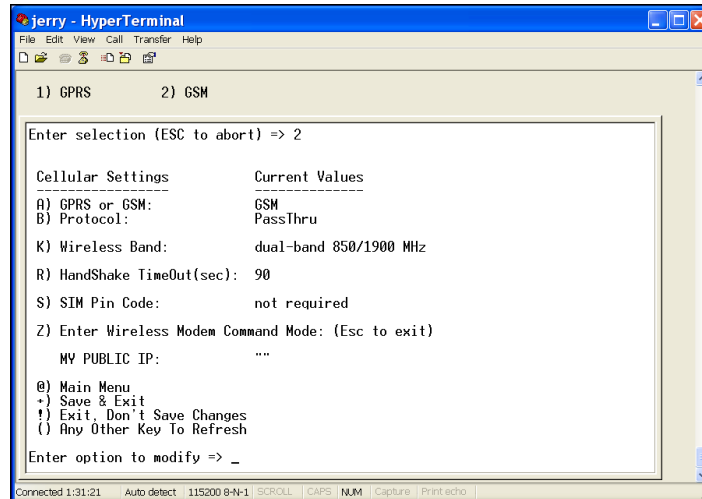

Network Dependent		
Option	Default	Description
A) GPRS or GSM	GPRS	The GPRS or GSM option is based on the SIM installed in the unit. <b>GSM</b> option requires a circuit switched cellular network.
B) Protocol	Pass Thru	This option defaults to Pass Thru and there are no additional selections.
Wireless Band		
Option	Default	Selection
K) Wireless Band	Dual-band 850/1900 MHz	This option is set depending on the region of the world the unit is set up for, e.g., 850/1900MHz for NAM. 0) dual-band 850/1900 MHz - NAM 1) dual-band 900/1800 MHz - Euro/ROW
MultiConnect AW Security		
Option	Default	Selection
R) Handshake TimeOut (sec)	90 seconds	The handshake timeout is a wireless modem timeout between 1 and 255 seconds.
S) SIM Pin Code	Not required	The default option (1) is the SIM pin code is not required.
Z) Enter Wireless Modem Command Mode		This option opens the command port on the wireless modem allowing you to enter AT commands.

## CDMA Cellular Port Configuration

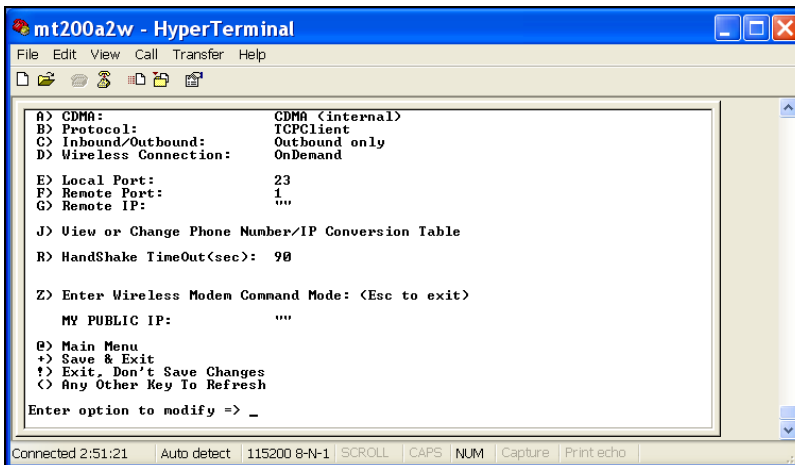

Network Dependent		
Option	Default	Description
A) CDMA	CDMA (Internal)	No selection
B) Protocol	TCPClient	<p><b>1) TCPClient</b> option is an internet protocol intended to get data from one network device to another.</p> <p><b>2) Telnet</b> option is a client communication.</p> <p><b>3) UDP</b> option is a connectionless protocol in that UDP makes no provision for acknowledgement of packets received.</p> <p><b>4) Pass Thru</b> option allows for data to be transferred from a legacy device to a remote destination without being modified.</p>
C) Inbound/Outbound	Outbound	No selection
D) Wireless Connection	OnDemand	<p><b>1) On-Demand</b> option initiates the wireless connection when a request made.</p> <p><b>2) Always On</b> option is always connected to the cellular network.</p> <p><b>Note:</b> If you want Always On, do not select this option until you finish making other configuration changes.</p>
Port Dependent		
Option	Default	Description
E) Local Port	23	<b>Local Port</b> is the port that the MultiConnect AW listens on for inbound traffic.
F) Remote Port	0	<b>Remote Port</b> is the IP port that the remote device listens on. When you change the Remote Port, it becomes the new default port.
G) Remote IP	none	<b>Remote IP</b> is the IP address of the device you are connecting to for outbound. When you change the Remote IP, it becomes the new default IP.
Phone Number/IP Conversion Table		
Option	Default	Selection

J) View or change Phone Number/IP Conversion Table		This option allows for additional connections to be added to the Phone Number/ IP Conversion Table.  When a dialed number matches one of those in this table, the default Remote Port and IP options are overridden during the call. If the entry does not match, the default is used. For detailed instructions on entering data in this table, refer to View or Change Phone Number/IP Conversion Table in this chapter.
<b>MultiConnect AW Security</b>		
<b>Option</b>	<b>Default</b>	<b>Selection</b>
R) Handshake TimeOut (sec)	90 seconds	The handshake timeout is a wireless modem timeout of between 1 and 255 seconds. Default is 90 seconds.
Z) Enter Wireless Modem Command Mode		This option opens the command port on the wireless modem to enter AT commands.

## View or Change Phone Number/IP Conversion Table

The Phone number/IP conversion table uses an analog (PSTN) phone number to look up a remote server's IP address. Phone number/IP conversion table holds up to 5 entries. When a dialed number matches a number in the table, the default Report Port and Remote IP are overridden for this call.

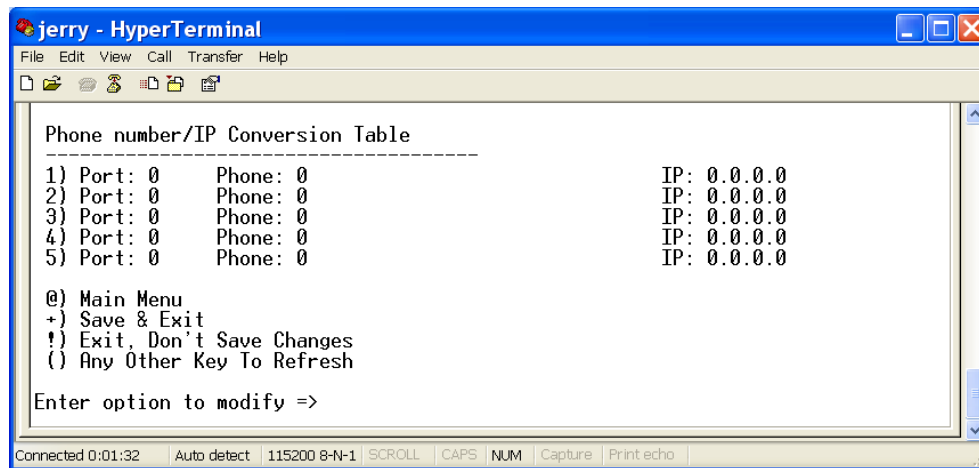

To set up the conversion table:

1. If you are still on the Main Menu, enter **J** to go to the Phone number/IP Conversion Table.
2. Enter number for the entry you want to change.
3. Enter a Server Port Number.
4. Enter the **Server Phone Number** without dashes between the area code, exchange, and extension number.
5. For Server IP, enter the IP address of the server on your cellular network.
6. You do not have to enter + to save these changes.

## Analog (PSTN) Port Configuration

The default settings in the Analog (PSTN) Port Configuration are typically the correct ones.

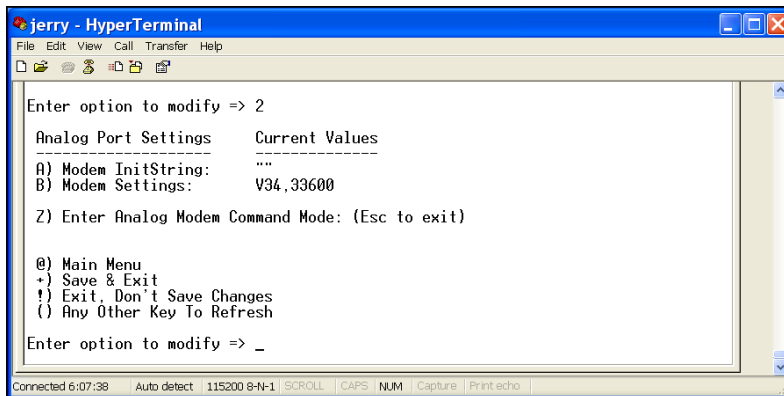

Option	Default	Description
Modem Initialization String	“ ”	Allows you to enter initialization commands into the internal analog modem.
Modem Settings	V34,33600	Allows you to reconfigure the internal analog modem. Select this option to change baud rate, flow control, etc. See PSTN Modem Settings.

## PSTN Modem Settings

Use the PSTN Modem Settings menu to reconfigure analog modem.

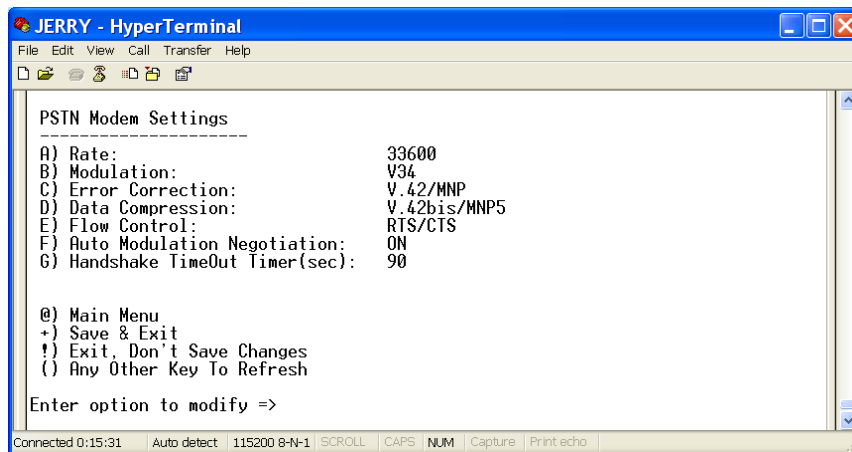

Option	Default	Description/Options
A) Rate	33600	The analog modem’s maximum speed. Options are: A) 56000 B) 33600 C) 28800 D) 14400 E) 12000 F) 9600 G) 4800 H) 2400 I) 2200 J) 1200 K)300.
B) Modulation	V34	Options are: A) V92 B) V90 C) V34 D) V32bis E) V32 F) V22bis G) V22 H) BELL212A I) BELL103.
C) Error Correction	V.42/MNP	Options are: A) V.42/MNP B) V.42 Only C) MNP Only D) Direct Mode E) NoECM.
D) Data Compression	V.42bis/MNP5	Options are: A) Enable V.42bis/MNP5 Data Compression B) Disable Data Compression.

Option	Default	Description/Options
E) Flow Control	RTS/CTS	Options are: A) RTS/CTS B) XON/XOFF C) Disable
F) Auto Modulation Negotiation	ON	Options are: A) ON or B) OFF
G) Handshake TimeOut Timer (sec)	90	Enter a value from 0 to 255 seconds. Zero disables the timer.

## System Login

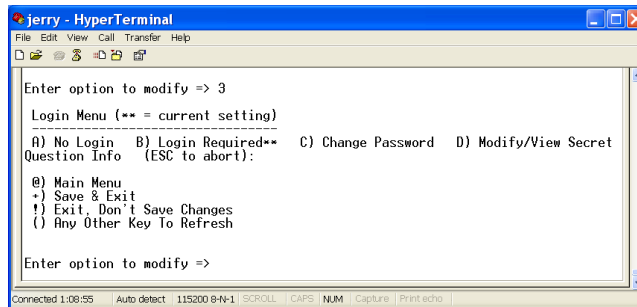

Option	Description
A) No Login	Allows access to the MultiConnect without a login.
B) Login Required	Requires a user to login.
C) Change Password	Select to change the password. The default password is admin all lower case letters.
D) Modify/View Secret Question Info	Adds secret question and answer to be used when a user forgets the password.

## Setting up a Secret Question

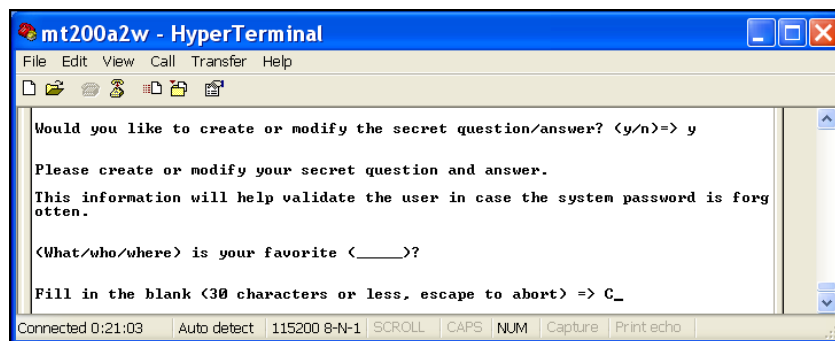

From the System Login page:

1. Enter **D**.
2. Select **Y** to create or modify the secret question/answer.
3. To fill in the blank for <What/who/where> is your favorite <\_\_\_\_>, enter up to 30 characters to define your favorite category, for example, teacher or car.
4. Enter an answer to the question, up to 30 characters.
5. Enter **+** to save your secret and exit.

# Timers

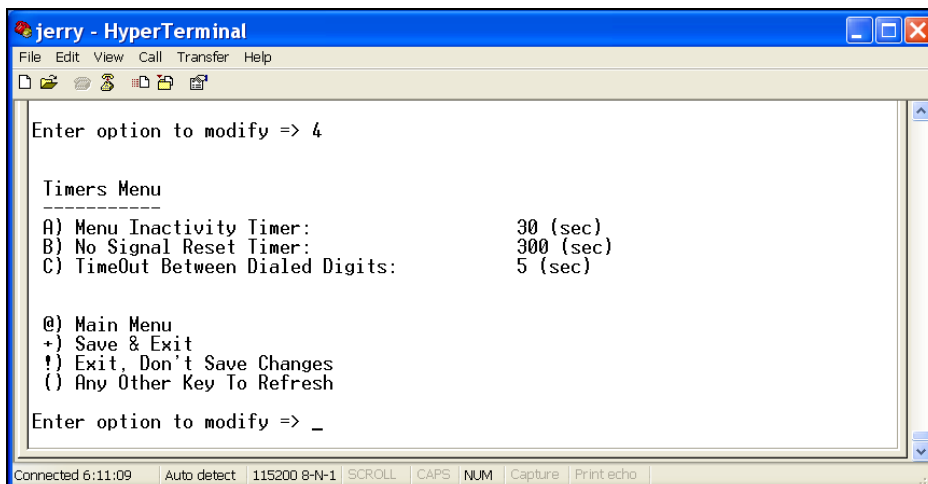

Option	Default	Description
A) Menu Inactivity Timer	30 (sec)	Enter, in seconds, how long a menu displays with no activity. Zero disables the timer.
B) No Signal Reset Timer	300 (sec)	Use this timer to reset the device if it cannot find a signal strong enough to establish a wireless connection. Enter the number of seconds to attempt a wireless connection. Zero disables the timer.
C) TimeOut Between Dialed Digits	5 (sec)	Use this timer to set the maximum time allowed between dialing two digits before the device assumes that dialing is complete. When the timer expires, device attempts the call. For example, if the timer is set to 5 seconds, when 5 seconds has elapsed the device assumes you finished entering the phone number and attempts to place the call.

# Reset Parameters to Defaults

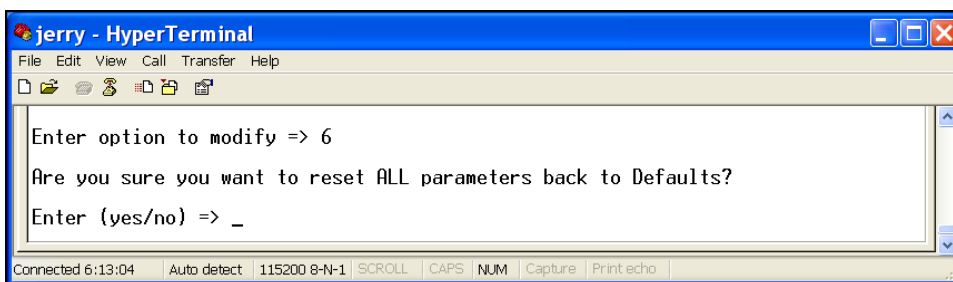

To reset all parameters to back to defaults:

- Enter Yes. Note that you must type the entire word, not just y or n.



## System Reboot

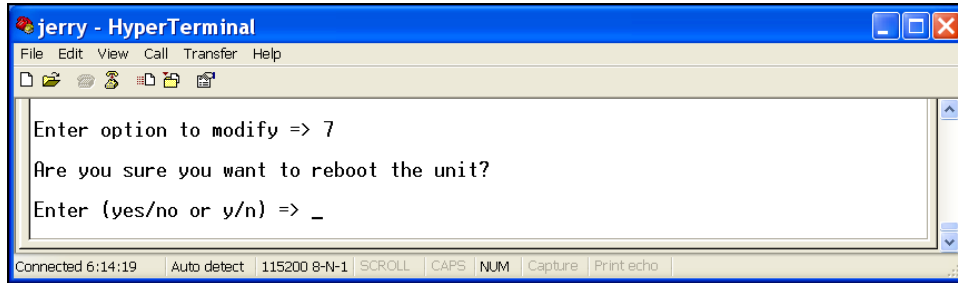

To reboot the system:

- Enter Y or yes.

## Enable Debug

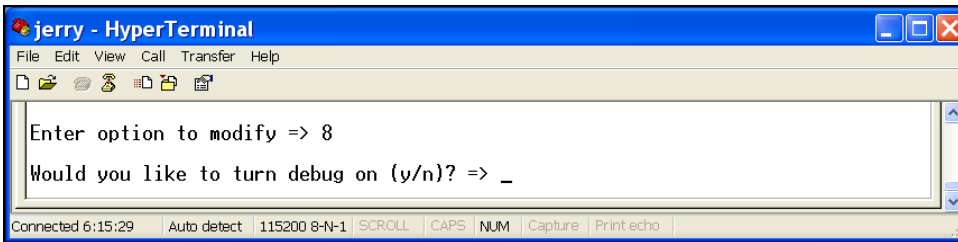

To turn on debugging:

- Enter Y.

# Chapter 5 – Upgrading Firmware

Your device is controlled by semi-permanent firmware, which is stored in flash memory. The firmware stays in memory when the modem is turned off. It can be updated when new features are added.

Since the firmware in your unit is stored in flash memory, you can upgrade the firmware in a few minutes.

## Determining if You Need to Upgrade the Firmware

1. Use a terminal emulation program to login to the device. The firmware version displays in the Introduction Menu. In the image below, the version is 1.0.10, dated Aug 29 2011 10:02:03.

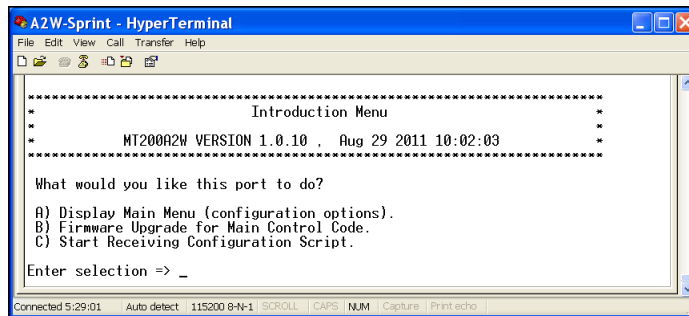

```
A2W-Sprint - HyperTerminal
File Edit View Call Transfer Help
-----
* Introduction Menu *
* MT200A2W VERSION 1.0.10 , Aug 29 2011 10:02:03 *
-----
What would you like this port to do?
A) Display Main Menu (configuration options).
B) Firmware Upgrade for Main Control Code.
C) Start Receiving Configuration Script.
Enter selection => _
```

2. Go to [http://www.multitech.com/en\\_US/SUPPORT/Updates/Firmware](http://www.multitech.com/en_US/SUPPORT/Updates/Firmware).
3. Select MultiConnectAW from the Product Family drop down list or select your specific model from the **Select a Model** drop down list.
4. Look at the firmware version number.
  - If the firmware version number matches the firmware version number in Step 1, your firmware is current.
  - If the firmware version number is greater than the firmware version number found in Step 1, you need to upgrade your unit's firmware.
5. Make a note of your configuration settings. You may need to restore some settings after the upgrade.

## Downloading the Upgrade File and the Flash Wizard

1. Right-click on the firmware file link from [http://www.multitech.com/en\\_US/SUPPORT/Updates/Firmware](http://www.multitech.com/en_US/SUPPORT/Updates/Firmware) and save the file in a temporary folder on your hard disk.
2. Go to <http://www.multitech.com/setup/product.go> and select your model from the **Choose your Product** drop down list.
3. Click Software.
4. Click the **Flash Wizard** link and run the installation program.
5. Find the firmware file and double-click the file name to open the WinZip Self-Extractor.
6. Click **Browse** and find the **Flash Wizard** folder. In a default installation, this is C:\Program Files\MultiTech Systems\Firmware\Flash Wizard\. Click Unzip. You must extract the firmware file to the Flash Wizard folder.

## Identifying the COM port

1. Go to **Start | Control Panel** and then **Open Device Manager**.

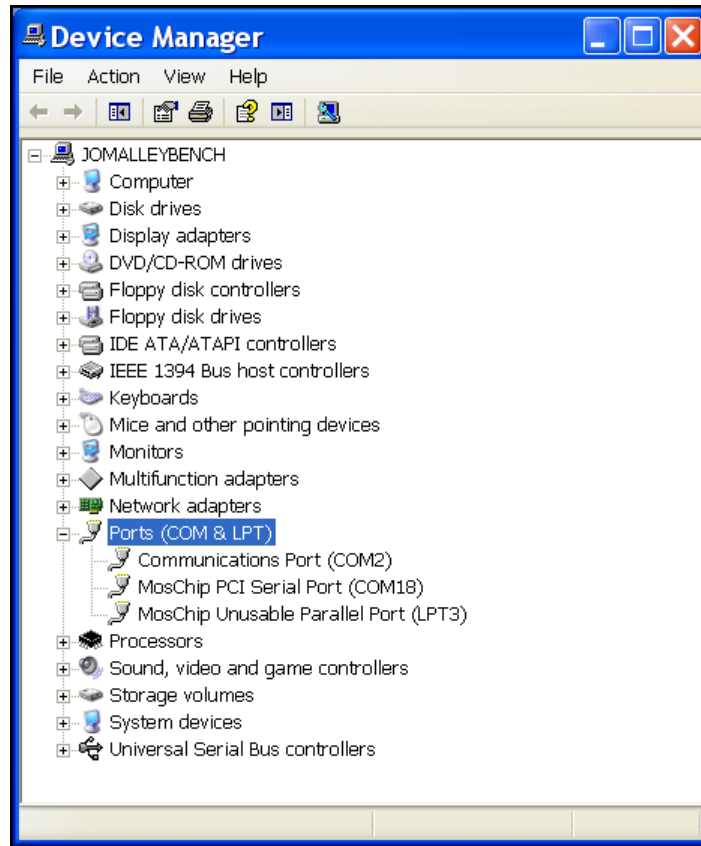

2. Verify the COM port that is connected to the MT200A2W unit. In this example, it is **MosChip PCI Serial Port (COM18)**.
3. Close the device manager.

## Upgrading Firmware

Note the filename for the new firmware (example: KKQG\_1\_0\_13.hex).

**Warning:** Never install an older version of firmware over a newer version. Doing this WILL DESTROY THE FLASH PROM! If the flash PROM is destroyed, the unit must be sent in for repair.

1. If you closed the HyperTerminal, restart it and log back in.
2. Enter **B** to select B) Firmware Upgrade for Main Control Code. You will be prompted to confirm your selection. Enter **Yes**.

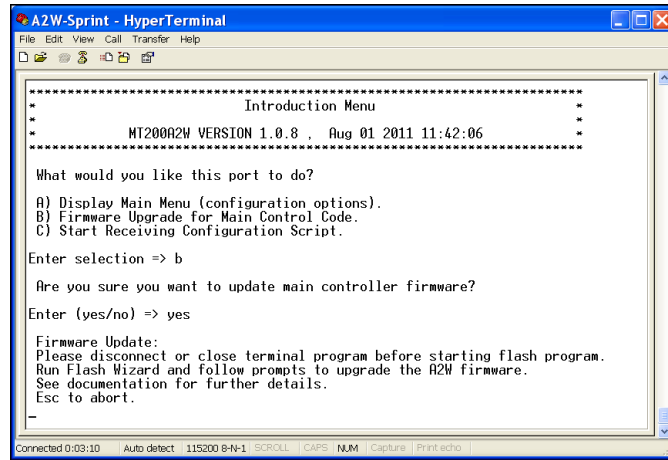

3. Close the terminal program.
4. Double-click the Flash Wizard icon or filename to run Flash Wizard. The Identifying Devices window displays as the Flash Wizard locates and identifies the devices connected to your system.

**Note:** If the message ERROR: No valid devices detected displays, verify that the MultiConnect is turned on, that all cables are correctly and securely attached, and the correct COM port is being used.

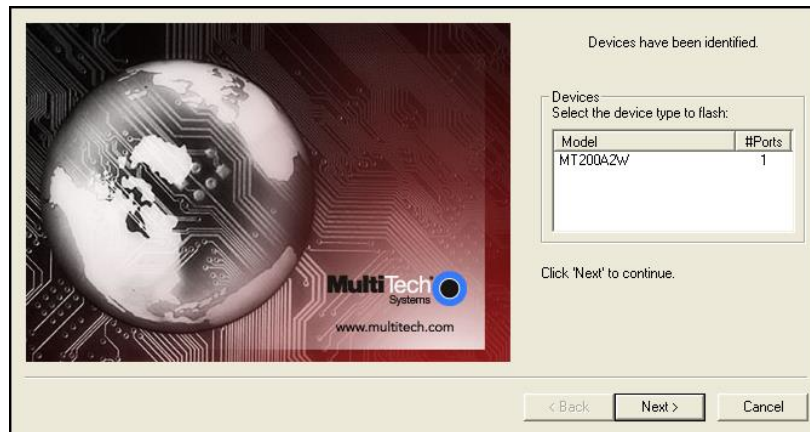

5. Click to highlight the model and click **Next**.
6. Click the port to be upgraded from the **Port** list and click **Next**.

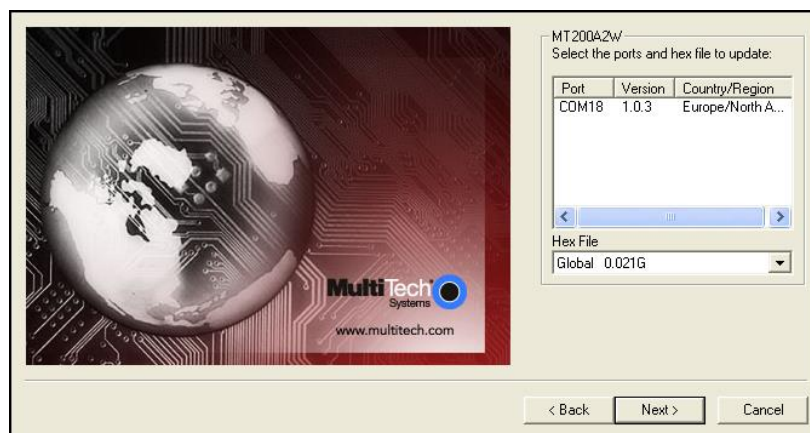

The Progress dialog box appears, showing a status bar that indicates the progress of the upgrade.

**Caution:** Disrupting the Flash Wizard during this stage of the upgrade may make your unit inoperable.

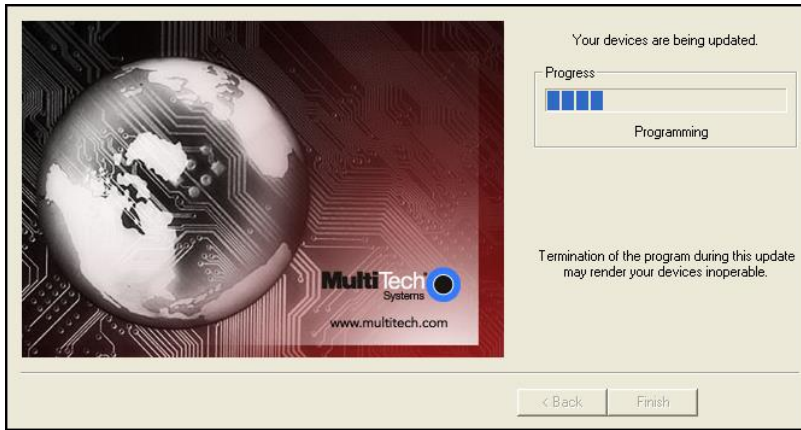

7. When the flash upgrade is complete, **Programming Complete** appears.

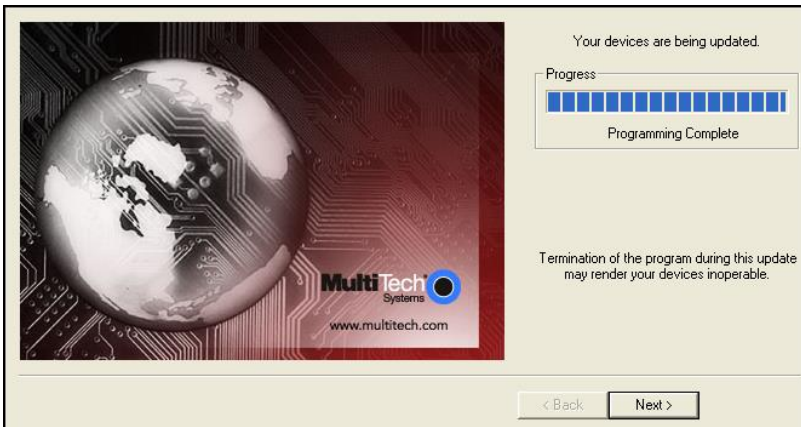

8. Click **Next**. The **Results** window appears.

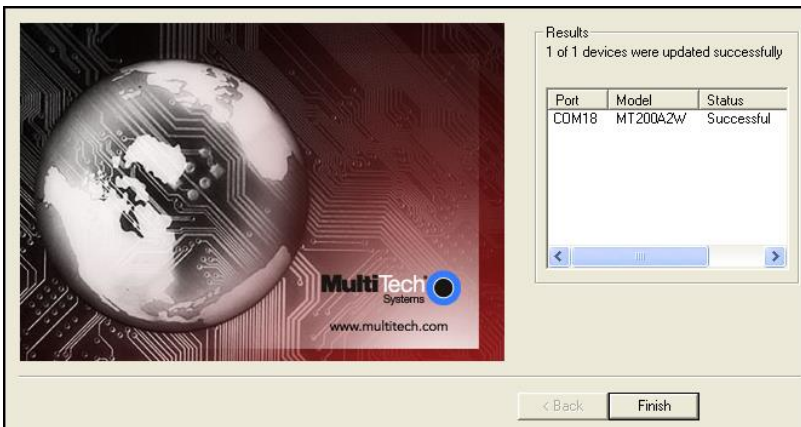

9. Click **Finish** to exit Flash Wizard.

## Restoring Parameters

Your MultiConnect has been updated. You can now open your terminal program to re-set your Device Configuration.

# Chapter 6 – Configuration Scripts

The following are example scripts you can use to configure a MultiConnect through a terminal program. These examples were created with Tera Term. Multi-Tech System does not support the Tera Term terminal emulator; it was used to show how a terminal emulator can be used to configure a script for the MultiConnect.

This chapter includes samples for GPRS/GSM and CDMA configurations.

## GPRS/GSM Configuration Script Example

```
;
;TeraTerm Script
;
;Configuration Script for MT200A2W-G (GPRS) device
;Date: 02/28/2011
;Author:
;Version: 1.0 - Initial Version
;NOTE: use ';' to comment out any option and its corresponding wait'OK'
; that are not needed to be modified.
;
; Parameters within the double quotes are separated by a single space.
; Parameters have to be in Capital letters.
;
; Make sure to reboot the device before running this script

;-----
; Determine which menu we are currently in
;-----
sendln ""
;Send dummy char to get fresh menu
timeout = 3
:LOGIN
wait 'Please enter password to login =>' 'Enter selection =>'
if result=2 then
    pause 1
    goto HANDSHAKE
elseif result=1 then
    timeout = 10
    pause 2
    sendln "admin"          ;Login password
    goto LOGIN
else
    goto LOGIN
endif

:HANDSHAKE
;-----
; Handshake section
;-----

pause 1
sendln "C"
wait 'Are you sure you want to start the configuration script?'
wait 'Enter (yes/no) => '
```

```

sendln "yes"
wait 'ConfigMenuScript'
pause 1

;-----
; Cellular port section
;-----

sendln "1 A GPRS"          ; Choices for the last parameter: "GPRS", "GSM"
wait 'OK'
pause 1

sendln "1 B TCPCLIENT"    ; Choices for the last parameter: "TCPCLIENT", "TELNET", "UDP", "PASSTHRU"
wait 'OK'
pause 1

sendln "1 C OUTBOUND"     ; Choices for the last parameter: "OUTBOUND"
wait 'OK'
pause 1

sendln "1 E 23"           ; Choice for the last parameter: Enter the LOCAL PORT for option E
wait 'OK'
pause 1

sendln "1 F 7000"         ; Choice for the last parameter: Enter the REMOTE PORT for option F
wait 'OK'
pause 1

sendln "1 G 254.254.254.254" ; Choice for the last parameter: Enter the REMOTE IP address for option G
wait 'OK'
pause 1

;***** Phone/IP Conversion Table *****

sendln "1 J 1 7001 7173500 254.254.254.254" ; The last 3 parameters are: portnum phonenum IP
wait 'OK'
pause 1

sendln "1 J 2 7002 7173500 254.254.254.254" ; The last 3 parameters are: portnum phonenum IP
wait 'OK'
pause 1

sendln "1 J 3 7003 7173500 254.254.254.254" ; The last 3 parameters are: portnum phonenum IP
wait 'OK'
pause 1

sendln "1 J 4 7004 7173500 254.254.254.254" ; The last 3 parameters are: portnum phonenum IP
wait 'OK'
pause 1

sendln "1 J 5 7005 7173500 254.254.254.254" ; The last 3 parameters are: portnum phonenum IP
wait 'OK'
pause 1

;*****

sendln "1 K NAM"          ; for the last parameter: "NAM", "EURO"
wait 'OK'

```

```
pause 1
```

```
; sendln "1 L ???" ; for the last parameter: Enter the APN USERNAME for option L if applicable  
; wait 'OK'  
; pause 1
```

```
; sendln "1 M ???" ; for the last parameter: Enter the APN PASSWORD for option M if applicable  
; wait 'OK'  
; pause 1
```

```
sendln "1 N wap.cingular" ; last parameter: Enter the APN SERVER for option N if applicable  
wait 'OK'  
pause 1
```

```
; sendln "1 O 15" ; Choice for the last parameter: Enter the Physical TimeOut in minute for option O  
; wait 'OK'  
; pause 1
```

```
; sendln "1 P ON" ; Choices for the last parameter: "ON", "OFF"  
; wait 'OK'  
; pause 1
```

```
; sendln "1 Q 100" ; last parameter: Enter the TCP package transmit delay in msec for option Q  
; wait 'OK'  
; pause 1
```

```
; sendln "1 R 90" ; last parameter: Enter the radio handshake TimeOut in sec for option R  
; wait 'OK'  
; pause 1
```

```
; sendln "1 S 1234" ; last parameter: "DISABLE", or Enter the SIM unlock code for option S  
; wait 'OK'  
; pause 1
```

```
-----  
; Analog port section - In most cases, this section can be commented out  
-----
```

```
; sendln "2 A ATI" ; last parameter: Enter the init string you want to send to the analog modem  
; wait 'OK'  
; pause 1
```

```
; sendln "2 B A 33600" ; for the last parameter: "56000", "33600", "28800", "14400",  
; "12000", "9600", "4800", "2400", "2200", "1200", "300"  
; wait 'OK'  
; pause 1
```

```
; sendln "2 B B V34" ; for the last parameter: "V92", "V90", "V34", "V32BIS", "V32", "V22BIS",  
; "V22", "BELL212A", "BELL103"  
; wait 'OK'  
; pause 1
```

```
; sendln "2 B C V42_MNP" ; for the last parameter: "V42_MNP", "V42_ONLY", "MNP_DIRECT_MODE", "NO_ECM"  
; wait 'OK'  
; pause 1
```

```
; sendln "2 B D V42BIS_MNP5" ; Choices for the last parameter: "V42BIS_MNP5", "NO_COMPRESSION"  
; wait 'OK'
```



```

; pause 1

; sendln "2 B E RTS_CTS"      ; Choices for the last parameter: "RTS_CTS", "XON_XOFF", "DISABLE"
; wait 'OK'
; pause 1

; sendln "2 B F ON"          ; Choices for the last parameter: "ON", "OFF"
; wait 'OK'
; pause 1

; sendln "2 B G 90"          ; last parameter: Enter the Analog modem handshake timeOut in seconds
; wait 'OK'
; pause 1

;-----
; System Login section
;-----

; sendln "3 ON"              ; Choices for the last parameter: "ON", "OFF"
; wait 'OK'
; pause 1

;-----
; Changing System Login Password - In most cases, this section can be commented out
;-----

; sendln "3 C ????? ??????" ; Choices for the last 2 parameters: old password, new password
; wait 'OK'
; pause 1

;-----
; Timers section - In most cases, this section can be commented out
;-----

; sendln "4 A 0"             ; Choice for the last parameter: Enter the Menu Inactivity timer in seconds
; wait 'OK'
; pause 1

; sendln "4 B 300"           ; Choice for the last parameter: Enter the No Signal Reset timer in seconds
; wait 'OK'
; pause 1

; sendln "4 C 5"             ; last parameter: Enter the Timeout Between Dialed Digits in seconds
; wait 'OK'
; pause 1

;-----
; Debug section - Enable or Disable debug
;-----

; sendln "8 Y"               ; Choices for the last parameter: "Y", "N"
; wait 'OK'
; pause 1

;-----
; Wireless Connection - save this option for last because if "Always On" is selected because the
; system will start the connection right away!

```

```
;-----  
sendln "1 D ON_DEMAND"      ; Choices for the last parameter: "ON_DEMAND", "ALWAYS_ON"  
wait 'OK'  
pause 1
```

```
;-----  
; Save Configuration?  
;-----
```

```
sendln "SAVE"  
wait 'OK'  
pause 3
```

```
;-----  
; Configuration is done  
;-----
```

```
sendln "FINISH"
```

## CDMA Configuration Script Example

```
;  
TaraTerm Script  
;  
;Configuration Script for MT100A2W (CDMA) device  
;Date: 07/14/2009  
;Author:  
;Version: 1.0 - Initial Version  
;  
; 12/09/2009 - Added "Debug section - Enable or Disable debug"  
  
;NOTE: use ';' to comment out any option and its corresponding wait'OK'  
; that are not needed to be modified.  
;  
; Parameters within the double quotes are seperated by a single space.  
; Parameters have to be in Capital letters.  
;  
; Make sure to reboot the device before running this script
```

```
;-----  
; Determind which menu we are currently in  
;-----
```

```
send 13  
timeout = 10  
wait 'Please enter password to login =>' 'Enter selection =>'  
if result=1 goto LOGIN  
sendln "!"  
pause 2  
:LOGIN  
timeout = 0  
pause 2  
sendln "admin"
```

```
:HANDSHAKE
```

```
;-----  
; Handshake section  
;-----
```

```

pause 1
sendln "C"
wait 'Are you sure you want to start the configuration script?'
wait 'Enter (yes/no) => '
sendln "yes"
wait 'ConfigMenuScript'
pause 1

;-----
; Cellular port section
;-----

sendln "1 B TCPCLIENT"      ; Choices for the last parameter: "TCPCLIENT", "TELNET", "UDP", "PASSTHRU"
wait 'OK'

sendln "1 C OUTBOUND"      ; Choices for the last parameter: "AUTODETECT", "OUTBOUND", "INBOUND"
wait 'OK'

sendln "1 E 23"            ; Choice for the last parameter: Enter the LOCAL PORT for option E
wait 'OK'

sendln "1 F 7000"          ; Choice for the last parameter: Enter the REMOTE PORT for option F
wait 'OK'

sendln "1 G 65.126.90.5"   ; Choice for the last parameter: Enter the REMOTE IP address for option G
wait 'OK'

;***** Phone/IP Conversion Table *****

sendln "1 J 1 7001 7173500 254.254.254.254" ; The last 3 parameters are: portnum phonenum IP
wait 'OK'

sendln "1 J 2 7002 7173500 254.254.254.254" ; The last 3 parameters are: portnum phonenum IP
wait 'OK'

sendln "1 J 3 7003 7173500 254.254.254.254" ; The last 3 parameters are: portnum phonenum IP
wait 'OK'

sendln "1 J 4 7004 7173500 254.254.254.254" ; The last 3 parameters are: portnum phonenum IP
wait 'OK'

sendln "1 J 5 7005 7173500 254.254.254.254" ; The last 3 parameters are: portnum phonenum IP
wait 'OK'

;*****

; sendln "1 R 90"      ; last parameter: Enter the radio handshake TimeOut in sec for option R
; wait 'OK'

;-----
; Analog port section - In most cases, this section can be commented out
;-----

; sendln "2 A ATI"    ; last parameter: Enter the init string you want to send to the analog modem
; wait 'OK'

; sendln "2 B A 33600" ; Choices for the last parameter: "56000", "33600", "28800", "14400",

```

```
; wait 'OK'          ; "12000", "9600", "4800", "2400", "2200", "1200", "300"

; sendln "2 B B V34"  ; Choices for the last parameter: "V92", "V90", "V34", "V32BIS", "V32",
; wait 'OK'          ; "V22BIS", "V22", "BELL212A", "BELL103"

; sendln "2 B C V42_MNP" ; last parameter: "V42_MNP", "V42_ONLY", "MNP DIRECT_MODE", "NO_ECM"
; wait 'OK'

; sendln "2 B D V42BIS_MNP5" ; Choices for the last parameter: "V42BIS_MNP5", "NO_COMPRESSION"
; wait 'OK'

; sendln "2 B E RTS_CTS" ; Choices for the last parameter: "RTS_CTS", "XON_XOFF", "DISABLE"
; wait 'OK'

; sendln "2 B F ON"    ; Choices for the last parameter: "ON", "OFF"
; wait 'OK'

; sendln "2 B G 90"    ; last parameter: Enter the Analog modem handshake timeOut in seconds
; wait 'OK'

;-----
; System Login section
;-----

sendln "3 OFF"        ; Choices for the last parameter: "ON", "OFF"
wait 'OK'

;-----
; Changing System Login Password - In most cases, this section can be commented out
;-----

; sendln "3 C ?????? ??????" ; Choices for the last 2 parameters: old password, new password
; wait 'OK'

;-----
; Timers section - In most cases, this section can be commented out
;-----

; sendln "4 A 30"    ; Choice for the last parameter: Enter the Menu Inactivity timer in seconds
; wait 'OK'

; sendln "4 C 5"    ; Choice for the last parameter: Enter the Timeout Between Dialed Digits in seconds
; wait 'OK'

;-----
; Email section - In most cases, this section can be commented out
;-----

; sendln "5 A ??????" ; Choice for the last parameter: Enter the SMTP username
; wait 'OK'

; sendln "5 B ??????" ; Choice for the last parameter: Enter the SMTP password
; wait 'OK'

; sendln "5 C 25"    ; Choice for the last parameter: Enter the SMTP portnum
; wait 'OK'

; sendln "5 D ON"    ; Choices for the last parameter: "ON", "OFF"
```

```
; wait 'OK'

; sendln "5 E ??????" ; Choice for the last parameter: Enter the SMTP server
; wait 'OK'

; sendln "5 F ??????" ; Choice for the last parameter: Enter the SMTP domain
; wait 'OK'

; sendln "5 G ??????" ; Choice for the last parameter: Enter the SMTP sender's name
; wait 'OK'

; sendln "5 H ??????" ; Choice for the last parameter: Enter the SMTP sender's address
; wait 'OK'

; sendln "5 I ??????" ; Choice for the last parameter: Enter the SMTP recipient's address
; wait 'OK'

;-----
; Debug section - Enable or Disable debug
;-----
sendln "8 Y" ; Choices for the last parameter: "Y", "N"
wait 'OK'

;-----
; Wireless Connection - save this option for last because if "Always On" is selected, the system
; will start the connection right away!
;-----
sendln "1 D ON_DEMAND" ; Choices for the last parameter: "ON_DEMAND", "ALWAYS_ON"
wait 'OK'

;-----
; Save Configuration?
;-----

; sendln "SAVE"
; wait 'OK'

;-----
; Configuration is done
;-----
sendln "FINISH"
```

# Chapter 7 – Troubleshooting

## Flashing Signal Strength LEDs

Flashing signal strength LEDs indicate a failure condition has occurred.

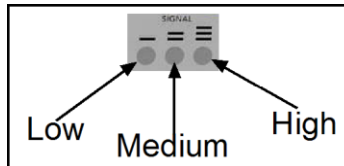

- **Low Flashing LED** – Physical connection failed
- **Medium Flashing LED** – Analog line has returned to on-hook
- **High Flashing LED** – PPP user interrupt error
- **Low and Medium Flashing LEDs** – PPP failed to meet protocol error
- **Low and High Flashing LEDs** – PPP connection lost
- **Medium and High Flashing LEDs** – PPP failed authentication challenge
- **Low, Medium, High Flashing at 50 msec** – Get host by name failed
- **Low, Medium, High Flashing at 200 msec** – Failed to create TCP socket
- **Low, Medium, High Flashing at 800 msec** – Network connection failed

# Appendix A – Regulatory Compliance



## EMC, Safety, and Radio Equipment Directive (RED) Compliance

The CE mark is affixed to this product to confirm compliance with the following European Community Directives:

Council Directive 2011/65/EU on the restriction of the use of certain hazardous substances in electrical and electronic equipment;

and

Council Directive 2014/53/EU on radio equipment and telecommunications terminal equipment and the mutual recognition of their conformity.

Multitech declares that this device is in compliance with the essential requirements and other relevant provisions of Directive 2014/53/EU. The declaration of conformity may be requested at <https://support.multitech.com>.

## International Modem Restrictions

Some dialing and answering defaults and restrictions may vary for international modems. Changing settings may cause a modem to become non-compliant with national telecom requirements in specific countries. Also note that some software packages may have features or lack restrictions that may cause the modem to become non-compliant.

## 47 CFR Part 15 Regulation Class B Devices

This equipment has been tested and found to comply with the limits for a Class B digital device, pursuant to part 15 of the FCC Rules. These limits are designed to provide reasonable protection against harmful interference in a residential installation. This equipment generates, uses, and can radiate radio frequency energy and, if not installed and used in accordance with the instructions, may cause harmful interference to radio communications. However, there is no guarantee that interference will not occur in a particular installation. If this equipment does cause harmful interference to radio or television reception, which can be determined by turning the equipment off and on, the user is encouraged to try to correct the interference by one or more of the following measures:

- Reorient or relocate the receiving antenna.
- Increase the separation between the equipment and receiver.
- Connect the equipment into an outlet on a circuit different from that to which the receiver is connected.
- Consult the dealer or an experienced radio/TV technician for help.

**Warning:** Changes or modifications to this unit not expressly approved by the party responsible for compliance could void the user's authority to operate the equipment.

## Industry Canada

This Class B digital apparatus meets all requirements of the Canadian Interference-Causing Equipment Regulations.

Cet appareil numérique de la classe B respecte toutes les exigences du Règlement Canadien sur le matériel brouilleur.

This device complies with Industry Canada RSS Appliance radio exempt from licensing. The operation is permitted for the following two conditions:

1. the device may not cause harmful interference, and
2. the user of the device must accept any interference suffered, even if the interference is likely to jeopardize the operation.

Le présent appareil est conforme aux CNR d'Industrie Canada applicables aux appareils radio exempts de licence. L'exploitation est autorisée aux deux conditions suivantes:

1. l'appareil ne doit pas produire de brouillage, et
2. l'utilisateur de l'appareil doit accepter tout brouillage radioélectrique subi, même si le brouillage est susceptible d'en compromettre le fonctionnement.

## Waste Electrical and Electronic Equipment Statement

### WEEE Directive

The WEEE Directive places an obligation on EU-based manufacturers, distributors, retailers, and importers to take-back electronics products at the end of their useful life. A sister directive, ROHS (Restriction of Hazardous Substances) complements the WEEE Directive by banning the presence of specific hazardous substances in the products at the design phase. The WEEE Directive covers all Multi-Tech products imported into the EU as of August 13, 2005. EU-based manufacturers, distributors, retailers and importers are obliged to finance the costs of recovery from municipal collection points, reuse, and recycling of specified percentages per the WEEE requirements.

### Instructions for Disposal of WEEE by Users in the European Union

The symbol shown below is on the product or on its packaging, which indicates that this product must not be disposed of with other waste. Instead, it is the user's responsibility to dispose of their waste equipment by handing it over to a designated collection point for the recycling of waste electrical and electronic equipment. The separate collection and recycling of your waste equipment at the time of disposal will help to conserve natural resources and ensure that it is recycled in a manner that protects human health and the environment. For more information about where you can drop off your waste equipment for recycling, please contact your local city office, your household waste disposal service or where you purchased the product.

July, 2005





# REACH Statement

## Registration of Substances

After careful review of the legislation and specifically the definition of an “article” as defined in EC Regulation 1907/2006, Title II, Chapter 1, Article 7.1(a)(b), it is our current view Multi-Tech Systems, Inc. products would be considered as “articles”. In light of the definition in § 7.1(b) which requires registration of an article only if it contains a regulated substance that “is intended to be released under normal or reasonably foreseeable conditions of use,” Our analysis is that Multi-Tech Systems, Inc. products constitute nonregisterable articles for their intended and anticipated use.

## Substances of Very High Concern (SVHC)

Per the candidate list of Substances of Very High Concern (SVHC) published October 28, 2008 we have reviewed these substances and certify the Multi-Tech Systems, Inc. products are compliant per the EU “REACH” requirements of less than 0.1% (w/w) for each substance. If new SVHC candidates are published by the European Chemicals Agency, and relevant substances have been confirmed, that exceeds greater than 0.1% (w/w), Multi-Tech Systems, Inc. will provide updated compliance status.

Multi-Tech Systems, Inc. also declares it has been duly diligent in ensuring that the products supplied are compliant through a formalized process which includes collection and validation of materials declarations and selective materials analysis where appropriate. This data is controlled as part of a formal quality system and will be made available upon request.

## Restriction of the Use of Hazardous Substances (RoHS)



**Multi-Tech Systems, Inc.**  
**Certificate of Compliance**  
**2011/65/EU**

Multi-Tech Systems confirms that its embedded products comply with the chemical concentration limitations set forth in the directive 2011/65/EU of the European Parliament (Restriction of the use of certain Hazardous Substances in electrical and electronic equipment - RoHS)

These Multi-Tech products do not contain the following banned chemicals<sup>1</sup>:

- Lead, [Pb] < 1000 PPM
- Mercury, [Hg] < 1000 PPM
- Hexavalent Chromium, [Cr+6] < 1000 PPM
- Cadmium, [Cd] < 100 PPM
- Polybrominated Biphenyl, [PBB] < 1000 PPM
- Polybrominated Diphenyl Ether, [PBDE] < 1000 PPM

Environmental considerations:

- Moisture Sensitivity Level (MSL) =1
- Maximum Soldering temperature = 260C (in SMT reflow oven)

<sup>1</sup>Lead usage in some components is exempted by the following RoHS annex, therefore higher lead concentration would be found in some modules (>1000 PPM);

–Resistors containing lead in a glass or ceramic matrix compound.

## Information on HS/TS Substances According to Chinese Standards

In accordance with China's Administrative Measures on the Control of Pollution Caused by Electronic Information Products (EIP) # 39, also known as China RoHS, the following information is provided regarding the names and concentration levels of Toxic Substances (TS) or Hazardous Substances (HS) which may be contained in Multi-Tech Systems Inc. products relative to the EIP standards set by China's Ministry of Information Industry (MII).

Name of the Component	Hazardous/Toxic Substance/Elements					
	Lead (PB)	Mercury (Hg)	Cadmium (CD)	Hexavalent Chromium (CR6+)	Polybrominated Biphenyl (PBB)	Polybrominated Diphenyl Ether (PBDE)
Printed Circuit Boards	O	O	O	O	O	O
Resistors	X	O	O	O	O	O
Capacitors	X	O	O	O	O	O
Ferrite Beads	O	O	O	O	O	O
Relays/Opticals	O	O	O	O	O	O
ICs	O	O	O	O	O	O
Diodes/ Transistors	O	O	O	O	O	O
Oscillators and Crystals	X	O	O	O	O	O
Regulator	O	O	O	O	O	O
Voltage Sensor	O	O	O	O	O	O
Transformer	O	O	O	O	O	O
Speaker	O	O	O	O	O	O
Connectors	O	O	O	O	O	O
LEDs	O	O	O	O	O	O
Screws, Nuts, and other Hardware	X	O	O	O	O	O
AC-DC Power Supplies	O	O	O	O	O	O
Software / Documentation CDs	O	O	O	O	O	O
Booklets and Paperwork	O	O	O	O	O	O
Chassis	O	O	O	O	O	O

- X** Represents that the concentration of such hazardous/toxic substance in all the units of homogeneous material of such component is higher than the SJ/Txxx-2006 Requirements for Concentration Limits.
- O** Represents that no such substances are used or that the concentration is within the aforementioned limits.

## Information on HS/TS Substances According to Chinese Standards (in Chinese)

### 依照中国标准的有毒有害物质信息

根据中华人民共和国信息产业部 (MII) 制定的电子信息产品 (EIP) 标准—中华人民共和国《电子信息产品污染控制管理办法》(第 39 号), 也称作中国 RoHS, 下表列出了 Multi-Tech Systems, Inc. 产品中可能含有的有毒物质 (TS) 或有害物质 (HS) 的名称及含量水平方面的信息。

成分名称	有害/有毒物质/元素					
	铅 (PB)	汞 (Hg)	镉 (CD)	六价铬 (CR6+)	多溴联苯 (PBB)	多溴二苯醚 (PBDE)
印刷电路板	0	0	0	0	0	0
电阻器	X	0	0	0	0	0
电容器	X	0	0	0	0	0
铁氧体磁环	0	0	0	0	0	0
继电器/光学部件	0	0	0	0	0	0
IC	0	0	0	0	0	0
二极管/晶体管	0	0	0	0	0	0
振荡器和晶振	X	0	0	0	0	0
调节器	0	0	0	0	0	0
电压传感器	0	0	0	0	0	0
变压器	0	0	0	0	0	0
扬声器	0	0	0	0	0	0
连接器	0	0	0	0	0	0
LED	0	0	0	0	0	0
螺丝、螺母以及其它五金件	X	0	0	0	0	0
交流-直流电源	0	0	0	0	0	0
软件/文档 CD	0	0	0	0	0	0
手册和纸页	0	0	0	0	0	0
底盘	0	0	0	0	0	0

- X 表示所有使用类似材料的设备中有害/有毒物质的含量水平高于 SJ/Txxx-2006 限量要求。  
 0 表示不含该物质或者该物质的含量水平在上述限量要求之内。