

300mA Variable Output LDO Regulator



BA3662CP-V5

●General Description

The BA3662CP-V5 is low-saturation regulator. The output voltage can be arbitrarily configured using the external resistance. This IC has a built-in over-current protection circuit that prevents the destruction of the IC due to output short circuits and a thermal shutdown circuit that protects the IC from thermal damage due to overloading.

●Features

- High Output Voltage Precision : $\pm 2\%$
- Low saturation with PNP output
- Built-in over-current protection circuit that prevents the destruction of the IC due to output short circuits
- Built-in thermal shutdown circuit for protecting the IC from thermal damage due to overloading
- Built-in over-voltage protection circuit that prevents the destruction of the IC due to power supply surges

●Key Specifications

- Input Power Supply Voltage: 25V(Max.)
- Output voltage type: Fixed
- Output current: 0.3A(Max.)
- Shutdown current: 0 μ A(Typ.)
- Operating temperature range: -40°C to +125°C

●Applications

Audiovisual equipments, FPDs, televisions, personal computers or any other consumer device

●Typical Application Circuit

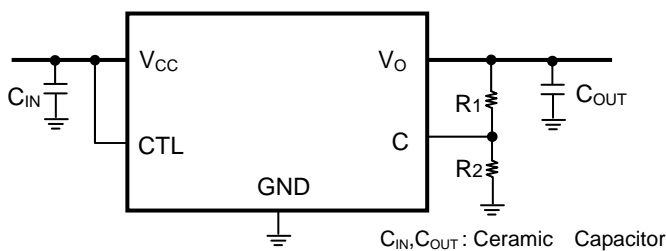

●Package

TO220CP-V5

W (Typ.) x D (Typ.) x H (Max.)
10.00mm x 20.12mm x 4.60mm



●Ordering Information

BA3662CP-V5 - E2

Part Number

Package
CP-V5: TO220CP-V5

Packaging and forming specification
E2: Embossed tape and reel

●Lineup

Maximum output current (Max.)	Output Voltage (Max.)	Package		Orderable Part Number
0.3A	15V	TO220CP-V5	Reel of 500	BA3662CP-V5E2

○Product structure : Silicon monolithic integrated circuit ○This product is not designed protection against radioactive rays.

●Block Diagram

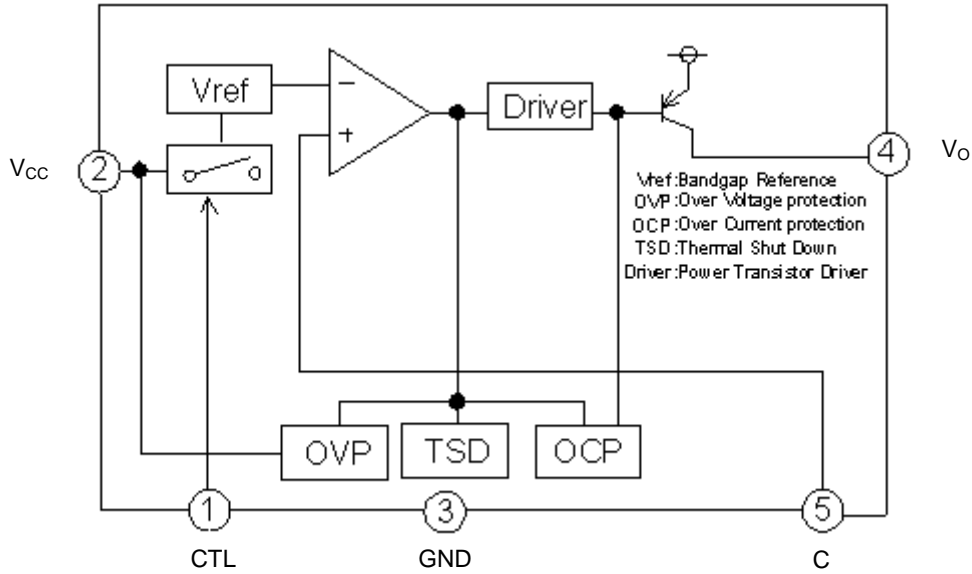
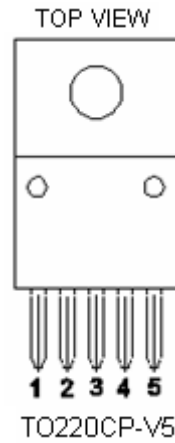

Fig.1

●Pin Configuration



●Pin Description

Pin No.	Pin Name	Function
1	CTL	Output Control Pin
2	Vcc	Power Supply Pin
3	GND	GND
4	Vo	Output Pin
5	C	Adjustable Pin

● Absolute Maximum Ratings (Ta=25°C)

Parameter	Symbol	Ratings	Unit
Supply Voltage ※1	V _{CC}	-0.3 to +35.0	V
Output Control Voltage	V _{CTL}	-0.3 to +V _{CC}	V
Power Dissipation ※2	P _d	2000	mW
Operating Temperature Range	Topr	-40 to +125	°C
Storage Temperature Range	Tstg	-55 to +150	°C
Maximum Junction Temperature	Tjmax	+150	°C
Peak Supply Voltage ※3	V _{CC peak}	+50	V

※ 1 Not to exceed P_d.

※ 2 TO220CP-V5:Derating in done at 16mW/°C for operating above Ta≥25°C.(without heat sink)

※ 3 Applied voltage : 200msec or less (tr≥1msec)

NOTE : This product is not designed for protection against radioactive rays.

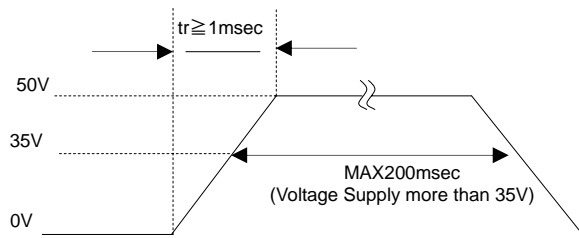

● Recommended Operating Ratings (Ta=-40 to +125°C)

Parameter	Symbol	Min.	Max.	Unit
Supply Voltage	V _{CC}	4.0	25.0	V
Output Control Voltage	V _{CTL}	0	V _{CC}	V
Output Current	I _o	0	0.3	A
Output Voltage	V _o	3.0	15.0	V

● Protect Features

Parameter	Symbol	Min.	Typ.	Max.	Unit
Over Voltage protection	V _{CC}	26	28	30	V

● Electrical Characteristics(Unless otherwise specified, Ta=25°C, V_{CC}=10V, V_{CTL}=5V, I_o=200mA, R₁=2.2kΩ, R₂=6.8kΩ)

Parameter	Symbol	Min.	Typ.	Max.	Unit	Conditions
Shut Down Current	I _{sd}	—	0	10	μA	V _{CTL} =0V
Bias Current	I _b	—	2.5	5.0	mA	V _{CTL} =2V, I _o =0mA
C Terminal Voltage	V _c	1.200	1.225	1.250	V	I _o =50mA
Dropout Voltage	ΔV _d	—	0.3	0.5	V	V _{CC} =V _o × 0.95
Ripple Rejection	R.R.	45	55	—	dB	f=120Hz, e _{in} *1=1Vrms, I _o =100mA
Line Regulation	Reg.I	—	20	100	mV	V _{CC} =6→25V
Load Regulation	Reg.L	—	40	80	mV	I _o =5mA→200mA
Temperature Coefficient of Output Voltage	T _{co}	—	±0.02	—	%/°C	I _o =5mA, T _j =0°C to 125°C
Short Current	I _{os}	—	0.1	—	A	V _{CC} =25V, V _o =0V
ON Mode Voltage	V _{thH}	2.0	—	—	V	ACTIVE MODE, I _o =0mA
OFF Mode Voltage	V _{thL}	—	—	0.8	V	OFF MODE, I _o =0mA
Input High Current	I _{CTL}	100	200	300	μA	V _{CTL} =5V, I _o =0mA

※ 1 e_{in} : Input Voltage Ripple

● Typical Performance Curves

BA3662CP-V5(5.0V preset voltage)

(Unless otherwise specified, $T_a=25^{\circ}\text{C}$, $V_{CC}=10\text{V}$, $V_{CTL}=5\text{V}$, $I_o=200\text{mA}$, $R_1=2.2\text{k}\Omega$, $R_2=6.8\text{k}\Omega$)

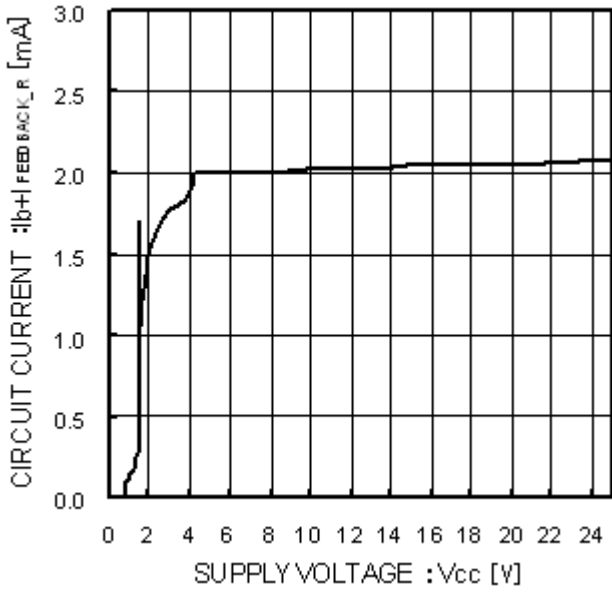

Fig.2
Circuit Current

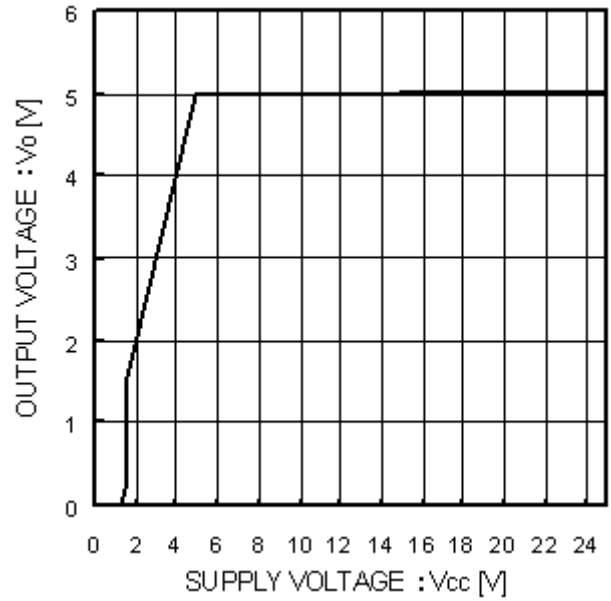

Fig.3
Line Regulation

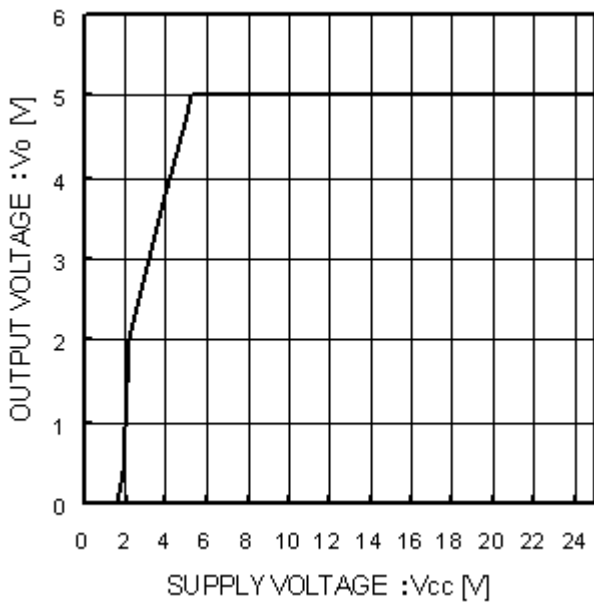

Fig.4
Line Regulation
($I_o=200\text{mA}$)

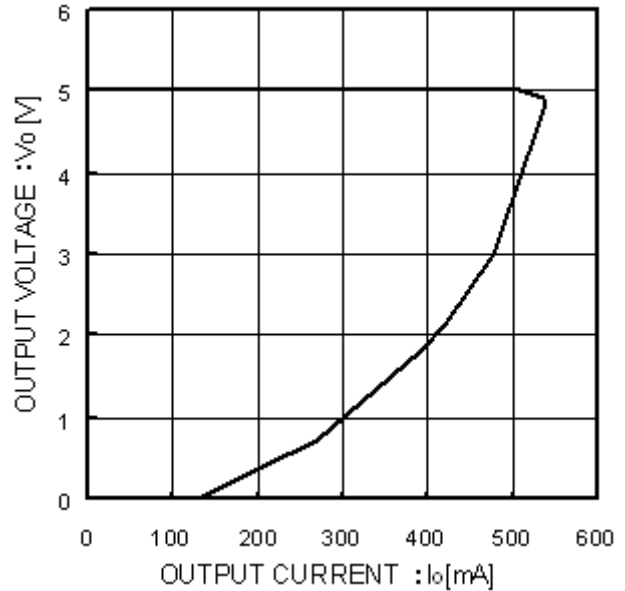

Fig.5
Load Regulation

● Typical Performance Curves - continued

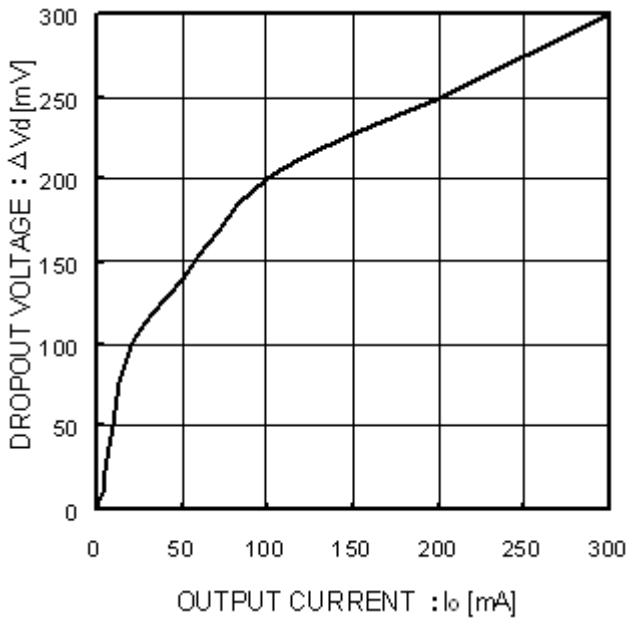

Fig.6
Dropout Voltage I_o-ΔV_d Characteristics
(V_{CC}=4.75V)

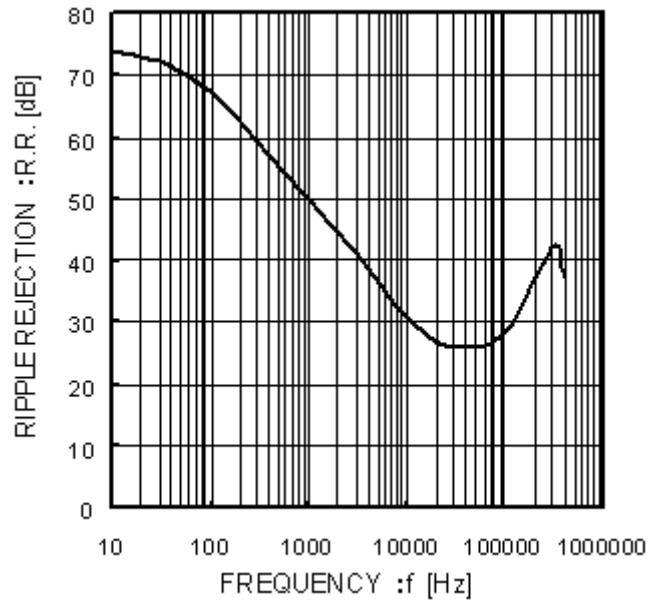

Fig.7
Ripple Rejection
(I_o=100mA)

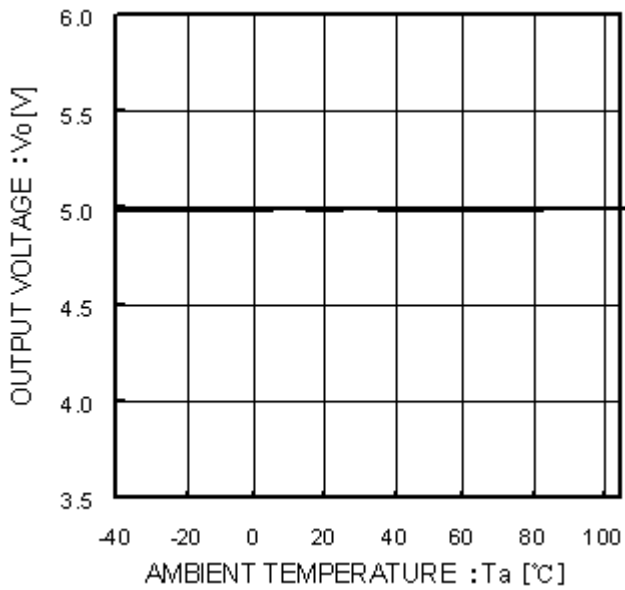

Fig.8
Output Voltage

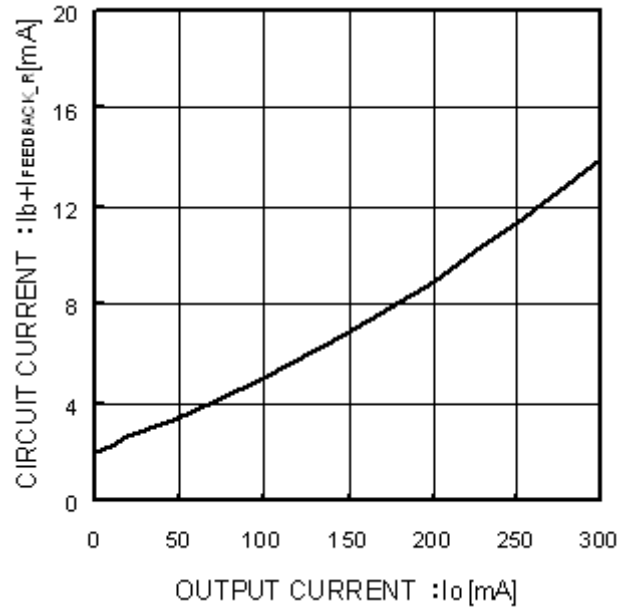

Fig.9
Circuit Current (I_o=0mA→300mA)
(I_{FEEDBACK_R}≒555μA)

● Typical Performance Curves - continued

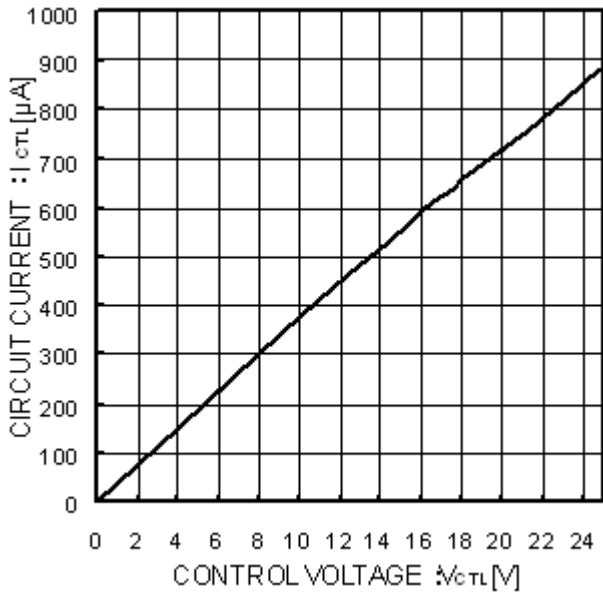

Fig.10
CTL Voltage vs CTL Current

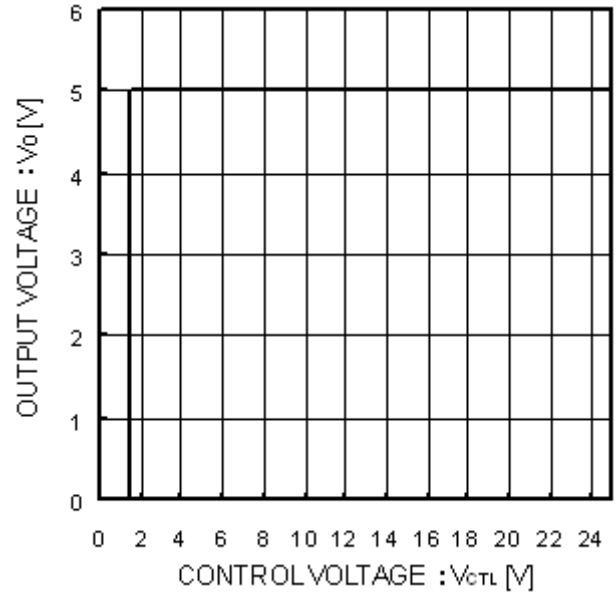

Fig.11
CTL Voltage vs Output Voltage

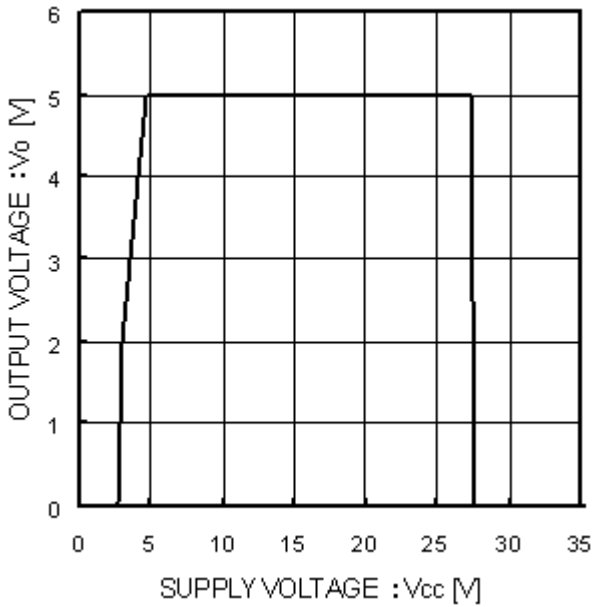

Fig.12
Overshoot Operating
(I_O = 200mA)

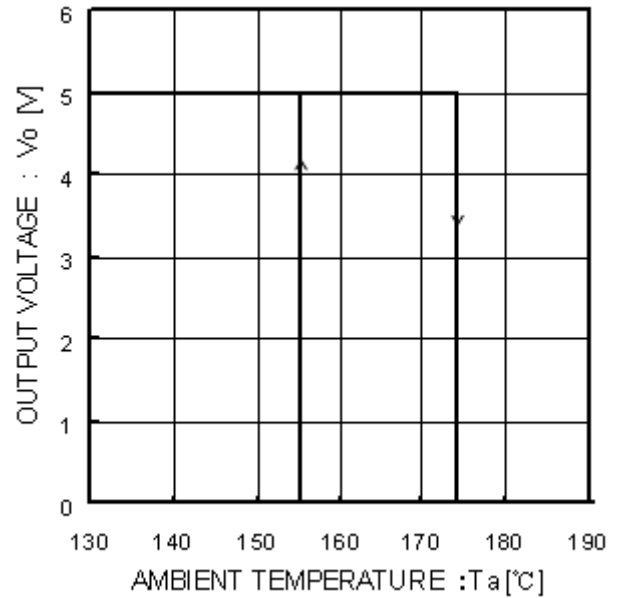
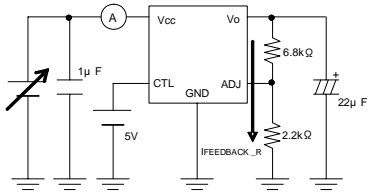
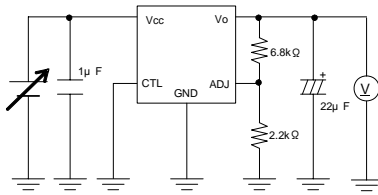

Fig.13
Thermal Shutdown
Circuit Characteristics

● Measurement Circuit for Typical Performance Curves



Measurement Circuit of Fig.2



Measurement Circuit of Fig.3

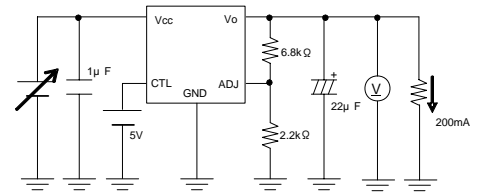

Measurement Circuit of Fig.4

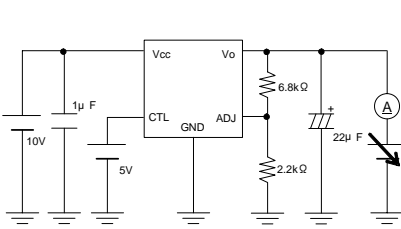

Measurement Circuit of Fig.5

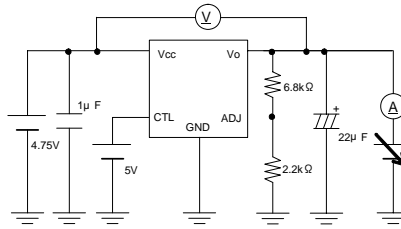

Measurement Circuit of Fig.6

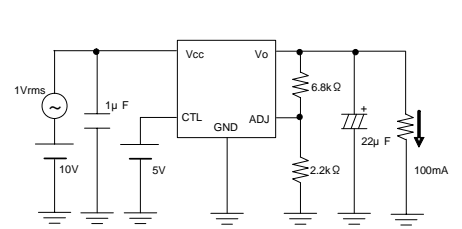

Measurement Circuit of Fig.7

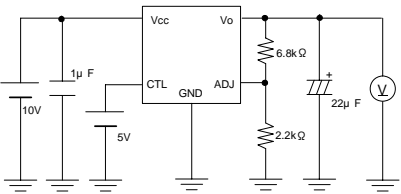

Measurement Circuit of Fig.8

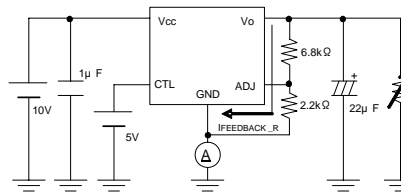

Measurement Circuit of Fig.9

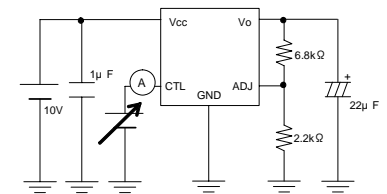

Measurement Circuit of Fig.10

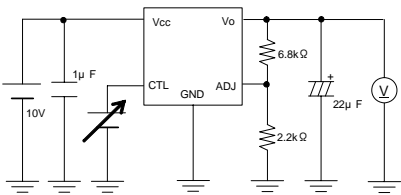

Measurement Circuit of Fig.11

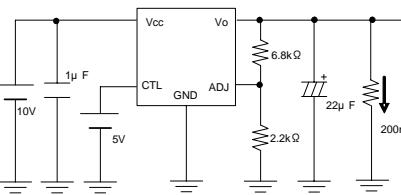

Measurement Circuit of Fig.12

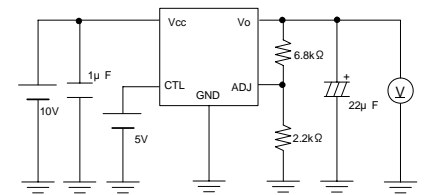

Measurement Circuit of Fig.13

● I/O equivalence circuit

Vcc Pin

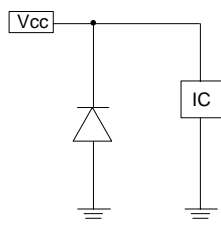

CTL Pin

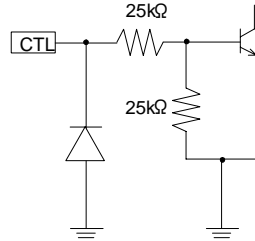

Vo Pin

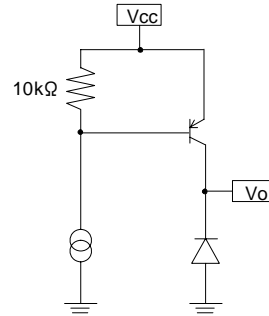

C Pin

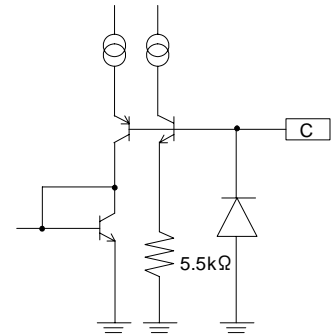

● Output Voltage Configuration Method

Please connect resistors R1 and R2 (which determines the output voltage) as shown in Fig.14.
Please be aware that the offset due to the current that flows from the C pin becomes large when resistors with large values are used. The use of resistors with R1=2kΩ to 15kΩ is recommended.

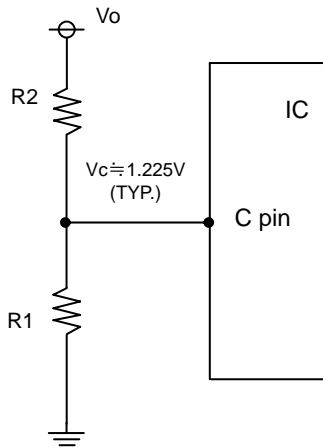

Fig.14

$$V_o \doteq V_c \times (R_1 + R_2) / R_1$$

●Power Dissipation

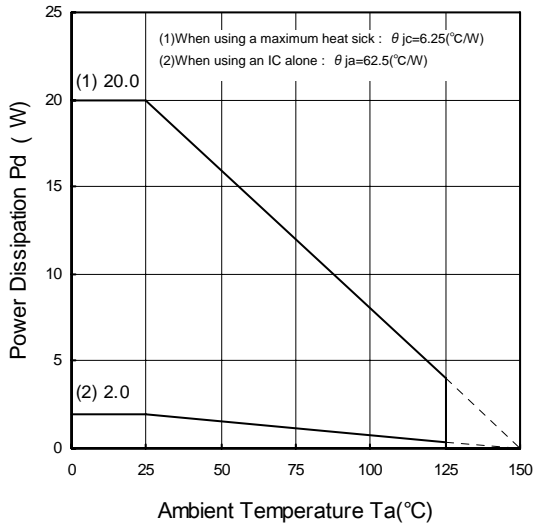

Fig.15

When using at temperatures over Ta=25°C, please refer to the heat reducing characteristics shown in Fig.15. The IC characteristics are closely related to the temperature at which the IC is used, so it is necessary to operate the IC at temperatures less than the maximum junction temperature Tjmax.

Fig.15 shows the acceptable loss and heat reducing characteristics of the TO220CP-V5 package. Even when the ambient temperature Ta is a normal temperature (25°C), the chip (junction) temperature Tj may be quite high so please operate the IC at temperatures less than the acceptable loss Pd.

The calculation method for power consumption Pc(W) is as follows.

$$Pc = (V_{cc} - V_o) \times I_o + V_{cc} \times I_b$$

$$\text{Acceptable loss } Pd \geq Pc$$

Solving this for load current Io in order to operate within the acceptable loss,

$$I_o \leq \frac{Pd - V_{cc} \times I_b}{V_{cc} - V_o}$$

- Vcc: Input voltage
- Vo: Output voltage
- Io: Load current
- Ib: Circuit current
- Ishort: Short current

(Please refer to Fig.9 for Ib.)

It is then possible to find the maximum load current Iomax with respect to the applied voltage Vcc at the time of thermal design.

Calculation Example)

When Ta=85°C, Vcc=10V, Vo=5V

$$I_o \leq \frac{1.04 - 10 \times I_b}{5}$$

$$I_o \leq 192\text{mA} \text{ (Ib:8mA)}$$

$$\left[\begin{array}{l} \text{With the IC alone : } \theta_{ja} = 62.5^\circ\text{C/W} \rightarrow -16\text{mW}/^\circ\text{C} \\ 25^\circ\text{C} = 2.0\text{W} \rightarrow 85^\circ\text{C} = 1.04\text{W} \end{array} \right]$$

Please refer to the above information and keep thermal designs within the scope of acceptable loss for all operating temperature ranges. The power consumption Pc of the IC when there is a short circuit (short between Vo and GND) is :

$$Pc = V_{cc} \times (I_b + I_{short}) \quad (\text{Please refer to Fig.5 for } I_{short}.)$$

●Operational Notes

1. Absolute maximum ratings
Use of the IC in excess of absolute maximum ratings (such as the input voltage or operating temperature range) may result in damage to the IC. Assumptions should not be made regarding the state of the IC (e.g., short mode or open mode) when such damage is suffered. If operational values are expected to exceed the maximum ratings for the device, consider adding protective circuitry (such as fuses) to eliminate the risk of damaging the IC.
2. Electrical characteristics described in these specifications may vary, depending on temperature, supply voltage, external circuits and other conditions. Therefore, be sure to check all relevant factors, including transient characteristics.
3. GND potential
The potential of the GND pin must be the minimum potential in the system in all operating conditions. Ensure that no pins are at a voltage below the GND at any time, regardless of transient characteristics.
4. Ground wiring pattern
When using both small-signal and large-current GND traces, the two ground traces should be routed separately but connected to a single ground potential within the application in order to avoid variations in the small-signal ground caused by large currents. Also ensure that the GND traces of external components do not cause variations on GND voltage. The power supply and ground lines must be as short and thick as possible to reduce line impedance.
5. Inter-pin shorts and mounting errors
Use caution when orienting and positioning the IC for mounting on printed circuit boards. Improper mounting may result in damage to the IC. Shorts between output pins or between output pins and the power supply or GND pins (caused by poor soldering or foreign objects) may result in damage to the IC.
6. Operation in strong electromagnetic fields
Using this product in strong electromagnetic fields may cause IC malfunction. Caution should be exercised in applications where strong electromagnetic fields may be present.
7. Testing on application boards
When testing the IC on an application board, connecting a capacitor directly to a low-impedance pin may subject the IC to stress. Always discharge capacitors completely after each process or step. The IC's power supply should always be turned off completely before connecting or removing it from a jig or fixture during the evaluation process. To prevent damage from static discharge, ground the IC during assembly and use similar precautions during transport and storage.
8. Power dissipation
If IC is used on condition that the power loss is over the power dissipation, the reliability will become worse by heat up. The power dissipation that is described to the absolute maximum rating in this specification is a value when the heat sink is not populated. In this case it exceed the power dissipation, please consider using the heat sink,etc. Also, be sure to use this IC within a power dissipation range allowing enough of margin.
9. Thermal consideration
Use a thermal design that allows for a sufficient margin in light of the Pd in actual operating conditions. Consider Pc that does not exceed Pd in actual operating conditions. ($P_d \geq P_c$)

$$\left(\begin{array}{ll} T_{jmax} : \text{Maximum junction temperature}=150^{\circ}\text{C}, & T_a : \text{Peripheral temperature } [^{\circ}\text{C}], \\ \theta_{ja} : \text{Thermal resistance of package-ambience}[^{\circ}\text{C}/\text{W}], & P_d : \text{Package Power dissipation } [\text{W}], \\ P_c : \text{Power dissipation } [\text{W}], & V_{cc} : \text{Input Voltage}, \\ V_o : \text{Output Voltage}, & I_o : \text{Load}, & I_b : \text{Bias Current} \end{array} \right)$$

$$\begin{array}{ll} \text{Package Power dissipation} & : P_d (\text{W}) = (T_{jmax} - T_a) / \theta_{ja} \\ \text{Power dissipation} & : P_c (\text{W}) = (V_{cc} - V_o) \times I_o + V_{cc} \times I_b \end{array}$$

10. Vcc pin
Insert a capacitor (capacitor \geq above 0.33 μ F) between the Vcc and GND pins. The appropriate capacitance value varies by application. Be sure to allow a sufficient margin for input voltage levels.

11. Vo Terminal

Please attach an anti-oscillation capacitor between Vo and GND. The capacitance of the capacitor may significantly change due to factors such as temperature changes, which may cause oscillations. Please use a tantalum capacitor or aluminum electrolytic capacitor with favorable characteristics and small external series resistance (ESR) even at low temperatures. The output oscillates regardless of whether the ESR is large or small. Please use the IC within the stable operating region while referring to the ESR characteristics reference data shown in Fig.16. In cases where there are sudden load fluctuations, the large capacitor is recommended. Below figure, it is ESR-to-Io stability Area characteristics, measured by 22μF-ceramic-capacitor and resistor connected in series.

This characteristic is not equal value perfectly to 22μF-aluminum electrolytic capacitor in order to measurement method. Note, however, that the stable range suggested in the figure depends on the IC and the resistance load involved, and can vary with the board's wiring impedance, input impedance, and/or load impedance. Therefore, be certain to ascertain the final status of these items for actual use.

Keep capacitor capacitance within a range of 22μF to 1000μF. It is also recommended that a 0.33μF bypass capacitor be connected as close to the input pin-GND as location possible. However, in situations such as rapid fluctuation of the input voltage or the load, please check the operation in real application to determine proper capacitance.

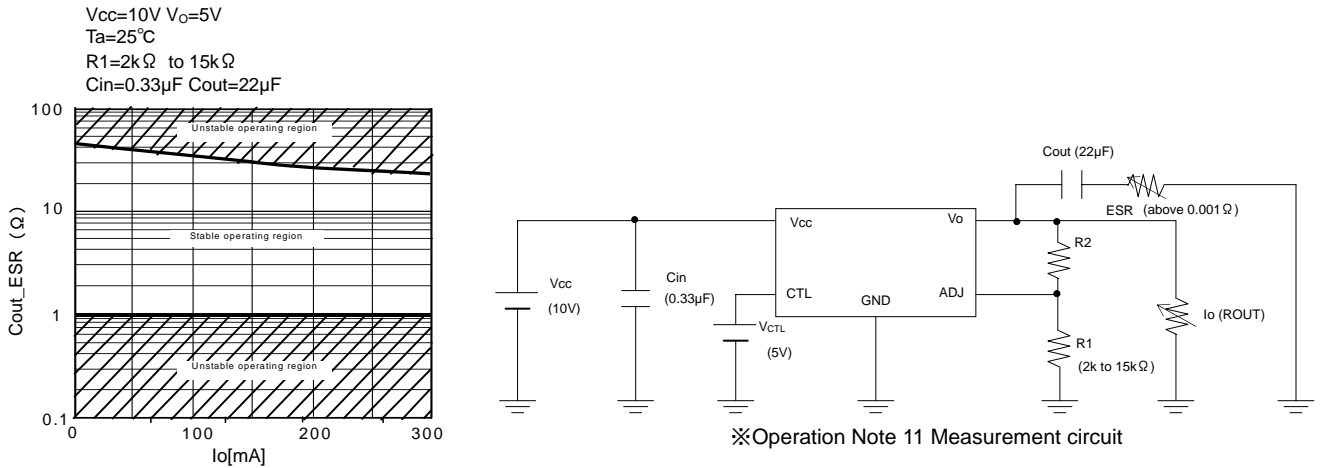

Fig.16 Cout_ESR vs Io (reference data)

12. Over current protection circuit (OCP)

The IC incorporates an integrated over-current protection circuit that operates in accordance with the rated output capacity. This circuit serves to protect the IC from damage when the load becomes shorted. It is also designed to limit output current (without latching) in the event of a large and instantaneous current flow from a large capacitor or other component. These protection circuits are effective in preventing damage due to sudden and unexpected accidents. However, the IC should not be used in applications characterized by the continuous or transitive operation of the protection circuits.

13. Thermal shutdown circuit (TSD)

The IC incorporates a built-in thermal shutdown circuit, which is designed to turn the IC off completely in the event of thermal overload. It is not designed to protect the IC from damage or guarantee its operation. ICs should not be used after this function has activated, or in applications where the operation of this circuit is assumed.

14. Applications or inspection processes where the potential of the Vcc pin or other pins may be reversed from their normal state may cause damage to the IC's internal circuitry or elements. Use an output pin capacitance of 1000μF or lower in case Vcc is shorted with the GND pin while the external capacitor is charged. Insert a diode in series with Vcc to prevent reverse current flow, or insert bypass diodes between Vcc and each pin.

15. Positive voltage surges on Vcc pin

A power zener diode should be inserted between Vcc and GND for protection against voltage surges of more than 50V on the Vcc pin.

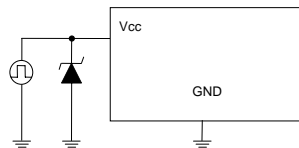

16. Negative voltage surges on V_{CC} pin

A schottky barrier diode should be inserted between V_{CC} and GND for protection against voltages lower than GND on the V_{CC} pin.

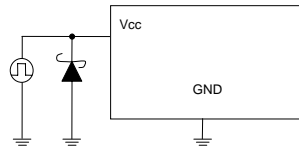

17. Output protection diode

Loads with large inductance components may cause reverse current flow during startup or shutdown. In such cases, a protection diode should be inserted on the output to protect the IC.

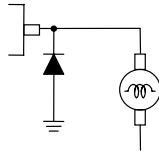

18. Regarding input pins of the IC

This monolithic IC contains P+ isolation and P substrate layers between adjacent elements in order to keep them isolated. PN junctions are formed at the intersection of these P layers with the N layers of other elements, creating parasitic diodes and/or transistors. For example (refer to the figure below):

○When $GND > Pin A$ and $GND > Pin B$, the PN junction operates as a parasitic diode

○When $GND > Pin B$, the PN junction operates as a parasitic transistor

Parasitic diodes occur inevitably in the structure of the IC, and the operation of these parasitic diodes can result in mutual interference among circuits, operational faults, or physical damage. Accordingly, conditions that cause these diodes to operate, such as applying a voltage lower than the GND voltage to an input pin (and thus to the P substrate) should be avoided.

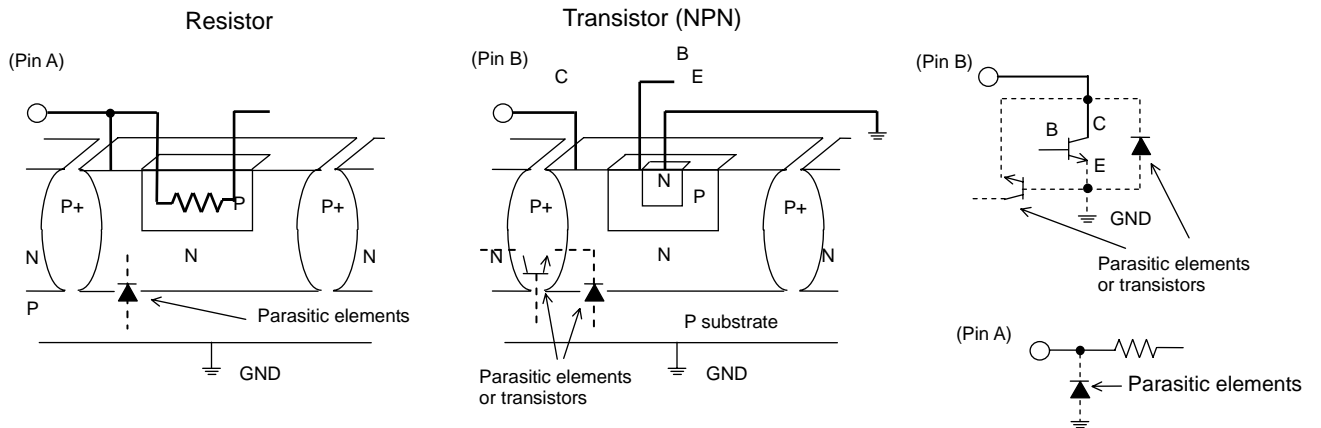

Example of Simple Monolithic IC Architecture

Status of this document

The Japanese version of this document is formal specification. A customer may use this translation version only for a reference to help reading the formal version.

If there are any differences in translation version of this document formal version takes priority.

●Physical Dimension Tape and Reel Information

TO220CP-V5

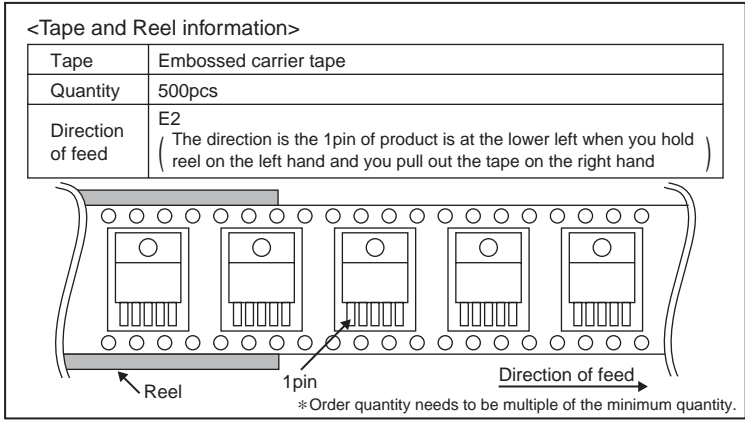
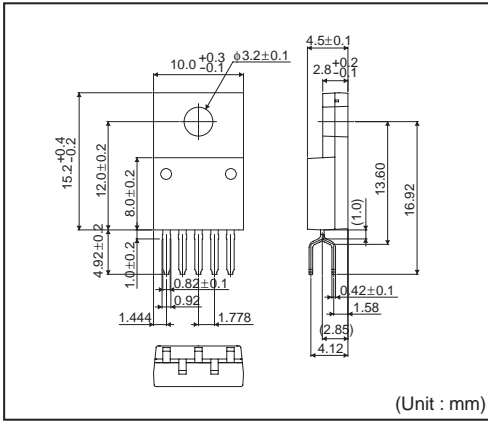

●Marking Diagram

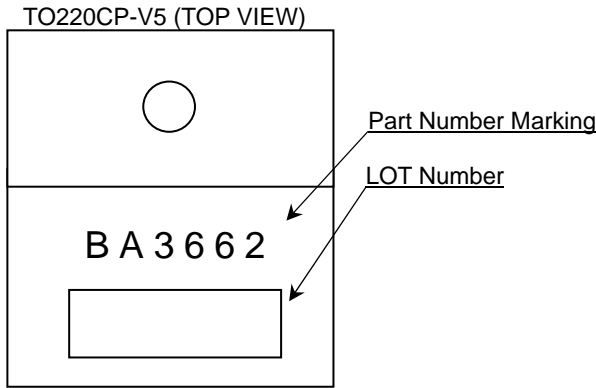

●Revision History

Date	Revision	Changes
26.Jun.2012	001	New Release

Notice

Precaution on using ROHM Products

- Our Products are designed and manufactured for application in ordinary electronic equipments (such as AV equipment, OA equipment, telecommunication equipment, home electronic appliances, amusement equipment, etc.). If you intend to use our Products in devices requiring extremely high reliability (such as medical equipment ^(Note 1), transport equipment, traffic equipment, aircraft/spacecraft, nuclear power controllers, fuel controllers, car equipment including car accessories, safety devices, etc.) and whose malfunction or failure may cause loss of human life, bodily injury or serious damage to property ("Specific Applications"), please consult with the ROHM sales representative in advance. Unless otherwise agreed in writing by ROHM in advance, ROHM shall not be in any way responsible or liable for any damages, expenses or losses incurred by you or third parties arising from the use of any ROHM's Products for Specific Applications.

(Note1) Medical Equipment Classification of the Specific Applications

JAPAN	USA	EU	CHINA
CLASS III	CLASS III	CLASS II b	CLASS III
CLASS IV		CLASS III	

- ROHM designs and manufactures its Products subject to strict quality control system. However, semiconductor products can fail or malfunction at a certain rate. Please be sure to implement, at your own responsibilities, adequate safety measures including but not limited to fail-safe design against the physical injury, damage to any property, which a failure or malfunction of our Products may cause. The following are examples of safety measures:
 - Installation of protection circuits or other protective devices to improve system safety
 - Installation of redundant circuits to reduce the impact of single or multiple circuit failure
- Our Products are designed and manufactured for use under standard conditions and not under any special or extraordinary environments or conditions, as exemplified below. Accordingly, ROHM shall not be in any way responsible or liable for any damages, expenses or losses arising from the use of any ROHM's Products under any special or extraordinary environments or conditions. If you intend to use our Products under any special or extraordinary environments or conditions (as exemplified below), your independent verification and confirmation of product performance, reliability, etc. prior to use, must be necessary:
 - Use of our Products in any types of liquid, including water, oils, chemicals, and organic solvents
 - Use of our Products outdoors or in places where the Products are exposed to direct sunlight or dust
 - Use of our Products in places where the Products are exposed to sea wind or corrosive gases, including Cl₂, H₂S, NH₃, SO₂, and NO₂
 - Use of our Products in places where the Products are exposed to static electricity or electromagnetic waves
 - Use of our Products in proximity to heat-producing components, plastic cords, or other flammable items
 - Sealing or coating our Products with resin or other coating materials
 - Use of our Products without cleaning residue of flux (even if you use no-clean type fluxes, cleaning residue of flux is recommended); or Washing our Products by using water or water-soluble cleaning agents for cleaning residue after soldering
 - Use of the Products in places subject to dew condensation
- The Products are not subject to radiation-proof design.
- Please verify and confirm characteristics of the final or mounted products in using the Products.
- In particular, if a transient load (a large amount of load applied in a short period of time, such as pulse. is applied, confirmation of performance characteristics after on-board mounting is strongly recommended. Avoid applying power exceeding normal rated power; exceeding the power rating under steady-state loading condition may negatively affect product performance and reliability.
- De-rate Power Dissipation (Pd) depending on Ambient temperature (Ta). When used in sealed area, confirm the actual ambient temperature.
- Confirm that operation temperature is within the specified range described in the product specification.
- ROHM shall not be in any way responsible or liable for failure induced under deviant condition from what is defined in this document.

Precaution for Mounting / Circuit board design

- When a highly active halogenous (chlorine, bromine, etc.) flux is used, the residue of flux may negatively affect product performance and reliability.
- In principle, the reflow soldering method must be used; if flow soldering method is preferred, please consult with the ROHM representative in advance.

For details, please refer to ROHM Mounting specification

Precautions Regarding Application Examples and External Circuits

1. If change is made to the constant of an external circuit, please allow a sufficient margin considering variations of the characteristics of the Products and external components, including transient characteristics, as well as static characteristics.
2. You agree that application notes, reference designs, and associated data and information contained in this document are presented only as guidance for Products use. Therefore, in case you use such information, you are solely responsible for it and you must exercise your own independent verification and judgment in the use of such information contained in this document. ROHM shall not be in any way responsible or liable for any damages, expenses or losses incurred by you or third parties arising from the use of such information.

Precaution for Electrostatic

This Product is electrostatic sensitive product, which may be damaged due to electrostatic discharge. Please take proper caution in your manufacturing process and storage so that voltage exceeding the Products maximum rating will not be applied to Products. Please take special care under dry condition (e.g. Grounding of human body / equipment / solder iron, isolation from charged objects, setting of ionizer, friction prevention and temperature / humidity control).

Precaution for Storage / Transportation

1. Product performance and soldered connections may deteriorate if the Products are stored in the places where:
 - [a] the Products are exposed to sea winds or corrosive gases, including Cl₂, H₂S, NH₃, SO₂, and NO₂
 - [b] the temperature or humidity exceeds those recommended by ROHM
 - [c] the Products are exposed to direct sunshine or condensation
 - [d] the Products are exposed to high Electrostatic
2. Even under ROHM recommended storage condition, solderability of products out of recommended storage time period may be degraded. It is strongly recommended to confirm solderability before using Products of which storage time is exceeding the recommended storage time period.
3. Store / transport cartons in the correct direction, which is indicated on a carton with a symbol. Otherwise bent leads may occur due to excessive stress applied when dropping of a carton.
4. Use Products within the specified time after opening a humidity barrier bag. Baking is required before using Products of which storage time is exceeding the recommended storage time period.

Precaution for Product Label

QR code printed on ROHM Products label is for ROHM's internal use only.

Precaution for Disposition

When disposing Products please dispose them properly using an authorized industry waste company.

Precaution for Foreign Exchange and Foreign Trade act

Since our Products might fall under controlled goods prescribed by the applicable foreign exchange and foreign trade act, please consult with ROHM representative in case of export.

Precaution Regarding Intellectual Property Rights

1. All information and data including but not limited to application example contained in this document is for reference only. ROHM does not warrant that foregoing information or data will not infringe any intellectual property rights or any other rights of any third party regarding such information or data. ROHM shall not be in any way responsible or liable for infringement of any intellectual property rights or other damages arising from use of such information or data.:
2. No license, expressly or implied, is granted hereby under any intellectual property rights or other rights of ROHM or any third parties with respect to the information contained in this document.

Other Precaution

1. This document may not be reprinted or reproduced, in whole or in part, without prior written consent of ROHM.
2. The Products may not be disassembled, converted, modified, reproduced or otherwise changed without prior written consent of ROHM.
3. In no event shall you use in any way whatsoever the Products and the related technical information contained in the Products or this document for any military purposes, including but not limited to, the development of mass-destruction weapons.
4. The proper names of companies or products described in this document are trademarks or registered trademarks of ROHM, its affiliated companies or third parties.

General Precaution

1. Before you use our Products, you are requested to carefully read this document and fully understand its contents. ROHM shall not be in any way responsible or liable for failure, malfunction or accident arising from the use of any ROHM's Products against warning, caution or note contained in this document.
2. All information contained in this document is current as of the issuing date and subject to change without any prior notice. Before purchasing or using ROHM's Products, please confirm the latest information with a ROHM sales representative.
3. The information contained in this document is provided on an "as is" basis and ROHM does not warrant that all information contained in this document is accurate and/or error-free. ROHM shall not be in any way responsible or liable for any damages, expenses or losses incurred by you or third parties resulting from inaccuracy or errors of or concerning such information.