



**User Manual**

## **AIMB-215 B1**

**Intel® Celeron J1900/N2930/  
N2807 Mini-ITX with VGA/LVDS/  
DP++ (eDP), 6 COM, Dual LAN, 8  
USB, 2 Mini-PCle, and PCIe x1**

**ADVANTECH**

*Enabling an Intelligent Planet*

---

## Copyright

The documentation and the software included with this product are copyrighted 2014 by Advantech Co., Ltd. All rights are reserved. Advantech Co., Ltd. reserves the right to improve the products described in this manual at any time without notice. No part of this manual may be reproduced, copied, translated or transmitted in any form or by any means without prior written permission from Advantech Co., Ltd. The information provided in this manual is intended to be accurate and reliable. However, Advantech Co., Ltd. assumes no responsibility for its use, nor for any infringements of the rights of third parties, which may result from its use.

## Acknowledgements

IBM and PC are trademarks of International Business Machines Corporation.

Intel® Celeron™ J1900/N2930/N2807 is trademark of Intel Corporation

WinBond is a trademark of Winbond Corporation.

All other product names or trademarks are the property of their respective owners.

# Message to the Customer

## Advantech Customer Services

Every Advantech product is built with the most exact specifications to ensure reliable performance in the harsh and demanding conditions typical of industrial environments. Whether your new Advantech equipment is destined for a laboratory or factory floor, be assured that your product can provide the reliability and ease of operation for which the name Advantech is renowned.

Your satisfaction is our primary concern. A guide to Advantech's customer services is provided below. To ensure that you receive the full benefit of our services, please follow the instructions below.

## Technical Support

We want you to get the maximum performance from your products. Should you encounter any technical difficulties, we are available to provide assistance. Answers to the most frequently asked questions are provided in the product documentation. These answers are typically a lot more detailed than the ones provided over the phone.

So please consult this manual first. If you still cannot find the answer, gather all relevant information or questions that apply to your problem, and with the product close to hand, call your dealer. Our dealers are well trained and ready to provide the support required for you to experience the most from your Advantech products. Most of the problems reported are minor and can be easily solved over the phone.

In addition, free technical support from Advantech engineers is available every business day. We are always willing to give advice on application requirements or specific information regarding the installation and operation of any of our products.

---

# Declaration of Conformity

## FCC Class B

This device complies with the requirements in Part 15 of the FCC regulations:

Operation is subject to the following two conditions:

- This device may not cause harmful interference.
- This device must accept any interference received, including interference that may cause undesired operation.

This equipment has been tested and found to comply with the limits for a Class B digital device, pursuant to Part 15 of the FCC Regulations. These limits are designed to provide reasonable protection against harmful interference when the equipment is operated in a commercial environment. This equipment generates, uses, and can radiate radio frequency energy and, if not installed and used in accordance with the instruction manual, may cause harmful interference to radio communications. Operation of this device in a residential area is likely to cause harmful interference, in which case users are required to correct the interference at their own expense. The user is advised that any equipment changes or modifications not expressly approved by the party responsible for compliance would void compliance with the FCC regulations and, therefore, the user's authorization to operate the equipment.

**Caution!** *There is a risk of a new battery exploding if incorrectly installed. Do not attempt to recharge, force open, or heat the battery. Replace the battery only with the same or equivalent type recommended by the manufacturer. Discard used batteries according to the manufacturer's instructions.*



# Memory Compatibility

## AIMB-215 B1 Memory Compatibility List

Brand	Size	Speed	Type	ECC	Vendor PN	Memory	Advantech PN	Result
Tran-scend	2GB	DDR3 1333	SODIMM DDR3	N	TS256MSK64W3N	SEC 234 HYK0 K4B2G0846D		PASS
Apacer	4GB	DDR3 1333	SODIMM DDR3	N	78.B2GCV.AT00C	MICRON2XE22D9QBJ MICRON 4JE77 D9QBJ	96SD3L-4G1333NN-AP	PASS
Apacer	2GB	DDR3 1600	SODIMM DDR3	N	78.A2GCR.AT00C	MICRON IYM22 D9PFJ (256x8)		PASS
Apacer	4GB	DDR3 1600	SODIMM DDR3	N	78.B2GCR.AF10C	HYNIX H5TC2G83EFR		PASS
Apacer	4GB	DDR3 1600	SODIMM DDR3	N	78.B2GCZ.AT00C	MICRON 2QE22 D9QBJ		PASS
Tran-scend	4GB	DDR3 1600	SODIMM DDR3	N	TS512MSK64W6H	SEC 231 HYK0 K4B4G0846B	96SD3L-4G1600NN-TR	PASS
AQD	4GB	DDR3 1600	SODIMM DDR3	N	653555-0007	SEC 316 XYK0 K4B4G0846B	AQD-SD3L4GN16-SG	PASS
AQD	2GB	DDR3 1600	SODIMM DDR3	N	665205-0397	SEC 310 XYKO K4B2G084GD	AQD-SD3L2GN16-SQ	PASS
AQD	2GB	DDR3 1600	SODIMM DDR3	N	201403504691	HYNIX H5TC2G83EFR	AQD-SD3L2GN16-HQ	PASS

## Ordering Information

P/N	CPU	Memory	DP++/eDP	CRT	LVDS	GbE LAN	COM	SATA II	USB3.0/2.0	MiniPCle	TPM	AMP	PClex1	Thermal solution
AIMB-215D-S6B1E	J1900	2	1/(1)	1	1	2	6	2	1/7	2 (1 x F/S; 1 x H/S); H/S miniPCle colay PClex1	(1)	(2 x 6W)	1; PClex1 colay H/S miniPCle	Passive
AIMB-215N-S6B1E	N2930	2	1/(1)	1	1	2	6	2	1/7	2 (1 x F/S; 1 x H/S); H/S miniPCle colay PClex1	(1)	(2 x 6W)	1; PClex1 colay H/S miniPCle	Passive
AIMB-215U-S6B1E (w/o SUSI-Access)	N2807	1	1/(1)	1	0	1	2	1	1/3	1 x F/S	(1)	(2 x 6W)	1	Passive
AIMB-215L-S6B1E (w/o SUSI-Access)	J1900	2	1/(1)	1	0	1	2	1	1/3	1 x F/S	(1)	(2 x 6W)	1	Passive

\* ( ) is not populated when MP

---

## Product Warranty (2 years)

Advantech warrants the original purchaser that its products will be free from defects in materials and workmanship for two years from the date of purchase.

This warranty does not apply to any products that have been repaired or altered by persons other than repair personnel authorized by Advantech, or products that have been subject to misuse, abuse, accident, or improper installation. Advantech assumes no liability under the terms of this warranty as a consequence of such events.

Because of Advantech's high quality-control standards and rigorous testing, most customers never need to use our repair service. If an Advantech product is defective, it will be repaired or replaced at no charge during the warranty period. For out-of-warranty repairs, users will be billed according to the cost of replacement materials, service time, and freight. Please consult your dealer for more details.

If you believe your product is defective, please follow the steps listed below.

1. Collect all information about the problem encountered (for example, CPU speed, Advantech products used, other hardware and software used, etc.). Note anything abnormal and list any onscreen messages encountered when the problem occurs.
2. Call your dealer and describe the problem. Please have your manual, product, and any relevant information readily available.
3. If your product is diagnosed as defective, obtain a return merchandise authorization (RMA) number from your dealer. This allows us to process your return more quickly.
4. Carefully pack the defective product, a completed Repair and Replacement Order Card, and proof of the purchase date (such as a photocopy of your sales receipt) in a shippable container. Products returned without a proof of purchase date are not eligible for our warranty service.
5. Write the RMA number clearly on the outside of the package and ship the product prepaid to your dealer.

## Initial Inspection

Before installing the motherboard, please ensure that the following items are included in your shipment:

- 1x AIMB-215 B1 Intel® Celeron™ J1900/N2930/N2807 Mini-ITX motherboard
- 1 x SATA HDD cable
- 1 x SATA power cable
- 1 x Serial port cable (1 to 4), for AIMB-215 B1 D/N SKU only
- 2 x Serial port cable (1 to 1)
- 1 x I/O port bracket
- 1 x startup manual
- 1 x driver CD
- 1 x warranty card
- 1 x on-board CPU heat sink

If any of these items are missing or damaged, contact your distributor or sales representative immediately. All AIMB-215 B1 devices are mechanically and electrically inspected before shipment. Thus, your product should be free of marks and scratches and in perfect working order upon receipt. While unpacking AIMB-215 B1, check the product for signs of shipping damage (for example, a damaged box, scratches, dents, etc.). If the device is damaged or fails to meet the specifications, notify our service department or your local sales representative immediately. Please also notify the carrier. Retain the shipping carton and packing material for inspection by the carrier. After this inspection, we will make arrangements to repair or replace the unit.





# Contents

<b>Chapter 1</b>	<b>General Information .....</b>	<b>1</b>	
1.1	Introduction .....	2	
1.2	Features .....	2	
1.3	OS and BIOS Compatibility .....	2	
1.4	Specifications .....	3	
1.4.1	System .....	3	
1.4.2	Memory .....	3	
1.4.3	Input/Output .....	3	
1.4.4	Graphics .....	3	
1.4.5	Ethernet LAN .....	3	
1.4.6	Industrial Features .....	4	
1.4.7	Mechanical and Environmental Specifications .....	4	
1.5	Jumpers and Connectors .....	4	
	Table 1.1: Connector/Header List .....	4	
1.6	Board Layout: Jumper and Connector Locations .....	6	
	Figure 1.1 Jumper and Connector Locations .....	6	
	Figure 1.2 I/O Connectors .....	6	
1.7	AIMB-215 B1 Board Diagram .....	7	
	Figure 1.3 AIMB-215 B1 Board Diagram .....	7	
1.8	Safety Precautions .....	8	
1.9	Jumper Options .....	9	
1.9.1	Setting Jumpers .....	9	
1.9.2	CMOS Mode Selection (JRTCTEST1) .....	9	
	Table 1.2: CMOS Mode Selection (JRTCTEST1) .....	9	
1.9.3	COM2 RS-232/422/485 Mode Selector (JSETCOM3) .....	10	
	Table 1.3: COM2 RS-232/422/485 Mode Selector (JSETCOM3) .	10	
	Table 1.4: COM3 RS-232/422/485 Mode Selector (JSETCOM3) .	10	
1.9.4	LVDS Panel Voltage Selection (JLVDS1 + JLVDS2) .....	11	
	Table 1.5: LVDS Panel Voltage Selection (JLVDS1 + JLVDS2) .....	11	
1.9.5	PSON1: ATX and AT Mode Selector .....	11	
	Table 1.6: PSON1: ATX and AT Mode Selector .....	11	
1.9.6	JOBS1 + JWDT1: OBS Beep and Watchdog Timer Output .....	12	
	Table 1.7: JOBS1 + JWDT1: OBS Beep and Watchdog Timer	Output .....	12
1.9.7	Case Open Pin Header Selection (JCASEOP_SW1) .....	12	
	Table 1.8: Case Open Pin Header Selection (JCASEOP_SW1) ...	12	
1.9.8	Power Switch/HDD LED/SMBus/Speaker Pin Header (JFP1 +	JFP2) .....	12
	Table 1.9: Power Switch/HDD LED/SMBus/Speaker Pin Header	(JFP1 + JFP2) .....	12
1.9.9	EDP Panel Voltage Selection (JEDP1 + JEDP2) (BOM Optional) .	13	
	Table 1.10: EDP Panel Voltage Selection (JEDP1 + JEDP2) (op-	optional) .....	13
1.9.10	JEIDA/VESA Selection (JLVDS_VCON1) .....	13	
	Table 1.11: JEIDA/VESA Selection (JLVDS_VCON1) .....	13	
1.9.11	RS-485/422 Terminal Resistor Jumper (SW_422_1) .....	14	
	Table 1.12: RS-485/422 Terminal Resistor Jumper (SW_422_1) .....	14	
<b>Chapter 2</b>	<b>Connecting Peripherals .....</b>	<b>15</b>	

2.1	Introduction .....	16
2.2	LAN and USB Ports (LAN1/2, USB0102/USB0304/USB0506/USB0708) ..	16
	Table 2.1: LAN LED Indicators .....	16
2.3	VGA Connector (VGA1).....	17
2.4	Serial Ports (COM1 ~ COM6) .....	18
2.5	PS/2 Keyboard and Mouse Connector (KBMS1).....	19
2.6	Display Port Connector (DP1).....	19
2.7	System FAN Connector (SYSFAN1/2) .....	20
2.8	Front Panel Connectors (JFP3/JFP1 + JFP2) .....	20
	2.8.1 ATX Soft Power Switch (JFP1 + JFP2/PWR_SW) .....	21
	2.8.2 Reset (JFP1 + JFP2/RESET) .....	21
	2.8.3 HDD LED (JFP1 + JFP2/HDDLED).....	21
	2.8.4 External Speaker (JFP1 + JFP2/SPEAKER).....	21
	2.8.5 Power LED and Keyboard Lock Connector (JFP3/PWR_LED and KEY LOCK).....	21
	Table 2.2: ATX Power Supply LED Status (AT power not supported) .....	21
2.9	Line-Out Connector (AUDIO1).....	22
2.10	Serial ATA Interface (SATA1/2) & SATADOM Power Pin Header (JSATAPWR1).....	22
	Table 2.3: SATADOM Power Pin Header (JSATAPWR1) .....	23
2.11	PCI-Express x1 Slot (PCIEX1_1).....	23
2.12	Front Panel Audio Connector (FPAUDIO1) .....	24
2.13	ATX 12V Power Connector (ATX12V1).....	24
2.14	SPI Flash Connector(SPI_CN1) .....	25
2.15	LVDS Backlight Inverter Power Connector (INV1).....	25
2.16	LVDS Connector (LVDS1) .....	26
2.17	General Purpose I/O Connector (GPIO1).....	27
2.18	CMOS Battery Wafer Box (BAT1).....	27
2.19	SPI BIOS Socket (SPI1) .....	28
2.20	SPDIF Interface Pin Header (SPDIF_OUT1).....	28
2.21	Audio Amplifier Output Pin Header (JAMP1) (BOM Optional).....	29
2.22	ATX Power Supply (5VSB) Connector (ATX_5VSB1).....	29
2.23	SATA Power Connector (SATA_PWR1/2).....	30
2.24	Case Open Pin Header (JCASE1).....	30
2.25	DDR3L SODIMM Socket (DIMMA1/B1).....	31
2.26	Mini-PCIe and mSATA Connector (MINIPCIE1).....	32
2.27	Mini-PCIe Connector (MINIPCIE2) .....	32
2.28	Low Pin Count Interface Header (LPC1) .....	33
2.29	RTC Reset Pin Header (JRTCTEST1) .....	33
2.30	eDP Connector (eDP1) (BOM Optional).....	34
2.31	eDP Backlight Inverter Power Connector (INV-EDP1) (BOM Optional) ..	34
2.32	SIM Card Holder (SIM2) .....	35

## Chapter 3 BIOS Operation ..... 37

3.1	Introduction .....	38
3.2	BIOS Setup .....	38
	3.2.1 Main Menu .....	39
	3.2.2 Advanced BIOS Features .....	40
	3.2.3 Chipset.....	63
	3.2.4 Security.....	71
	3.2.5 Boot .....	72
	3.2.6 Save and Exit.....	73

## Chapter 4 Software and Service Introduction.. 75

4.1	Introduction .....	76
-----	--------------------	----

4.2	Value-Added Software Services .....	76
4.2.1	Software API .....	76
4.2.2	Software Utility .....	78
<b>Chapter 5</b>	<b>Chipset Software Install Utility .....</b>	<b>79</b>
5.1	Before Installation .....	80
5.2	Introduction .....	80
<b>Chapter 6</b>	<b>VGA Setup .....</b>	<b>81</b>
6.1	Introduction .....	82
6.2	Windows 7/8.1 .....	82
<b>Chapter 7</b>	<b>LAN Configuration .....</b>	<b>83</b>
7.1	Introduction .....	84
7.2	Features .....	84
7.3	Installation .....	84
7.4	Windows 7/8.1 Driver Setup (Realtek 8111E).....	84
<b>Chapter 8</b>	<b>XHCI Driver Installation .....</b>	<b>85</b>
8.1	Introduction .....	86
8.2	Installation .....	87
<b>Appendix A</b>	<b>Programming the Watchdog Timer ..</b>	<b>89</b>
A.1	Programming the Watchdog Timer .....	90
A.1.1	Watchdog Timer Overview .....	90
A.1.2	Programming the Watchdog Timer .....	90
	Table A.1: Watchdog Timer Registers .....	92
A.1.3	Example Program .....	93
<b>Appendix B</b>	<b>I/O Pin Assignments .....</b>	<b>97</b>
B.1	DC-IN Adaptor Connector (DCIN1) .....	98
B.2	Display Port Connector (DP1) .....	98
B.3	eDP Panel Voltage Selection (JEDP-1 + JEDP-2) (BOM Optional).....	99
B.4	VGA Connector (VGA1) .....	99
B.5	Serial ATA Interface Connector (SATA2).....	100
B.6	SATADOM Power Pin Header (JSATAPWR1) .....	100
B.7	Serial ATA Interface Connector (SATA1).....	100
B.8	CMOS Battery Wafer Box (BAT1).....	101
B.9	System Fan Connector (SYSFAN2).....	101
B.10	USB3.0 + USB2.0 Stack Connector (USB0102).....	101
B.11	SPI BIOS Socket (SPI1).....	102
B.12	USB2.0 * 2 Stack Connector (USB0304).....	102
B.13	COM1 Box Header (COM1).....	103
B.14	Watchdog Timer Output and OBS Beep (JOBS1 + JWDT1) .....	103
B.15	RJ45 (LAN1 + LAN2) Connector (LAN12) .....	104
B.16	SPDIF Interface Pin Header (SPDIF_OUT1) .....	104
B.17	HD Analog Audio Interface (AUDIO1).....	105
B.18	Front Panel Audio Pin Header (FPAUD1).....	105
B.19	Audio Amplifier Output Pin Header (JAMP1) (BOM Optional) .....	105

B.20	LVDS VESA and JEIDA Format Pin Header .....	106
B.21	LVDS Panel Connector (LVDS1).....	106
B.22	Dual-Port USB2.0 Box Header (USB0506).....	107
B.23	LVDS Panel Voltage Selection (JLVDS1 + JLVDS2).....	107
B.24	COM6 RI# Selection Pin Header (JSETCOM6_V1) .....	108
B.25	LVDS Backlight Inverter Power Connector (INV1).....	108
B.26	8-bit General Purpose I/O Pin Header (GPIO1).....	108
B.27	COM3 ~ COM6 Box Header (COM3456) .....	109
B.28	AT/ATX Mode Selection (PSON1).....	110
B.29	ATX Power Supply(5VSB) Connector (ATX_5VSB1).....	110
B.30	COM3 RS232, RS422, and RS485 Selection Pin Header (JSETCOM3) ... 111	
B.31	SATA Power Connector (SATA_PWR1).....	111
B.32	COM2 Pin Header (COM2).....	112
B.33	System Fan Connector (SYSFAN1) .....	112
B.34	Case Open Selection Pin Header (JCASEOP_SW1).....	112
B.35	Case Open Pin Header (JCASE1).....	113
B.36	PS/2 Keyboard and PS/2 Mouse Connector (KBMS1).....	113
B.37	Mini-PCIe Connector (MINIPCI2) .....	114
B.38	Mini-PCIe and mSATA Connector (MINIPCI1).....	115
B.39	Low Pin Count Interface Header (LPC1) .....	116
B.40	BIOS Flash Pin Header (SPI_CN1).....	117
B.41	RTC Reset Pin Header (JRTCTEST1) .....	117
B.42	SATA Power Connector (SATA_PWR2).....	117
B.43	Dual-Port USB2.0 Pin Header (USB0708).....	118
B.44	eDP Connector (eDP1) (BOM Optional).....	118
B.45	Power LED and Keyboard Lock Pin Header (JFP3).....	119
B.46	Power Switch/HDD LED/SMBus/Speaker Pin Header (JFP1 + JFP2) .	119
B.47	LVDS2 Control Signal Pin Header (LVDS2) (BOM Optional) .....	119
B.48	eDP Backlight Inverter Power Connector (INV-EDP1) (BOM Optional)	120
B.49	ATX 12 V Power Supply Connector (ATX12V1).....	120
B.50	SIM Card Holder (SIM2) .....	120
B.51	RS-485/422 Terminal Resistor Jumper (SW_422_1) .....	121

# Chapter 1

General Information

---

## 1.1 Introduction

The AIMB-215 B1 with Intel® Celeron™ J1900/N2930/N2807 processor is designed for industrial applications that require enhanced computing performance and power management capabilities. The motherboard features an onboard Intel® Celeron™ J1900/N2930/N2807 quad-core 2.0/1.83 and dual-core 1.58 GHz CPU with DDR3L 1333MHz of up to 8 GB.

The AIMB-215 B1 offers rich I/O connectivity with one USB 3.0 and nine USB 2.0 ports, as well as six COM ports integrated in a standard 170 x 170 mm form factor. The system also supports dual display for LVDS, DP++ and VGA. AIMB-215 B1 also features numerous connectivity and expansion options, including PCIe x1, 8-bit GPIO, two SATA II 3GB/s connectors, an optional TPM security feature, and two Mini-PCIe expansion slots for easy integration. A dual Intel® chipset and 10/100/1000 Mbps Ethernet port are also provided to deliver high-speed networking.

AIMB-215 B1 is powered by the newest Intel® Celeron™ processor, which is built on 22nm process technology. The thermal design power rating for the Intel N2807 dual-core architecture is only 4.3 W, and that for the quad-core N2930/J1900 design is only 7.5 W/10 W, allowing additional power reductions, system compressions, and performance improvements to be implemented in the future. All the features described above are incorporated into a space-saving, power-efficient, and cost-effective Mini-ITX form factor.

## 1.2 Features

- Supports Intel® Celeron™ J1900, N2930, and N2807 processors
- Two 204-pin SODIMM, up to 8 GB DDR3L, and 1333 MHz SDRAM
- Supports 1 PCIe x1 and two Mini-PCIe expansion ports, six serial ports, 8 USB ports, and two SATA II ports
- Lower total ownership costs with DC12-V functionality; supports 24-bit dual-channel LVDS
- Onboard TPM 1.2 support (optional)
- Supports a dual-channel 6 W amplifier (optional)
- Supports embedded software APIs and utilities

## 1.3 OS and BIOS Compatibility

The AIMB-215 B1 BIOS supports OS in legacy mode for 32 and 64 bit, and supports OS in UEFI mode for 64-bit.

## 1.4 Specifications

### 1.4.1 System

- **CPU:** Intel® Celeron™ J1900/N2930/N2807
- **BIOS:** SPI 16-Mbit BIOS
- **SATA hard disk drive interface:** Two onboard SATA connectors with a data transmission rate of up to 300 MB

**Note!** *mSATA support is only available when SATA 2 is not in use; mSATA and SATA2 cannot be used concurrently.*



### 1.4.2 Memory

- **RAM:** Up to 8 GB in two-slot 204-pin SODIMM sockets. Supports dual-channel DDR3L (low voltage) SODIMM 1.35 V modules of up to 1333 MHz

**Note!** *AIMB-215 B1 supports 1.35 V memory only. Users must install the memory modules on the DIMMA 1 socket first.*



### 1.4.3 Input/Output

- **PCI bus:** One PCIe x1 slot, one full size MiniPCIe and one half size MiniPCIe socket
- **Serial ports:** Six serial ports; COM3 comprises RS-232/422/485 and five RS-232 serial ports
- **Keyboard and PS/2 mouse connector:** Supports one standard PS/2 keyboard and one standard PS/2 mouse (onboard six-pin wafer box)
- **USB port:** Supports one USB 3.0 port with a transmission rate of up to 5Gbps and seven USB 2.0 ports with transmission rates of up to 480 Mbps
- **GPIO connector:** One 8-bit general purpose input/output

**Note!** *Half size MiniPCIe support is only available when PCIe x1 is not in use; Half size MiniPCIe and PCIe x1 cannot be used concurrently.*



### 1.4.4 Graphics

- **Controller:** Embedded Gen7, Gfx frequency 688/313/313 MHz for J1900 / N2930/N2807
- **Display memory:** Dynamically shared system memory of up to 224 MB
- **VGA:** Supports a display resolution of up to 2560 x 1600 @ 60 Hz
- **LVDS:** Supports a display resolution of up to 1920 x 1200 @ 60 Hz
- **DisplayPort 1.2:** Supports up to 2560 x 1600 @ 60 Hz

### 1.4.5 Ethernet LAN

- Supports dual 10/100/1000 Mbps Ethernet port (s) via PCI Express x1 bus, which provides a data transmission rate of 500 MB/s
- **Controller:** LAN1: Realtek 8111E; LAN2: Realtek 8111E

## 1.4.6 Industrial Features

- **Watchdog timer:** Can generate a system reset. The watchdog timer is programmable, with each unit equal to one second or one minute (255 levels)

## 1.4.7 Mechanical and Environmental Specifications

- **Operating temperature:** 0 ~ 60 °C (32 ~ 140 °F, depending on the CPU)
- **Storage temperature:** -40 ~ 85 °C (-40 ~ 185 °F)
- **Humidity:** 5 ~ 95% non-condensing
- **Power supply voltage:** +12 V
- **Power consumption:**+12 V @ 2.03 A (Intel J1900 2.0 GHz processor/DDR3L 1333 MHz 4 GB x 2)
- **Board size:** 170 x 170 mm (6.69 x 6.69")
- **Board weight:** 0.365 kg

## 1.5 Jumpers and Connectors

The AIMB-215 B1 motherboard is equipped with connectors for linking the board to external devices such as hard disk drives and a keyboard. The board also features several jumpers for configuring the system according to specific applications.

The function of each board jumper and connector is listed in the table below. The procedure for setting jumpers is explained in subsequent sections of this chapter. Instructions for connecting external devices to the motherboard are provided in Chapter 2.

**Table 1.1: Connector/Header List**

	<b>Description</b>	<b>Part Reference</b>
1	DC-IN adaptor connector	DCIN1
2	Display Port connector	DP1
3	eDP panel voltage selection	JEDP-1+JEDP-2
4	VGA connector	VGA1
5	Serial ATA interface connector	SATA2
6	SATADOM power pin header	JSATAPWR1
7	Serial ATA interface connector	SATA1
8	CMOS battery wafer box	BAT1
9	System fan connector	SYSFAN2
10	USB 3.0 + USB 2.0 stack connector	USB0102
11	SPI BIOS socket	SPI1
12	USB 2.0 * 2 stack connector	USB0304
13	COM1 box header	COM1
14	Watchdog timer output and OBS beep	JOBS1+JWDT1
15	RJ45(LAN 1+ LAN 2) connector	LAN12
16	SPDIF interface pin header	SPDIF_OUT1
17	HD analog audio interface	AUDIO1
18	Front-panel audio pin header	FPAUD1
19	Audio amplifier output pin header	JAMP1
20	PCI-Express x1 slot	PCIEX1_1



**Table 1.1: Connector/Header List**

21	LVDS VESA, JEIDA format selection pin header	JLVDS_VCON1
22	LVDS panel connector	LVDS1
23	Dual-port USB2.0 pin header	USB0506
24	DDR3L SODIMM socket	DIMMB1
25	LVDS panel voltage selection	JLVDS1+JLVDS2
26	COM6 RI# selection pin header	JSETCOM6_V1
27	LVDS backlight inverter power connector	INV1
28	8-bit general purpose I/O pin header	GPIO1
29	COM 3 ~ COM 6 box header	COM3456
30	AT/ATX mode selection	PSON1
31	ATX power supply (5VSB) connector	ATX_5VSB1
32	COM3 RS232,RS422,RS485 selection pin header	JSETCOM3
33	SATA power connector	SATA_PWR1
34	COM2 box header	COM2
35	System fan connector	SYSFAN1
36	Case open selection pin header	JCASEOP_SW1
37	Case open pin header	JCASE1
38	PS/2 keyboard and PS/2 mouse connector	KBMS1
39	Mini-PCIe connector	MINIPCI2
40	Mini-PCIe, mSATA connector	MINIPCI1
41	DDR3L SODIMM socket	DIMMA1
42	Low pin count interface header	LPC1
43	BIOS flash pin header	SPI_CN1
44	RTC reset pin header	JRTCTEST1
45	SATA power connector	SATA_PWR2
46	Dual-port USB2.0 pin header	USB0708
47	eDP connector	eDP1
48	Power LED and keyboard lock pin header	JFP3
49	Power switch/HDD LED/SMBus/Speaker pin header	JFP1+JFP2
50	LVDS2 control signal pin header	LVDS2
51	eDP backlight inverter power connector	INV-EDP1
52	ATX 12-V power supply connector	ATX12V1
53	SIM card holder	SIM2
54	RS-485/422 terminal resistor jumper	SW_422_1

## 1.6 Board Layout: Jumper and Connector Locations

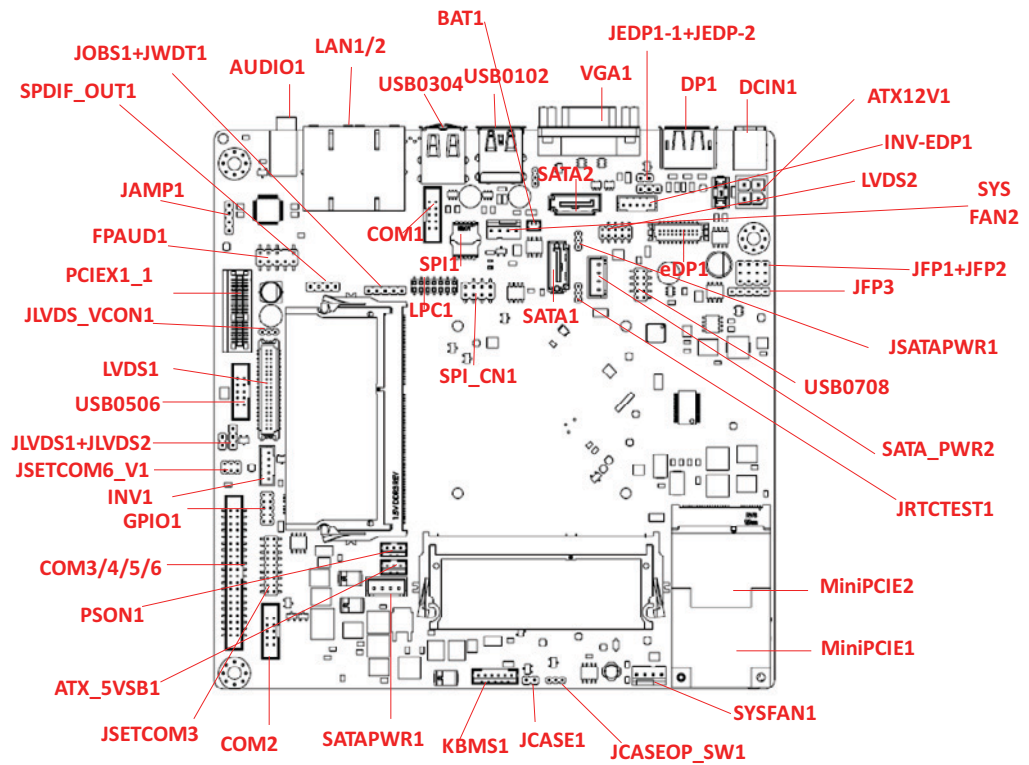

Figure 1.1 Jumper and Connector Locations

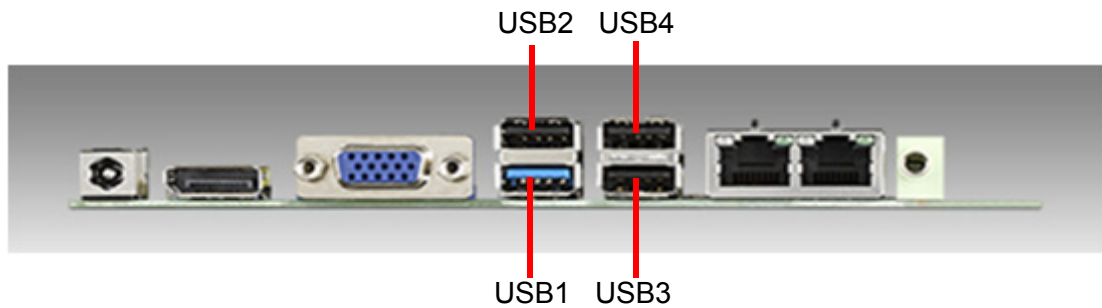
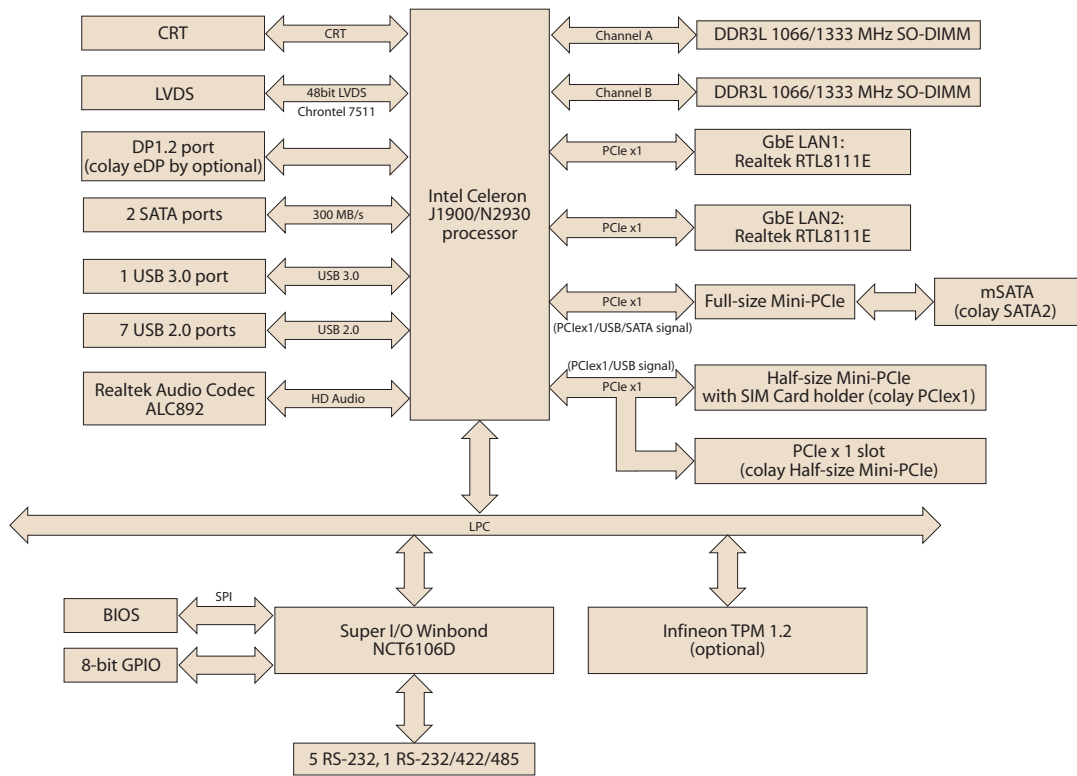

Figure 1.2 I/O Connectors

## 1.7 AIMB-215 B1 Board Diagram



**Figure 1.3 AIMB-215 B1 Board Diagram**

---

## 1.8 Safety Precautions

**Warning!** *Always completely disconnect the power cord from the chassis when working with the hardware. Do not connect devices while the power is on. Sensitive electronic components can be damaged by sudden power surges. Only experienced electronics personnel should open the PC chassis.*



**Caution!** *Always ground yourself to remove any static charge before touching the motherboard. Modern electronic devices are very sensitive to electrostatic discharges. As a safety precaution, use a grounding wrist strap at all times. Place all electronic components on a static-dissipative surface or in a static-shielded bag when not in the chassis.*



**Caution!** *The computer is provided with a battery-powered real-time clock circuit. There is a danger of explosion if the battery is incorrectly replaced. Replace only with the same or equivalent type recommended by the manufacturer. Discard used batteries according to the manufacturer's instructions.*



**Caution!** *There is a danger of a new battery exploding if incorrectly installed. Do not attempt to recharge, force open, or heat the battery. Replace the battery only with the same or equivalent type recommended by the manufacturer. Discard used batteries according to the manufacturer's instructions.*



## 1.9 Jumper Options

This section provides instructions on how to configure the motherboard by setting jumpers, and also outlines the default motherboard settings and options for each jumper.

### 1.9.1 Setting Jumpers

The motherboard can be configured according to the application requirements with the setting of jumpers. A jumper is a metal bridge used to close an electrical circuit. Jumpers typically consist of two metal pins and a small metal clip (often protected by a plastic cover) that slides over the pins to connect them. To “close” (or turn ON) a jumper, connect the pins with the clip. To “open” (or turn OFF) a jumper, simply remove the clip. Some jumpers comprise a set of three pins, labeled 1, 2, and 3. With these jumpers, simply connect either Pins 1 and 2, or Pins 2 and 3. A pair of needle-nose pliers may be necessary for setting jumpers.

### 1.9.2 CMOS Mode Selection (JRTCCTEST1)

The AIMB-215 B1 motherboard contains a jumper that can erase CMOS data and reset the system BIOS information. This jumper is typically set with Pins 1 and 2 being closed. To reset the CMOS data, set J1 to Pins 2 and 3 as closed for a few seconds before moving the jumper back to Pins 1 and 2 as closed. This procedure resets the CMOS to its default settings.

**Table 1.2: CMOS Mode Selection (JRTCCTEST1)**

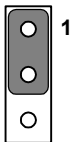
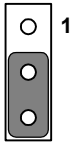
Function	Setting
Normal (Default)	
Clear CMOS	

### 1.9.3 COM2 RS-232/422/485 Mode Selector (JSETCOM3)

Users can select between the RS-232/422/485 modes for COM3 using JSETCOM3. The default setting is “RS-232”.

**Table 1.3: COM2 RS-232/422/485 Mode Selector (JSETCOM3)**

Function	Setting
Set COM3 as RS-232 (default)	
Set COM3 as RS-422	
Set COM3 as RS-485	

**Table 1.4: COM3 RS-232/422/485 Mode Selector (JSETCOM3)**

Function	Jumper Settings
RS-232*	(5-6) + (7-9) + (8-10) + (13-15) + (14-16) closed
RS-422	(3-4) + (9-11) + (10-12) + (15-17) + (16-18) closed
RS-485	(1-2) + (9-11) + (10-12) + (15-17) + (16-18) closed
*default	

## 1.9.4 LVDS Panel Voltage Selection (JLVDS1 + JLVDS2)

**Table 1.5: LVDS Panel Voltage Selection (JLVDS1 + JLVDS2)**

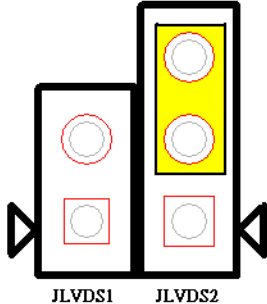
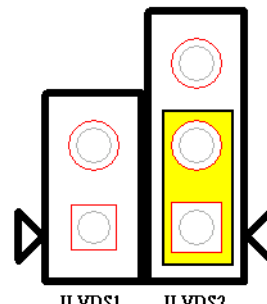
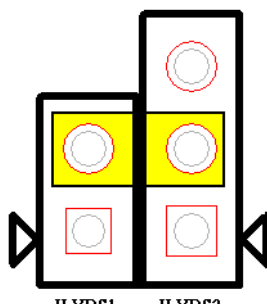
Function	Settings
Set the LVDS panel as +5 V	
Set LVDS panel as +3.3 V (default)	
Set the LVDS panel as +12 V	

## 1.9.5 PSON1: ATX and AT Mode Selector

**Table 1.6: PSON1: ATX and AT Mode Selector**

Closed Pins	Result
1-2	AT Mode
2-3*	ATX Mode

\*Default

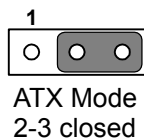
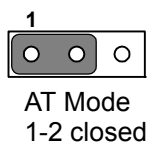

## 1.9.6 JOBS1 + JWDT1: OBS Beep and Watchdog Timer Output

**Table 1.7: JOBS1 + JWDT1: OBS Beep and Watchdog Timer Output**

Closed Pins	Result
2-3*	Watchdog reset
4-5*	OBS alarm

\*default

Function	Settings
Watchdog Timer Output (2-3) (default) OBS BEEP (4-5) (default)	<p>1 2 3 4 5</p>
Watchdog Timer disabled (1-2) OBS BEEP (4-5) (default)	<p>1 2 3 4 5</p>

## 1.9.7 Case Open Pin Header Selection (JCASEOP\_SW1)

**Table 1.8: Case Open Pin Header Selection (JCASEOP\_SW1)**

Function	Settings
Normal Close (default)	<p>1 2 3</p>
Normal Open	<p>1 2 3</p>

## 1.9.8 Power Switch/HDD LED/SMBus/Speaker Pin Header (JFP1 + JFP2)

**Table 1.9: Power Switch/HDD LED/SMBus/Speaker Pin Header (JFP1 + JFP2)**

Function	Settings
JFP1 (7-10) (default)	<p>PWR_BTN RST_BTN HDD_LED SM_BUS SPEAKER</p>



### 1.9.9 EDP Panel Voltage Selection (JEDP1 + JEDP2) (BOM Optional)

**Table 1.10: EDP Panel Voltage Selection (JEDP1 + JEDP2) (optional)**

Function	Settings
Set the EDP Panel as +5 V	
Set the EDP panel as +3.3 V (default)	
Set the EDP panel as +12 V	

### 1.9.10 JEIDA/VESA Selection (JLVDS\_VCON1)

**Table 1.11: JEIDA/VESA Selection (JLVDS\_VCON1)**

Function	Settings
Pull high to +V5. (JEIDA or VESA base on panel definition)	
Pull down to GND (default) (JEIDA or VESA base on panel definition)	

## 1.9.11 RS-485/422 Terminal Resistor Jumper (SW\_422\_1)

**Table 1.12: RS-485/422 Terminal Resistor Jumper (SW\_422\_1)**

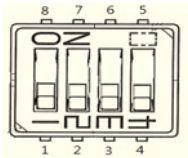
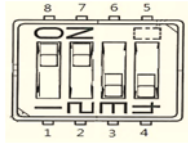
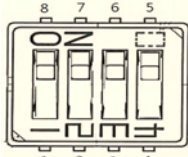
Function	Settings
Default	
Add RS-485 terminator	
Add RS-422 terminator	

# Chapter 2

Connecting  
Peripherals

## 2.1 Introduction

Most of the device connectors can be accessed from the top of the board during installation in the chassis. If the system is installed with several cards or the chassis is packed, partial removal of the card may be necessary to make all connections.

## 2.2 LAN and USB Ports (LAN1/2, USB0102/USB0304/USB0506/USB0708)

AIMB-215 B1 provides up to seven USB 2.0 and one USB 3.0 ports. One USB 3.0 and three USB 2.0 are located on the rear side. The USB interface complies with the USB specification revision 2.0 that supports transmission rates of up to 480 Mbps, and revision 3.0 that supports transmission rates of up to 5 Gbps, and is also fuse protected. Furthermore, the USB interface can be disabled in the system BIOS setup menu.

The AIMB-215 B1 system is equipped with two high-performance 1000 Mbps Ethernet LAN adapters, both of which are supported by all major network operating systems. The RJ-45 jacks on the rear panel facilitate convenient LAN connection.

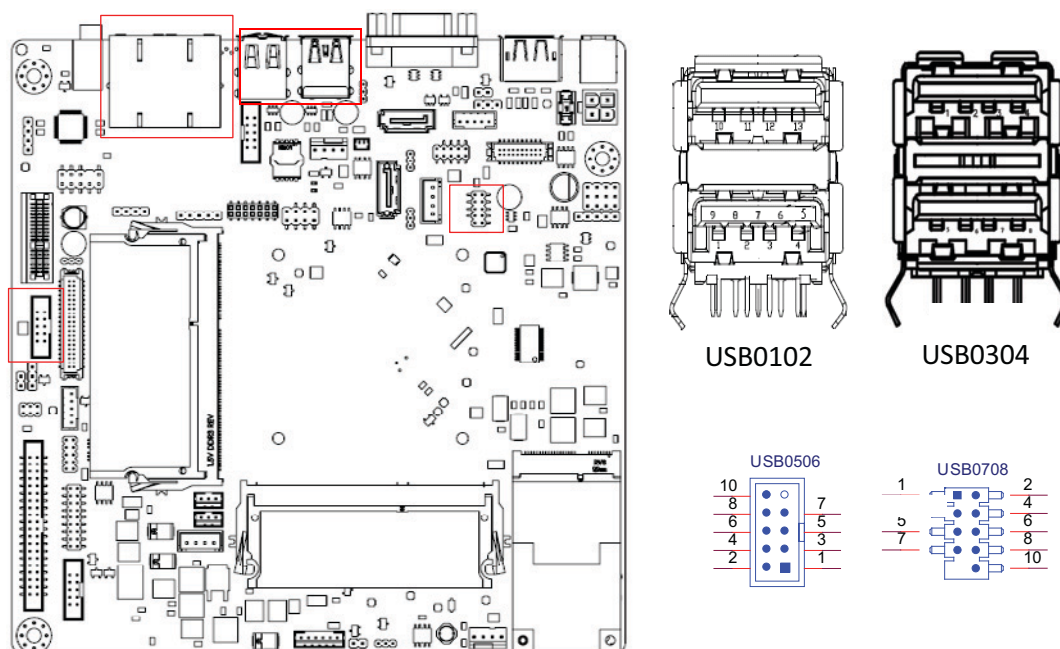

**Table 2.1: LAN LED Indicators**

LAN Mode	LAN Indicator
1 Gbps link on	LED1 Green on
100 Mbps link on	LED1 Orange on
Active	LED2 Green flashing

**Note!** If Windows 7 is selected as the OS, users must install a USB 3.0 XHCI driver.



Please refer to Chapter 8 for information on XHCI driver installation.

## 2.3 VGA Connector (VGA1)

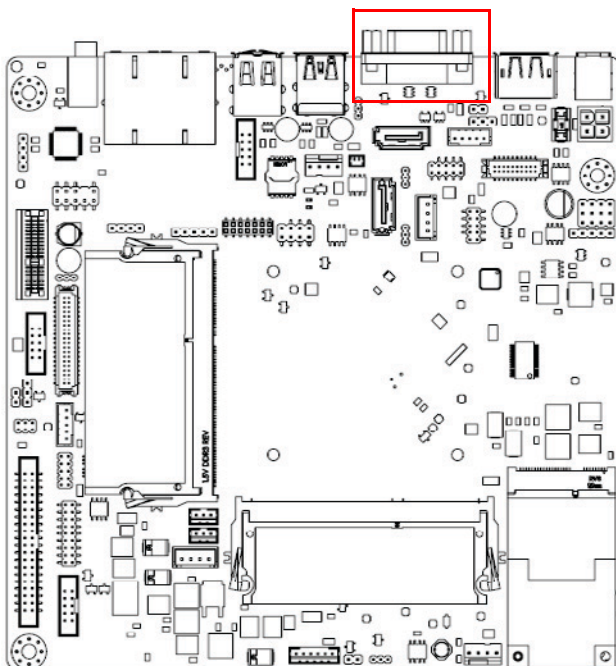

VGA1 is a standard 15-pin D-SUB connector commonly used for VGA. The pin assignments for VGA are detailed in Appendix B.

## 2.4 Serial Ports (COM1 ~ COM6)

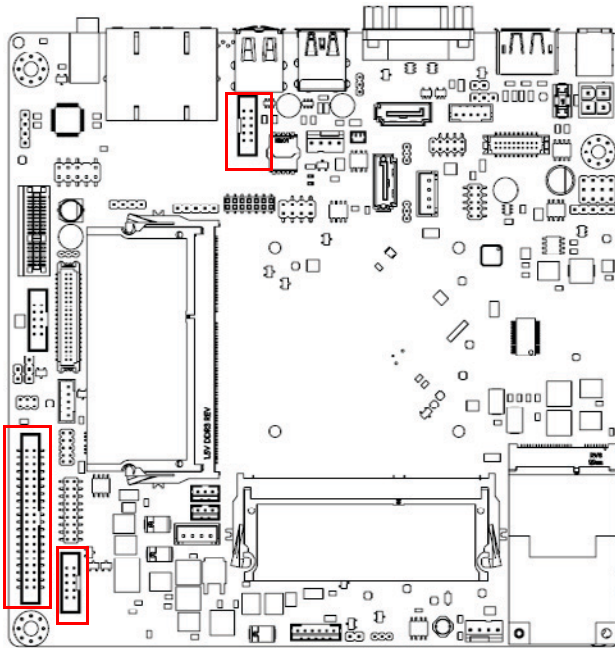

AIMB-215 B1 supports six serial ports. COM3 is RS-232/422/485 and COM1/2/4/5/6 are RS-232. COM6 also supports 5 V/12 V according to jumper selection. Users can employ JSETCOM3 to select between the RS-232/422/485 modes for COM3. Such ports can be connected to serial devices, such as a mouse or printer, or to a communications network.

The IRQ and address ranges for both ports are fixed. However, users can disable the port or change the parameters via the system BIOS setup.

Various devices implement the RS-232/422/485 standards in different manners. Users who experience problems with a serial device are advised check the connector pin assignments.

## 2.5 PS/2 Keyboard and Mouse Connector (KBMS1)

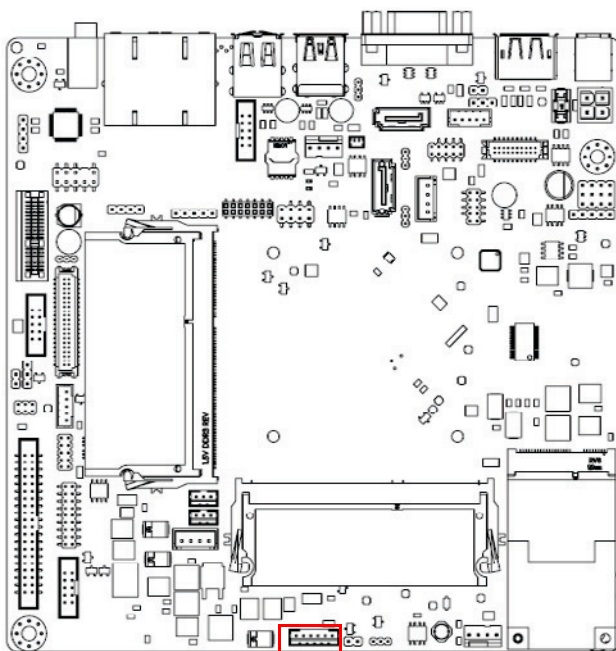

Onboard six-pin wafer box connector, which supports one standard PS/2 keyboard and one standard PS/2 mouse.

## 2.6 Display Port Connector (DP1)

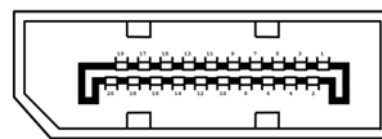
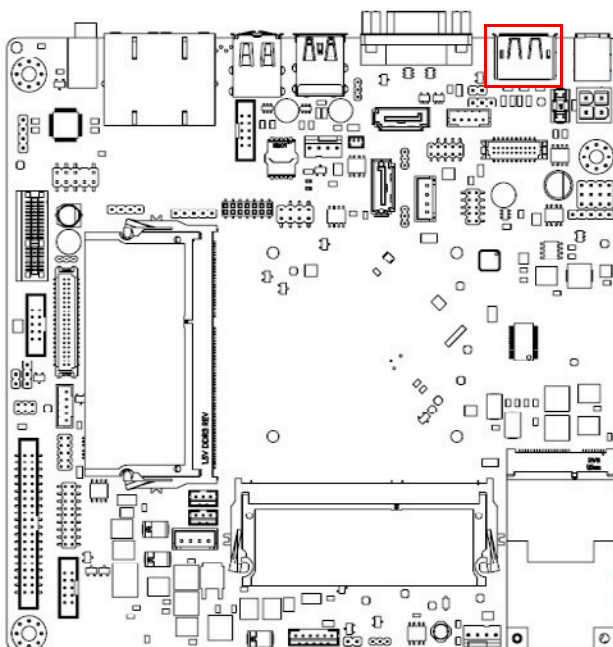

DP1

## 2.7 System FAN Connector (SYSFAN1/2)

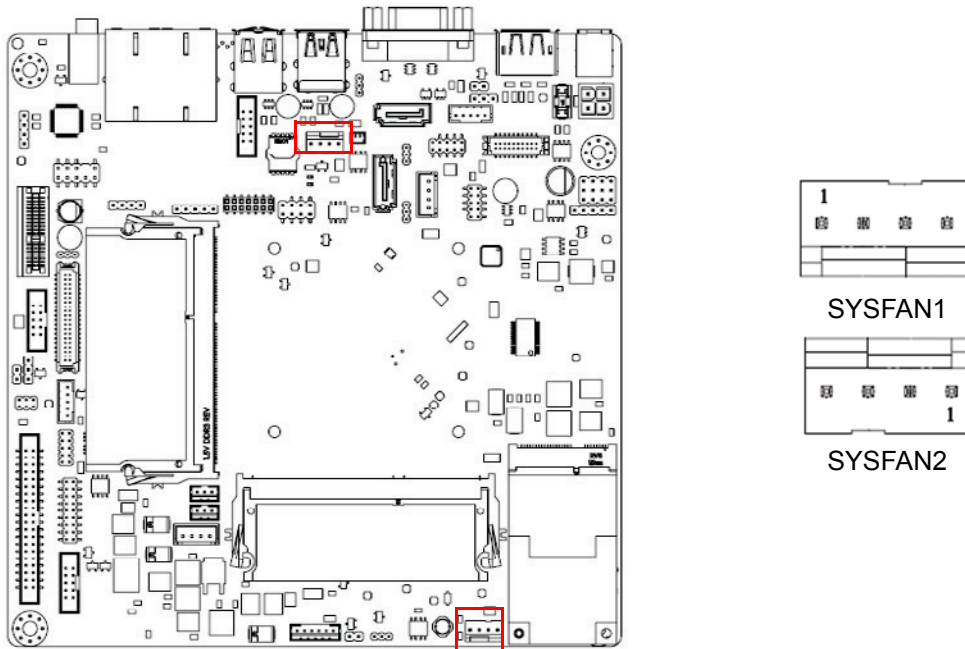

For devices with a fan installed, this connector supports cooling fans of up to 500 mA (6 W).

## 2.8 Front Panel Connectors (JFP3/JFP1 + JFP2)

Several external switches are provided for monitoring and controlling the AIMB-215 B1.

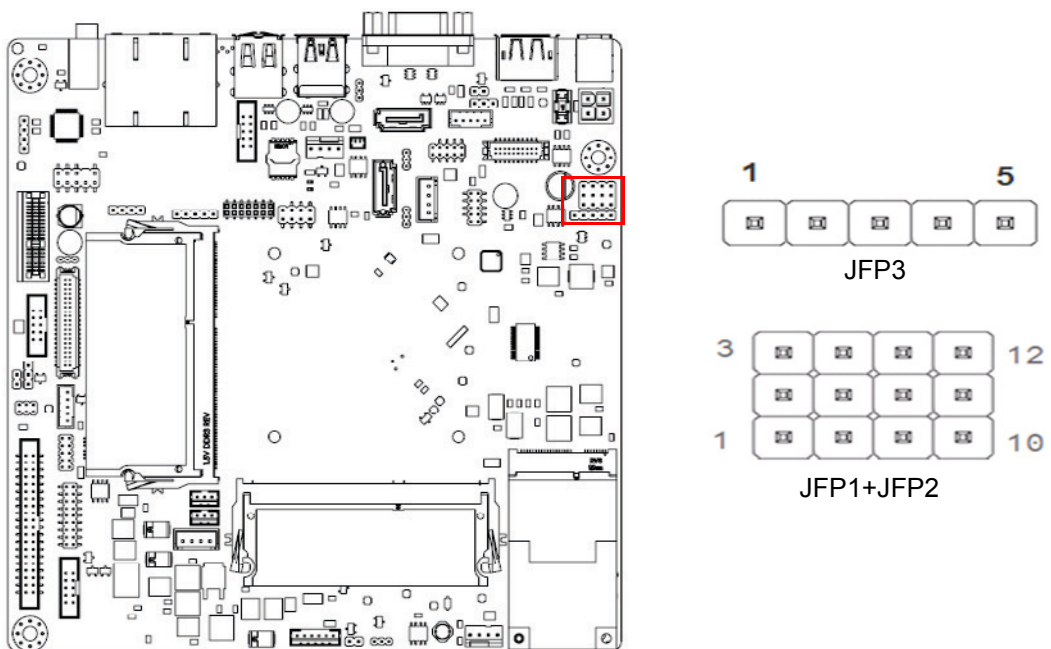



### 2.8.1 ATX Soft Power Switch (JFP1 + JFP2/PWR\_SW)

For computer cases equipped with ATX power supply, users should connect the Power On/Off button on the computer case to (JFP1 + JFP2/PWR\_SW) for convenient Power On/Off functionality.

### 2.8.2 Reset (JFP1 + JFP2/RESET)

Many computer cases offer the convenience of a specific reset button. Connect the wire for the reset button.

### 2.8.3 HDD LED (JFP1 + JFP2/HDDLED)

An LED can be linked to the connector (JFP2/HDDLED) to indicate when the HDD is active.

### 2.8.4 External Speaker (JFP1 + JFP2/SPEAKER)

(JFP1 + JFP2/SPEAKER) is a four-pin connector for an external speaker. If no external speaker is available, the AIMB-215 B1 provides an onboard buzzer as an alternative. To enable the buzzer, set Pins 7-10 as closed.

### 2.8.5 Power LED and Keyboard Lock Connector (JFP3/PWR\_LED and KEY LOCK)

(JFP3/PWR\_LED and KEY LOCK) is a five-pin connector for the Power-On LED and Key Lock function. Refer to Appendix B for detailed information regarding the pin assignments. The Power LED cable should be connected to Pins 1-3. The key lock button cable should be connected to Pins 4 and 5.

Three power supply connection modes exist. The first is the ATX power mode, where the system is powered on/off by momentarily pressing the power button. The second is the AT power mode, where the system is powered on/off using the power supply switch. The third is another AT power mode that involves the front panel power switch. The status differences indicated by the power LED are listed in the following table:

**Table 2.2: ATX Power Supply LED Status (AT power not supported)**

Power mode	LED (ATX power mode) (On/off by momentarily pressing the power button)	LED (AT power mode) (Powered on/off using the power supply switch)	LED (AT power mode) (Powered on/off using the front panel switch)
PSON1 (on the back plane) jumper setting	Pins 2-3 closed	Pins 1-2 closed	Connect Pins 1 and 2 to the panel switch using a cable
System On	On	On	On
System Suspend	Fast flashing	Fast flashing	Fast flashing
System Off	Slow flashing	Off	Off

## 2.9 Line-Out Connector (AUDIO1)

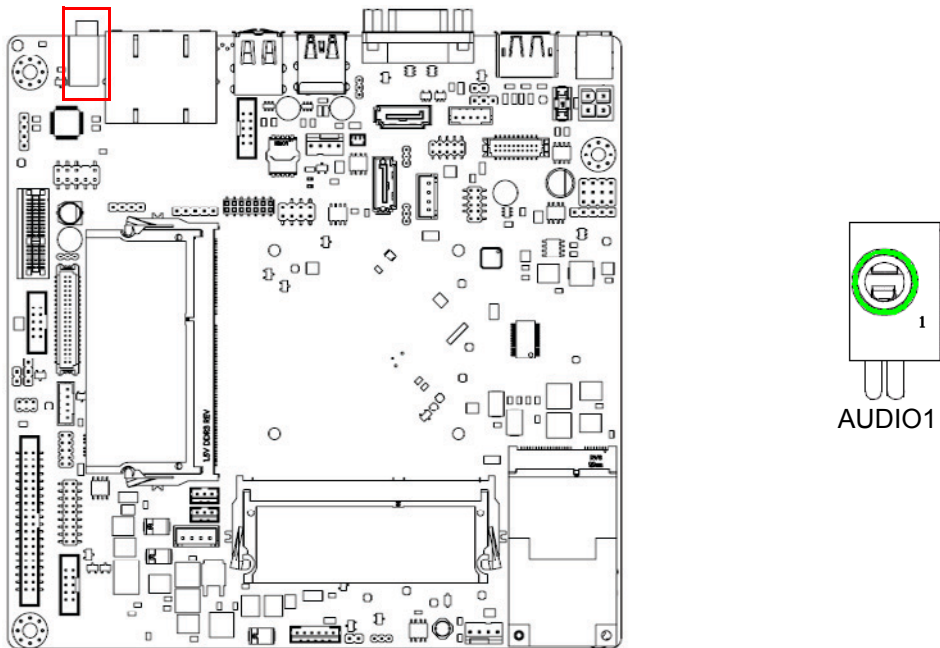

This connector supports line-out, mic-in, and line-in functions.

## 2.10 Serial ATA Interface (SATA1/2) & SATADOM Power Pin Header (JSATAPWR1)

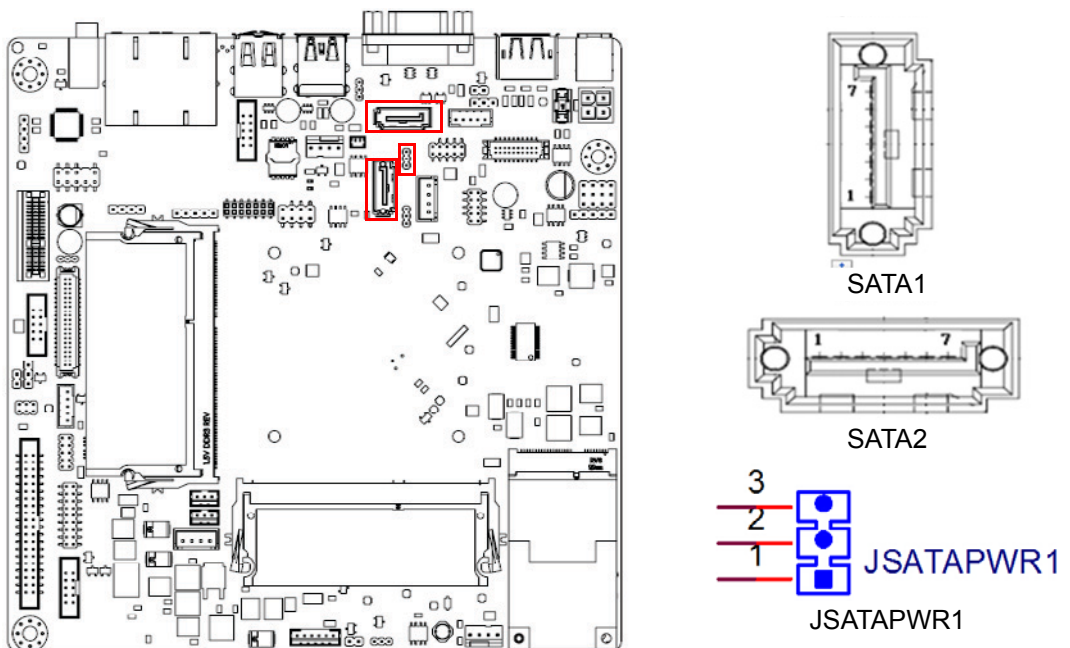

AIMB-215 B1 features a high-performance Serial ATA interface (up to 300 MB/s) that allows cabling to hard drives using long, thin cables.

**Note!** *SATA2 is only supported when mSATA is not in use. SATA2 and mSATA cannot be used concurrently.*



**Table 2.3: SATADOM Power Pin Header (JSATAPWR1)**

Pin	Signal
1	GND
2	SATA_DOM
3	+V5

## 2.11 PCI-Express x1 Slot (PCIEX1\_1)

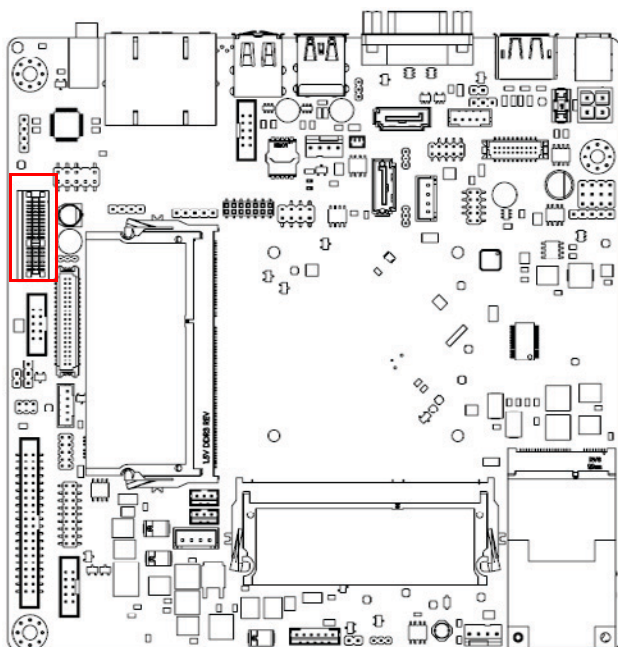

The AIMB-215 B1 features one PCIe x1 slot.

## 2.12 Front Panel Audio Connector (FPAUDIO1)

This connector is for a chassis-mounted front-panel audio I/O module that supports either HD audio or a legacy AC'97 (optional) standard. This connector is attached using the front panel audio I/O module cable.

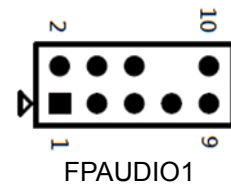
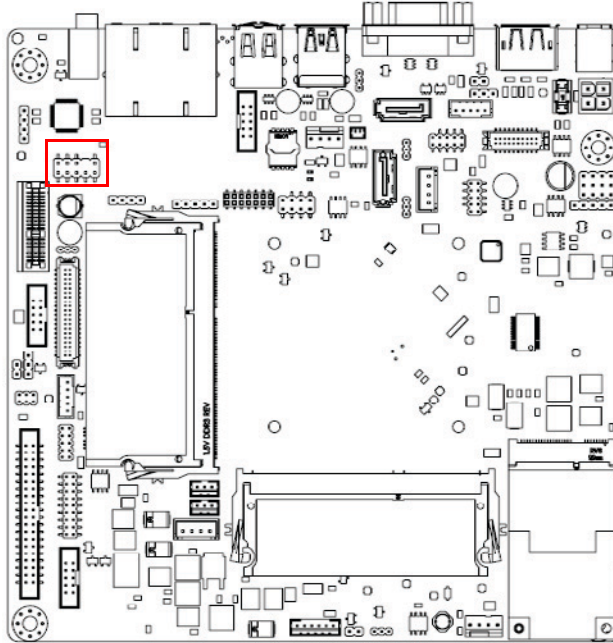

## 2.13 ATX 12V Power Connector (ATX12V1)

This connector is for an ATX Micro-Fit power supply. The plugs from the power supply are designed to fit these connectors in only one direction. Determine the correct orientation and press firmly until the connectors mate completely.

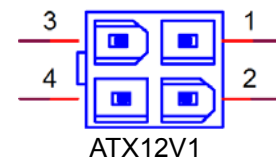
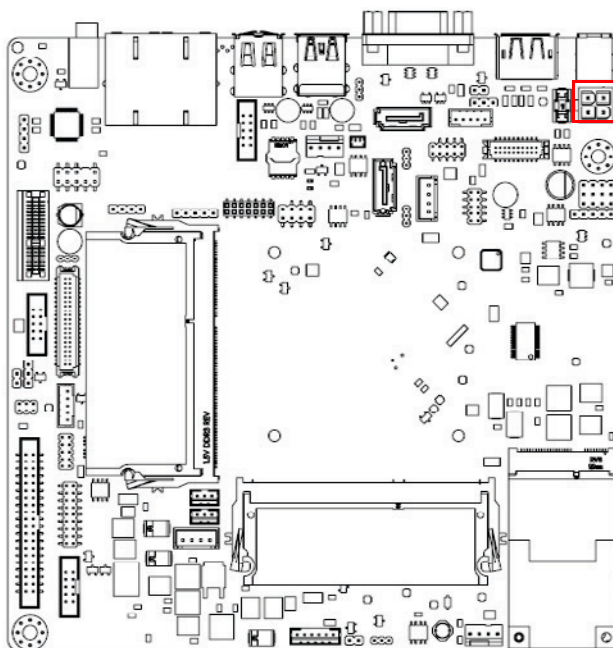

## 2.14 SPI Flash Connector(SPI\_CN1)

The SPI flash card pin header may be used to flash the BIOS if the AIMB-215 B1 cannot be powered on.

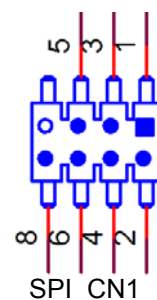
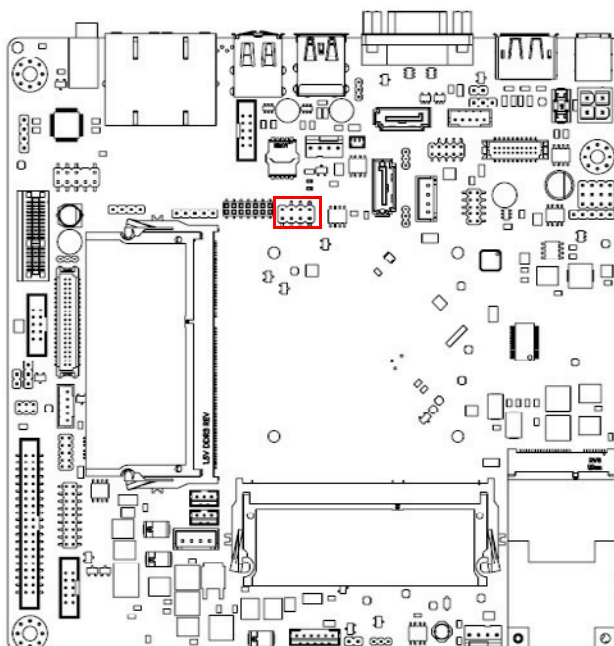

## 2.15 LVDS Backlight Inverter Power Connector (INV1)

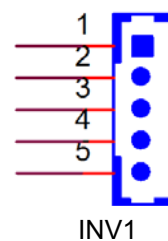
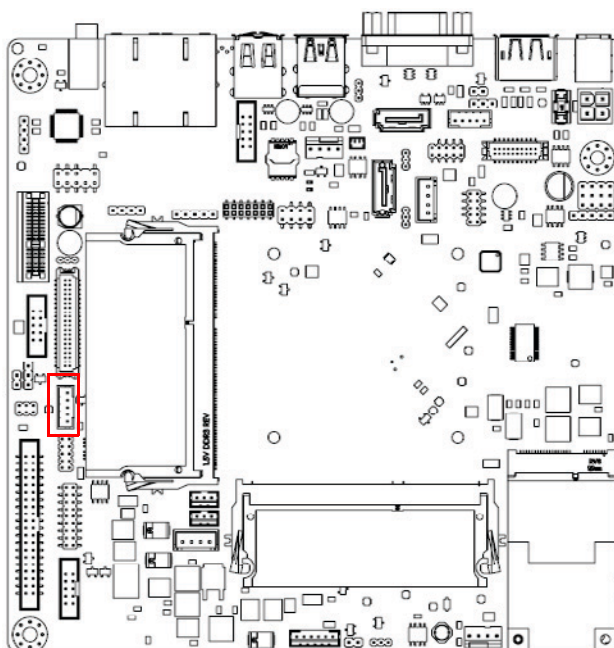



**Note!** ■ **Signal Description**



**Signal**

VR

ENBKL

**Signal Description**

$V_{adj}=0.75\text{ V}$

(Recommended:  $4.7\text{ K}\Omega$ ,  $>1/16\text{ W}$ )

LCD backlight ON/OFF control signal

## 2.16 LVDS Connector (LVDS1)

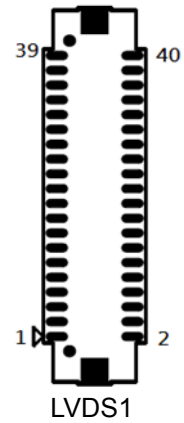
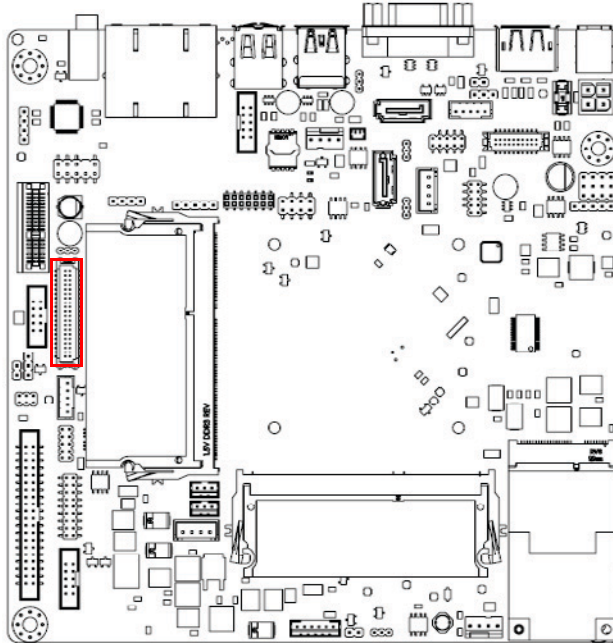

Pin 3: GND → Panel connected  
NC/3.3 V → No panel

## 2.17 General Purpose I/O Connector (GPIO1)

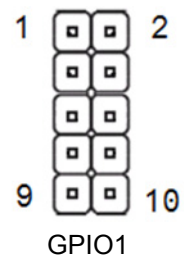
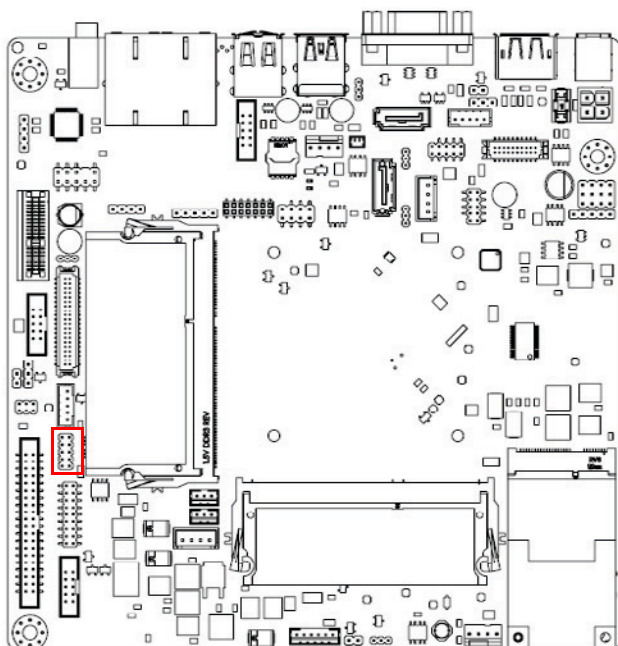

## 2.18 CMOS Battery Wafer Box (BAT1)

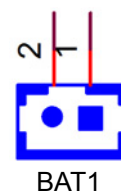
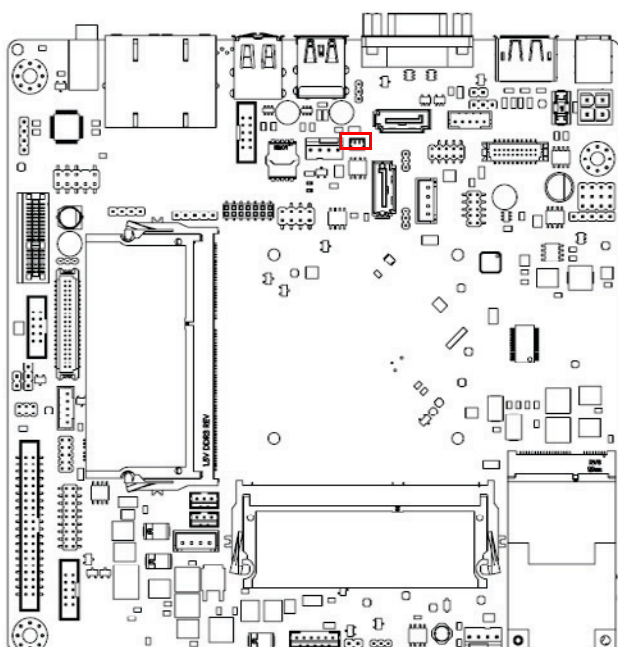

## 2.19 SPI BIOS Socket (SPI1)

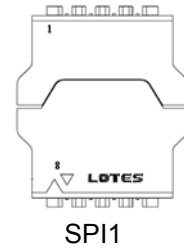
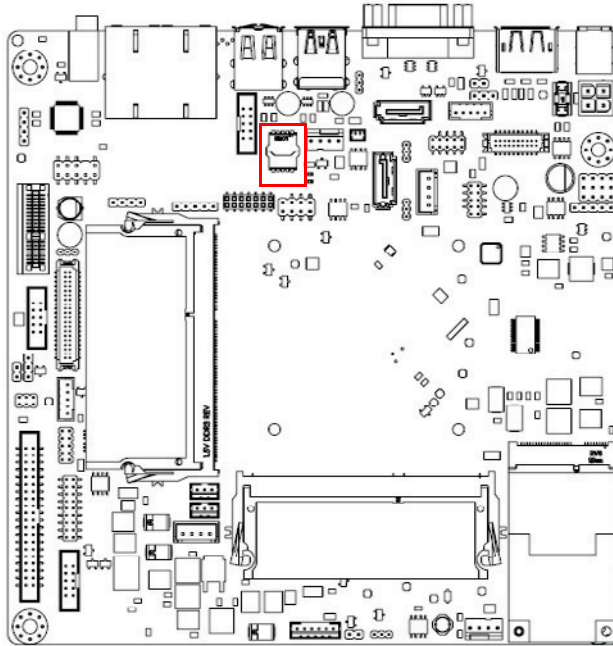

## 2.20 SPDIF Interface Pin Header (SPDIF\_OUT1)

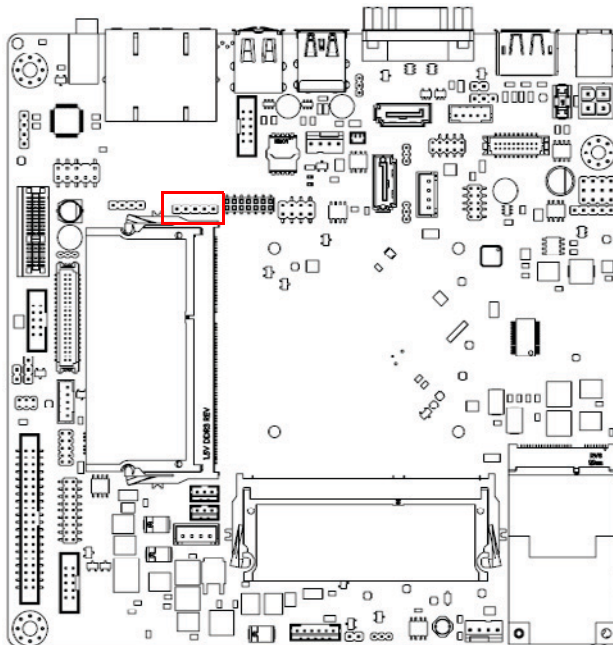



## 2.21 Audio Amplifier Output Pin Header (JAMP1) (BOM Optional)

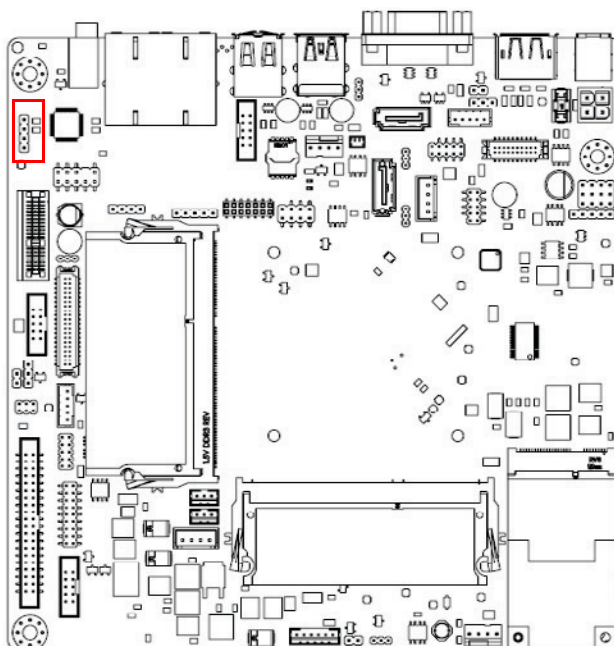

## 2.22 ATX Power Supply (5VSB) Connector (ATX\_5VSB1)

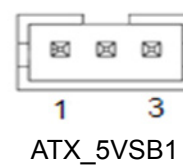
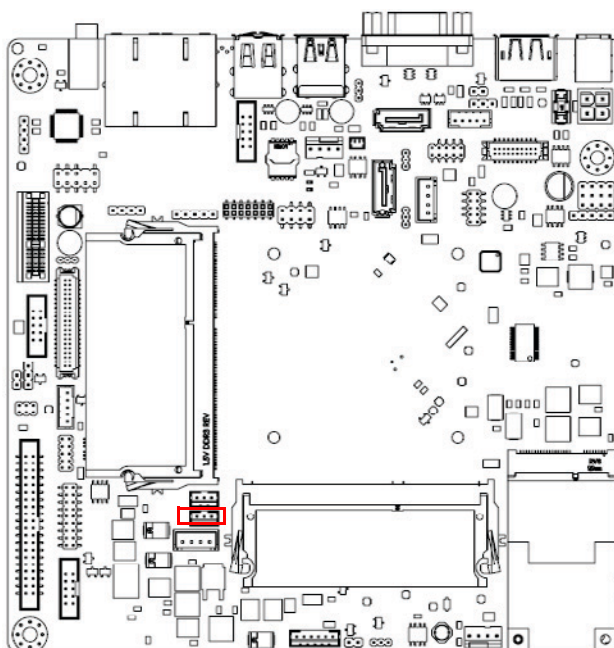

## 2.23 SATA Power Connector (SATA\_PWR1/2)

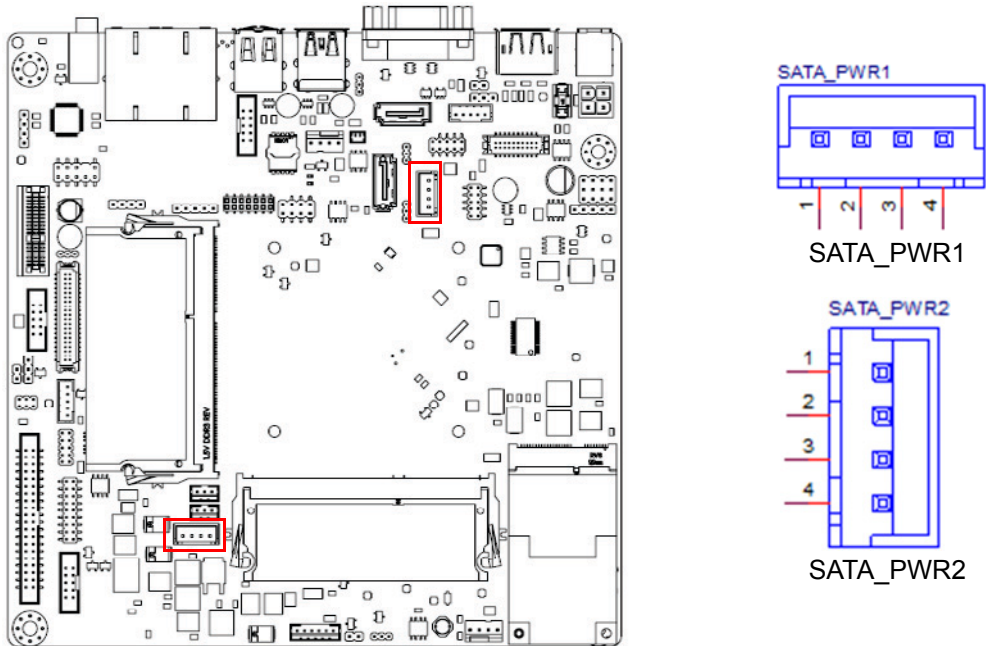

## 2.24 Case Open Pin Header (JCASE1)

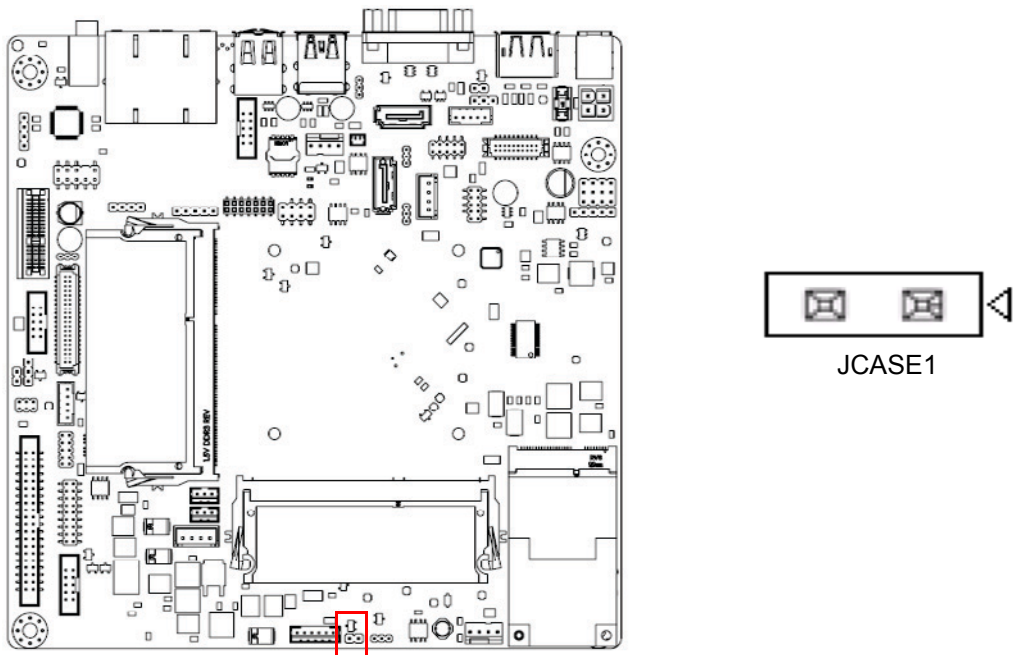

## 2.25 DDR3L SODIMM Socket (DIMMA1/B1)

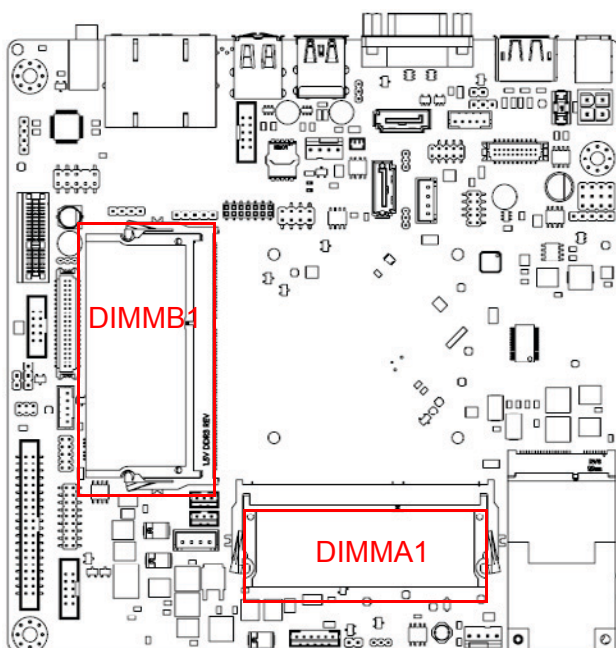

**Note!** AIMB-215 B1 supports 1.35 V memory only. Users must populate the memory on socket DIMMA1 first.



Users are advised to use memory modules of the same type, speed, and frequency for each motherboard. Memory modules of different types and speeds should not be used.

## 2.26 Mini-PCle and mSATA Connector (MINIPCI1)

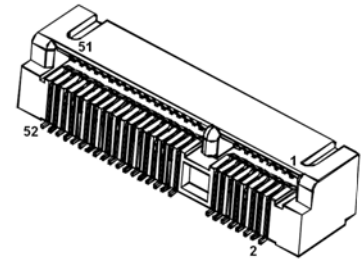
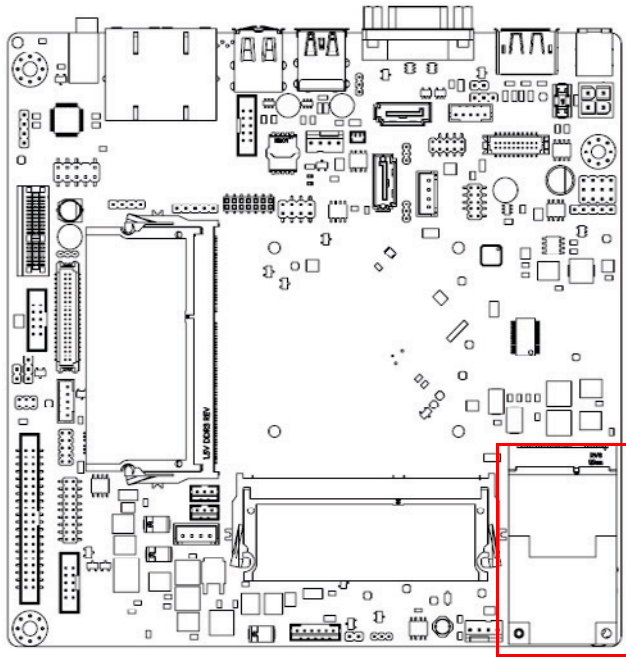

MINIPCI1

## 2.27 Mini-PCle Connector (MINIPCI2)

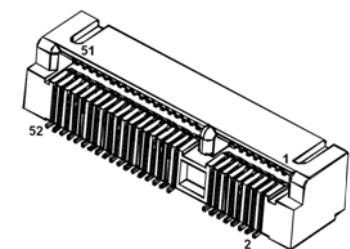
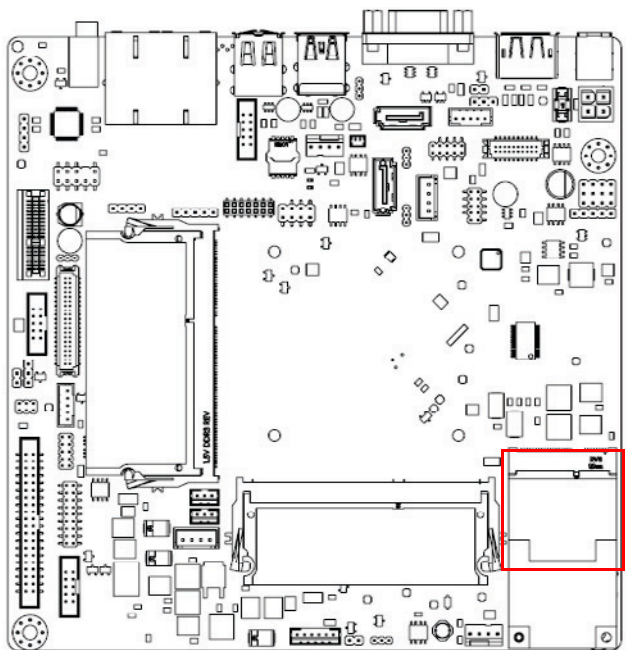

MINIPCI2

## 2.28 Low Pin Count Interface Header (LPC1)

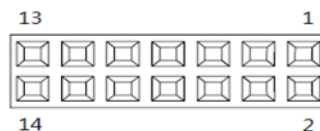
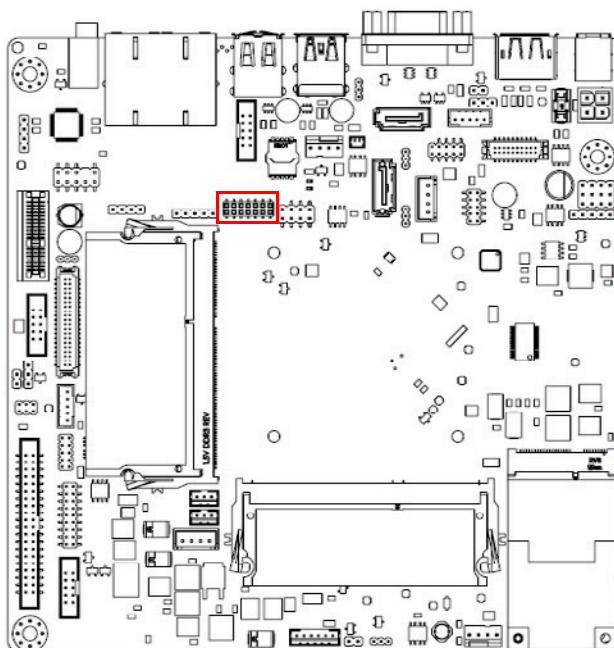

## 2.29 RTC Reset Pin Header (JRTCTEST1)

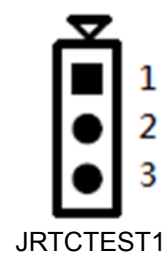
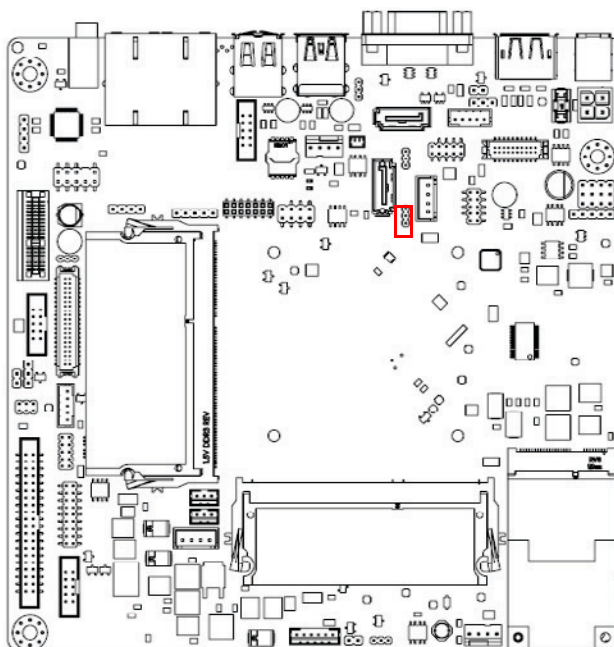



## 2.30 eDP Connector (eDP1) (BOM Optional)

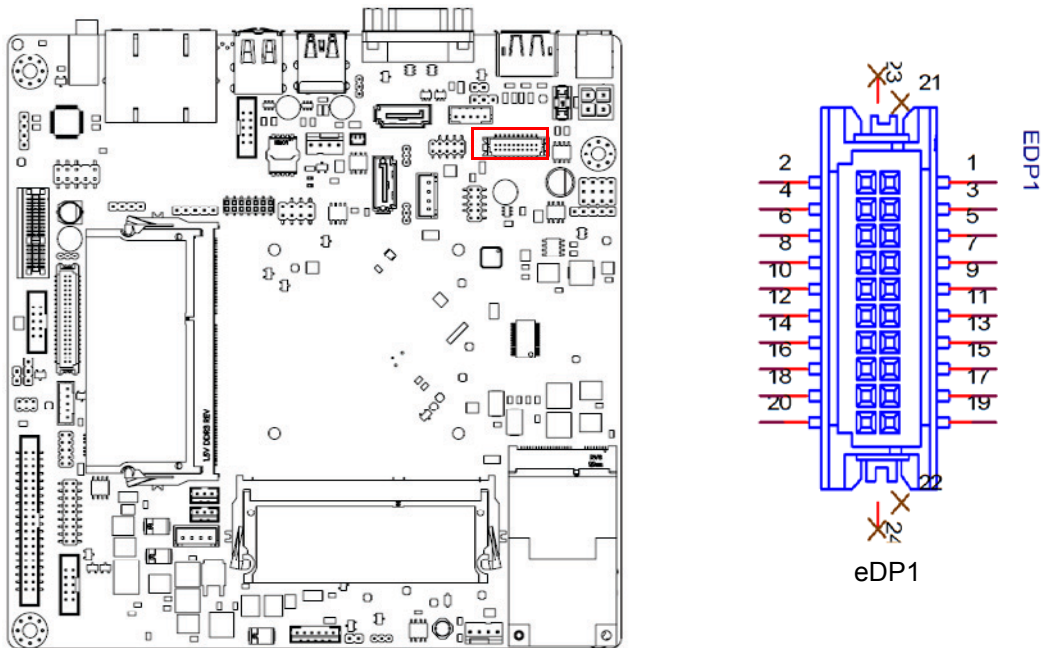

## 2.31 eDP Backlight Inverter Power Connector (INV-EDP1) (BOM Optional)

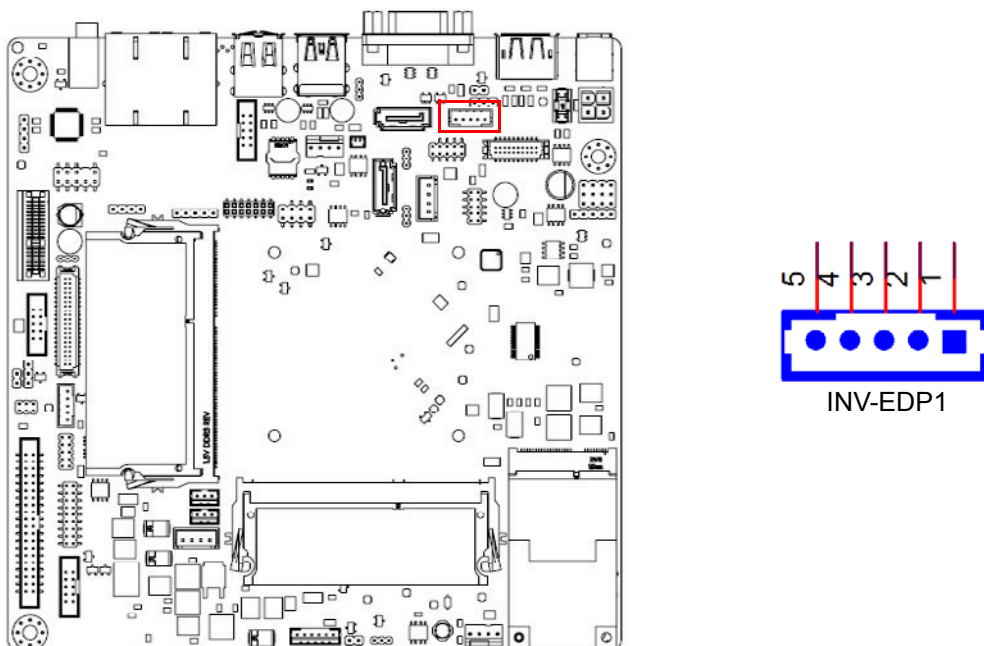

## 2.32 SIM Card Holder (SIM2)

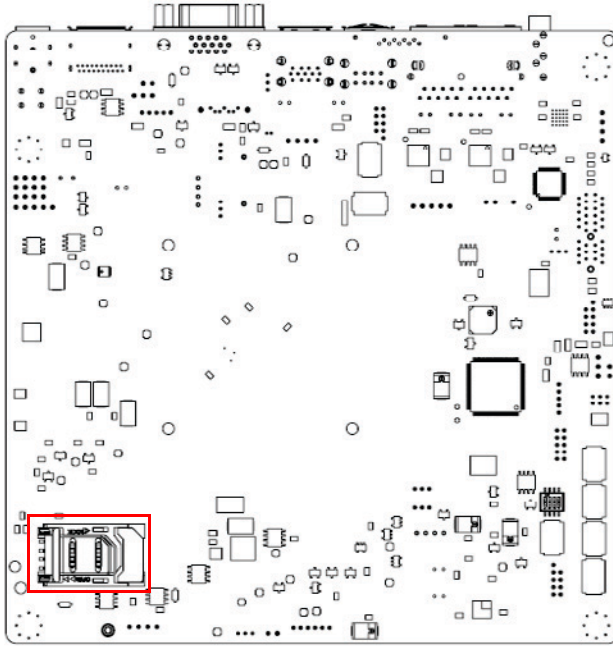

SIM2





# Chapter 3

BIOS Operation

## 3.1 Introduction

AMI BIOS has been integrated into numerous motherboards for over a decade. The AMI BIOS setup menu may also be referred to as the BIOS, BIOS setup, or CMOS setup. With the AMI BIOS Setup program, users can modify the BIOS settings and control the special system features. The Setup program comprises several menus with options for adjusting or turning special features on or off. This chapter describes the basic navigation of the AIMB-215 B1 BIOS setup menu pages.

## 3.2 BIOS Setup

The AIMB-215 B1 Series is equipped with built-in AMI BIOS and a CMOS Setup Utility that allows users to configure specific settings or activate certain system features. The CMOS Setup Utility saves the configuration in the CMOS RAM of the motherboard. When the system power is turned off, the battery on the board supplies the necessary power to preserve the CMOS RAM.

When the power is turned on, press the <Del> button during the BIOS power-on self-test (POST) to access the CMOS Setup Utility screen.

---

### Control Keys

< ↑ >> ↓ >> ← >> → >	Move select item
<Enter>	Select item
<Esc>	Main Menu - Quit without saving changes to the CMOS Sub Menu - Exit current page and return to the Main Menu
<Page Up/+>	Increase the numeric value or make changes
<Page Down/->	Decrease the numeric value or make changes
<F1>	General help, for Setup Sub Menu
<F2>	Item help
<F5>	Load previous values
<F7>	Load setup defaults
<F10>	Save all CMOS changes

### 3.2.1 Main Menu

Press <Del> to enter the AMI BIOS CMOS Setup Utility, the Main Menu will appear on the screen. Use the arrow keys to select items and press <Enter> to access the submenu.

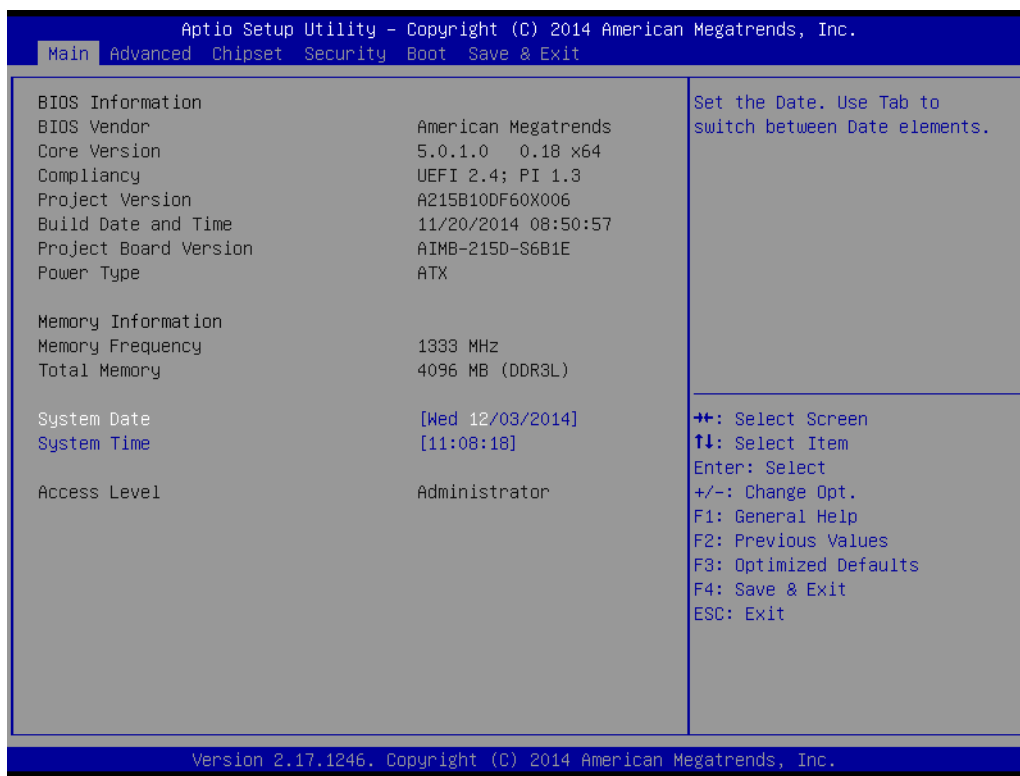

The Main BIOS Setup page comprises two main frames. The left frame displays all configurable options. Grayed-out options cannot be configured, whereas the options displayed in blue can be. The right frame also displays the key legend.

The area above the key legend is reserved for text messages. When an option is selected in the left frame, the display text changes to white and is often accompanied by a text message.

#### ■ System Time/System Date

Use this option to change the system time and date. Highlight the System Time or System Date using the <Arrow> keys. Enter new values via the keyboard. Press the <Tab> or <Arrow> keys to move between fields. The date must be entered in MM/DD/YY format. The time must be entered in HH:MM:SS format.

### 3.2.2 Advanced BIOS Features

Select the Advanced tab from the AIMB-215 B1 Setup menu to enter the Advanced BIOS Setup page. Users can select any item in the left frame of the screen, such as CPU Configuration, to access the submenu for that item. Select an Advanced BIOS Setup option by highlighting the text using the <Arrow> keys. All Advanced BIOS Setup options are described in this section. The Advanced BIOS Setup menu screen is shown below. The submenus are described in the following pages.

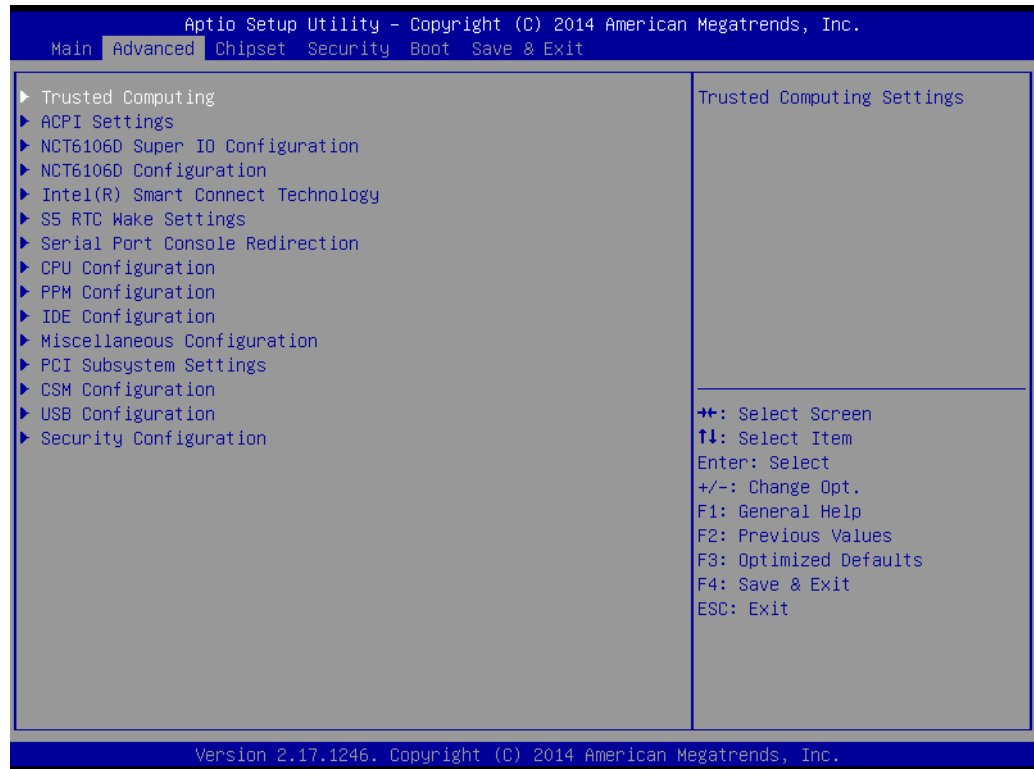

### 3.2.2.1 Trusted Computing (BOM Optional)



- **Security Device Support**  
To enable or disable BIOS support for security device
- **TPM State**  
To enable or disable security device.
- **Pending operation**  
Schedule an Operation for the Security Device.
- **TPM Enabled Status**  
Provides the current capability state of the security device.
- **TPM Active Status**  
Provides the current capability state of the security device.
- **TPM Owner Status**  
Provides current Ownership state. ie: Owned or Unowned.

### 3.2.2.2 ACPI Settings

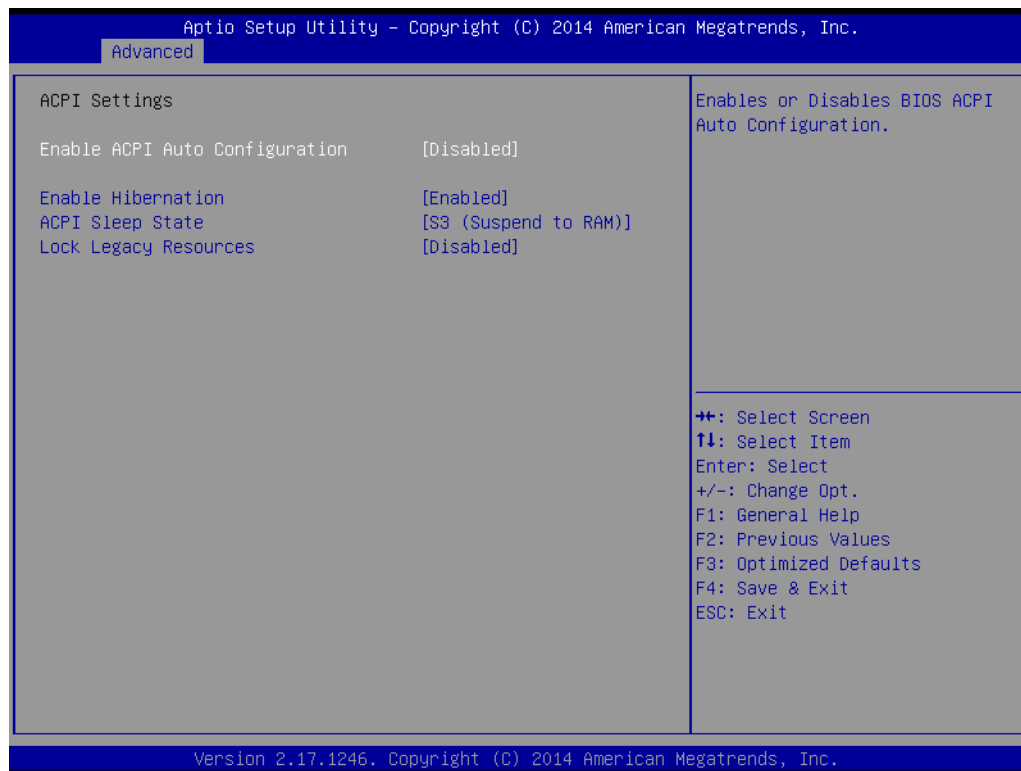

- **Enable ACPI Auto Configuration**  
This item allows users to enable or disable ACPI auto configuration.
- **Enable Hibernation**  
This item allows users to enable or disable hibernation.
- **ACPI Sleep State**  
This item allows users to set the ACPI sleep state.
- **Lock Legacy Resources**  
This item allows users to lock legacy device resources.

### 3.2.2.3 Super IO Configuration

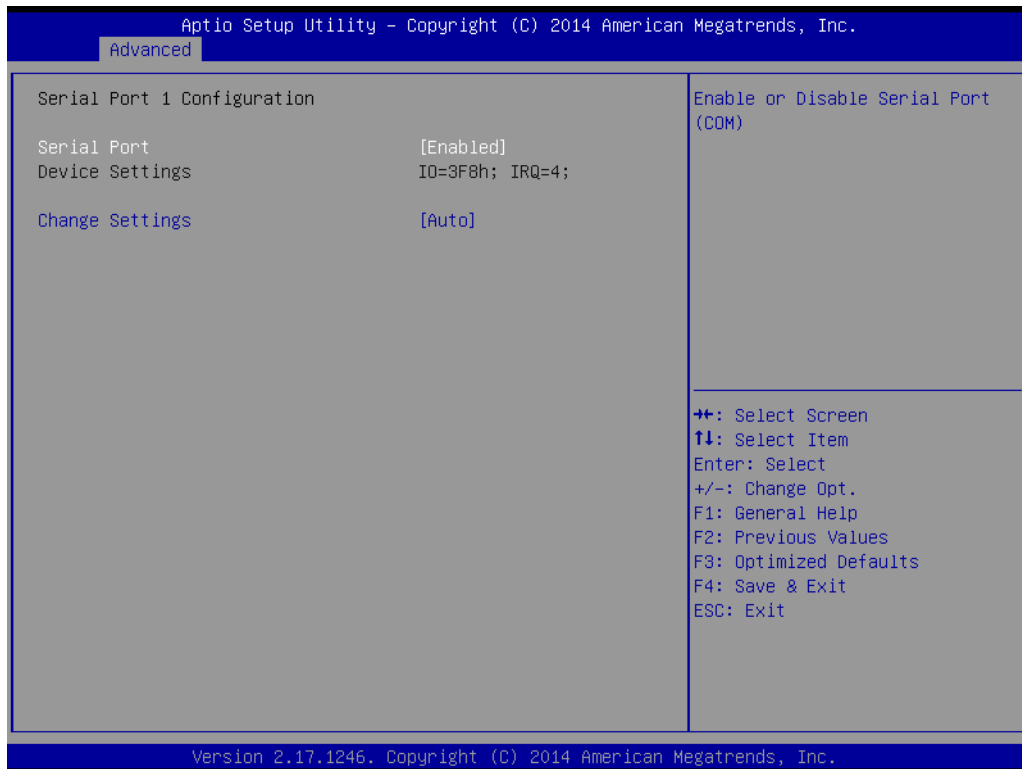
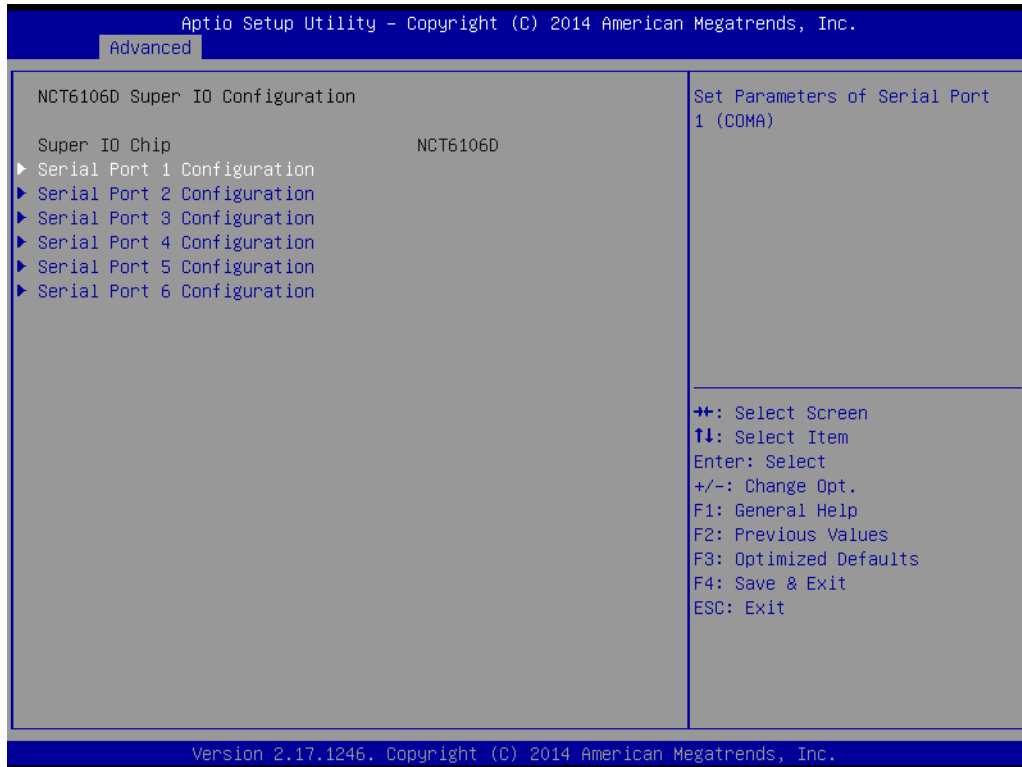

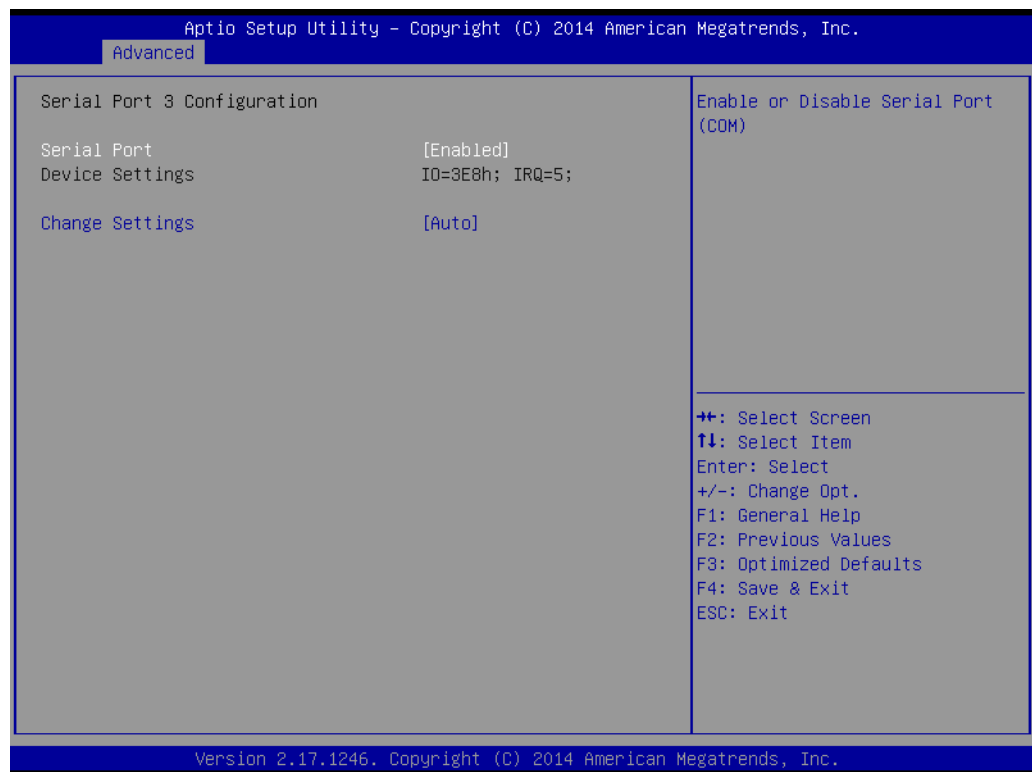



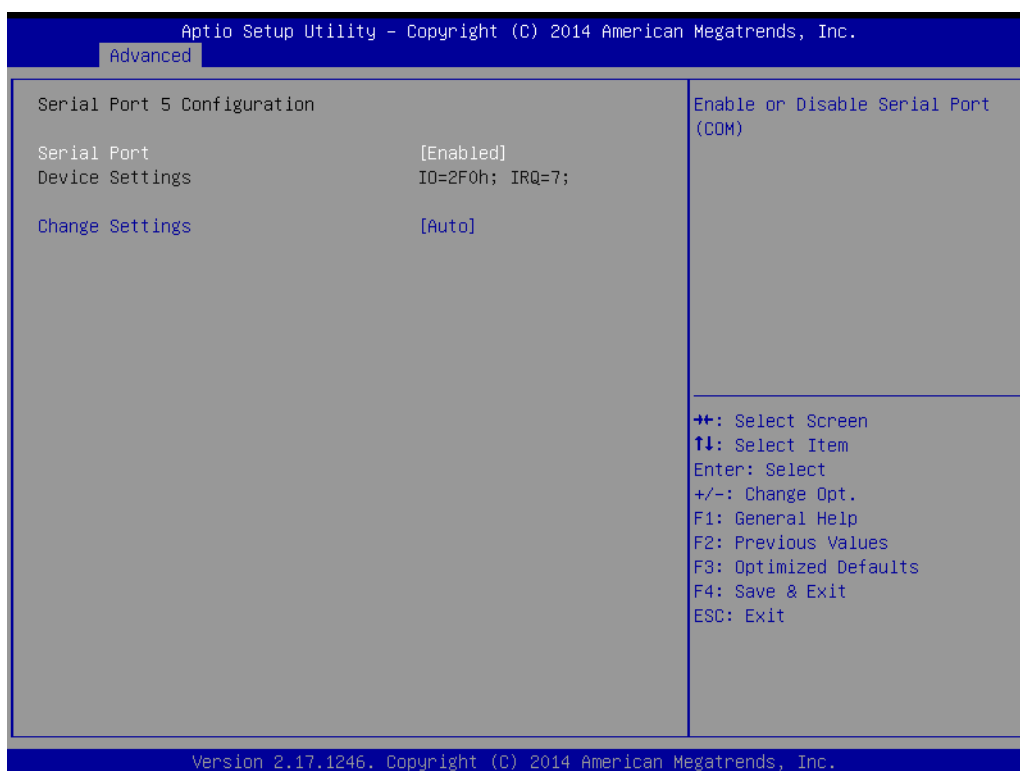
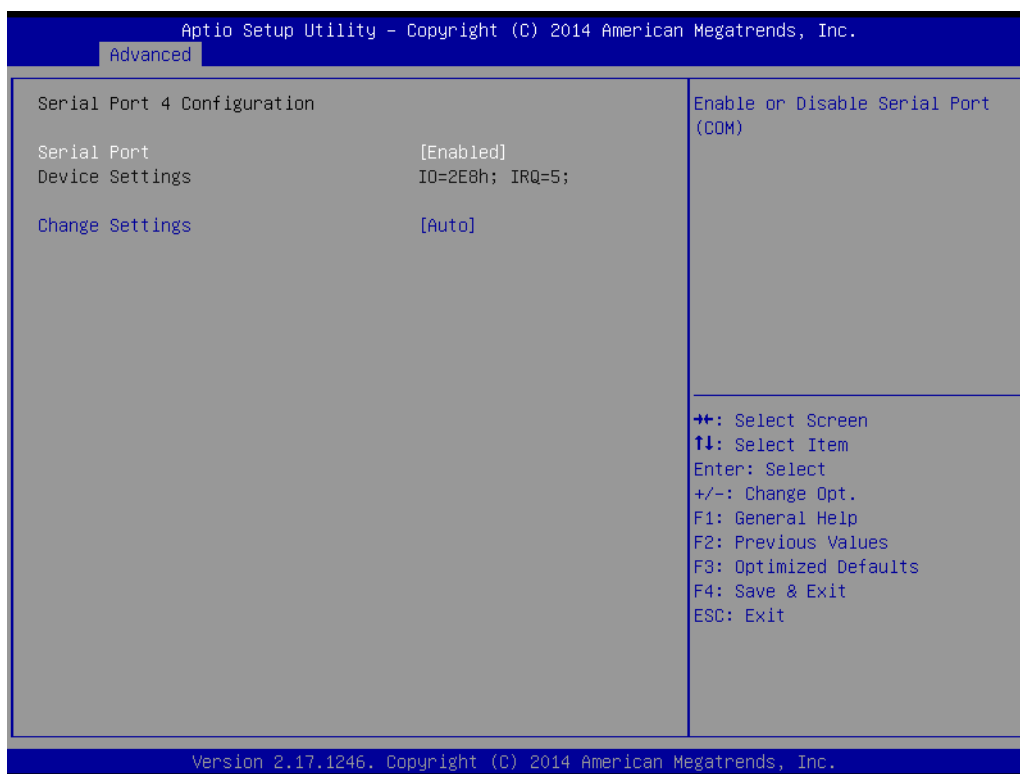



- **Serial Ports 1/2/3/4/5/6**  
This item allows users to enable or disable serial Ports 1/2/3/4/5/6.
- **Change Settings**  
This item allows users to change the settings for serial Ports 1/2/3/4/5/6.

### 3.2.2.4 PC Health Status

This page shows the AIMB-215 B1 PC health status.

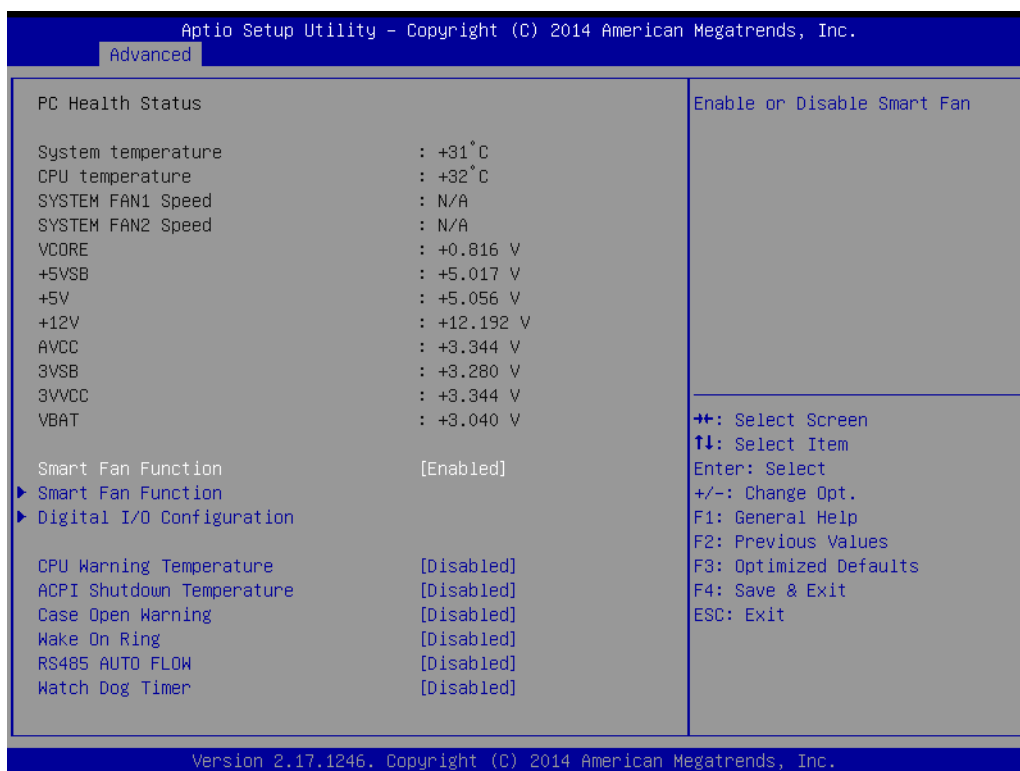

- **Smart Fan Function**  
This item allows users to enable or disable the System Smart Fan function.
- **CPU Warning Temperature**  
This item allows users to set the CPU temperature threshold. When the system CPU reaches the threshold temperature, a buzzer will emit a warning alert.
- **ACPI Shutdown Temperature**  
This item allows users to set the CPU temperature threshold at which the system automatically shuts down to prevent the CPU from overheating.
- **Case Open Warning**  
This item allows users to enable or disable the Case Open Warning function.
- **Wake On Ring**  
This item allows users to enable or disable Wake On Ring functionality.
- **RS-485 AUTO FLOW**  
This item allows users to enable or disable the RS-485 AUTO FLOW function.
- **Watchdog Timer**  
This item allows users to enable or disable the Watchdog timer.

### 3.2.2.5 Smart Fan Mode Configuration

This page shows the Smart Fan Mode items.

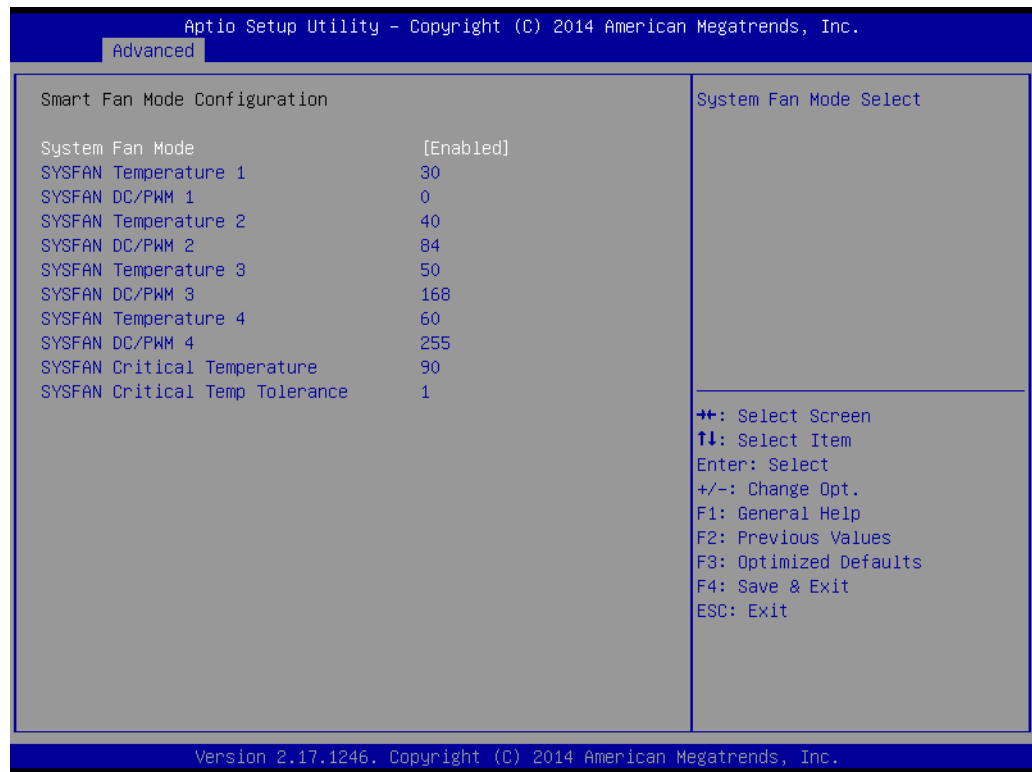

#### ■ Smart Fan Mode

This item allows users to enable or disable Smart Fan mode.

### 3.2.2.6 Digital I/O Configuration

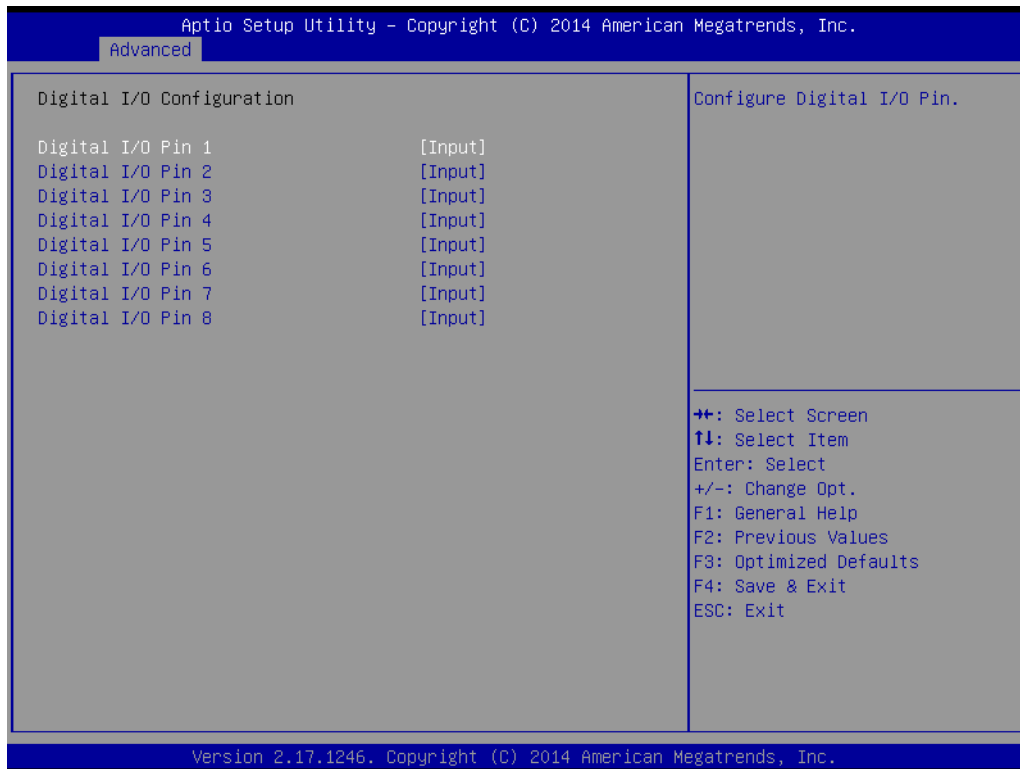

- **Digital I/O Configuration**

This item allows users to set digital I/O 1 to 8 as inputs or outputs.

### 3.2.2.7 ISCT Support



- **ISCT Support**

This item allows users to enable or disable ISCT support.

### 3.2.2.8 S5 RTC Wake Settings

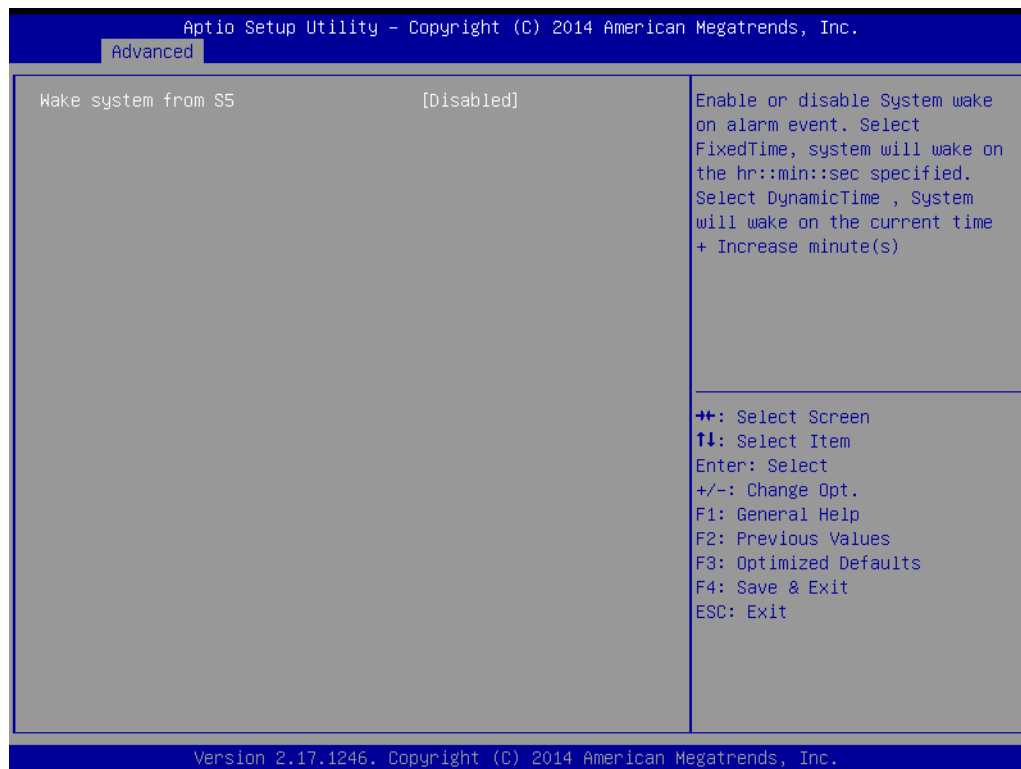

- **Wake System From S5**

This item allows users to enable or disable system wake on alarm event.

### 3.2.2.9 Serial Port Console Redirection

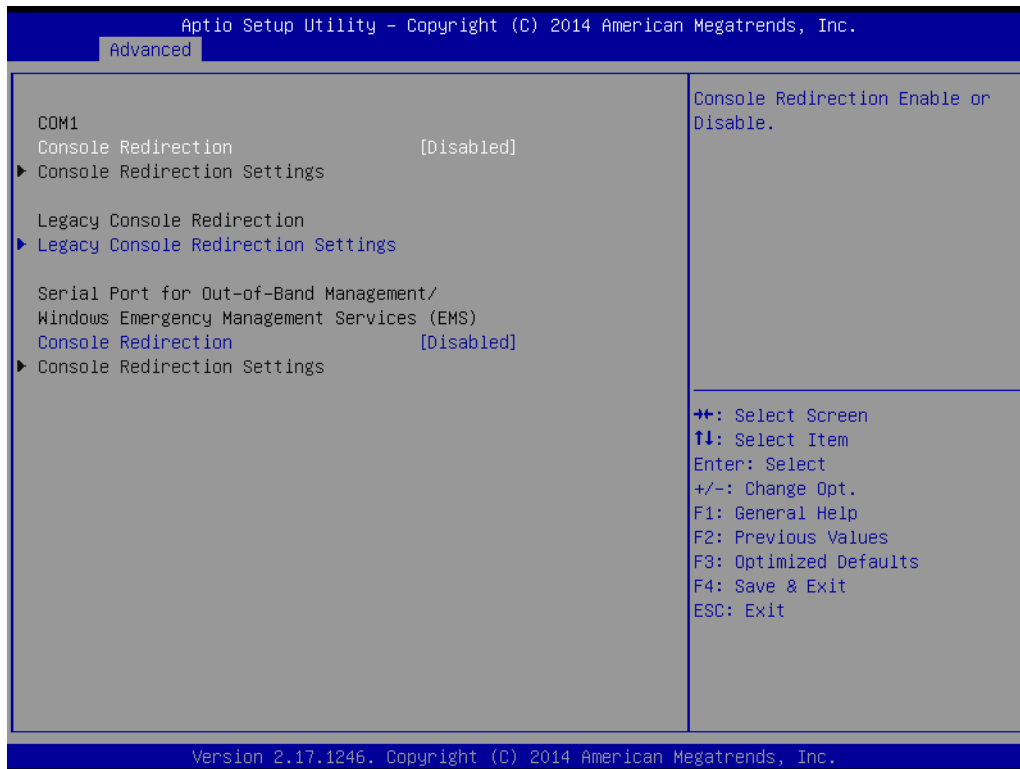

- **Console Redirection**  
This item allows users to enable or disable console redirection.

### 3.2.2.10 CPU Configuration



- **Limit CPUID Maximum**  
This item allows users to enable or disable the ability to limit the CPUID maximum.
- **Execute Disable Bit**  
This item allows users to enable or disable the Execute Disable Bit function.
- **Intel Virtualization Technology**  
This item allows users to enable or disable Intel® Virtualization Technology.
- **Power Technology**  
Enable the power management features.



This page shows the CPU information.

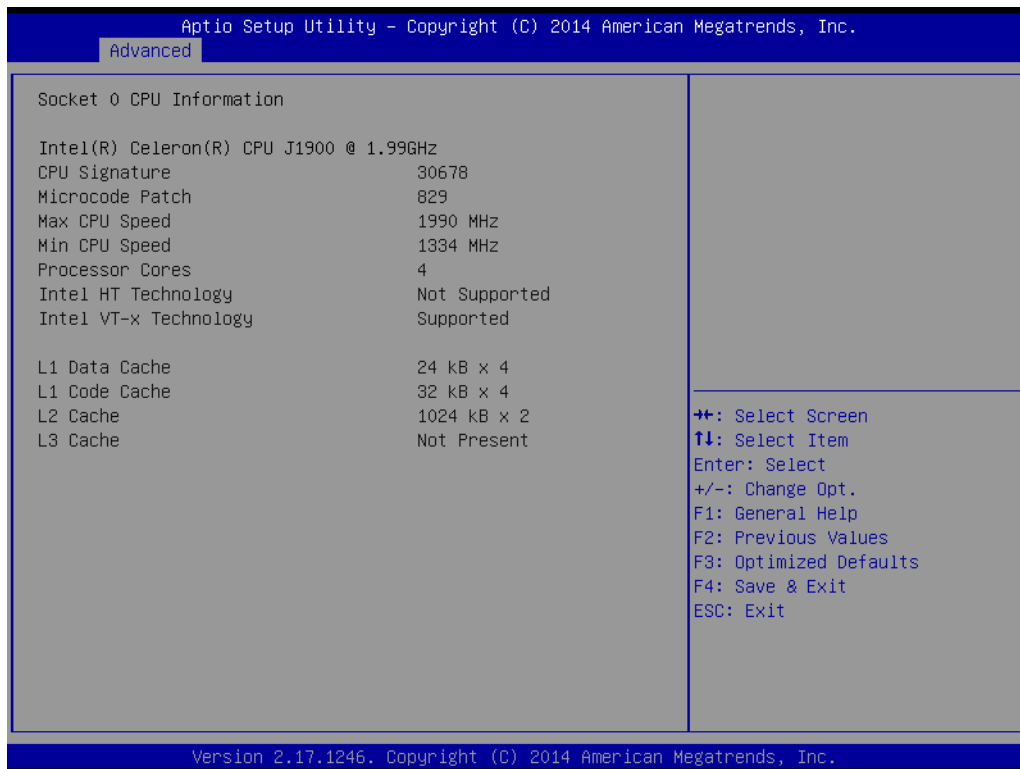

### 3.2.2.11 PPM Configuration

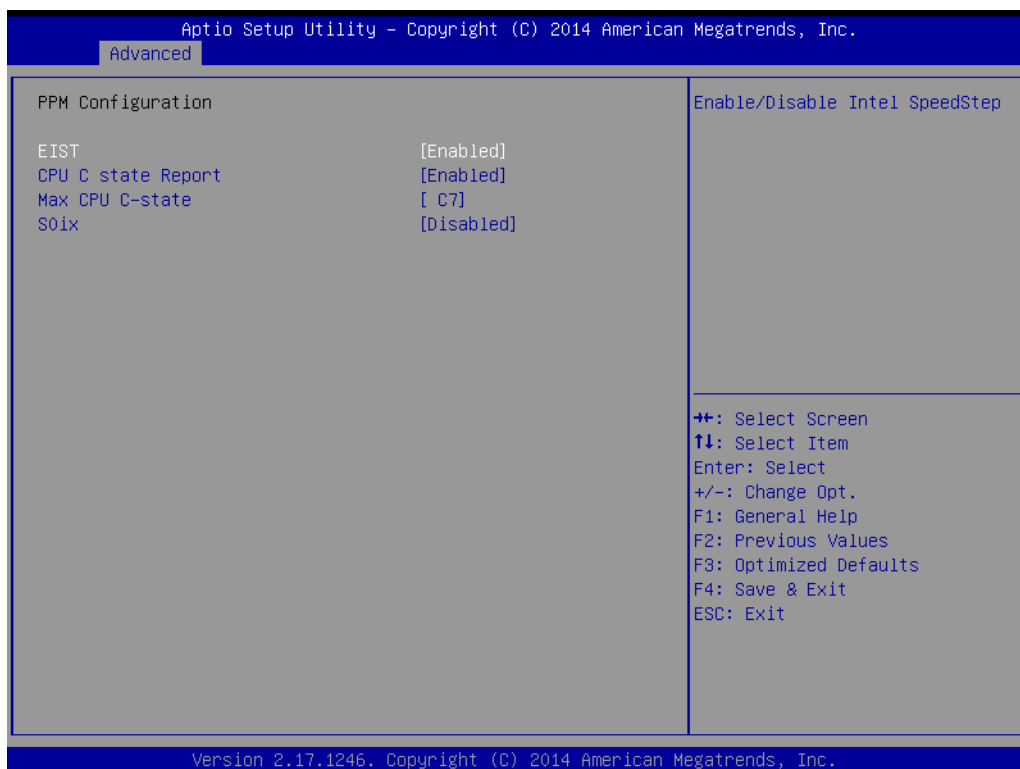

- **EIST**  
To enable or disable Intel SpeedStep.
- **CPU C state Report**  
To enable or disable CPU C state report to OS.

- **Max CPU C-state**  
This option controls Max C state that the processor will support.
- **S0ix**  
This item allows users to enable or disable the CPU S0ix state.

### 3.2.2.12 IDE Configuration

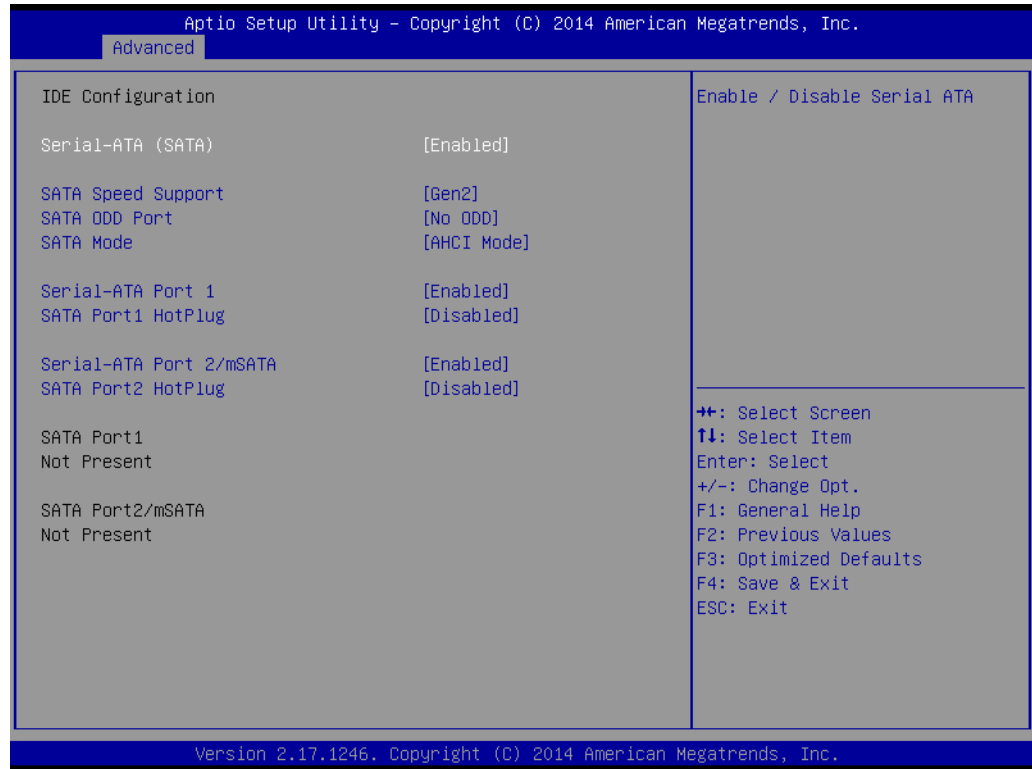

- **Serial-ATA (SATA)**  
This item allows users to enable or disable the SATA device.
- **SATA Speed Support**  
This item allows users to select the SATA speed (Gen1 or Gen2).
- **SATA ODD Port**  
This item allows users to set Port 1 or 2 to have ODD functionality.
- **SATA Mode**  
This item allows users to select the mode for SATA controller(s).
- **Serial-ATA Port 1**  
This item allows users to enable or disable the Serial-ATA Port 1 device.
- **SATA Port 1 Hot Plug**  
This item allows users to enable or disable the SATA Port 1 hot plug.
- **Serial-ATA Port 2**  
This item allows users to enable or disable the Serial-ATA Port 2 / mSATA device.
- **SATA Port 2 Hot Plug**  
This item allows users to enable or disable the SATA Port 2 hot plug.

### 3.2.2.13 Miscellaneous Configuration

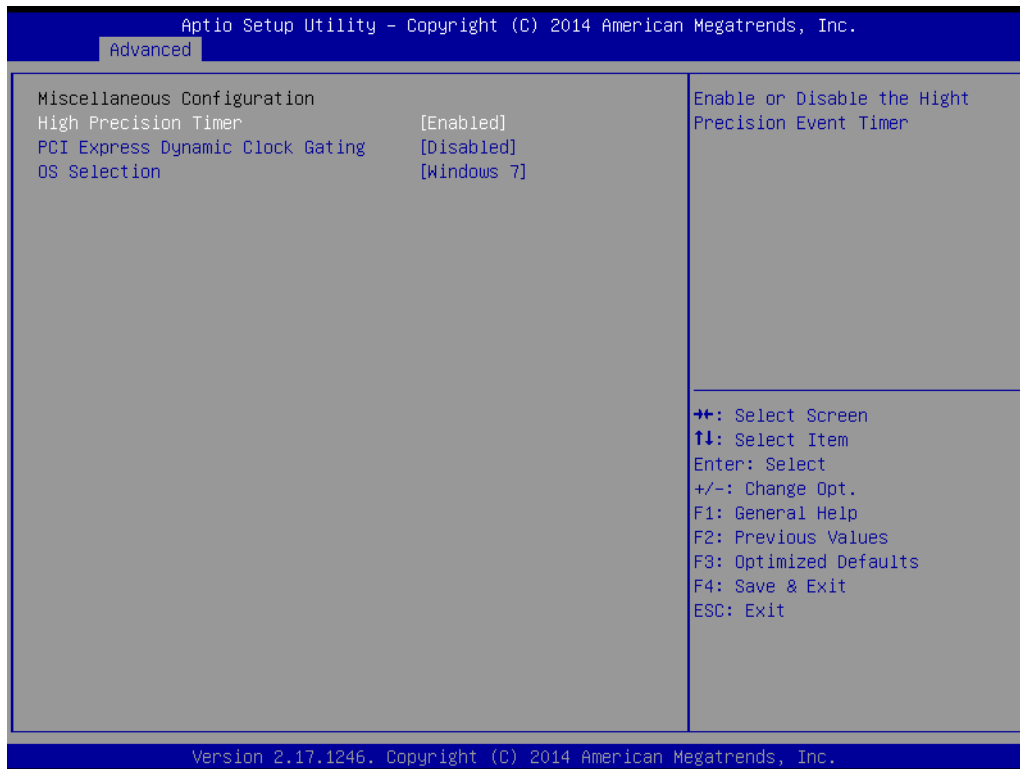

- **High Precision Timer**  
This item allows users to enable or disable the high-precision timer.
- **PCI Express Dynamic Clock Gating**  
This item allows users to enable or disable the PCI Express Dynamic Clock Gating function.
- **OS Selection**  
This item allows users to set the OS as Windows 7 or Windows 8.x.

### 3.2.2.14 PCI Subsystem Settings

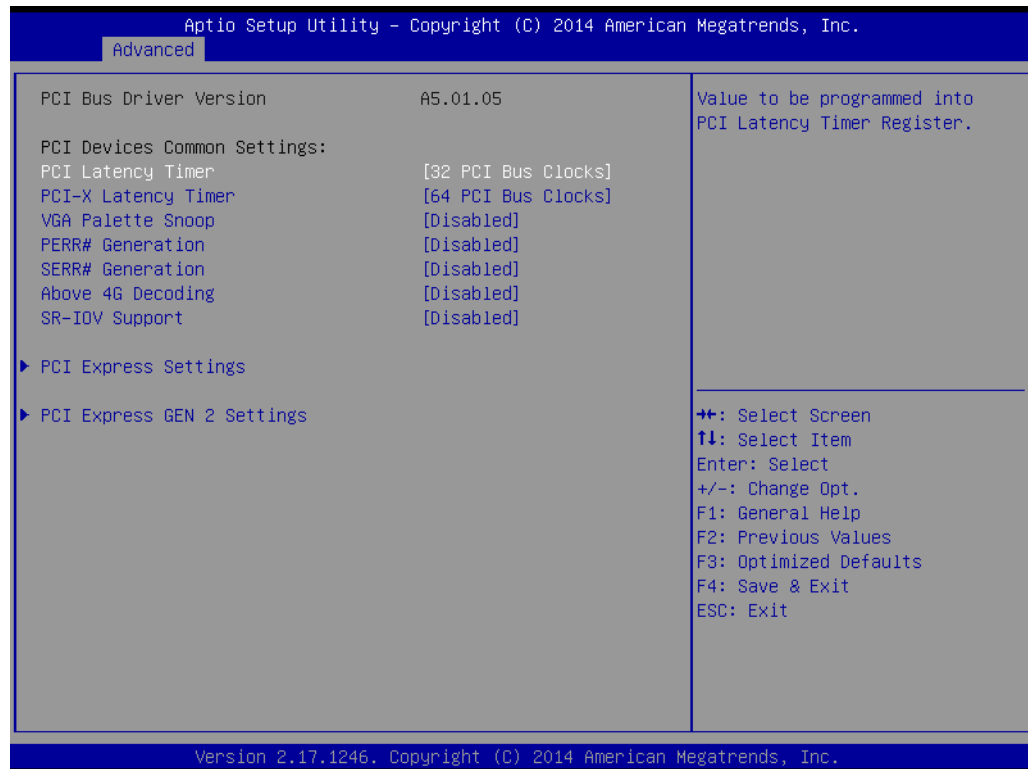

#### General PCI Device Settings

- **PCI Latency Timer**  
This item allows users to program the timer value into the PCI Latency Timer Register.
- **PCI-X Latency Timer**  
Value to be programmed into PCI Latency Timer Register.
- **VGA Palette Snooping**  
This item allows users to enable or disable VGA palette register snooping.
- **PERR# Generation**  
This item allows users to enable or disable PERR# Generation.
- **SERR# Generation**  
This item allows users to enable or disable SERR# Generation.
- **Above 4G Decoding**  
This item allows users to enable or disable 64-bit-capable device decoding in above 4G address spaces (if the system supports 64-bit PCI decoding).
- **SR-IOV Support**  
If the system has SR-IOV-capable PCIe devices, this item allows users to enable or disable single root IO virtualization support.

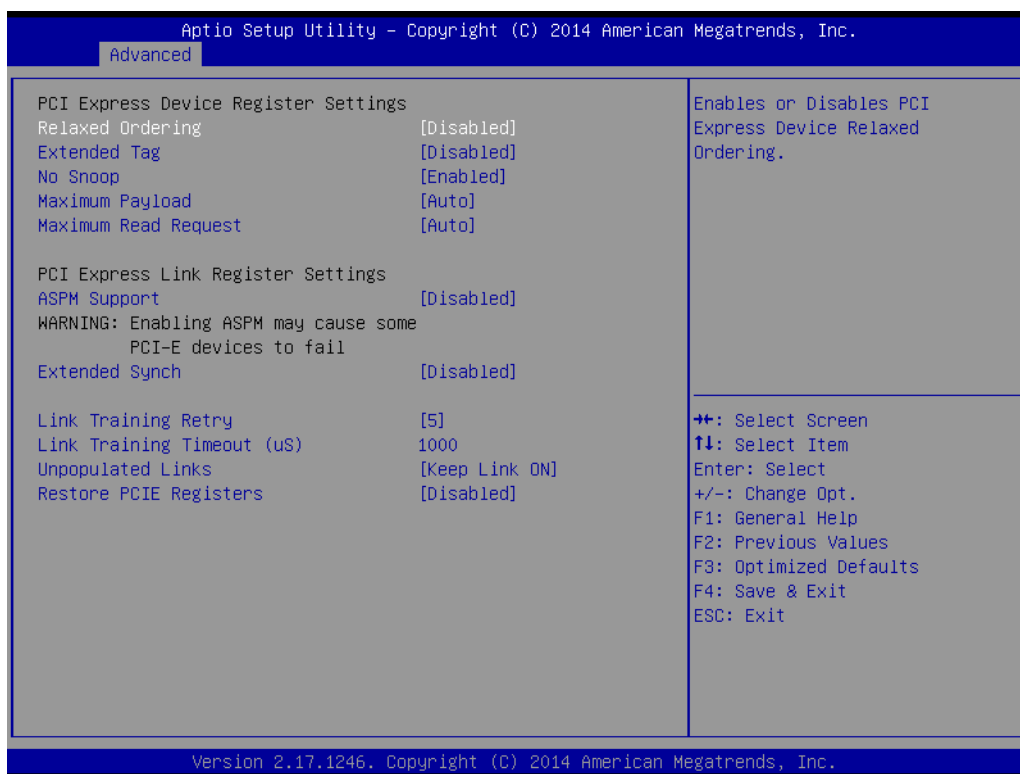

### PCI Express Device Register Settings

- **Relaxed Ordering**  
This item allows users to enable or disable relaxed ordering.
- **Extended Tag**  
This item allows users to enable or disable extended tags.
- **No Snoop**  
This item allows users to enable or disable the No Snooping function.
- **Maximum Payload**  
This item allows users to set the maximum payload for PCI Express devices or authorize the system BIOS to select the value.
- **Maximum Read Request**  
This item allows users to set the maximum read request size for PCI Express devices or authorize the system BIOS to select the value.

### PCI Express Link Register Settings

- **ASPM Support**  
This item allows users to enable or disable ASPM support.
- **Extended Synch**  
This item allows users to enable or disable the Extended Synch function.
- **Link Training Retry**  
This item allows users to define the number of retry attempts for software link training.
- **Link Training Timeout**  
This item allows users to define the number of microseconds the software will wait before polling the “Link Training” bit in the link status register. Values range from 10 to 10000 uS.
- **Unpopulated Links**  
To save power, the software will disable unpopulated PCI Express links if this option set as “Disable Link”.

- **Restore PCIE Registers**

On non-PCI Express aware OS (pre-Windows Vista), some devices may not be correctly re initialized after S3. Enabling this item restores PCI Express device configurations upon S3 resume.

**Warning!** Enabling this item can cause issues with other hardware after S3 resume.



### PCI Express GEN2 Device Register Settings

- **Completion Timeout**

This item is an in-device function that supports Completion Timeout programmability by allowing the system software to modify the Completion Timeout value. The default value is 50us to 50ms. If the “Shorter” option is selected, the software will use the shorter timeout ranges supported by the hardware. If the “Longer” option is selected, the software will use longer timeout ranges.

- **ARI Forwarding**

If supported by the hardware and set to “Enabled”, the downstream port prevents the traditional device number field from being 0 enforcement when turning a Type 1 Configuration Request into a Type 0 Configuration Request, thereby permitting access to the extended functions of the ARI device located below the port. The default value is “Disabled”.

- **AtomicOp Requester Enable**

If supported by the hardware and set to “Enabled”, this function initiates AtomicOp requests only if the Bus Master Enable bit is in the Command Register Set.

- **AtomicOp Egress Blocking**

If supported by the hardware and set to “Enabled”, outbound AtomicOp requests transmitted via egress ports will be blocked.

- **IDO Request Enable**  
If supported by the hardware and set to “Enabled”, this item allows users to set the number of ID-based ordering (IDO) bit (Attribute[2]) requests to be initiated.
- **IDO Completion Enable**  
If supported by the hardware and set to “Enabled”, this item allows users to set the number of IDO bit (Attribute[2]) requests to be initiated.
- **LTR Mechanism Enable**  
If supported by the hardware and set to “Enabled”, the Latency Tolerance Reporting (LTR) mechanism will be activated.
- **End-End TLP Prefix Blocking**  
If supported by the hardware and set to “Enabled”, this function blocks the forwarding of TLPs that contain End-End TLP Prefixes.

### PCI Express Gen2 Link Register Settings

- **Target Link Speed**  
If supported by the hardware and set to “Force to 2.5 GT/s” to downstream ports, users can determine the upper limit link operation speed by restricting the values specified by the upstream component in its training sequences. When the “Auto” option is selected, HW-initialized data will be used.
- **Clock Power Management**  
If supported by the hardware and set to “Enabled”, the device is permitted to use CLKREQ# signals to manage the link clock power according to the protocol defined in an appropriate form factor specification.
- **Compliance SOS**  
If supported by the hardware and set to “Enabled”, this option forces the LTSSM to send SKP-ordered sets between sequences when sending compliance patterns or modified compliance patterns.
- **Hardware Autonomous Width**  
If supported by the hardware and set to “Disabled”, the ability to alter the link width using the hardware is disabled, except by reducing the size to correct unstable link operation.
- **Hardware Autonomous Speed**  
If supported by the hardware and set to “Disabled”, the ability to alter link speed using the hardware is disabled, except by reducing the speed to correct unstable link operation.

### 3.2.2.15 Compatibility Support Module Configuration

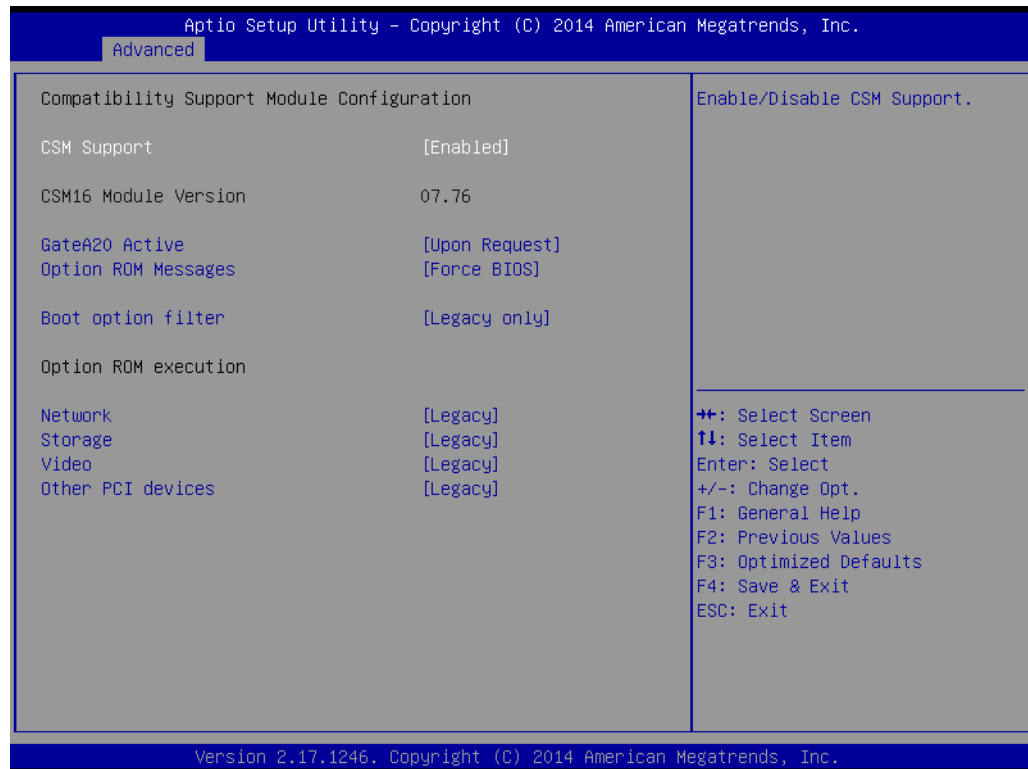

- **CSM Support**  
This item allows users to enable or disable CSM support.
- **GateA20 Active**  
Upon request - GA20 can be disabled using BIOS services. ALWAYS - do not allow disabling GA20; this option is useful when any RT code is executed above 1MB.
- **Option ROM Messages**  
This item allows users to set the display mode for Option ROM.
- **INT19 Trap Response**  
This item allows users to set the BIOS reaction to INT19 trapping by Option ROM: "Immediate" - execute the trap right away; "postponed" - execute the trap during legacy boot.
- **Boot Options Filter**  
This item allows users to control the Legacy/UEFI ROM priority.
- **Option ROM Execution**
  - **Network**  
Controls the execution of UEFI and Legacy PXE OpROM.
  - **Storage**  
Controls the execution of UEFI and Legacy Storage OpROM.
  - **Video**  
Controls the execution of UEFI and Legacy Video OpROM.
  - **Other PCI devices**  
Determines the OpROM execution policy for devices other than network, storage, and/or video devices.



### 3.2.2.16 USB Configuration

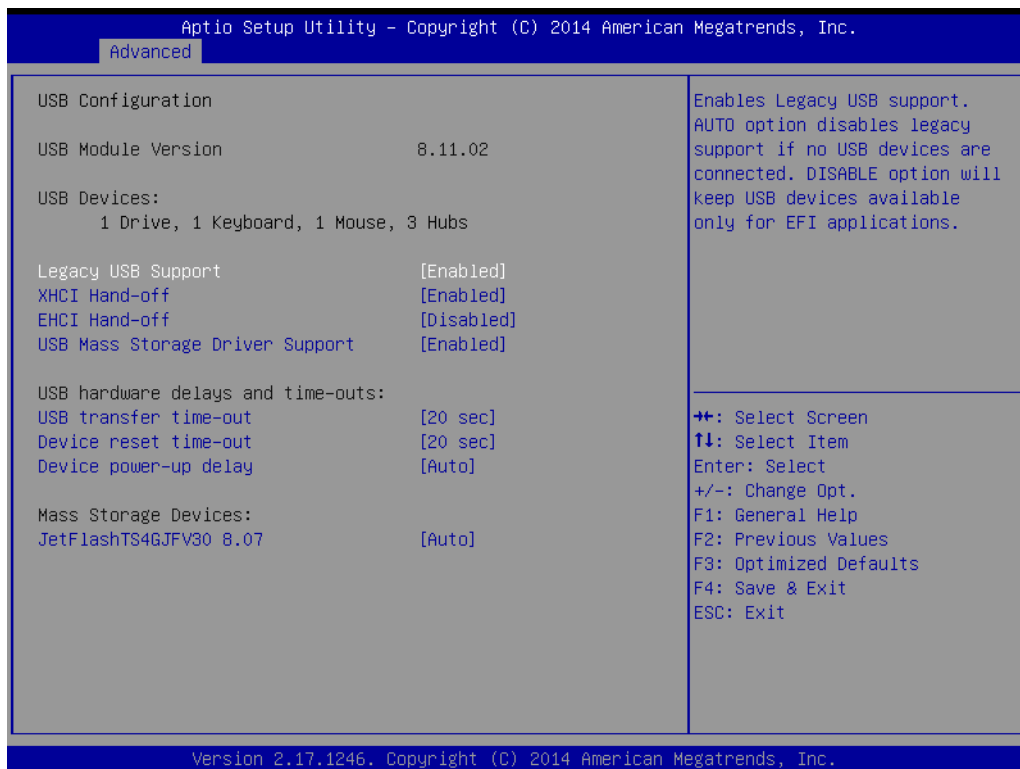

- **Legacy USB support**  
This item allows users to enable or disable support for legacy USB. The “Auto” option disables legacy support if no USB devices are connected.
- **XHCI Hands Off**  
This is a workaround for OS without XHCI hands-off support. The change in XHCI ownership should be claimed by the XHCI driver.
- **EHCI Hands Off**  
This is a workaround for OS without EHCI hands-off support. The change in EHCI ownership should be claimed by the EHCI driver.
- **USB Mass Storage Driver Support**  
This item allows users to enable or disable the USB mass storage driver.
- **USB Transfer Timeouts**  
This item allows users to determine the timeout values for control, bulk, and interrupt transfers.
- **Device Reset Timeout**  
This item allows users to set the USB mass storage device unit command time-out value.
- **Device Power-up Delay**  
Maximum time before the device issues a self-report to the host controller.
- **Mass Storage Device**  
This item allows users to determine the mass storage device emulation type. The “Auto” option enumerates devices according to their media format. Optical drives are emulated as CDRoms, and drives with no media are emulated according to the drive type.

**Note!** When the selected OS is Windows 7, users must install a USB 3.0 XHCI driver.



Please refer to Chapter 8 for information on XHCI driver installation.

### 3.2.2.17 Intel® TXE and Anti-Theft Technology Configuration

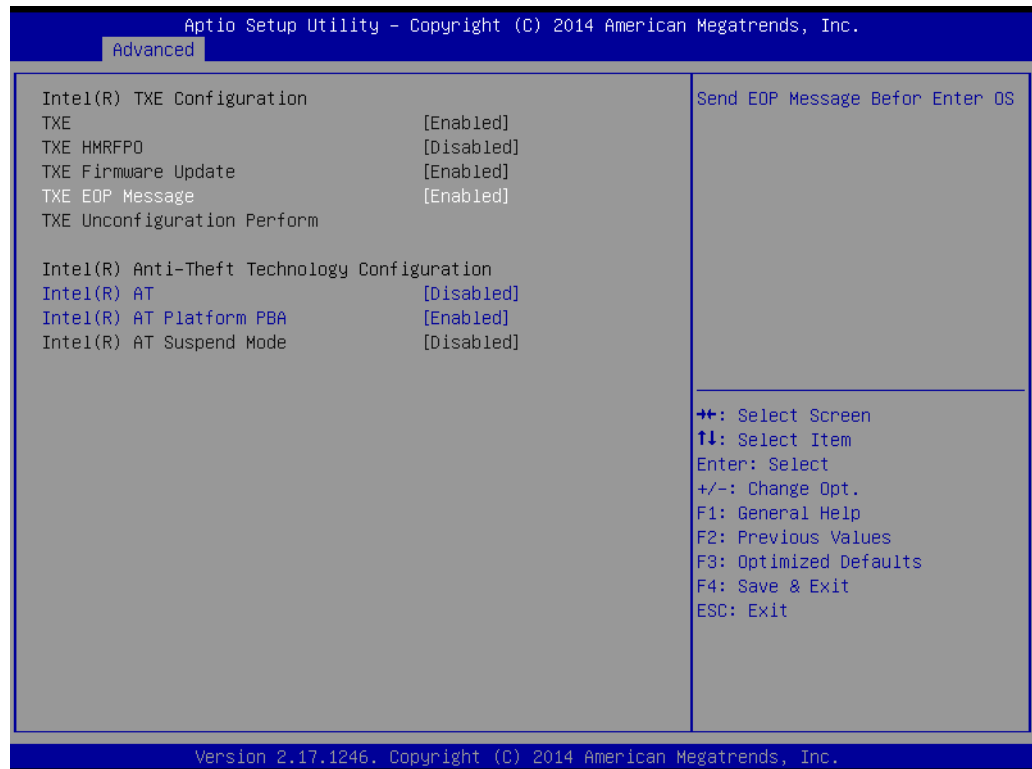

- **TXE**  
This item allows users to enable or disable TXE.
- **TXE HMRFPD**  
This item allows users to enable or disable TXE HMRFPD.
- **TXE Firmware Update**  
This item allows users to enable or disable TXE firmware updates.
- **TXE EOP Message**  
This item allows users to send EOP messages before entering the OS.
- **Intel® AT**  
This item allows users to enable or disable the BIOS AT code from running.
- **Intel® AT Platform PBA**  
This item allows users to enable or disable the BIOS AT code from running.
- **Enter Intel® AT Suspend Mode**  
This item allows users to request that a platform enter AT Suspend mode (this option is only available when AT enrolled).

### 3.2.3 Chipset

This page provides information of the chipset on AIMB-215 B1.



- **North Bridge**  
This item provides details of the North Bridge parameters.
- **South Bridge**  
This item provides details of the South Bridge parameters.

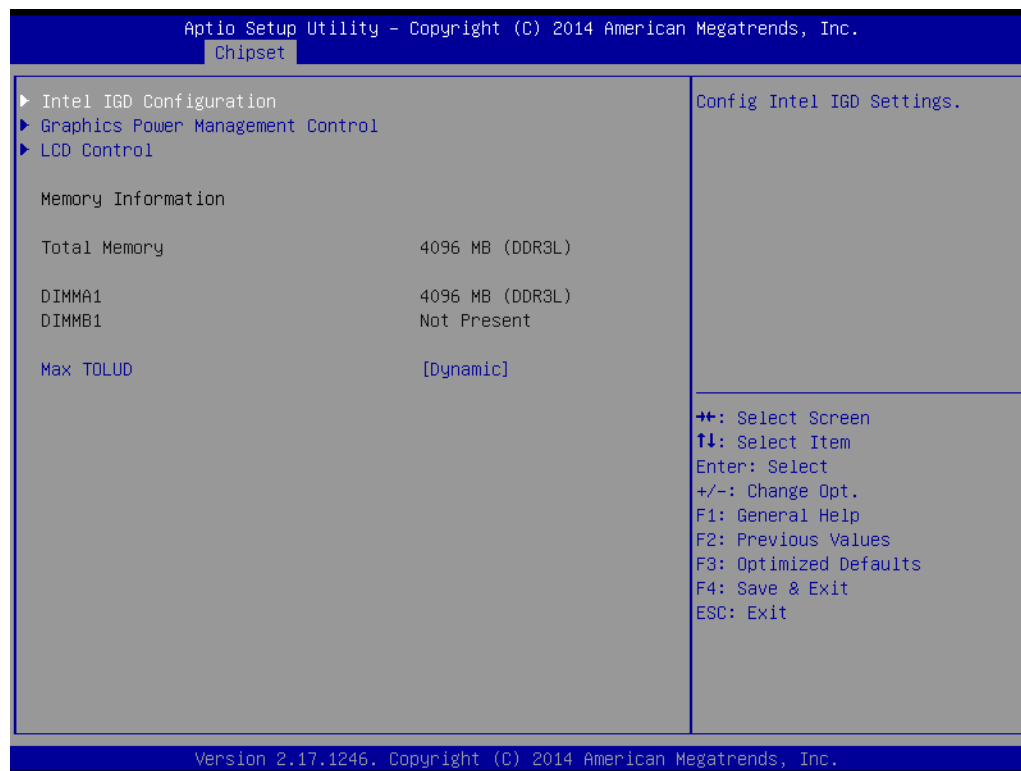

■ **Max TOLUD**

This item allows users to select the maximum TOLUD.

**GOP and Intel IGD Configuration**

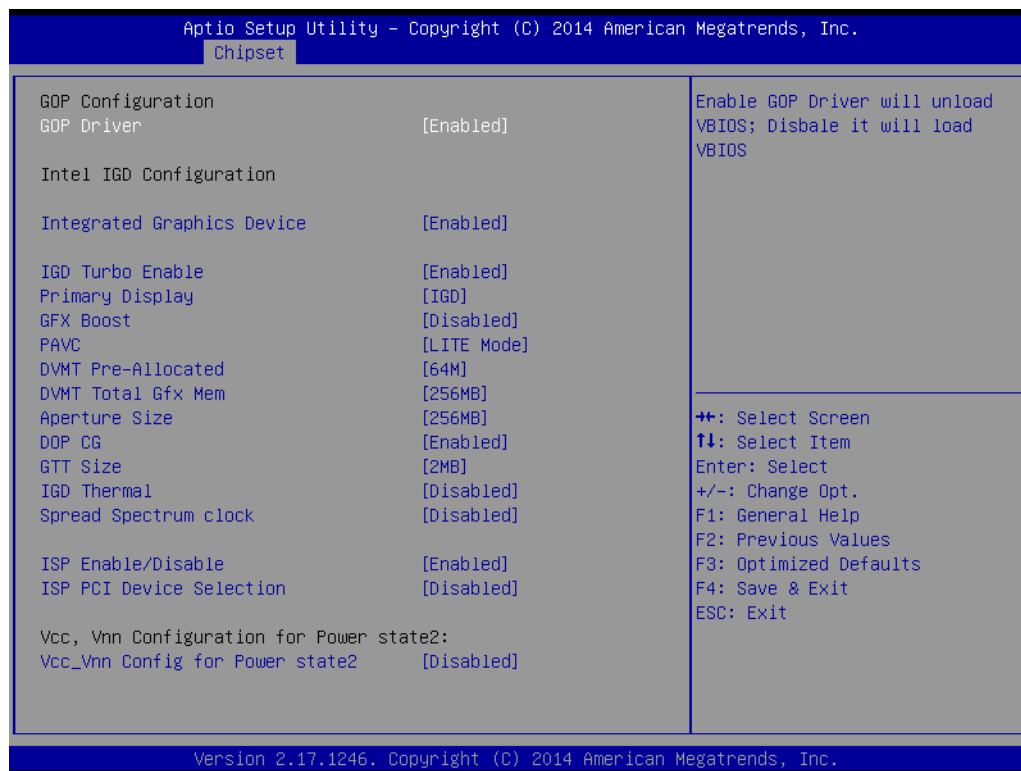

- **GOP Driver**  
This item allows users to enable or disable the GOP driver.
- **Integrated Graphics Device**  
This item allows users to enable or disable an integrated graphics device.
- **IGD Turbo Enable**  
This item allows users to enable or disable the IGD Turbo Enable function.
- **Primary Display**  
This item allows users to select which IGD/PCI graphics device should be used as the primary display.
- **GFX Boost**  
This item allows users to enable or disable GFX Boost.
- **PAVC**  
This item allows users to enable or disable Protected Audio Video Control.
- **DVMT Pre-Allocated**  
This item allows users to specify the DVMT 5.0 pre-allocated (fixed) graphics memory size to be used by the internal graphics device.
- **DVMT Total Gfx Mem**  
This item allows users to specify the DVMT 5.0 total graphics memory size to be used by the internal graphics device.
- **Aperture Size**  
This item allows users to select the aperture size.
- **DOP CG**  
This item allows users to enable or disable DOP CG.
- **GTT Size**  
This item allows users to select the GTT size.
- **IGD Thermal**  
This item allows users to enable or disable IGD thermal control.
- **Spread Spectrum clock**  
This item allows users to enable or disable the spread spectrum clock.
- **ISP Enable/Disable**  
This item allows users to enable or disable ISP function.
- **ISP PCI Device Selection**  
This item allows users to enable or disable ISP PCI device selection.

#### **VCC and VNN Configuration for Power State 2:**

- **Vcc\_Vnn Config for Power State 2**  
This item allows users to enable or disable VCC and VNN Configuration for Power State 2.

## Graphics Power Management Control

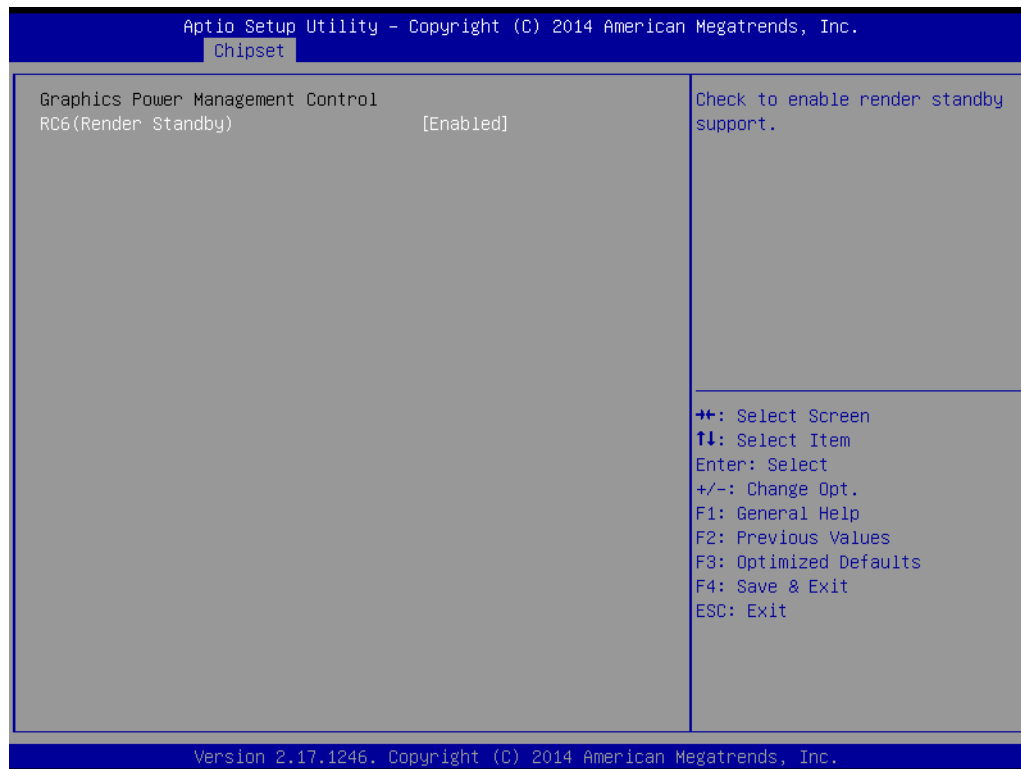

- **RC6 (Render Standby)**  
This item allows users to enable render standby support.

## LCD Control

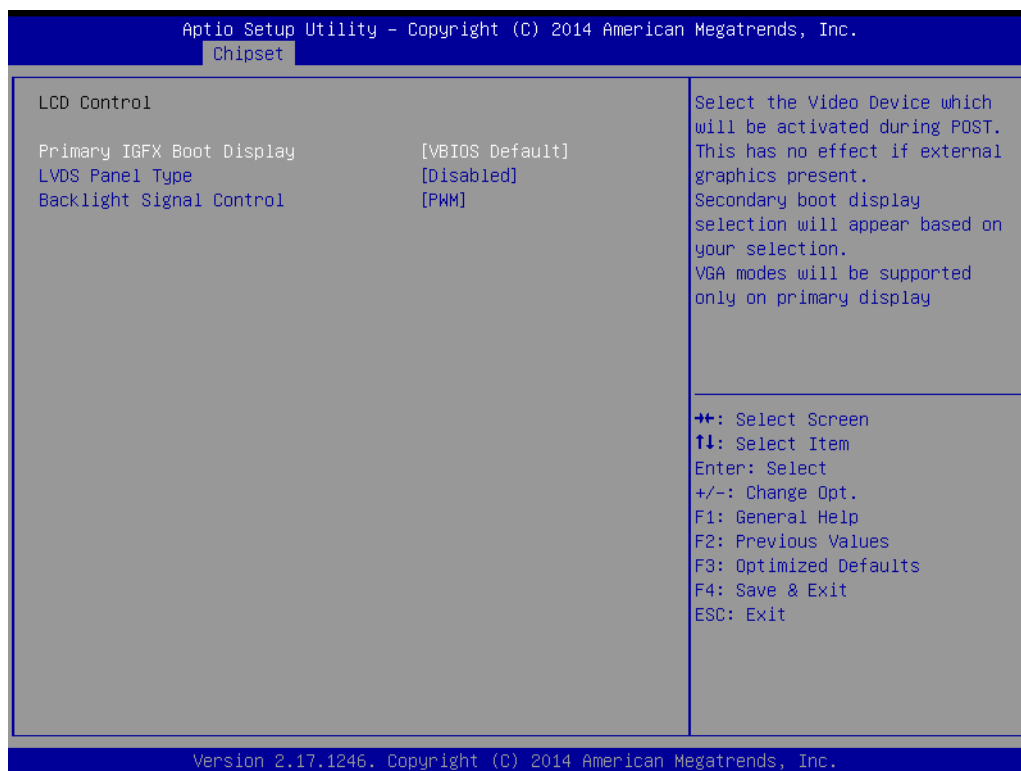

- **Primary IGFX Boot Display (VBIOS Default)**  
This item allows users to select the video device activated during POST. Secondary boot display options are presented according to users' selection.
- **LVDS Panel Type**  
This item allows users to specify the LVDS panel type.
- **Backlight Signal Control**  
This item allows users to set the backlight signal control as PWM or LINEAR.

Two display combinations tables are presented below. All combinations listed in these tables have been tested and verified.

Single Display	BIOS Setup Menu	DOS	Win8
CRT	PASS	PASS	PASS
DP	PASS	PASS	PASS
LVDS	PASS	PASS	PASS

Primary IGFX Boot Display	Secondary IGFX Boot Display	BIOS Setup Menu	DOS Mode	Win8.1 (Extended and Clone modes)
CRT	DP	PASS	Only Primary.	PASS
CRT	LVDS	PASS	Only Primary.	PASS
DP	LVDS	PASS	Only Primary.	PASS

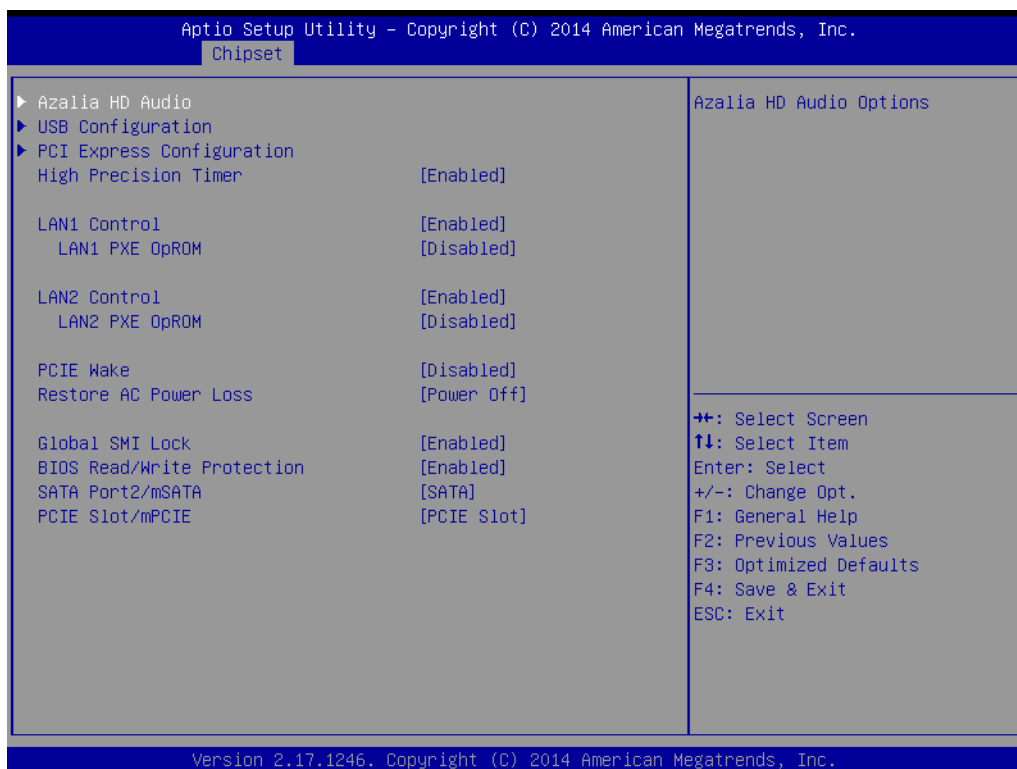

- **Azalia HD Audio**  
This item allows users to adjust the Azalia HD audio options.

- **USB Configuration**  
This item allows users to adjust the USB configuration.
- **PCI Express Configuration**  
This item allows users to adjust the PCI Express configuration.
- **High Precision Timer**  
This item allows users to enable or disable the high-precision timer.
- **LAN 1 controller**  
This item allows users to enable or disable the LAN 1 controller.
- **LAN 1 PXE OpROM**  
This item allows users to enable or disable the LAN 1 option-ROM.
- **LAN 2 controller**  
This item allows users to enable or disable the LAN 2 controller.
- **LAN 2 PXE OpROM**  
This item allows users to enable or disable the LAN 2 option-ROM.
- **PCIe Wake**  
This item allows users to enable or disable the PCIe System Wakeup from S5 function.
- **Restore AC Power Loss**  
The configuration options for this item are “Off”, “On”, and “Last State”.
- **Global SMI Lock**  
This item allows users to enable or disable the Global SMI Lock function.
- **BIOS Read/Write Protection**  
This item allows users to enable or disable BIOS Read/Write Protection.
- **SATA Port 2/mSATA**  
This item allows users to specify SATA Port 2 or mSATA for use.
- **PCIE Slot/mPCIE**  
This item allows users to specify PCIe x1 Port or miniPCIe2 for use.

## Audio Configuration

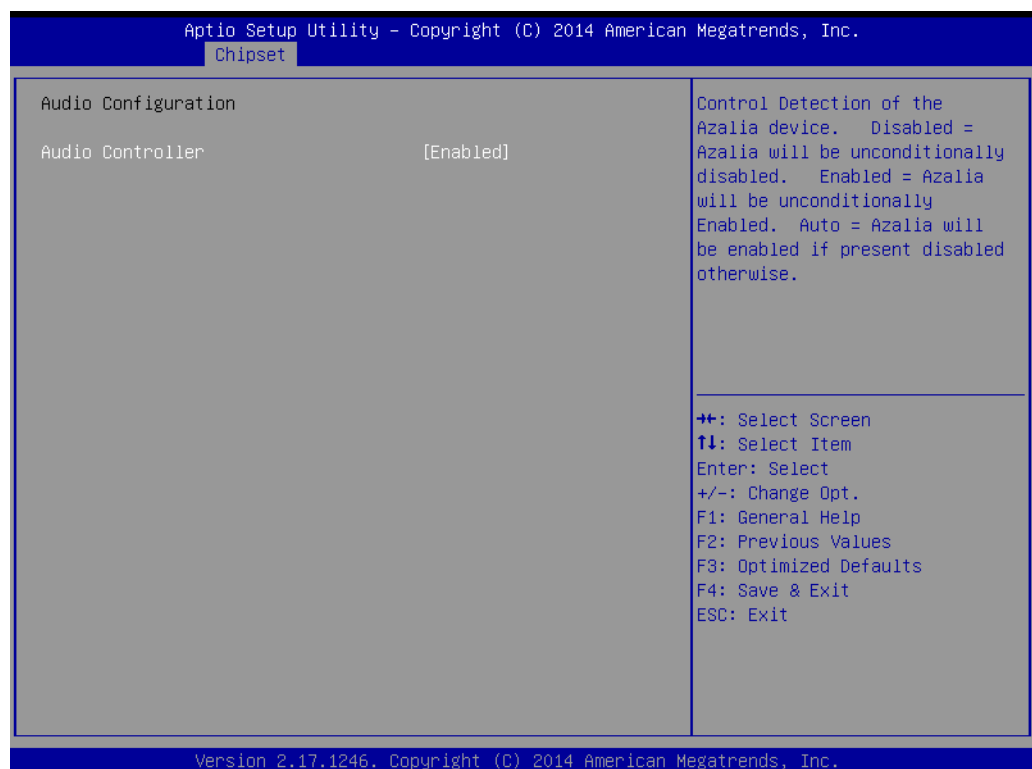



- **Audio Controller**

This item allows users to enable or disable the audio controller.

## USB Configuration

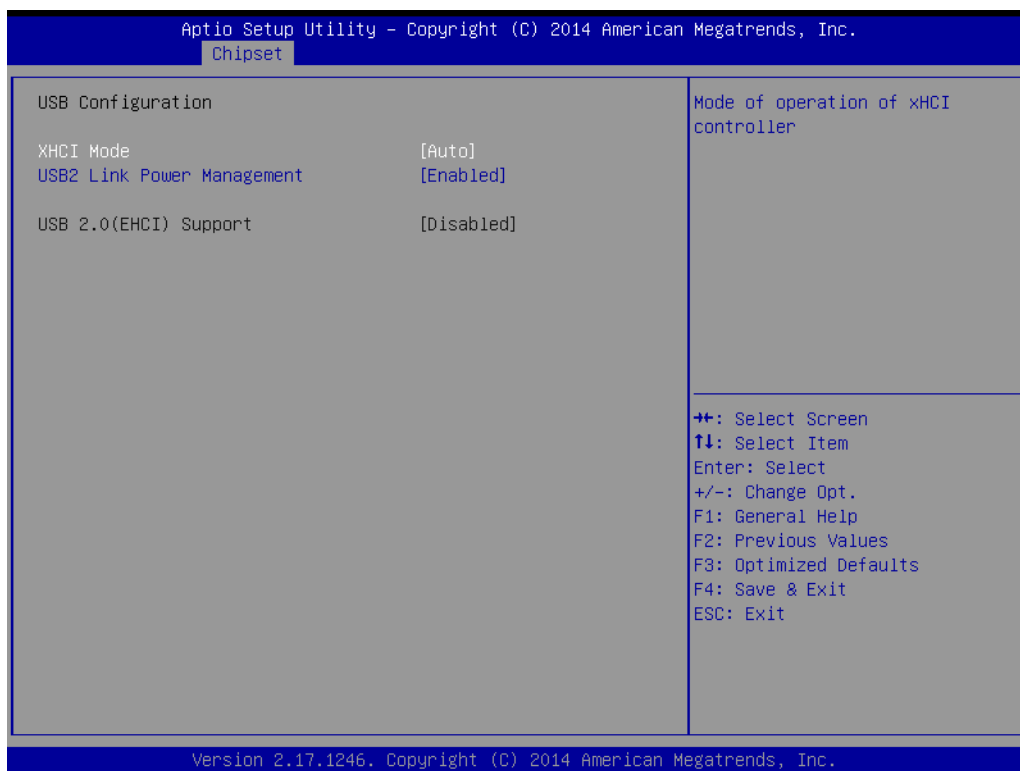

- **XHCI Mode**

This item allows users to enable or disable XHCI mode.

- **USB2 Link Power Management**

This item allows users to enable or disable USB2 link power management.

- **USB 2.0 (EHCI) Support**

This item allows users to enable or disable USB 2.0 (EHCI) support.

**Note!** When the selected OS is Windows 7, users must install a USB 3.0 XHCI driver.



Please refer to Chapter 8 for information on XHCI driver installation.

## PCI Express Configuration

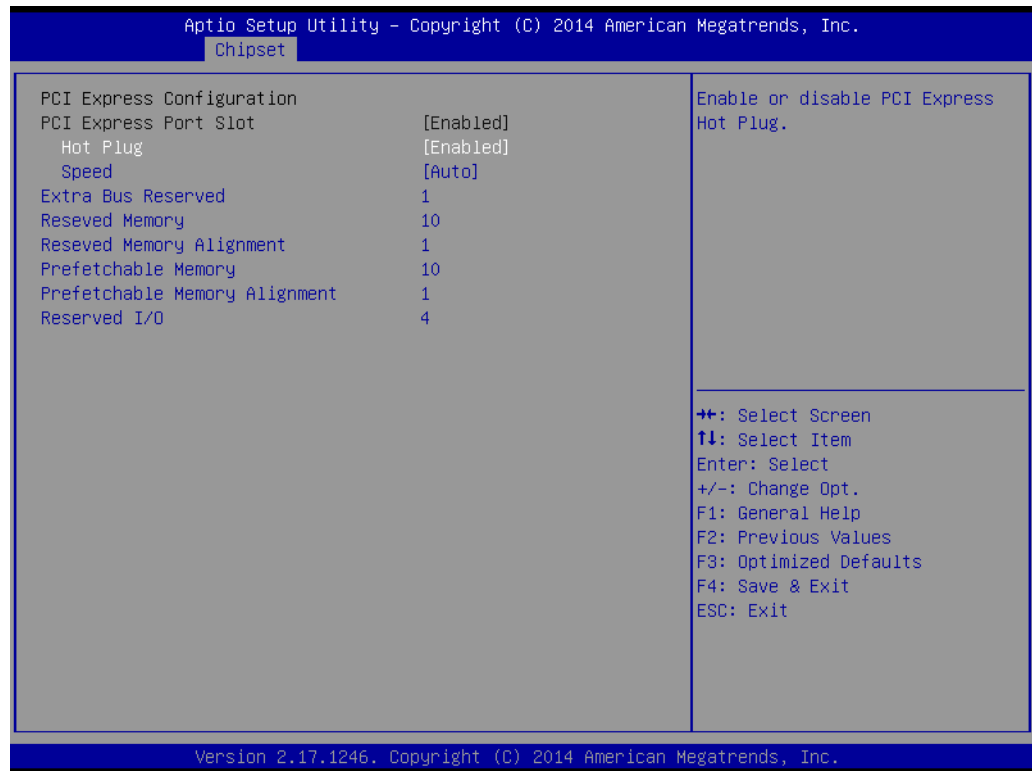

- **PCI Express Port Slot**  
This item allows users to enable or disable the PCI Express port slot.
- **Hot Plug**  
This item allows users to enable or disable the PCI Express hot plug.
- **Speed**  
This item allows users to configure the PCIe port speed.

### 3.2.4 Security

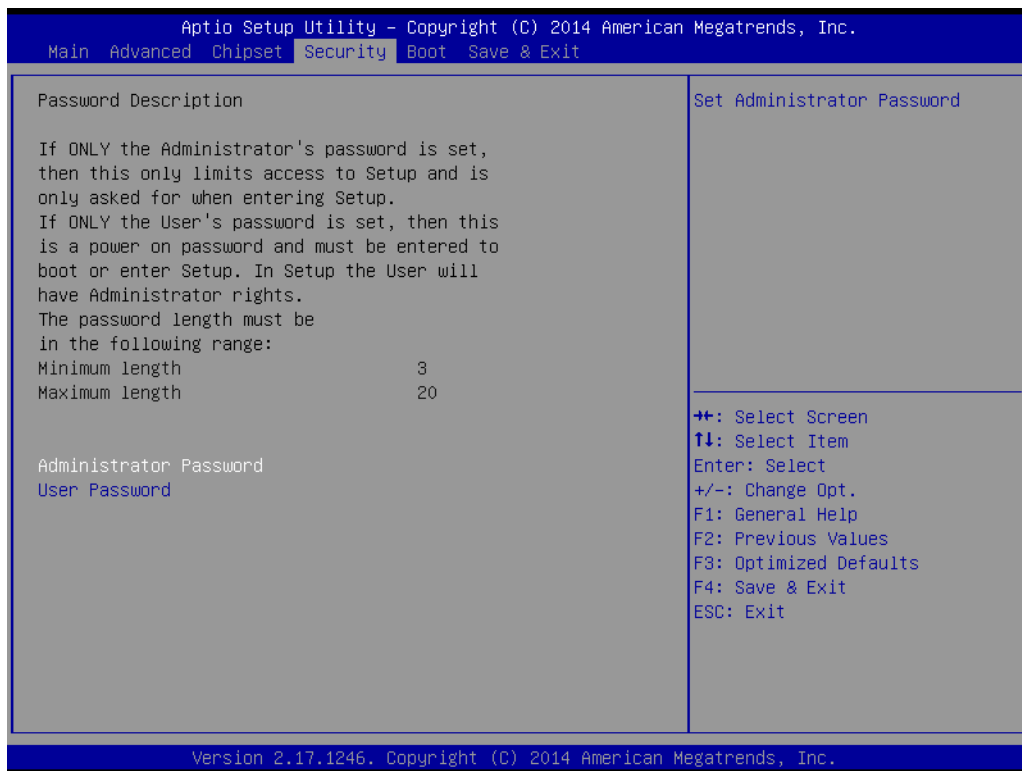

Select the Security tab from the AIMB-215 B1 BIOS Setup Utility main setup menu. All Security options, such as password protection and virus protection, are described in this section. To access the submenus for the “Change Administrator” and “User Password” items, select the item and press <Enter>.

## 3.2.5 Boot

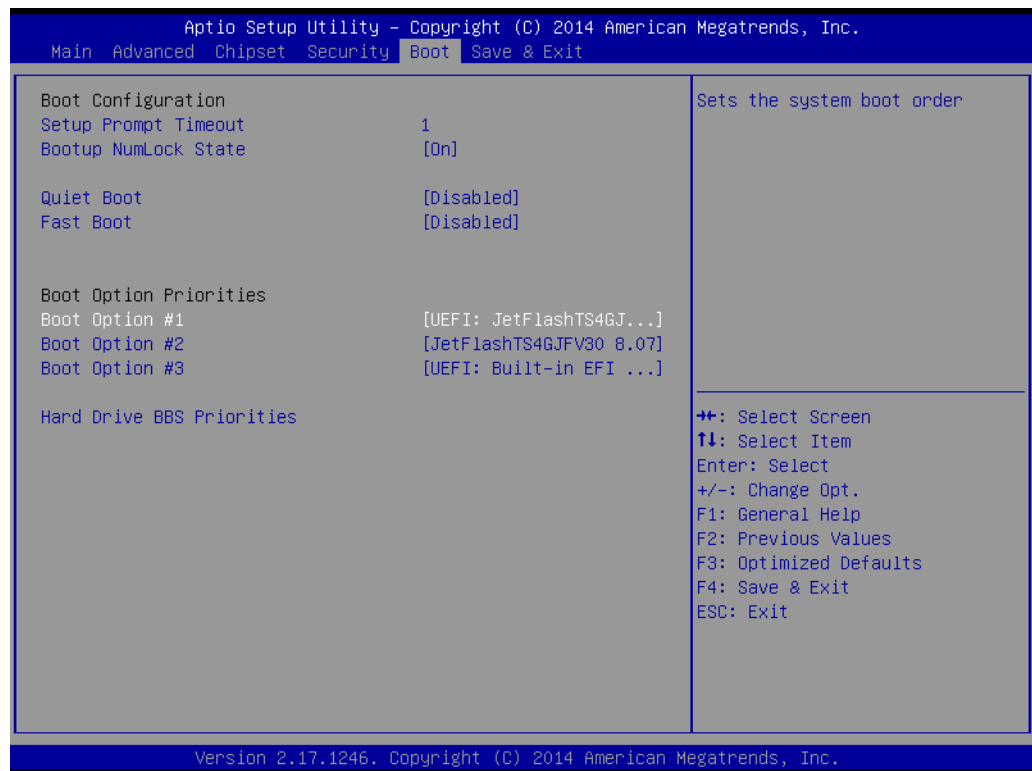

- **Setup Prompt Timeout**  
This item allows users to specify the number of seconds the system should wait for a setup activation key.
- **Bootup NumLock State**  
This item allows users to select the power-on state for Numlock.
- **Quiet Boot**  
If this item is set to “Disabled”, the BIOS displays standard POST messages. If set to “Enabled”, an OEM logo is shown instead of POST messages.
- **Fast Boot**  
This item allows users to enable or disable boot initialization with the minimum number of devices necessary to launch the active boot option. These settings have no effects for BBS boot options.
- **Boot Option Priorities**  
This item allows users to set the system boot order.

### 3.2.6 Save and Exit



- **Save Changes and Exit**  
This item allows users to save changes and exit the system setup page.
- **Discard Changes and Exit**  
This item allows users to exit the system setup without saving changes.
- **Save Changes and Reset**  
This item allows users to reset the system setup after saving changes.
- **Discard Changes and Reset**  
This item allows users to reset the system setup without saving changes.
- **Save Changes**  
This item allows users to save changes to all options.
- **Discard Changes**  
This item allows users to discard changes to all options.
- **Restore Defaults**  
This item allows users to restore/load the default values for all options.
- **Save as User Defaults**  
This item allows users to save changes as user defaults.
- **Restore User Defaults**  
This item allows users to restore the user defaults for all options.
- **Boot Override**  
This item allows users to override boot priority with a selected boot device.
- **Launch EFI Shell From a File system Device**  
This item allows users to launch an EFI Shell application (Shellx64.efi) from an available file system device.



# Chapter 4

Software and Service  
Introduction

## 4.1 Introduction

The mission of Advantech Embedded Software Services is to “enhance users’ quality of life with Advantech platforms and Microsoft® Windows® embedded technology”. We equip Advantech platforms with Windows® embedded software products to more effectively support the embedded computing community. This eliminates the hassle of dealing with multiple vendors (hardware suppliers, system integrators, and embedded OS distributors) for specific projects. Our aim is to make Windows® embedded software solutions widely available to the embedded computing community.

## 4.2 Value-Added Software Services

Software API: An interface that defines the ways in which an application program may request services from libraries and/or operating systems. This software provides not only the underlying drivers required, but also a rich set of user-friendly, intelligent, and integrated interfaces that speed development, enhance security, and offer add-on value for Advantech platforms. Furthermore, this software serves as a catalyst between developers and solutions, making Advantech embedded platforms easier and simpler to adopt and operate with customer applications.

### 4.2.1 Software API

#### 4.2.1.1 Control

##### GPIO



General purpose input/output is a flexible parallel interface that allows various custom connections. This interface also enables users to monitor the level of signal input or set the output status to switch the device on or off. Our API also provides programmable GPIO, enabling developers to dynamically set the GPIO input or output status.

##### SMBus



SMBus is a system management bus defined by Intel Corporation in 1995. This interface is used in personal computers and servers for low-speed system management communications. The SMBus API allows developers to interface with an embedded system environment and transfer serial messages using SMBus protocols, facilitating multiple simultaneous device control.

#### 4.2.1.2 Display

##### Brightness Control



The Brightness Control API allows developers to access embedded devices and easily control brightness.



### Backlight



The Backlight API allows developers to control the backlight (screen) in embedded devices.

#### 4.2.1.3 Monitor

### Watchdog



A watchdog timer is a device that performs a specific operation after a specified period of time when a malfunction occurs and the system cannot recover on its own. A watchdog timer can be programmed to perform a warm booting (system restart) after a certain number of seconds.

### Hardware Monitor



The Hardware Monitor API is a system health supervision API that inspects certain condition indices, such as fan speed, temperature, and voltage.

#### 4.2.1.4 Power Saving

### CPU Speed



This feature uses Intel SpeedStep® Technology to reduce the system power consumption. The system automatically adjusts the CPU speed according to the system load.

### System Throttling

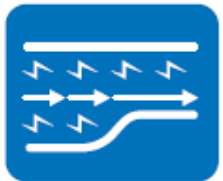

This refers to a series of methods for reducing system power consumption by lowering the clock frequency. This API allows users to adjust the clock frequency from 87.5% to 12.5%.

---

## 4.2.2 Software Utility

### BIOS Flash

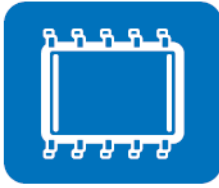

The BIOS Flash utility allows customers to update the flash ROM BIOS version, or backup the current BIOS by copying the configuration from the flash chip to a file on the users' disk. The BIOS Flash utility also features a command line version and API for rapid implementation in customized applications.

### Embedded Security ID



Embedded applications are the most important responsibilities for system integrators because they contain valuable intellectual property, design knowledge, and innovations, and are easily copied. This Embedded Security ID utility offers reliable security functions that allow users to secure application data within embedded BIOS.

### Monitoring



The Monitoring API is a utility that allows users to monitor the system health indicators, such as voltage, CPU and system temperature, and fan speed. These system values are crucial. If critical errors occur and are not solved immediately, permanent damage to the device may result.

# Chapter 5

Chipset Software  
Install Utility

---

## 5.1 Before Installation

Before installing the enhanced display drivers and utility software, please read the instructions provided in this chapter carefully. The drivers for AIMB-215 B1 are provided on the software installation CD. This driver will guide and link users to the utilities and drivers required for Microsoft Windows-based systems. Software updates can be accessed from Microsoft\* software service packs.

**Note!** *The files on the software installation CD are compressed. Do not attempt to install the drivers by copying the files manually. The Setup program provided must be used to install the drivers.*



Please note, for most display drivers, the relevant software application must be installed on the system before enhanced display drivers can be installed. In addition, for many of the installation procedures, user familiarity with both the relevant software applications and operating system commands is assumed. Thus, users are advised to review relevant operating system commands and pertinent sections of the application software user manual before attempting installation.

## 5.2 Introduction

The Intel® Chipset Software Installation (CSI) utility installs the Microsoft Windows INF files that specify the chipset component configuration on the OS. This is essential to enable the following features and functionalities:

- Core PCI PnP services
- IDE Ultra ATA 100/66/33 and Serial ATA interface support
- USB 1.1/2.0/3.0 support (a USB 3.0 XHCI driver must be installed for Windows 7)
- Identification of Intel® chipset components in the device manager
- Integration of superior video features, including filtered sealing of 720 pixel DVD content and MPEG-2 motion compensation for software DVD.

# Chapter 6

## VGA Setup

## 6.1 Introduction

To benefit from the Intel® Celeron™ J1900/N2930/N2807 integrated graphics controller, users must install the graphics driver.

## 6.2 Windows 7/8.1

**Note!** Before installing this driver, ensure the CSI utility is installed on the system. See Chapter 5 for information regarding installing the CSI utility.



Insert the driver CD into the system CD-ROM drive to access the driver folder items. Navigate to the “VGA” folder and click “setup.exe” to initiate the installation of drivers for Windows 7 and Windows 8.1.



# Chapter 7

## LAN Configuration

## 7.1 Introduction

The AIMB-215 B1 system features dual Gigabit Ethernet LANs via dedicated PCI Express x1 lanes (Realtek RTL8111E (LAN1) and Realtek RTL8111E (LAN2)) that offer a bandwidth of up to 500 MB/sec, eliminating bottlenecks in the flow of network data by incorporating Gigabit Ethernet at 1000 Mbps.

## 7.2 Features

- Integrated 10/100/1000 Mbps transceiver
- 10/100/1000 Mbps triple-speed MAC
- High-speed RISC core with 24-KB cache
- On-chip voltage regulation
- Wake-on-LAN (WOL) support
- PCI Express X1 host interface

## 7.3 Installation

**Note!** Before installing LAN drivers, ensure the CSI utility is installed on the system. See Chapter 5 for information regarding installing the CSI utility.



The Realtek 8111E (LAN1) and Realtek 8111E (LAN2) Gigabit integrated controllers support all major network operating systems. However, the installation procedure varies between systems. Please follow the driver setup procedure instructions specific to the operating system installed.

## 7.4 Windows 7/8.1 Driver Setup (Realtek 8111E)

Insert the driver CD into the system CD-ROM drive, open the LAN folder, and then navigate to the directory for the correct OS.





# Chapter 8

## XHCI Driver Installation

## 8.1 Introduction

The XHCI driver is only built into the Window 8.x OS, not Windows 7.  
If the selected OS is Windows 7, users must install the USB 3.0 XHCI driver.

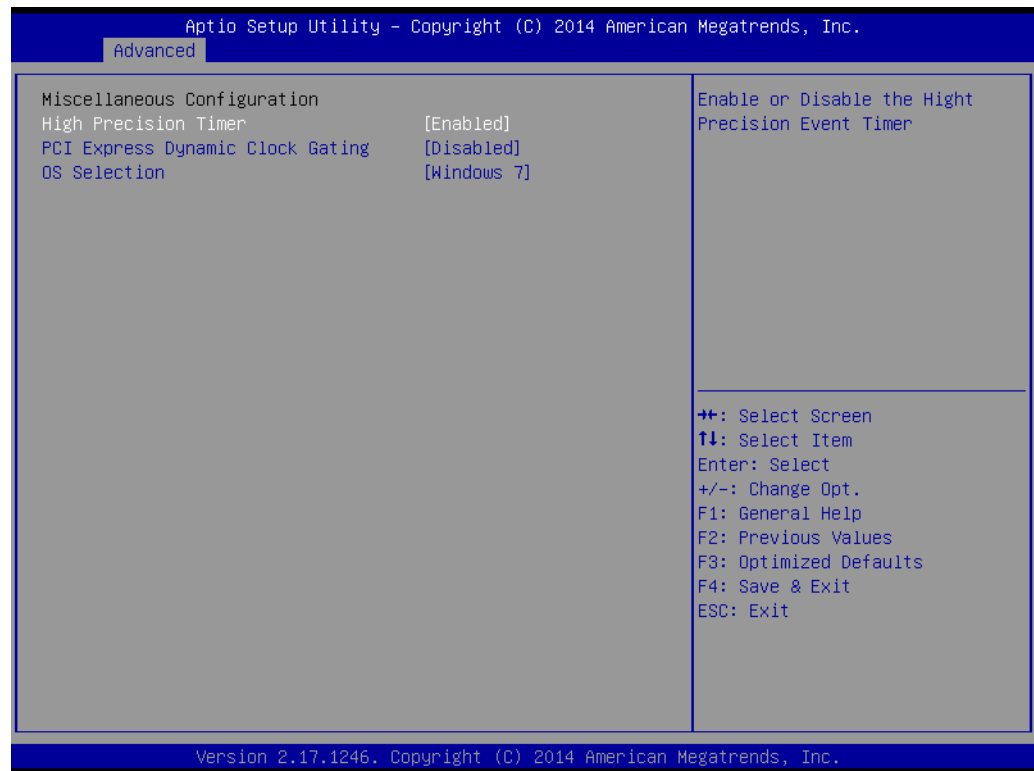

## 8.2 Installation

Insert the driver CD into the system CD-ROM drive, open the USB3 folder, and then navigate to the directory for the correct OS.



**Note!** *For systems with Windows 7 as the OS, only USB 1/2/5/6 are operational prior to the USB 3.0 XHCI driver installation.*



*Users must install the USB 3.0 XHCI driver to ensure all USB ports are operational.*



# Appendix **A**

Programming the  
Watchdog Timer

---

## A.1 Programming the Watchdog Timer

The AIMB-215 B1 watchdog timer can be used to monitor system software operations and execute corrective actions if the software fails to function within the programmed period. The operations and procedures for programming the watchdog timer are described in this section.

### A.1.1 Watchdog Timer Overview

The watchdog timer is built into the NCT6106D super I/O controller, and facilitates the following user-programmable functions:

- Can be enabled and disabled via a user program
- The timer interval can be set as 1 to 255 seconds or 1 to 255 minutes
- Generates an interrupt or reset signal if the software fails to reset the timer before timeout

### A.1.2 Programming the Watchdog Timer

The I/O port base addresses for the watchdog timer are 2E (hex) and 2F (hex), where 2E (hex) is the address port, and 2F (hex) is the data port. Users must first assign register addresses by inputting an address value into address port 2E (hex) before writing/reading data to/from the assigned register through data port 2F (hex).

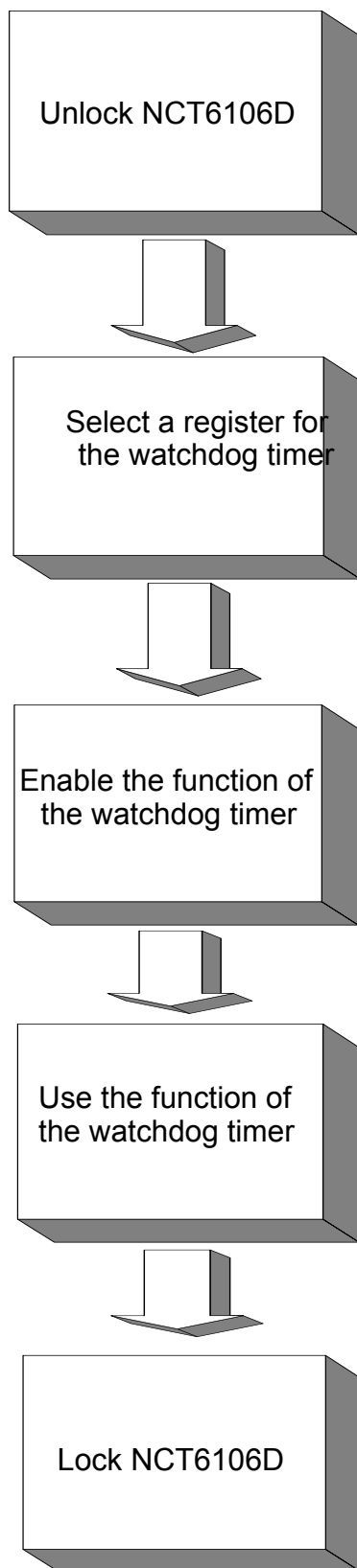

**Table A.1: Watchdog Timer Registers**

<b>Register Address (2E)</b>	<b>Attribute</b>	
Read/Write	Value (2F) and description	
87 (hex)	-----	Write this address to I/O address port 2E (hex) twice to unlock NCT6106D.
07 (hex)	write	Write 08 (hex) to the selected watchdog timer register.
30 (hex)	write	Write 01 (hex) to enable the function of the watchdog timer. The default setting is "Disabled".
F0 (hex)	write	Set the timer unit as seconds or minutes. Write 0 to bit 3: set the unit of measurement as seconds (default). Write 1 to bit 3: set the unit of measurement as minutes.
F1 (hex)	write	0: stop timer (default) 01~FF (hex): The timer value, in seconds or minutes, depends on the value set in Register F5 (hex). This value determines how long the watchdog timer waits for the strobe before generating an interrupt or reset signal. Writing a new value to this register resets the timer to count using the new value.
F2 (hex)	read/write	Bit 7: Write 1 to enable the mouse to reset the timer, or 0 to disable this function (default). Bit 6: Write 1 to enable the keyboard to reset the timer, or 0 to disable this function (default). Bit 5: Write 1 to immediately generate a timeout signal before automatically returning to 0 (default = 0). Bit 4: Read the watchdog timer status, 1 means the timer has reach timeout.
AA (hex)	-----	Write this address to I/O port 2E (hex) to lock the watchdog timer.



### A.1.3 Example Program

1. Enable the watchdog timer and set the timeout interval as 10 seconds

```

;-----
Mov dx,2eh; unlock NCT6106D
Mov al,87h
Out dx,al
Out dx,al
;-----
Mov al,07h; select the watchdog timer registers
Out dx,al
Inc dx
Mov al,08h
Out dx,al
;-----
Dec dx; enable the watchdog timer function
Mov al,30h
Out dx,al
Inc dx
Mov al,01h
Out dx,al
;-----
Dec dx; set the unit of measurement as seconds
Mov al,0f0h
Out dx,al
Inc dx
In al,dx
And al,not 08h
Out dx,al
;-----
Dec dx; set the timeout interval as 10 seconds and start counting
Mov al,0f1h
Out dx,al
Inc dx
Mov al,10
Out dx,al
;-----
Dec dx; lock NCT6106D
Mov al,0aah
Out dx,al

```

2. Enable the watchdog timer and set the timeout interval as 5 minutes

```

;-----
Mov dx,2eh; unlock NCT6106D
Mov al,87h
Out dx,al
Out dx,al

```

```

;-----
Mov al,07h; select the watchdog timer registers
Out dx,al
Inc dx
Mov al,08h
Out dx,al
;-----
Dec dx; enable the watchdog timer function
Mov al,30h
Out dx,al
Inc dx
Mov al,01h
Out dx,al
;-----
Dec dx; set the unit of measurement as minutes
Mov al,0f0h
Out dx,al
Inc dx
In al,dx
Or al,08h
Out dx,al
;-----
Dec dx; set the timeout interval as 5 minutes and start counting
Mov al,0f1h
Out dx,al
Inc dx
Mov al,5
Out dx,al
;-----
Dec dx; lock NCT6106D
Mov al,0aah
Out dx,al
3. Enable the watchdog timer to be reset using a mouse
;-----
Mov dx,2eh; unlock NCT6106D
Mov al,87h
Out dx,al
Out dx,al
;-----
Mov al,07h; select the watchdog timer registers
Out dx,al
Inc dx
Mov al,08h
Out dx,al
;-----

```

```

Dec dx; enable the watchdog timer function
Mov al,30h
Out dx,al
Inc dx
Mov al,01h
Out dx,al
;-----
Dec dx; enable the watchdog timer to be reset using a mouse
Mov al,0f2h
Out dx,al
Inc dx
In al,dx
Or al,80h
Out dx,al
;-----
Dec dx; lock NCT6106D
Mov al,0aah
Out dx,al
4. Enable the watchdog timer to be reset using a keyboard
;-----
Mov dx,2eh; unlock NCT6106D
Mov al,87h
Out dx,al
Out dx,al
;-----
Mov al,07h; select the watchdog timer registers
Out dx,al
Inc dx
Mov al,08h
Out dx,al
;-----
Dec dx; enable the watchdog timer function
Mov al,30h
Out dx,al
Inc dx
Mov al,01h
Out dx,al
;-----
Dec dx; enable the watchdog timer to be strobed reset using a keyboard
Mov al,0f2h
Out dx,al
Inc dx
In al,dx
Or al,40h
Out dx,al

```

```

;-----
Dec dx; lock NCT6106D
Mov al,0aah
Out dx,al
5. Generate a timeout signal without the timer counting
;-----
Mov dx,2eh; unlock NCT6106D
Mov al,87h
Out dx,al
Out dx,al
;-----
Mov al,07h; select the watchdog timer registers
Out dx,al
Inc dx
Mov al,08h
Out dx,al
;-----
Dec dx; enable the watchdog timer function
Mov al,30h
Out dx,al
Inc dx
Mov al,01h
Out dx,al
;-----
Dec dx; generate a timeout signal
Mov al,0f2h
Out dx,al; write 1 to Bit 5 of Register F7
Inc dx
In al,dx
Or al,20h
Out dx,al
;-----
Dec dx; lock NCT6106D
Mov al,0aah
Out dx,al

```

# Appendix **B**

I/O Pin Assignments

## B.1 DC-IN Adaptor Connector (DCIN1)

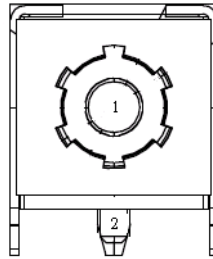

Pin	Signal	Pin	Signal
1	VCC	2	VCC

## B.2 Display Port Connector (DP1)

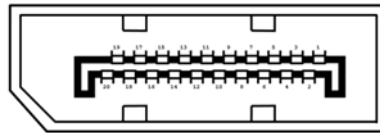

Pin	Signal	Pin	Signal
1	ML_LANE0+	2	GND
3	ML_LANE0-	4	ML_LANE1+
5	GND	6	ML_LANE1-
7	ML_LANE2+	8	GND
9	ML_LANE2-	10	ML_LANE3+
11	GND	12	ML_LANE3-
13	Config 1	14	GND
15	AUX_CH+	16	GND
17	AUX_CH-	18	Hot Plug Detect
19	GND	20	+3.3V

### B.3 eDP Panel Voltage Selection (JEDP-1 + JEDP-2) (BOM Optional)

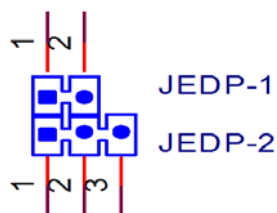

#### JEDP-1

Pin	Signal	Pin	Signal
1	N.C	2	+V12

#### JEDP-2

Pin	Signal	Pin	Signal
1	+V3.3	3	+V5
2	VCC_eDP		

### B.4 VGA Connector (VGA1)

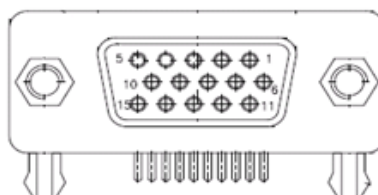

Pin	Signal	Pin	Signal
1	RED	9	VCC
2	GREEN	10	SGND
3	BLUE	11	N.C.
4	GND	12	SDA
5	VCC	13	HSYNC
6	RED GND	14	VSYNC
7	GREEN GND	15	SCL
8	BLUE GND		

## B.5 Serial ATA Interface Connector (SATA2)



Pin	Signal	Pin	Signal
1	GND	5	RX-
2	TX+	6	RX+
3	TX-	7	GND
4	GND		

## B.6 SATADOM Power Pin Header (JSATAPWR1)



Pin	Signal
1	GND
2	SATA_DOM
3	+V5

## B.7 Serial ATA Interface Connector (SATA1)

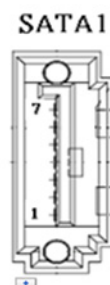

Pin	Signal	Pin	Signal
1	GND	5	RX-
2	TX+	6	RX+
3	TX-	7	GND
4	GND		



## B.8 CMOS Battery Wafer Box (BAT1)



Pin	Signal	Pin	Signal
1	VBAT	5	GND

## B.9 System Fan Connector (SYSFAN2)



Pin	Signal	Pin	Signal
1	GND	3	FAN SPEED
2	VCC_FAN	4	PWM

## B.10 USB3.0 + USB2.0 Stack Connector (USB0102)

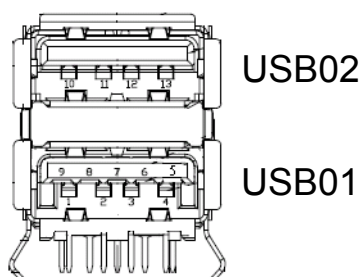

Pin	Signal	Pin	Signal
1	VBUS_2	8	StdA_SSTX-
2	D-_2	9	StdA_SSTX+
3	D+_2	10	VBUS_1
4	GND_2	11	D-_1
5	StdA_SSRX-	12	D+_1
6	StdA_SSRX+	13	GND_1
7	GND_DRAIN	14	

## B.11 SPI BIOS Socket (SPI1)

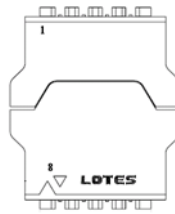

Pin	Signal	Pin	Signal
1	CE#	5	SI
2	SO	6	SCK
3	WP#	7	HOLD#
4	GND	8	VCC_SPI

## B.12 USB2.0 \* 2 Stack Connector (USB0304)

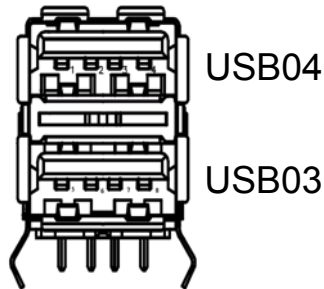

Pin	Signal	Pin	Signal
1	VCC_USB0	5	VCC_USB1
2	USB-0_B	6	USB-1_B
3	USB+0_B	7	USB+1_B
4	GND_1	8	GND_2

## B.13 COM1 Box Header (COM1)

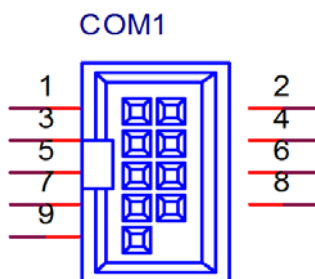

Pin	Signal	Pin	Signal
1	DCD#	2	DSR#
3	SIN	4	RTS#
5	SOUT	6	CTS#
7	DTR#	8	RI#
9	GND		

## B.14 Watchdog Timer Output and OBS Beep (JOBS1 + JWDT1)



Pin	Signal
1	NC
2	WDT
3	RESET#
4	SIO BEEP
5	FRP BEEP

## B.15 RJ45 (LAN1 + LAN2) Connector (LAN12)

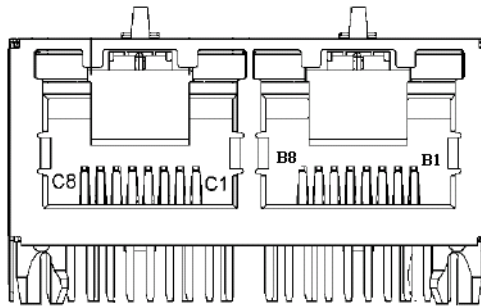

Pin	Signal	Pin	Signal
B1	LAN1_MID0+	C1	LAN2_MID0+
B2	LAN1_MID0-	C2	LAN2_MID0-
B3	LAN1_MID1+	C3	LAN2_MID1+
B4	LAN1_MID1-	C4	LAN2_MID1-
B5	LAN1_MID2+	C5	LAN2_MID2+
B6	LAN1_MID2-	C6	LAN2_MID2-
B7	LAN1_MID3+	C7	LAN2_MID3+
B8	LAN1_MID3-	C8	LAN2_MID3-

## B.16 SPDIF Interface Pin Header (SPDIF\_OUT1)



Pin	Signal
1	+5V
2	KEY
3	SPDIF OUT
4	GND

## B.17 HD Analog Audio Interface (AUDIO1)

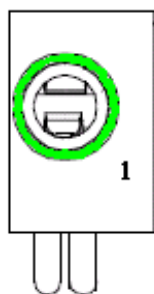

Pin	Signal
1	LINE OUT

## B.18 Front Panel Audio Pin Header (FPAUD1)

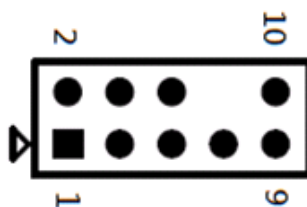

Pin	Signal	Pin	Signal
1	MIC IN-L	2	GND
3	MIC IN-R	4	FPAUD_DETECT#
5	LINE OUT-R	6	SENSE R1
7	SENSE	8	KEY
9	LINE OUT-L	10	SENSE R2

## B.19 Audio Amplifier Output Pin Header (JAMP1) (BOM Optional)

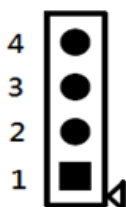

Pin	Signal
1	AMP_OUT-L
2	AMP_OUT+L
3	AMP_OUT-R
4	AMP_OUT+R

## B.20 LVDS VESA and JEIDA Format Pin Header

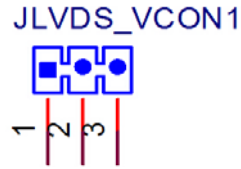

Pin	Signal	Pin	Signal
1	+V3.3	3	GND
2	LVDS1_VCON		

## B.21 LVDS Panel Connector (LVDS1)

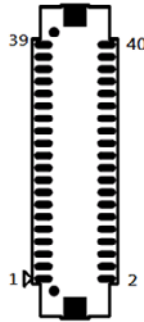

Pin	Signal	Pin	Signal
1	VDD	2	VDD
3	LVDS DETECT#	4	GND
5	VDD	6	VDD
7	OD0-	8	ED0-
9	OD0+	10	ED0+
11	GND	12	GND
13	OD1-	14	ED1-
15	OD1+	16	ED1+
17	GND	18	GND
19	OD2-	20	ED2-
21	OD2+	22	ED2+
23	GND	24	GND
25	OCK-	26	ECK-
27	OCK+	28	ECK+
29	GND	30	GND
31	DDC CLK	32	DDC DAT
33	GND	34	GND
35	OD3-	36	ED3-
37	OD3+	38	ED3+

39	LVDS ENBKL	40	LVDS VCON
----	------------	----	-----------

Pin 3: GND → Panel connected

NC/3.3 V → No panel

## B.22 Dual-Port USB2.0 Box Header (USB0506)

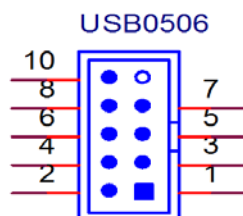

Pin	Signal	Pin	Signal
1	VCC_USB1	2	VCC_USB2
3	USB1-	4	USB2-
5	USB1+	6	USB2+
7	GND	8	GND
9	X	10	N.C

## B.23 LVDS Panel Voltage Selection (JLVDS1 + JLVDS2)

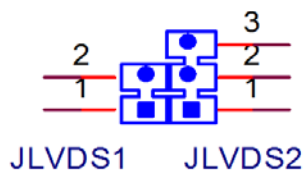

### JLVDS1

Pin	Signal	Pin	Signal
1	N.C	2	+V12

### JLVDS2

Pin	Signal	Pin	Signal
1	+V3.3	3	+V5
2	VCC_LVDS		

## B.24 COM6 RI# Selection Pin Header (JSETCOM6\_V1)

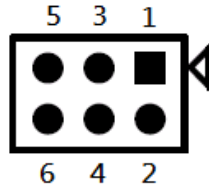

Pin	Signal	Pin	Signal
1	RI#	2	RI#_VCON
3	RI#_VCON	4	+5V
5	+12V	6	RI#_VCON

## B.25 LVDS Backlight Inverter Power Connector (INV1)

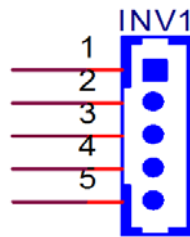

Pin	Signal	Pin	Signal
1	+V12	4	Backlight CTRL
2	GND	5	+V5
3	Backlight EN		

## B.26 8-bit General Purpose I/O Pin Header (GPIO1)

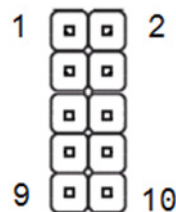

Pin	Signal	Pin	Signal
1	SIO_GPIO0	2	SIO_GPIO4
3	SIO_GPIO1	4	SIO_GPIO5
5	SIO_GPIO2	6	SIO_GPIO6



7	SIO_GPIO3	8	SIO_GPIO7
9	VCC	10	GND

## B.27 COM3 ~ COM6 Box Header (COM3456)

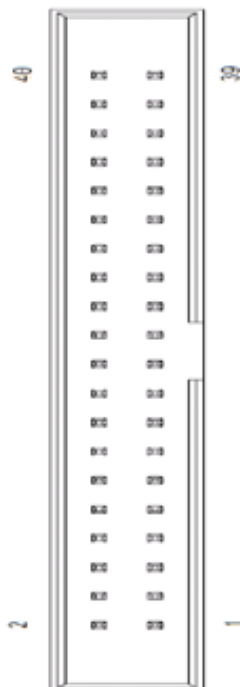

Pin	Signal	Pin	Signal
1	DCD# [3]	2	DSR# [3]
3	RXD [3]	4	RST# [3]
5	TXD [3]	6	CTS# [3]
7	DTR# [3]	8	RI [3]
9	GND	10	GND
11	DCD# [4]	12	DSR# [4]
13	RXD [4]	14	RST# [4]
15	TXD [4]	16	CTS# [4]
17	DTR# [4]	18	RI [4]
19	GND	20	GND
21	DCD# [5]	22	DSR# [5]
23	RXD [5]	24	RST# [5]
25	TXD [5]	26	CTS# [5]
27	DTR# [5]	28	RI [5]
29	GND	30	GND
31	DCD# [6]	32	DSR# [6]
33	RXD [6]	34	RST# [6]
35	TXD [6]	36	CTS# [6]
37	DTR# [6]	38	RI [6]
39	GND	40	GND

## B.28 AT/ATX Mode Selection (PSON1)



Pin	Signal
1	VCCAT
2	+3.3V
3	VCCATX

## B.29 ATX Power Supply(5VSB) Connector (ATX\_5VSB1)



Pin	Signal
1	+V5SB
2	GND
3	PS_ON#

## B.30 COM3 RS232, RS422, and RS485 Selection Pin Header (JSETCOM3)

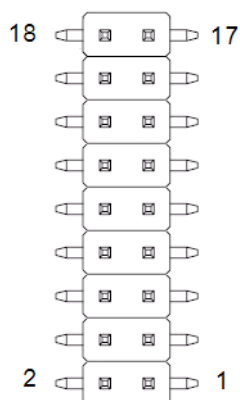

Pin	Signal	Pin	Signal
1	RX	2	RX_485
3	RX	4	RX_422
5	RX	6	RX_232
7	DCD [3]	8	SOUT [3]
9	DCD# [3]	10	COM_SOUT [3]
11	TX_485-	12	RX_485+
13	SIN [3]	14	DTR [3]
15	COM_SIN [3]	16	DTR# [3]
17	TX_485+	18	RX_485-

## B.31 SATA Power Connector (SATA\_PWR1)



Pin	Signal	Pin	Signal
1	+V5	3	GND
2	GND	4	+V12

## B.32 COM2 Pin Header (COM2)

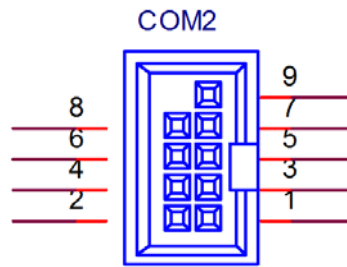

Pin	Signal	Pin	Signal
1	DCD#	2	DSR#
3	SIN	4	RTS#
5	SOUT	6	CTS#
7	DTR#	8	RI#
9	GND		

## B.33 System Fan Connector (SYSFAN1)

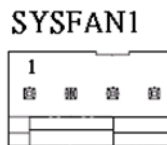

Pin	Signal	Pin	Signal
1	GND	3	FAN SPEED
2	VCC_FAN	4	PWM

## B.34 Case Open Selection Pin Header (JCASEOP\_SW1)



Pin	Signal
1	CASEOP#
2	HWM_CASEOP#
3	CASEOP

## B.35 Case Open Pin Header (JCASE1)

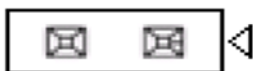

Pin	Signal
1	CASEOP
2	GND

## B.36 PS/2 Keyboard and PS/2 Mouse Connector (KBMS1)

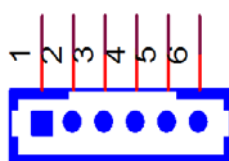

KBMS1

Pin	Signal	Pin	Signal
1	KB_CLK#	4	GND
2	KB_DAT#	5	VCC_KBMS
3	MS_CLK#	6	MS_DAT#

## B.37 Mini-PCle Connector (MINIPCI-E2)

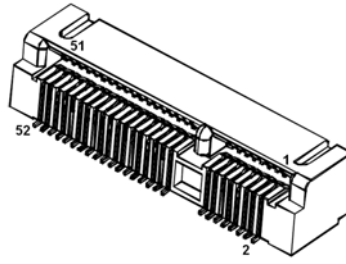

Pin	Signal	Pin	Signal
1	WAKE#	2	+3.3V
3	Reserved	4	GND
5	Reserved	6	+1.5V
7	CLKREQ#	8	SIM_PWR
9	GND	10	SIM_DATA
11	REFCLK-	12	SIM_CLK
13	REFCLK+	14	SIM_RESET
15	GND	16	SIM_VPP
17	Reserved	18	GND
19	Reserved	20	DISABLE#
21	DETECT#	22	RESET#
23	PCIE_RX+	24	+3.3Vaux
25	PCIE_RX-	26	GND
27	GND	28	+1.5V
29	GND	30	SMB_CLK
31	PCIE_TX-	32	SMB_DATA
33	PCIE_TX+	34	GND
35	Reserved	36	USB_D-
37	Reserved	38	USB_D+
39	Reserved	40	GND
41	Reserved	42	Reserved
43	Reserved	44	LED_WLAN#
45	Reserved	46	Reserved
47	Reserved	48	+1.5V
49	Reserved	50	GND
51	Reserved	52	+3.3V

## B.38 Mini-PCle and mSATA Connector (MINIPCI1)

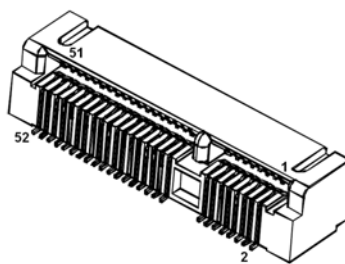

Mini-PCle

Pin	Signal	Pin	Signal
1	WAKE#	2	+3.3Vaux
3	Reserved	4	GND
5	Reserved	6	+1.5 V
7	CLKREQ#	8	Reserved
9	GND	10	Reserved
11	REFCLK-	12	Reserved
13	REFCLK+	14	Reserved
15	GND	16	Reserved
17	Reserved	18	GND
19	Reserved	20	DISABLE#
21	DETECT#	22	RESET#
23	PCIE_RX+	24	+3.3Vaux
25	PCIE_RX-	26	GND
27	GND	28	+1.5V
29	GND	30	SMB_CLK
31	PCIE_TX-	32	SMB_DATA
33	PCIE_TX+	34	GND
35	GND	36	USB_D-
37	GND	38	USB_D+
39	+3.3Vaux	40	GND
41	+3.3Vaux	42	Reserved
43	V1.2_DETECT#	44	LED_WLAN#
45	Reserved	46	Reserved
47	Reserved	48	+1.5 V
49	Reserved	50	GND
51	MSATA_DETECT#	52	+3.3Vaux

## mSATA

Pin	Signal	Pin	Signal
1	Reserved	2	+3.3V
3	Reserved	4	GND
5	Reserved	6	+1.5V
7	Reserved	8	Reserved
9	GND	10	Reserved
11	Reserved	12	Reserved
13	Reserved	14	Reserved
15	GND	16	Reserved
17	Reserved	18	GND
19	Reserved	20	Reserved
21	DETECT#	22	Reserved
23	RX+	24	+3.3V
25	RX-	26	GND
27	GND	28	+1.5V
29	GND	30	SMB_CLK
31	TX-	32	SMB_DATA
33	TX+	34	GND
35	GND	36	Reserved
37	GND	38	Reserved
39	+3.3V	40	GND
41	+3.3V	42	Reserved
43	Reserved	44	Reserved
45	Reserved	46	Reserved
47	Reserved	48	+1.5V
49	Reserved	50	GND
51	MSATA_DETECT#	52	+3.3V

## B.39 Low Pin Count Interface Header (LPC1)

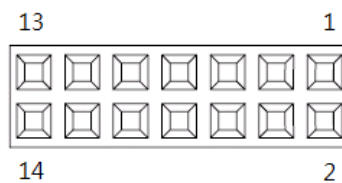

Pin	Signal	Pin	Signal
1	LPC CLK	2	AD1
3	RESET#	4	AD0
5	FRAME#	6	+V3.3
7	AD3	8	GND
9	AD2	10	SMBus CLK
11	SERIRQ	12	SMBus DAT
13	+V5SB	14	+V5



## B.40 BIOS Flash Pin Header (SPI\_CN1)

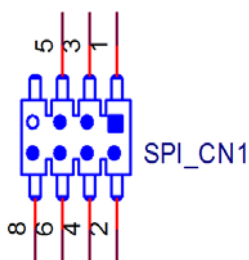

Pin	Signal	Pin	Signal
1	VCC	2	GND
3	SPI_CS#	4	SPI_CLK
5	SPI_MISO	6	SPI_MOSI
		8	N.C

## B.41 RTC Reset Pin Header (JRTCTEST1)

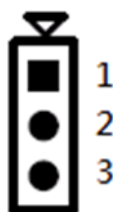

Pin	Signal
1	NC
2	RTC RESET#
3	GND

## B.42 SATA Power Connector (SATA\_PWR2)

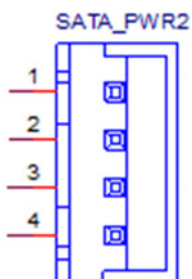

Pin	Signal	Pin	Signal
1	+V5	3	GND
2	GND	4	+V12

## B.43 Dual-Port USB2.0 Pin Header (USB0708)

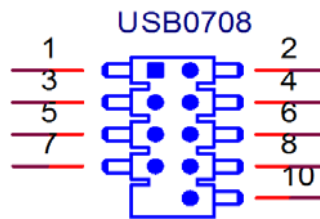

Pin	Signal	Pin	Signal
1	VCC_USB1	2	VCC_USB2
3	USB1-	4	USB2-
5	USB1+	6	USB2+
7	GND	8	GND
9	X	10	N.C

## B.44 eDP Connector (eDP1) (BOM Optional)

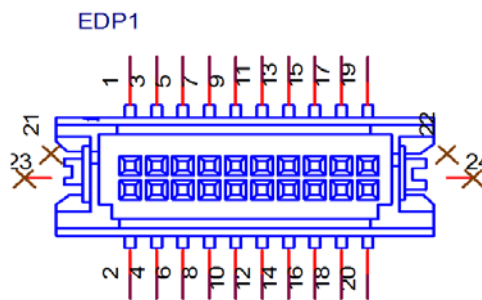

Pin	Signal	Pin	Signal
1	GND	2	GND
3	EDP0-	4	EDP3-
5	EDP0+	6	EDP3+
7	GND	8	N.C
9	EDP1-	10	GND
11	EDP1+	12	EAUX-
13	GND	14	EAUX+
15	EDP2-	16	GND
17	EDP2+	18	DP_HPDP
19	VDD_EDP	20	VDD_EDP

## B.45 Power LED and Keyboard Lock Pin Header (JFP3)



Pin	Signal	Pin	Signal
1	VCC_LED	4	Keyboard LOCK#
2	N.C.	5	GND
3	GNC		

## B.46 Power Switch/HDD LED/SMBus/Speaker Pin Header (JFP1 + JFP2)



Pin	Signal	Pin	Signal
1	+5V	7	SPK_P3
2	HDD LED+	8	SMB_DATA
3	Power Button+	9	System Reset+
4	SPK_P2	10	SPK_P4
5	HDD LED-	11	SMB_CLK
6	Power Button-	12	System Reset-

## B.47 LVDS2 Control Signal Pin Header (LVDS2) (BOM Optional)

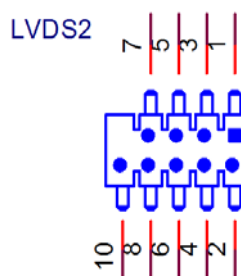

Pin	Signal	Pin	Signal
1	GND	2	+V5
3	LVDS2_BKLTEN	4	LVDS2_GPIO3
5	LVDS2_VDD_EN	6	LVDS2_GPIO2
7	LVDS2_RST#	8	LVDS2_GPIO1
9	X	10	LVDS2_GPIO0

## B.48 eDP Backlight Inverter Power Connector (INV-EDP1) (BOM Optional)

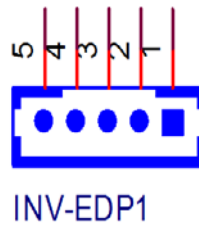

Pin	Signal	Pin	Signal
1	+V12	4	Backlight CTRL
2	GND	5	+V5
3	Backlight EN		

## B.49 ATX 12 V Power Supply Connector (ATX12V1)

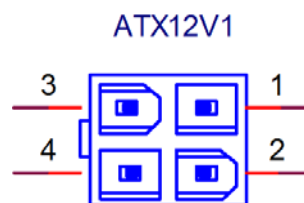

Pin	Signal	Pin	Signal
1	GND	3	VCC
2	GND	4	VCC

## B.50 SIM Card Holder (SIM2)



Pin	Signal	Pin	Signal
1	UIM_PWR	5	GND
2	UIM_RESET	6	UIM_VPP
3	UIM_CLK	7	UIM_DATA
4	Reserved	8	Reserved

## B.51 RS-485/422 Terminal Resistor Jumper (SW\_422\_1)

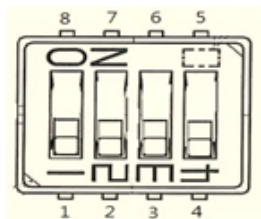

Pin	Signal	Pin	Signal
1	COM3_TXD485P	8	Pull-up terminator (+V5)
2	COM3_TXD485N	7	Pull-down terminator (GND)
3	COM3_RXD422N	6	Pull-down terminator (GND)
4	COM3_RXD422P	5	Pull-up terminator (+V5)

**ADVANTECH**

*Enabling an Intelligent Planet*

**[www.advantech.com](http://www.advantech.com)**

Please verify all specifications before quoting. This guide is intended for reference purposes only.

All product specifications are subject to change without notice.

No part of this publication may be reproduced in any form or by any means, electronic, photocopying, recording or otherwise, without prior written permission from the publisher.

All brand and product names are trademarks or registered trademarks of their respective companies.

© Advantech Co., Ltd. 2014