

Control Technology, I/O Systems and Automation Infrastructure

2015/2016

8





Control technology, I/O systems, and automation infrastructure



Terminal blocks

- Terminal blocks



Surge protection and power supplies

- Surge protection and interference suppression filters
- Power supplies and UPS
- Protective devices



Sensor/actuator cabling and industrial connectors

- Sensor/actuator cabling
- Cables and lines
- Connectors



Interface technology and switching devices

- Electronic switching devices and motor control
- Measurement and control technology
- Monitoring
- Relay modules
- System cabling for controllers



Marking systems, tools, and mounting material

- Marking and labeling
- Tools
- Installation and mounting material

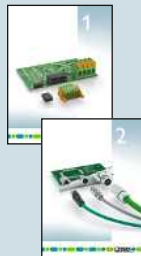

PCB connection technology and electronics housing 2013/14

- PCB terminal blocks and PCB connectors
- Electronics housing



Connection technology for field devices 2013/14

- Connectors
- Cables and lines

Find out more with the web code

On some of the catalog pages, you can find our web codes: a number sign followed by a four-digit number combination.

i Web code: #1234 (example)

This allows you to reach information on our website quickly.

It couldn't be simpler:

1. Go to the Phoenix Contact website
2. Enter # and the number combination in the search field
3. Receive more information and product versions

Or use the direct link:

phoenixcontact.net/webcode/#1234

Information on these products can be found in the electronic product catalogs for 2013/14.

Or get the latest on all the new products and additional information directly in the product area of our website:

phoenixcontact.net/products



Also discover the Phoenix Contact catalog app interactively on your tablet.

Table of contents

Lighting and signaling		5
Functional Safety		23
HMIs and industrial PCs		97
I/O systems		139
Industrial Ethernet		273
Industrial communication technology		331
Process infrastructure		419
Software		435
Controllers		457
Wireless data communication		491
Technical information/index		524



Lighting and signaling

The LED control cabinet lights, LED machine lights, and LED signal towers from Phoenix Contact are the perfect solution for optimally illuminating control cabinets and machinery and clearly signaling machine states.

LED control cabinet lights

Optimum illumination of the control cabinet ensures fast troubleshooting and wiring errors can be avoided. The LED control cabinet lights in the PLD (Phoenix Contact Lighting Devices) product range provide optimum illumination inside your control cabinets right down to the bottom. Thanks to tool-free mounting, the lights can be mounted in no time at all.

With two performance classes and a particularly flexible portfolio, you can choose lights that are tailored to your specific requirements.

LED machine lights

The LED machine lights in the PLD (Phoenix Contact Lighting Devices) product range from Phoenix Contact provide efficient, homogenous, and glare-free illumination of your machinery during startup, maintenance, and interference suppression, as well as during the production process thanks to LED technology and integrated optics. You can easily adjust the brightness to the relevant conditions inside your machine (e.g., reflections) and to the machine states by means of dimming.

Would you like to integrate machine lighting directly in your machine control system? No problem with the communication modules which can be connected upstream.

Signal towers

Early detection of problems affecting machinery and systems is key to reducing downtimes and avoiding any resulting unnecessary costs.

Thanks to the considerable signal diversity of the modular signal towers in the PSD (Phoenix Contact Signaling Devices) product range from Phoenix Contact, you can implement unambiguous signaling of your machine and system states.

Product overview	6
<hr/>	
PLD control cabinet lights	
Class 400 LED control cabinet lights	7
Class 600 LED control cabinet lights	8
<hr/>	
PLD machine lighting	
Communication modules	10
LED machine lights	12
<hr/>	
PSD signal towers	
Optical signal elements	15
Audible signal elements	18
Connection and mounting elements	20

Lighting and signaling

Product overview

PLD control cabinet lights



Class 400 LED control cabinet lights
Page 7



Class 600 LED control cabinet lights
- With motion detector
Page 8



Class 600 LED control cabinet lights
- With motion detector and socket
Page 9

PLD machine lights



Communication modules
for PROFIBUS and PROFINET
Page 10



LED machine lights
Length: 200 mm
Page 12



LED machine lights
Length: 365 mm
Page 13



LED machine lights
Length: 695 mm
Page 13

PSD signal towers



Optical signal element, multicolor
Page 15



Optical signal elements, single-color
Page 16



Audible signal elements
Page 18



Voice output element
Page 19



Connection elements
for surface and tube mounting
Page 20



Mounting elements
for surface and tube mounting
Page 20



Foldaway base
Page 21



Accessories: marking field for towers with
tube mounting
Page 15

Class 400 LED control cabinet lights

new

These LED lights are intended for use inside a control cabinet and provide optimum and efficient illumination right down to the bottom of the cabinet.

Thanks to the various lengths and swivelable light emission window, the lights can be adapted to different control cabinet widths and heights as well as to the depth of the control cabinet plate.

Features:

- Supply voltage: 24 V DC
- Light lengths of 250 mm, 375 mm or 500 mm
- Tool-free mounting using click system
- Optional: magnet or screw fixing as accessories
- Can be connected and controlled in series with M8 cabling with snap-in technology
- Permanent light or automatic mode via upstream door switch
- Mode indicated via status LEDs
- Can be swiveled ($\pm 90^\circ$)
- Highly efficient thanks to LED technology
- LED service life of 50,000 hours (L70 value)
- High color rendering index



Length: 250 mm / 375 mm / 500 mm

Power supply for module electronics

Supply voltage
Power consumption

Light properties

Source of light type
Service life, lighting appliance
Number of LEDs
Color temperature
Color rendering index
Net luminous flux

General data

Connection method
Weight
Protection class
Degree of protection
Width
Height
Length
Mounting position
Ambient temperature (operation)

Technical data

PLD...250	PLD...375	PLD...500
	24 V DC	
2 W	4.2 W	7 W
	LED	
	50,000 h (L70)	
5	12	20
	5000 K	
	75	
140 lm	350 lm	560 lm
	M8 connector (snap-in)	
120 g	170 g	220 g
	III	
	IP20	
	23 mm	
	38 mm	
250 mm	375 mm	500 mm
	any	
	-25 °C ... 60 °C	

Description

LED control cabinet light
- Length: 250 mm
- Length: 375 mm
- Length: 500 mm

Ordering data

Type	Order No.	Pcs. / Pkt.
PLD E 400 W 250	2702221	1
PLD E 400 W 375	2702222	1
PLD E 400 W 500	2702223	1

Class 600 LED control cabinet lights

These LED lights are intended for use inside a control cabinet and provide optimum and efficient illumination right down to the bottom of the cabinet.

Thanks to the integrated motion detector and integrated socket, you can save cabling material and cabling time.

Features:

- AC wide range input
- Tool-free mounting using the integrated snap-in hook system
- Optional: magnet or screw fixing as accessories
- Can be switched in series
- Permanent light or automatic mode via integrated motion detector
- Mode indicated via status LEDs
- Integrated country-specific socket
- Highly efficient thanks to LED technology
- LED service life of 50,000 hours (L70 value)
- High color rendering index



Length: 265 mm

Technical data	
Power supply for module electronics	
Supply voltage range	85 V AC ... 265 V AC (50/60 Hz)
Power consumption	9.8 W
Light properties	
Source of light type	LED
Service life, lighting appliance	50,000 h (L70)
Number of LEDs	23
Color temperature	4000 K
Color rendering index	85
Net luminous flux	685 lm
General data	
Connection method	Installation coupler
Weight	650 g
Protection class	I
Degree of protection	IP20
Width	91 mm
Height	44 mm
Length	265 mm
Mounting position	any
Ambient temperature (operation)	-25 °C ... 60 °C

Description
LED control cabinet light , with motion detector
- Length: 265 mm
LED control cabinet light , with motion detector and socket
- Length: 315 mm, with type F socket (CEE 7/4)
- Length: 315 mm, with type E socket (CEE 7/5)
- Length: 315 mm, with type B socket (NEMA 5-15)

Ordering data		
Type	Order No.	Pcs. / Pkt.
PLD E 608 W 265	2702224	1



new



Length: 315 mm,
type F socket (CEE 7/4)



new



Length: 315 mm,
type E socket (CEE 7/5)



new



Length: 315 mm,
type B socket (NEMA 5-15)

Technical data
85 V AC ... 265 V AC (50/60 Hz) 9.8 W
LED 50,000 h (L70) 23 4000 K 85 685 lm
Installation coupler 770 g I IP20 91 mm 44 mm 315.4 mm any -25 °C ... 60 °C

Technical data
85 V AC ... 265 V AC (50/60 Hz) 9.8 W
LED 50,000 h (L70) 23 4000 K 85 685 lm
Installation coupler 770 g I IP20 91 mm 44 mm 315.4 mm any -25 °C ... 60 °C

Technical data
85 V AC ... 265 V AC (50/60 Hz) 9.8 W
LED 50,000 h (L70) 23 4000 K 85 685 lm
Installation coupler 770 g I IP20 91 mm 44 mm 315.4 mm any -25 °C ... 60 °C

Ordering data		
Type	Order No.	Pcs. / Pkt.
PLD E 608 W 315/F	2702226	1

Ordering data		
Type	Order No.	Pcs. / Pkt.
PLD E 608 W 315/E	2702228	1

Ordering data		
Type	Order No.	Pcs. / Pkt.
PLD E 608 W 315/B	2702227	1

Communication modules

The communication modules enable the direct integration of machine lighting in the machine control system.

This PROFIBUS communication module enables PLD machine lights to be parameterized and controlled directly via a PROFIBUS DP network.

Features:

- PROFIBUS DP slave
- Data transmission speed of 9.6 kbps to 12 Mbps
- PROFIBUS address can be set via two rotary coding switches
- Two PWM outputs for controlling the PLD machine lights
- Adjustable brightness, flashing frequency, and flashing duration
- Specification of the failsafe state for controlled lights
- A digital input for error messages from the controlled lights
- Diagnostic and status indicators
- Resistant to flying chips and sparks
- Resistant to cooling lubricants



PROFIBUS DP

Technical data			
Interface	PROFIBUS DP		
Fieldbus system	M12 connector, B-coded		
Connection method	9.6 kbps ... 12 Mbps		
Transmission speed			
Power supply for module electronics			
Supply voltage	24 V DC		
Supply voltage range	19.2 V DC ... 28.8 V DC		
Digital inputs			
Number of inputs	1 (Error signal from the light(s))		
Description of the inputs	EN 61131-2 type 1		
Nominal input voltage U_{IN}	24 V DC		
Digital outputs			
Number of outputs	2 (PWM signal)		
Output voltage	24 V DC		
Maximum output current per channel	500 mA		
Type of protection	Short-circuit protection, overload protection of the outputs		
General data			
Connection method	M12 connector		
Weight	450 g		
Degree of protection	IP67		
Width	60 mm		
Height	147 mm		
Depth	35 mm		
Note on dimensions	Height without M12 connector		
Mounting position	any		
Ambient temperature (operation)	-25 °C ... 60 °C		
Ordering data			
Description	Type	Order No.	Pcs. / Pkt.
Communication module , for PLD machine lights			
- PROFIBUS DP interface	PLD CM 360 PB	2701695	1

Communication modules

The communication modules enable the direct integration of machine lighting in the machine control system.

This PROFINET communication module enables PLD machine lights to be parameterized and controlled directly via a PROFINET network.

Features:

- PROFINET I/O device
- PROFINET RT
- Two PROFINET ports with integrated switch
- Two PWM outputs for controlling the PLD machine lights
- Adjustable brightness, flashing frequency, and flashing duration
- Specification of the failsafe state for controlled lights
- A digital input for error messages from the controlled lights
- Diagnostic and status indicators
- Resistant to flying chips and sparks
- Resistant to cooling lubricants



PROFINET

Technical data	
Interface	
Fieldbus system	PROFINET
Connection method	M12 connectors, D-coded
Transmission speed	100 Mbps
Power supply for module electronics	
Supply voltage	24 V DC
Supply voltage range	19.2 V DC ... 28.8 V DC
Digital inputs	
Number of inputs	1 (Error signal from the light(s))
Description of the inputs	EN 61131-2 type 1
Nominal input voltage U_N	24 V DC
Digital outputs	
Number of outputs	2 (PWM signal)
Output voltage	24 V DC
Maximum output current per channel	500 mA
Type of protection	Short-circuit protection, overload protection of the outputs
General data	
Connection method	M12 connector
Weight	450 g
Degree of protection	IP67
Width	60 mm
Height	147 mm
Depth	35 mm
Note on dimensions	Height without M12 connector
Mounting position	any
Ambient temperature (operation)	-25 °C ... 60 °C

Ordering data			
Description	Type	Order No.	Pcs. / Pkt.
Communication module , for PLD machine lights			
- PROFINET interface	PLD CM 360 PN	2701696	1

These LED lights are designed for use inside machinery. They provide surface illumination of the interior of the machine.

Features:

- 50° and 100° emission angle
- Light lengths of 200 mm, 365 mm or 695 mm
- Can be connected and controlled in series with M12-SPEEDCON cabling
- Optional control via communication module or I/O station
- Steady light or flashing light
- Can be switched on and off when under no load
- Can be continuously dimmed with PWM signal
- Flashing light control with PWM signal
- Protective functions against polarity reversal, excessively high supply voltage, and overtemperature
- Error indication via digital output
- Resistant to flying chips and sparks
- Resistant to cooling lubricants
- Glare suppression thanks to integrated optics
- Highly efficient thanks to LED technology
- LED service life of 65,000 hours (L70 value)
- High color rendering index



Length 200 mm



Power supply for module electronics	
Supply voltage	24 V DC
Supply voltage range	19.2 V DC ... 28.8 V DC
Current consumption	typ. 0.23 A (at 24 V DC)
Power consumption	typ. 5.5 W
Light properties	
Source of light type	LED
Service life, lighting appliance	65,000 h
Number of LEDs	4
Light color	Neutral white
Color temperature	5000 K ±5 %
Color rendering index	Ra ≥ 80
Illumination	Max. 2090 lx (50 cm distance)
Average illumination	300 lx (1 m x 1 m measuring field with 50 cm distance)
Glare suppression	
Can be dimmed	Thanks to integrated optics Via PWM signal
General data	
Connection method	M12 connector (A-coded)
Weight	500 g
Degree of protection	IP67
Width	60 mm
Height	35 mm
Length	200 mm
Note on dimensions	Length without M12 flush-type connector
Mounting position	any
Ambient temperature (operation)	-25 °C ... 60 °C

Technical data	
PLD M 360 W-50 200	PLD M 360 W-100 200
24 V DC	
19.2 V DC ... 28.8 V DC	
typ. 0.23 A (at 24 V DC)	typ. 0.375 A (at 24 V DC)
typ. 5.5 W	typ. 9 W
LED	
65,000 h	
4	
Neutral white	
5000 K ±5 %	
Ra ≥ 80	
Max. 2090 lx (50 cm distance)	Max. 865 lx (50 cm distance)
300 lx (1 m x 1 m measuring field with 50 cm distance)	
Thanks to integrated optics Via PWM signal	
M12 connector (A-coded)	
500 g	
IP67	
60 mm	
35 mm	
200 mm	
Length without M12 flush-type connector	
any	
-25 °C ... 60 °C	

Description
LED machine light
- 50° emission angle
- 100° emission angle

Ordering data		
Type	Order No.	Pcs. / Pkt.
PLD M 360 W-50 200	2701689	1
PLD M 360 W-100 200	2701692	1



Length 365 mm



Length 695 mm



Technical data

Technical data

PLD M 360 W-50 365	PLD M 360 W-100 365
24 V DC 19.2 V DC ... 28.8 V DC	
typ. 0.46 A (at 24 V DC)	typ. 0.75 A (at 24 V DC)
typ. 11 W	typ. 18 W
LED	
65,000 h	
8	
Neutral white	
5000 K ±5 %	
Ra ≥ 80	
Max. 3630 lx (50 cm distance)	Max. 1675 lx (50 cm distance)
605 lx (1 m x 1 m measuring field with 50 cm distance)	615 lx (1 m x 1 m measuring field with 50 cm distance)
Thanks to integrated optics	
Via PWM signal	
M12 connector (A-coded)	
875 g	
IP67	
60 mm	
35 mm	
365 mm	
Length without M12 flush-type connector	
any	
-25 °C ... 60 °C	

PLD M 360 W-50 695	PLD M 360 W-100 695
24 V DC 19.2 V DC ... 28.8 V DC	
typ. 0.92 A (at 24 V DC)	typ. 1.5 A (at 24 V DC)
typ. 22 W	typ. 36 W
LED	
65,000 h	
16	
Neutral white	
5000 K ±5 %	
Ra ≥ 80	
Max. 4830 lx (50 cm distance)	Max. 2660 lx (50 cm distance)
1160 lx (1 m x 1 m measuring field with 50 cm distance)	1145 lx (1 m x 1 m measuring field with 50 cm distance)
Thanks to integrated optics	
Via PWM signal	
M12 connector (A-coded)	
1630 g	
IP67	
60 mm	
35 mm	
695 mm	
Length without M12 flush-type connector	
any	
-25 °C ... 60 °C	

Ordering data

Ordering data

Type	Order No.	Pcs. / Pkt.
PLD M 360 W-50 365	2701690	1
PLD M 360 W-100 365	2701693	1

Type	Order No.	Pcs. / Pkt.
PLD M 360 W-50 695	2701691	1
PLD M 360 W-100 695	2701694	1

Lighting and signaling

PSD signal towers

Erecting a tower

A signal tower can be erected or extended without using any tools in a matter of seconds by simply placing the individual signal elements on top of each other and turning the bayonet locking system.

This automatically establishes an electrical connection between the elements. The control lines are then connected to screw or spring-cage terminal blocks in the connection element (bottom element).

Optical signal elements

The optical elements are available in a choice of five colors with various different signal types.

Audible signal elements

Signaling can also be supported by an audible element.

Mounting elements

The signal tower portfolio is completed by a wide range of mounting elements, which ensure optimum mounting of the signal towers according to the conditions.

Assemble your signal towers individually as follows:

- ① Select the appropriate mounting method for your application: base or tube mounting.
- ② If applicable, select the mounting bracket or junction box.
- ③ If applicable, select the foot and the required tube length: 110 mm ... 1000 mm.
- ④ Select the appropriate connection element for the mounting type: screw or spring-cage connection.
- ⑤ Select the required optical signal elements and, if applicable, an audible signal element.



Optical signal element – multicolor

With the multicolor element, up to seven colors can be displayed with just one optical element. You can therefore save costs when it comes to storing and controlling signal towers.

The seven colors (red, yellow, green, blue, white, violet, and turquoise) are selected via a maximum of three control lines.

Features:

- Supply voltage: 24 V DC
- 7 colors can be selected
- The colors red, yellow, and green can be selected via just two control lines
- Minimum LED service life of 50,000 h



Permanent light element, multicolor



PSD electrical data

Input voltage	24 V DC
Maximum inrush current	Max. 500 mA
Current consumption	120 mA

General data

Material	Polycarbonate PC
Weight	63 g
Height	65.5 mm
Diameter	70 mm
Degree of protection	IP65, when installed or with cover
Ambient temperature (operation)	-20 °C ... 50 °C
Mounting position	any

Description

LED permanent light element, multicolor
The colors white, red, yellow, green, blue, violet or turquoise can be selected via control signal combination

End cover, black (replacement part)

Marking field for towers with tube mounting, complete with assembly material

Technical data

Input voltage	24 V DC
Maximum inrush current	Max. 500 mA
Current consumption	120 mA

Material	Polycarbonate PC
Weight	63 g
Height	65.5 mm
Diameter	70 mm
Degree of protection	IP65, when installed or with cover
Ambient temperature (operation)	-20 °C ... 50 °C
Mounting position	any

Ordering data

Type	Order No.	Pcs. / Pkt.
PSD-S OE LED MC	2702090	1

Accessories

PSD-S AS END COVER	2700148	1
PSD-S AS LABEL BOARD	2700147	1

Optical signal elements

The optical signal elements enable clear optical indication of the machine or system state.

Features:

- 5 signal types to choose from
- Can be freely combined
- High light and color intensity
- Minimum LED service life of 50,000 h
- All elements for 24 V DC
- Random flashing beacon ensures display cannot be ignored



LED permanent light element



LED blinking light element



Technical data		
...GN / ...CL / ...BU	...RD / ...YE	
PSD electrical data	24 V AC/DC Max. 500 mA	
Input voltage		
Maximum inrush current	25 mA	30 mA
Current consumption		
General data	Polycarbonate PC	
Material	58 g	
Weight	65.5 mm	
Height	70 mm	
Diameter	IP65, when installed or with cover	
Degree of protection	-20 °C ... 50 °C	
Ambient temperature (operation)	any	
Mounting position		

Ordering data		
Type	Order No.	Pcs. / Pkt.
Optical signal elements		
Color: green	PSD-S OE LED GN	2700119
Color: white	PSD-S OE LED CL	2700127
Color: blue	PSD-S OE LED BU	2700131
Color: red	PSD-S OE LED RD	2700107
Color: yellow	PSD-S OE LED YE	2700122

Accessories		
End cover, black (replacement part)	PSD-S AS END COVER	2700148
Marking field for towers with tube mounting, complete with assembly material	PSD-S AS LABEL BOARD	2700147



Technical data		
...GN / ...CL / ...BU	...RD / ...YE	
PSD electrical data	24 V AC/DC Max. 500 mA	
Input voltage		
Maximum inrush current	25 mA	30 mA
Current consumption		
General data	Polycarbonate PC	
Material	59 g	
Weight	65.5 mm	
Height	70 mm	
Diameter	IP65, when installed or with cover	
Degree of protection	-20 °C ... 50 °C	
Ambient temperature (operation)	any	
Mounting position		

Ordering data		
Type	Order No.	Pcs. / Pkt.
Optical signal elements		
Color: green	PSD-S OE LED BL GN	2700121
Color: white	PSD-S OE LED BL CL	2700128
Color: blue	PSD-S OE LED BL BU	2700132
Color: red	PSD-S OE LED BL RD	2700114
Color: yellow	PSD-S OE LED BL YE	2700123

Accessories		
End cover, black (replacement part)	PSD-S AS END COVER	2700148
Marking field for towers with tube mounting, complete with assembly material	PSD-S AS LABEL BOARD	2700147



LED random flashing light element



LED flashing light element



LED rotating light element



Technical data	
...CL / ...BU	...RD / ...YE
24 V DC Max. 500 mA	
250 mA	350 mA
Polycarbonate PC 78 g 65.5 mm 70 mm IP65, when installed or with cover	
-20 °C ... 50 °C any	

Technical data	
24 V DC Max. 200 mA 35 mA	
Polycarbonate PC 72 g 65.5 mm 70 mm IP65, when installed or with cover	
-20 °C ... 50 °C any	

Technical data	
24 V AC/DC Max. 500 mA ≤ 40 mA	
Polycarbonate PC 65 g 65.5 mm 70 mm IP65, when installed or with cover	
-20 °C ... 50 °C any	

Ordering data		
Type	Order No.	Pcs. / Pkt.
PSD-S OE LED RFL CL	2700130	1
PSD-S OE LED RFL BU	2700135	1
PSD-S OE LED RFL RD	2700118	1
PSD-S OE LED RFL YE	2700126	1

Ordering data		
Type	Order No.	Pcs. / Pkt.
PSD-S OE LED FL CL	2700129	1
PSD-S OE LED FL BU	2700134	1
PSD-S OE LED FL RD	2700115	1
PSD-S OE LED FL YE	2700124	1

Ordering data		
Type	Order No.	Pcs. / Pkt.
PSD-S OE LED RL RD	2700116	1
PSD-S OE LED RL YE	2700125	1

Accessories		
PSD-S AS END COVER	2700148	1
PSD-S AS LABEL BOARD	2700147	1

Accessories		
PSD-S AS END COVER	2700148	1
PSD-S AS LABEL BOARD	2700147	1

Accessories		
PSD-S AS END COVER	2700148	1
PSD-S AS LABEL BOARD	2700147	1

Audible signal elements

The audible signal elements enable clear audible indication of the machine or system state.

Features:

- Buzzer and siren elements
- Minimum volume of 80 dB(A)
- Adjustable volume
- Multi-tone siren signaling depending on the situation
- Multilingual signaling thanks to voice output



Buzzer element, continuous/pulse tone



Siren element, alternating



Technical data

Technical data

PSD electrical data	
Input voltage	-
Nominal input voltage range	12 V AC/DC ... 30 V AC/DC
Maximum inrush current	Max. 200 mA
Current consumption	25 mA
Signaling	
Type of acoustic signal	Continuous/pulse tone
Signal frequency	approx. 1 Hz
Tone frequency	approx. 1.75 kHz
Volume	85 dB(A)
General data	
Material	Polycarbonate PC
Weight	73 g
Height	72 mm
Diameter	70 mm
Degree of protection	IP65, when installed
Ambient temperature (operation)	-20 °C ... 50 °C
Electromagnetic compatibility	Conformance with EMC Directive 2004/108/EC
Mounting position	any

PSD electrical data	
Input voltage	24 V DC
Nominal input voltage range	-
Maximum inrush current	Max. 500 mA
Current consumption	150 mA
Signaling	
Type of acoustic signal	Continuous tone, alternating
Signal frequency	-
Tone frequency	approx. 2.5 kHz
Volume	105 dB(A)
General data	
Material	Polycarbonate PC
Weight	106 g
Height	79 mm
Diameter	70 mm
Degree of protection	IP40, when installed
Ambient temperature (operation)	-20 °C ... 50 °C
Electromagnetic compatibility	Conformance with EMC Directive 2004/108/EC
Mounting position	any

PSD electrical data	
Input voltage	24 V DC
Nominal input voltage range	-
Maximum inrush current	Max. 500 mA
Current consumption	150 mA
Signaling	
Type of acoustic signal	Continuous tone, alternating
Signal frequency	-
Tone frequency	approx. 2.5 kHz
Volume	105 dB(A)
General data	
Material	Polycarbonate PC
Weight	106 g
Height	79 mm
Diameter	70 mm
Degree of protection	IP40, when installed
Ambient temperature (operation)	-20 °C ... 50 °C
Electromagnetic compatibility	Conformance with EMC Directive 2004/108/EC
Mounting position	any

Ordering data

Ordering data

Description	
Buzzer element , continuous/pulse tone	
Siren element	
- Alternating	
- Pulse tone, automatic volume control	
- 8 tones, tone selection via DIP switches	
- 7 tones, tone selection via 3 signal cables	
Voice output element , up to 15 sound sequences, maximum play time of 60 minutes	

Type	Order No.	Pcs. / Pkt.
PSD-S AE BM2-1 85DB	2700136	1

Type	Order No.	Pcs. / Pkt.
PSD-S AE SC1-2 105DB	2700139	1



Siren element, pulse tone



Siren element, tones can be selected



Voice output element



Technical data
24 V DC
-
Max. 500 mA
150 mA
Pulse tone, automatic volume control
approx. 1 Hz
approx. 2.5 kHz
-
Polycarbonate PC
122 g
110 mm
71.5 mm
IP65, when installed
-20 °C ... 50 °C
Conformance with EMC Directive 2004/108/EC
any

Technical data	Technical data
PSD-S AE SM8-5 100DB/1	PSD-S AE SM7-4 100DB/3
24 V AC/DC	24 V DC
-	-
Max. 500 mA	80 mA
8 tones, adjustable volume	7 tones, remotely controlled
approx. 1 Hz (Pulse tone)	approx. 1.6 kHz
Max. 100 dB(A) (for continuous and pulse tone of 3.4 kHz)	
Polycarbonate PC	Polycarbonate PC
81 g	80 g
72 mm	70 mm
IP65, when installed	IP65, when installed
-20 °C ... 50 °C	-20 °C ... 50 °C
Conformance with EMC Directive 2004/108/EC	Conformance with EMC Directive 2004/108/EC
any	any

Technical data
24 V DC
-
Max. 3 A (for approximately 2 ms)
< 50 mA (in standby mode)
Voice, max. 15 texts
-
-
approx. 88 dB(A)
Polycarbonate PC
184 g
110 mm
71.5 mm
IP65, when installed
-20 °C ... 50 °C
Conformance with EMC Directive 2004/108/EC
any

Ordering data		
Type	Order No.	Pcs. / Pkt.
PSD-S AE SP1-3 100DB/2	2700137	1

Ordering data		
Type	Order No.	Pcs. / Pkt.
PSD-S AE SM8-5 100DB/1	2700138	1
PSD-S AE SM7-4 100DB/3	2700141	1

Ordering data		
Type	Order No.	Pcs. / Pkt.
PSD-S AE V15/1	2700140	1

Lighting and signaling

PSD signal towers

Connection elements

The cables for controlling the optical and/or audible elements are connected to the connection element. They can either be mounted directly on a surface or on a tube.

The following connection technologies are available:

- Screw terminal blocks
- Spring-cage terminal blocks



For surface mounting



For tube mounting

PSD electrical data	
Nominal input voltage range	12 V AC/DC ... 240 V AC/DC
General data	
Material	PA-GF
Weight	83 g
Height	27 mm
Diameter	69 mm
Degree of protection	IP65, when installed
Ambient temperature (operation)	-20 °C ... 50 °C

Technical data		
12 V AC/DC ... 240 V AC/DC		
PA-GF		
83 g		
27 mm		
69 mm		
IP65, when installed		
-20 °C ... 50 °C		

Technical data		
12 V AC/DC ... 240 V AC/DC		
PA-GF		
84 g		
27 mm		
69 mm		
IP65, when installed		
-20 °C ... 50 °C		

Description	
Connection element	
- With screw connection terminal blocks	
- With spring-cage terminal blocks	

Ordering data		
Type	Order No.	Pcs. / Pkt.
PSD-S CE-SM SCREW	2700093	1
PSD-S CE-SM SPRING	2700091	1

Ordering data		
Type	Order No.	Pcs. / Pkt.
PSD-S CE-TM SCREW	2700095	1
PSD-S CE-TM SPRING	2700092	1

Cable gland , M16 x 1.5 mm, black
--

Accessories		
PSD-S AS CABLE GLAND M16X1,5	2700145	1

Accessories		

Mounting elements for base mounting

For base mounting, the mounting foot of the connection element can be mounted on an outlet box or an angled connector as an option.

The options are as follows:

- Without concealed cable routing
- With concealed cable routing
- Two-sided mounting for up to 10 signal elements



Junction box and bracket



Bracket with concealed cable routing

General data	
Material	PA-GF
Weight	73 g
Ambient temperature (operation)	-30 °C ... 60 °C
Mounting type	Base mounting

Technical data	
PSD-S ME OB	PSD-S ME BR-SM
PA-GF	PA A3 x 2G5
73 g	40 g
-30 °C ... 60 °C	-20 °C ... 50 °C
Base mounting	Base mounting

Technical data	
PSD-S ME BR-SM/1S	PSD-S ME BR-SM/2S
PA A3 x 2G5	PA A3 x 2G5
78 g	71 g
-20 °C ... 60 °C	-20 °C ... 60 °C
Base mounting	Base mounting

Description	
Outlet box with lateral cable entry	
- For base mounting	
Angled connector	
- With visible cable routing	
Angled connector with concealed cable routing	
- For single-sided base mounting	
- For two-sided base mounting	

Ordering data		
Type	Order No.	Pcs. / Pkt.
PSD-S ME OB	2700153	1
PSD-S ME BR-SM	2700144	1

Ordering data		
Type	Order No.	Pcs. / Pkt.
PSD-S ME BR-SM/1S	2700160	1
PSD-S ME BR-SM/2S	2700161	1

Mounting feet and tubes

For tube mounting, the connection element is mounted directly on a tube.

The options are as follows:

- Plastic foot for short tubes
- Metal foot for long tubes
- Foot with integrated tube
- Foldaway base for vertical alignment with angled surfaces
- Adapter for single hole mounting



Adapter and mounting foot with tube



Mounting feet and tubes

Ordering data			
Type	Order No.	Pcs. / Pkt.	
Adapter for single hole mounting	PSD-S ME A-SH M18	2700150	1
Foot with integrated tube - 110 mm long	PSD-S ME BT 110	2700156	1
Foot for tube, Ø 25 mm - Plastic - Metal			
Tube, Ø 25 mm - 250 mm long - 400 mm long - 1000 mm long			
Foldaway base - 7.5° pitch			
Tube, for direct mounting on the foldaway base - 45 mm long			

Ordering data			
Type	Order No.	Pcs. / Pkt.	
PSD-S ME B-P	2700163	1	
PSD-S ME B-M	2700164	1	
PSD-S ME T-M 250	2700157	1	
PSD-S ME T-M 400	2700158	1	
PSD-S ME T-M 1000	2700154	1	
PSD-S ME FB	2700151	1	
PSD-S ME T-P 45	2700152	1	

Mounting elements for tube mounting

For tube mounting, the mounting foot can be mounted on an outlet box or an angled connector as an option.

The options are as follows:

- Without concealed cable routing
- With concealed cable routing
- Magnetic base for tool-free mounting on metal surfaces



Junction boxes



Brackets

Technical data			
PSD-S ME OB	PSD-S ME OB/MB		
Material	PA-GF	PA-GF	
Weight	73 g	299 g	
Ambient temperature (operation)	-30 °C ... 60 °C	-30 °C ... 60 °C	
Mounting type	Base mounting	Base mounting	

Technical data			
PSD-S ME BR-BM/HCR	PSD-S ME BR-BM		
Material	ABS-PC	PA A3 x 2G5	
Weight	80 g	60 g	
Ambient temperature (operation)	-20 °C ... 60 °C	-20 °C ... 50 °C	
Mounting type	Base mounting, concealed cable routing	Base mounting	

Ordering data			
Type	Order No.	Pcs. / Pkt.	
Outlet box with lateral cable entry	PSD-S ME OB	2700153	1
- For base mounting - With magnetic base	PSD-S ME OB/MB	2700155	1
Angled connector			
- With concealed cable routing - With visible cable routing			

Ordering data			
Type	Order No.	Pcs. / Pkt.	
PSD-S ME BR-BM/HCR	2700149	1	
PSD-S ME BR-BM	2700143	1	



Functional Safety

Safety devices

- Modules for all common applications such as emergency stop, safety doors, light grids, etc.
- Modules for monitoring various speeds during operation and downtime
- Modules for coupling digital output signals from failsafe controllers to I/O devices

Configurable safety modules

- Multifunctional evaluation module with 20 safe inputs and 4 safe outputs
- Multifunctional extendable safety module
- Monitoring of all the safety-related functions of a machine, such as emergency stop, safety doors, light grids, etc.
- Flexible extension with safe digital I/O modules
- Easy configuration using the SAFECNF software

Network safety solutions

- SafetyBridge I/O modules exchange safe signals via an automation network
- Flexible use: compatible with all common bus systems
- Easy configuration using the SAFECNF software

Safe control technology

With high-performance safety controllers, proxies, and gateways, you can also reliably integrate Functional Safety into your PROFIsafe networks.

- Controls even large numbers of I/Os reliably, thanks to high-performance technology
- Reduced wiring effort, thanks to the joint transmission of control and safety protocols via a single Ethernet cable
- Uniform configuration worldwide, thanks to standardized programming according to IEC 61131

Product overview	24
Selection guide for safety switching devices and modules	26
Safety switching devices for machine building	
Safety relays - PSRmini	31
Safety relays - PSRclassic	40
Modular safety relay system - PSRmodular	50
Multifunctional safety relays - PSRmultifunction	56
Applications	58
Safety switching devices for speed and downtime monitoring	
Speed and downtime monitors - PSRmotion	62
Safety switching devices – forcibly guided coupling relays	
Forcibly guided coupling relays - PSRclassic	63
Safety switching devices for the process industry	
Safe coupling relays - PSRmini	66
Safe coupling relays - PSRclassic	72
Termination carriers for PSRmini and PSRclassic	75
Applications	76
Configurable safety modules	
TRISAFE-S	78
TRISAFE-M	79
TRISAFE extension modules	80
Network safety solutions	
Logic modules	82
Safe I/O modules	83
Software	
SAFECNF	88
PSR-CONF-WIN	89
SAFETYPROG	90
Safe analog value processing	91
Safe control technology	
Safe PROFINET gateway	92
Safe PROFIsafe controller	93
Services for Functional Safety	94

Safety switching devices for machine building – safety relays



PSRmini – highly compact safety relays for all common applications
Page 31



PSRclassic – safety relays for all common applications, with time function, extension modules
Page 40



PSRmodular – modular safety relay system with DIN rail connector
Page 50



PSRmultifunction – safety relay for three safety functions in a single device
Page 56

Speed and downtime monitors



PSRmotion – speed and downtime monitors that can be parameterized via software
Page 62

Positively driven coupling relays



PSRclassic – forcibly guided coupling relays
Page 63

Safety switching devices for the process industry – safe coupling relays



PSRmini – highly compact, safe coupling relays for failsafe controllers and F&G applications
Page 67



PSRclassic – safe coupling relays for failsafe controllers
Page 72



PSRclassic – termination carriers for the alignment and easy mounting of coupling relays
Page 75



PSRmini – termination carriers for the alignment and easy mounting of highly compact coupling relays
Further information:
phoenixcontact.net/products

Configurable safety modules



TRISAFE-S – master module, cannot be extended
Page 78



TRISAFE-M – master module that can be safely extended
Page 79



TRISAFE – extension modules
Page 80

Network safety solutions



Logic modules for safe signal exchange using a SafetyBridge system

Page 82



Safe I/O modules for safe signal exchange in popular networks

Page 83



Safe I/O modules – output module with relay outputs

Page 84



Safe I/O modules for safe signal exchange in popular networks

Page 86

Software



SAFECONF – configuration software for TRISAFE and SafetyBridge modules

Page 88



PSR-CONF-WIN – configuration software for PSR-RSM4 with connecting cable

Page 89



SafetyProg – programming software for INTERBUS-Safety systems and PROFIsafe controllers

Page 90

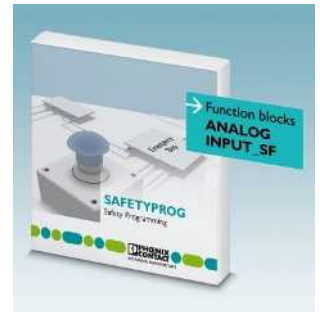

SafetyProg – function blocks for safe analog value processing

Page 91

Safe control technology



Safe PROFINET gateway

Page 92



Safe PROFIsafe controller

Page 93

Safe signal conditioners



• See Catalog 7 – Interface technology and switching devices

Services for Functional Safety



Consultation and presentation

Individual consultation and on-site process assistance

Page 94



Engineering

Support with the implementation of safety requirements

Page 94



Product support

Free 24-hour safety hotline, on-site service, workshops, concept support

Page 94















Seminars and workshops

Theoretical and practical know-how for machine safety

Page 94

Safety switching devices for machine building (safety relays)

Type	Supply voltage	Application							Output contacts			Safety approval		Page	
															PL according to EN ISO 13849-1
PSRmini	PSR-MS20	24 V DC	X	X	-	X	-	-	A	1	-	1DO	c ¹⁾	1 ¹⁾	31
	PSR-MS25	24 V DC	X	X	-	X	-	-	M	1	-	1DO	c ¹⁾	1 ¹⁾	31
	PSR-MS30	24 V DC	X	X	-	X	-	X	A	1	-	-	e	3	32
	PSR-MS35	24 V DC	X	X	-	X	-	X	M	1	-	-	e	3	32
	PSR-MS40	24 V DC	X	X	-	-	-	X	A	1	-	1DO	e	3	33
	PSR-MS45	24 V DC	X	X	-	-	-	X	M	1	-	1DO	e	3	33
	PSR-MS50	24 V DC	-	X	-	X	-	-	A	1	-	1DO	e	3	34
	PSR-MS55	24 V DC	-	X	-	X	-	-	M	1	-	1DO	e	3	34
	PSR-MS60	24 V DC	X	X	X	X	-	X	A	2	-	-	e	3	35
	PSR-MC20	24 V DC	X	X	-	X	-	-	A/M	3	-	1DO	c ¹⁾	1 ¹⁾	36
	PSR-MC30	24 V DC	X	X	-	X	-	X	A/M	2	-	1DO	e	3	37
	PSR-MC34	24 V DC	X	X	-	X	-	X	A/M	3	-	1DO	e	3	37
	PSR-MC40	24 V DC	X	X	X	X	-	X	A/M	3	-	1DO	e	3	38
	PSR-MC50	24 V DC	-	X	-	X	-	-	A/M	3	-	1DO	e	3	39
PSRclassic	PSR-ESA2-B	24 V AC/DC	X	X	-	-	-	-	A	4	-	1	c ¹⁾	1 ¹⁾	40
	PSR-ESAM2/3X1-B	230 V AC	X	X	-	-	-	-	A/M	3	-	1	c ¹⁾	1 ¹⁾	40
	PSR-ESAM4/2X1	24 V AC/DC	X	X	-	-	-	-	A/M	2	-	1	e	3	41
	PSR-ESAM4/3X1-B	24 V AC/DC	X	X	-	-	-	-	A/M	3	-	1	e	3	42
	PSR-ESAM4/3X1-B	Various voltages	X	X	-	-	-	-	A/M	3	-	1	e	3	42
	PSR-ESAM4/3X1	24...230 V AC/DC	X	X	-	-	-	-	A/M	3	-	1	e	3	43
	PSR-ESAM4/8X1	24 V AC/DC	X	X	-	-	-	-	A/M	8	-	1	e	3	43
	PSR-ESD-30	24 V DC	X	X	X	-	-	X	A/M	2	2	1	e ²⁾	3 ²⁾	44
	PSR-ESD-300	24 V DC	X	X	X	-	-	X	A/M	3	2	1	e ²⁾	3 ²⁾	44
	PSR-ESD-T	24 V DC	X	X	X	-	-	X	A/M	3	2	1	e ²⁾	3 ²⁾	45
	PSR-ESL4	24 V AC/DC	X	X	X	-	-	X	A/M	3	-	1	e	3	46
	PSR-THC4	24 V AC/DC	-	X	-	-	X	-	A	2	-	1	e	3	47
	PSR-URML4	24 V DC	Contact extension for OSSD signals							3	-	1	e	3	49
	PSR-URM4	24 V AC/DC	Contact extension							5	-	2	e ⁴⁾	3 ⁴⁾	48
	PSR-URM4-B	24 V AC/DC	Contact extension							5	-	2	e ⁴⁾	3 ⁴⁾	49
PSR-URM4	42...230 V AC/DC	Contact extension							4	-	2	e ⁴⁾	3 ⁴⁾	49	

1) Depending on the application up to PL e/SILCL 3 possible

2) Undelayed contacts; Cat.4/PL e, SILCL 3; dropout delayed contacts; Cat.3/PL d, SILCL 2;

3) Type IIIC according to EN 574













4) In conjunction with suitable evaluating device

5) Delayed

A = Automatic start





M = Manual, monitored start

Safety switching devices for machine building (safety relays)



Type	Supply voltage	Application							Output contacts			Safety approval		Page	
															
PSRmodular	PSR-SDC4	24 V DC	X	X	X	X	-	X	A/M	2	-	-	e	3	51
	PSR-URM4/B	24 V DC	Contact extension							4	-	2	e	3	51
	PSR-URD3/3	24 V DC	Contact extension							-	4	2 ⁵⁾	d	2	51
	PSR-URD3/30	24 V DC	Contact extension							-	4	2 ⁵⁾	d	2	52
	PSR-URD3/T2	24 V DC	Contact extension							-	4	2 ⁵⁾	d	2	52
	PSR-SIM4		Interface module										e	3	53
PSRmultifunction	PSR-MXF1	24 V DC	X	X	-	-	-	-	A/M	4	-	2	e	3	56
	PSR-MXF2	24 V DC	X	-	-	X	-	-	A/M	4	-	2	e	3	56
	PSR-MXF3	24 V DC	X	X	X	-	-	X	A/M	4	-	2	e	3	56
	PSR-MXF4	24 V DC	X	-	X	X	-	X	A/M	4	-	2	e	3	56

1) Depending on the application up to PL e/SILCL 3 possible
 2) Undelayed contacts; Cat.4/PL e, SILCL 3; dropout delayed contacts; Cat.3/PL d, SILCL 2;
 3) Type IIIC according to EN 574
 4) In conjunction with suitable evaluating device
 5) Delayed
 A = Automatic start
 M = Manual, monitored start



Safety switching devices for speed and downtime monitoring

Type	Supply voltage	Application		Output contacts		Safety approval			Page	
						Cat. according to EN ISO 13849-1	PL according to EN ISO 13849-1	SILCL according to EN 62061		
PSRmotion	PSR-RSM4	24 V DC	X	X	4	3DO	4	e	3	62

Safety switching devices – forcibly guided coupling relays

Type	Supply voltage	Application	Output contacts			Page	
							
PSRclassic	PSR-URM	24 V AC/DC 120 V AC/DC	Forcibly guided coupling relays	5	2	-	63
	PSR-URM/5X1	24 V AC/DC		5	1	-	64
	PSR-URM/3X1	24 V AC/DC		3	3	-	64
	PSR-URM/4X1	24 V AC/DC 120 V AC/DC		4	2	-	65
	PSR-URM/2X21	24 V AC/DC 120 V AC/DC		-	-	2	65

Safety switching devices for the process industry (safe coupling relays)

Type	Supply voltage	Application	Output contacts		Diagnostics/ Proof test				Safety approval				Page		
					Visual via LED	Active error acknowledgment via A1	Measurement on the device	Self-regulation with integrated lock	SIL according to IEC 61508/61511	SIL according to IEC 50156	ATEX/IECEX/Class I Zone 2	G3 according to ANSI/ISA-S71.04		GL	
PSRmini	PSR-PS20	24 V DC	Highly compact, safe coupling relays for failsafe controllers for safety-related switching off (ESD)	1	1NC/ 1DO	X	X	X	-	3	3	X	X	X	67
	PSR-PS21	24 V DC		1	1NC/ 1DO	X	X	X	-	2	2	X	X	X	68
	PSR-PS40	24 V DC		1	1DO	X	-	-	X	3	3	X	X	X	68
	PSR-PC20	24 V DC		1	1NC/ 1DO	X	X	X	-	3	3	X	X	X	69
	PSR-PC40	24 V DC		2	1DO	X	X	-	X	3	3	X	X	X	70
	PSR-PC50	24 V DC	Highly compact, safe coupling relay for failsafe controllers for safety-related switch on (F&G)	1	1DO	-	X	X	-	3 ¹⁾	-	X	-	X	71
PSRclassic	PSR-FSP	24 V DC	Highly compact, safe coupling relays for failsafe controllers for safety-related switching off (ESD)	1	1NC	-	-	X	-	3	3	-	-	X	72
	PSR-FSP/2X1	24 V DC		2	1NC	-	-	X	-	3	3	-	-	X	73
	PSR-FSP2/2X1	24 V DC		2	1NC			X		2	2	-	-	X	73
	PSR-ESP4	24 V DC		2	1NC	-	-	-	X	3	-	-	-	X	74

¹⁾ Low demand

Configurable safety modules

Type		Supply voltage	Application	Inputs/outputs					Safety approval			Page
				Inputs	Safe control outputs	Grounded switching outputs	Clock outputs	Signal outputs	Category according to EN ISO 13849-1	PL according to EN ISO 13849-1	SILCL according to EN 62061	
TRISAFE	TRISAFE-S	24 V DC	Master module (not extendable)	20	4	2	2	4	4	e	3	78
	TRISAFE-M	24 V DC	Master module (extendable)	20	4	2	2	4	4	e	3	79
	TS-SDIO	24 V DC	Safe digital I/O extension module	8	4 ¹⁾	-	2 ¹⁾	2 ¹⁾	4	e	3	80
	TS-SDOR	24 V DC	Safe extension module with relay outputs	-	4 ³⁾	-	-	4	4 ²⁾	e ²⁾	3 ²⁾	80

¹⁾ Configurable via software: outputs to inputs/alarm outputs to clock outputs

²⁾ Depending on connection, up to ...

³⁾ Configurable via software: 4 x 1-channel or 2 x 2-channel

Network safety solutions

Type		Supply voltage	Application	Inputs/outputs			Protocol		Safety approval			Page
				Safe inputs	Safe outputs	Clock outputs	SafetyBridge technology	PROFIsafe	Category according to EN ISO 13849-1	PL according to EN ISO 13849-1	SILCL according to EN 62061	
Logic modules	IB IL 24 LPSDO 8 V2-PAC	24 V DC	Logic module with SafetyBridgeTechnology V2	-	8	-	X	-	4	e	3	82
	IB IL 24 LPSDO 8 V3-PAC	24 V DC	Logic module with SafetyBridgeTechnology V3	-	8	-	X	-	4	e	3	82
Safe I/O modules	IB IL 24 PSDI 8-PAC	24 V DC	Input module	8	-	8	X	X	4	e	3	83
	IB IL 24 PSDI 16-PAC	24 V DC	Input module ¹⁾	16	-	16	X	X	4	e	3	83
	IB IL 24 PSDO 8-PAC	24 V DC	Output module	-	8	-	X	X	4	e	3	84
	IB IL 24 PSDO 4/4-PAC	24 V DC	Output module (positive and negative switching)	-	4	-	X	X	4	e	3	85
	IB IL 24 PSDOR 4-PAC	24 V DC/230 V DC	Output module with relay outputs	-	4 ¹⁾	-	X	X	4	e	3	85
	AXL F PSDI8/4 1F	24 V DC	Input module	8	-	8	-	X	4	e	3	86
	AXL F PSDO8/3 1F	24 V DC	Output module	-	8	-	-	X	4	e	3	87

¹⁾ Only compatible with IB IL 24 LPSDO V3-PAC

²⁾ Relay outputs

Safety relays



Our PSR safety relays demonstrate that innovative safety solutions do not necessarily have to be complex in order to meet the high requirements of machine building and systems manufacturing.

As well as offering easy integration and handling, the modules are characterized by their compact, space-saving design as well as their high quality, safety, and reliability.

In particular, safety applications can be implemented under optimal cost-benefit conditions with the new PSRmini safety relay range.

PSR safety relays offer you solutions for all common applications such as monitoring the following protective tasks:

- Emergency stop
- Safety door
- Light grid
- Solenoid switch
- Two-hand control devices
- Enable switch

Convenient connection technology

The majority of PSR safety relays are available with plug-in screw or spring-cage connection technology. The TWIN spring-cage connectors provide enough space for two cables per terminal point.

Quick extension

The modular safety systems allow additional extension modules to be integrated easily using the PSR-TBUS DIN rail connector. As a result, there is no longer any need to install cross-wiring for additional output contacts.

Numerous approvals

PSR safety relays conform to all applicable safety standards such as EN ISO 13849-1 and IEC 62061. In addition, modules with GL approval or certification according to EN 50156 are also available.

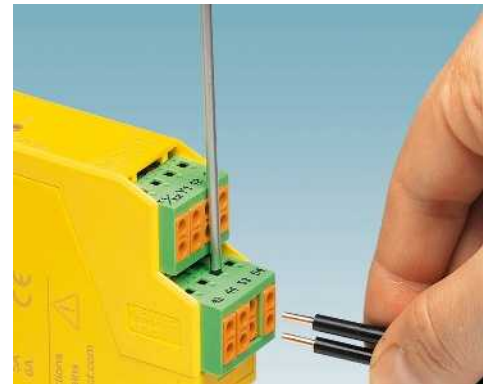

User-friendly connection technology



Quick extension



Numerous approvals

Highly compact safety relays for emergency stop and safety door monitoring

- Single-channel control
- 1 enabling current path, 1 digital signal output
- Basic insulation/reinforced insulation in part
- Activation depending on type: automatic or manual, monitored
- Cat. 1/PL c according to EN ISO 13849-1, SILCL 1 according to IEC 62061
- Depending on the application up to Cat. 4/PL e according to EN ISO 13849-1, SILCL 3 according to IEC 62061

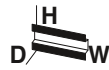

Automatic activation

new



Manual and monitored activation

new

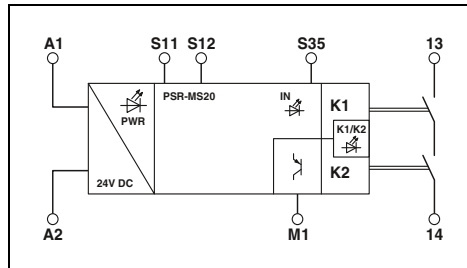

Technical data

Input data	24 V DC -15 % / +10 %
Rated control supply voltage U_s	typ. 42 mA
Rated control supply current I_s	< 175 ms
Typical response time	< 20 ms (when controlled via A1 or S12)
Typical release time	< 500 ms
Recovery time	1 enabling current path
Output data	AgSnO ₂
Contact type	250 V AC/DC / 20 V AC/DC
Contact material	6 A (N/O contact)
Max./min. switching voltage	6 A / 3 mA
Limiting continuous current	60 mW
Max./min. inrush current	6 A gL/gG (N/O contact), 4 A gL/gG (for low-demand applications)
Min. switching power	60 mW
Short-circuit protection of the output circuits	6 A gL/gG (N/O contact), 4 A gL/gG (for low-demand applications)
Alarm outputs	1 (digital, PNP)
Number of outputs	Max. 100 mA
Output current	no
Short-circuit protection	no
General data	-40 °C ... 60 °C (observe derating)
Ambient temperature range	DIN EN 50178
Air and creepage distances between the circuits	Safe isolation, reinforced insulation 6 kV between input circuit and enabling current path
Rated surge voltage/insulation	Basic insulation 4 kV between all current paths and housing
Screw connection solid / stranded / AWG	0.2 - 2.5 mm ² / 0.2 - 2.5 mm ² / 26 - 12
Dimensions	6.8 mm / 93.1 mm / 102.5 mm

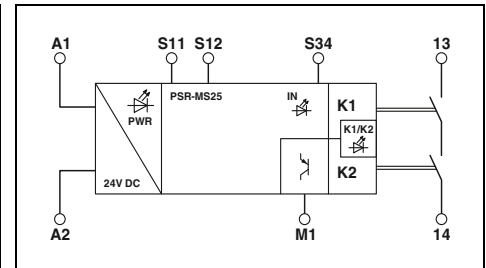

Technical data

Input data	24 V DC -15 % / +10 %
Rated control supply voltage U_s	typ. 42 mA
Rated control supply current I_s	< 175 ms
Typical response time	< 20 ms (when controlled via A1 or S12)
Typical release time	< 500 ms
Recovery time	1 enabling current path
Output data	AgSnO ₂
Contact type	250 V AC/DC / 20 V AC/DC
Contact material	6 A (N/O contact)
Max./min. switching voltage	6 A / 3 mA
Limiting continuous current	60 mW
Max./min. inrush current	6 A gL/gG (N/O contact), 4 A gL/gG (for low-demand applications)
Min. switching power	60 mW
Short-circuit protection of the output circuits	6 A gL/gG (N/O contact), 4 A gL/gG (for low-demand applications)
Alarm outputs	1 (digital, PNP)
Number of outputs	Max. 100 mA
Output current	no
Short-circuit protection	no
General data	-40 °C ... 60 °C (observe derating)
Ambient temperature range	DIN EN 50178
Air and creepage distances between the circuits	Safe isolation, reinforced insulation 6 kV between input circuit and enabling current path
Rated surge voltage/insulation	Basic insulation 4 kV between all current paths and housing
Screw connection solid / stranded / AWG	0.2 - 2.5 mm ² / 0.2 - 2.5 mm ² / 26 - 12
Dimensions	6.8 mm / 93.1 mm / 102.5 mm

Ordering data

Description	Type	Order No.	Pcs. / Pkt.
Emergency stop and safety door monitoring	PSR-MS20-1NO-1DO-24DC-SC	2904950	1

Ordering data

Description	Type	Order No.	Pcs. / Pkt.
Emergency stop and safety door monitoring	PSR-MS25-1NO-1DO-24DC-SC	2904951	1

Functional Safety

Safety switching devices for machine building – PSRmini

Highly compact safety relays for emergency stop and safety door monitoring

- Two-channel control
- 1 enabling current path
- Basic insulation/reinforced insulation in part
- Cross-circuit detection
- Activation depending on type: automatic or manual, monitored
- Up to Cat. 4/PL e according to EN ISO 13849-1, SILCL 3 according to IEC EN 62061



Automatic activation

new



Manual and monitored activation

new

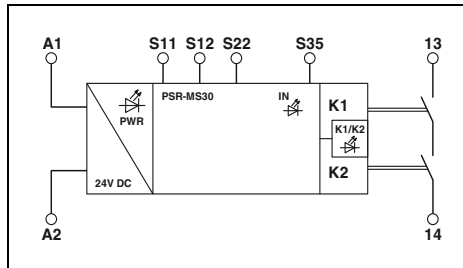

Technical data

Input data	
Rated control supply voltage U_s	24 V DC -15 % / +10 %
Rated control supply current I_s	typ. 42 mA
Typical response time	< 175 ms
Typical release time	< 20 ms (when controlled via A1 or S12 and S22)
Recovery time	< 500 ms
Output data	
Contact type	1 enabling current path
Contact material	AgSnO ₂
Max./min. switching voltage	250 V AC/DC / 20 V AC/DC
Limiting continuous current	6 A (N/O contact)
Max./min. inrush current	6 A / 3 mA
Min. switching power	60 mW
Short-circuit protection of the output circuits	6 A gL/gG (N/O contact), 4 A gL/gG (for low-demand applications)
General data	
Ambient temperature range	-40 °C ... 60 °C (observe derating)
Air and creepage distances between the circuits	DIN EN 50178
Rated surge voltage/insulation	Safe isolation, reinforced insulation 6 kV between input circuit and enabling current path Basic insulation 4 kV between all current paths and housing
Screw connection solid / stranded / AWG	0.2 - 2.5 mm ² / 0.2 - 2.5 mm ² / 26 - 12
Dimensions	6.8 mm / 93.1 mm / 102.5 mm

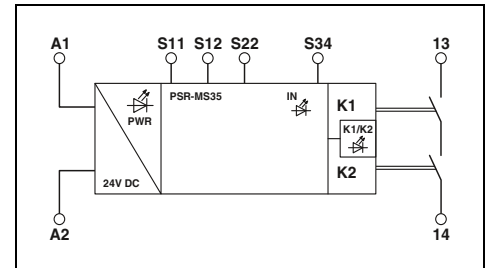

Technical data

Input data	
Rated control supply voltage U_s	24 V DC -15 % / +10 %
Rated control supply current I_s	typ. 42 mA
Typical response time	< 175 ms
Typical release time	< 20 ms (when controlled via A1 or S12 and S22)
Recovery time	< 500 ms
Output data	
Contact type	1 enabling current path
Contact material	AgSnO ₂
Max./min. switching voltage	250 V AC/DC / 20 V AC/DC
Limiting continuous current	6 A (N/O contact)
Max./min. inrush current	6 A / 3 mA
Min. switching power	60 mW
Short-circuit protection of the output circuits	6 A gL/gG (N/O contact), 4 A gL/gG (for low-demand applications)
General data	
Ambient temperature range	-40 °C ... 60 °C (observe derating)
Air and creepage distances between the circuits	DIN EN 50178
Rated surge voltage/insulation	Safe isolation, reinforced insulation 6 kV between input circuit and enabling current path Basic insulation 4 kV between all current paths and housing
Screw connection solid / stranded / AWG	0.2 - 2.5 mm ² / 0.2 - 2.5 mm ² / 26 - 12
Dimensions	6.8 mm / 93.1 mm / 102.5 mm

Ordering data

Description	Type	Order No.	Pcs. / Pkt.
Emergency stop and safety door monitoring	PSR-MS30-1NO-24DC-SC	2904952	1

Ordering data

Description	Type	Order No.	Pcs. / Pkt.
Emergency stop and safety door monitoring	PSR-MS35-1NO-24DC-SC	2904953	1

Highly compact safety relays for emergency stop and safety door monitoring

- Two-channel control
- 1 enabling current path, 1 digital signal output
- Basic insulation/reinforced insulation in part
- Activation depending on type: automatic or manual, monitored
- Up to Cat. 4/PL e according to EN ISO 13849-1, SILCL 3 according to IEC EN 62061



Automatic activation

new



Manual and monitored activation

new

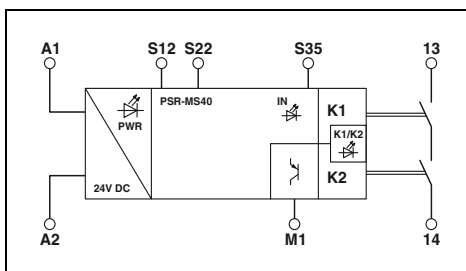

Technical data

Input data	
Rated control supply voltage U_s	24 V DC -15 % / +10 %
Rated control supply current I_s	typ. 42 mA
Typical response time	< 175 ms
Typical release time	< 20 ms (when controlled via A1 or S12 and S22)
Recovery time	
	< 500 ms
Output data	
Contact type	1 enabling current path
Contact material	AgSnO ₂
Max./min. switching voltage	250 V AC/DC / 20 V AC/DC
Limiting continuous current	6 A (N/O contact)
Max./min. inrush current	6 A / 3 mA
Min. switching power	60 mW
Short-circuit protection of the output circuits	6 A gL/gG (N/O contact), 4 A gL/gG (for low-demand applications)
Alarm outputs	
Number of outputs	1 (digital, PNP)
Output current	Max. 100 mA
Short-circuit protection	no
General data	
Ambient temperature range	-40 °C ... 60 °C (observe derating)
Air and creepage distances between the circuits	DIN EN 50178
Rated surge voltage/insulation	Safe isolation, reinforced insulation 6 kV between input circuit and enabling current path Basic insulation 4 kV between all current paths and housing
Screw connection solid / stranded / AWG	0.2 - 2.5 mm ² / 0.2 - 2.5 mm ² / 26 - 12
Dimensions	6.8 mm / 93.1 mm / 102.5 mm

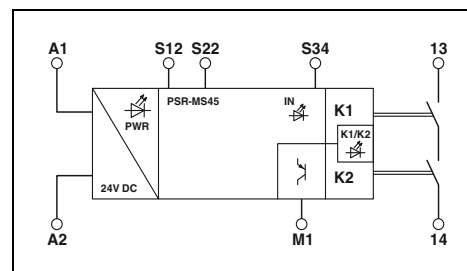

Technical data

Input data	
Rated control supply voltage U_s	24 V DC -15 % / +10 %
Rated control supply current I_s	typ. 42 mA
Typical response time	< 175 ms
Typical release time	< 20 ms (when controlled via A1 or S12 and S22)
Recovery time	
	< 500 ms
Output data	
Contact type	1 enabling current path
Contact material	AgSnO ₂
Max./min. switching voltage	250 V AC/DC / 20 V AC/DC
Limiting continuous current	6 A (N/O contact)
Max./min. inrush current	6 A / 3 mA
Min. switching power	60 mW
Short-circuit protection of the output circuits	6 A gL/gG (N/O contact), 4 A gL/gG (for low-demand applications)
Alarm outputs	
Number of outputs	1 (digital, PNP)
Output current	Max. 100 mA
Short-circuit protection	no
General data	
Ambient temperature range	-40 °C ... 60 °C (observe derating)
Air and creepage distances between the circuits	DIN EN 50178
Rated surge voltage/insulation	Safe isolation, reinforced insulation 6 kV between input circuit and enabling current path Basic insulation 4 kV between all current paths and housing
Screw connection solid / stranded / AWG	0.2 - 2.5 mm ² / 0.2 - 2.5 mm ² / 26 - 12
Dimensions	6.8 mm / 93.1 mm / 102.5 mm

Ordering data

Description	Emergency stop and safety door monitoring
-------------	--

Type	Order No.	Pcs. / Pkt.
PSR-MS40-1NO-1DO-24DC-SC	2904954	1

Ordering data

Type	Order No.	Pcs. / Pkt.
PSR-MS45-1NO-1DO-24DC-SC	2904955	1

Functional Safety

Safety switching devices for machine building – PSRmini

Highly compact safety relays for monitoring non-equivalent signal generators

- Two-channel non-equivalent control
- 1 enabling current path, 1 digital signal output
- Basic insulation/reinforced insulation in part
- Activation depending on type: automatic or manual, monitored
- Up to Cat. 4/PL e according to EN ISO 13849-1, SILCL 3 according to IEC EN 62061



new

Automatic activation



new

Manual and monitored activation

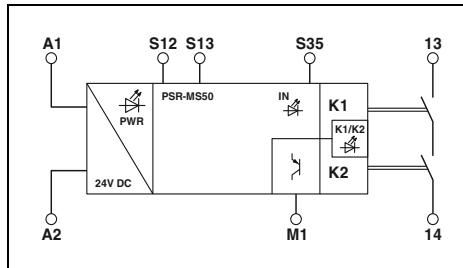

Technical data

Input data	
Rated control supply voltage U_s	24 V DC -15 % / +10 %
Rated control supply current I_s	typ. 42 mA
Typical response time	< 175 ms
Typical release time	< 20 ms (when controlled via A1 or S12 and S13)
Recovery time	< 500 ms
Output data	
Contact type	1 enabling current path
Contact material	AgSnO ₂
Max./min. switching voltage	250 V AC/DC / 20 V AC/DC
Limiting continuous current	6 A (N/O contact)
Max./min. inrush current	6 A / 3 mA
Min. switching power	60 mW
Short-circuit protection of the output circuits	6 A gL/gG (N/O contact), 4 A gL/gG (for low-demand applications)
Alarm outputs	
Number of outputs	1 (digital, PNP)
Output current	Max. 100 mA
Short-circuit protection	no
General data	
Ambient temperature range	-40 °C ... 60 °C (observe derating)
Air and creepage distances between the circuits	DIN EN 50178
Rated surge voltage/insulation	Safe isolation, reinforced insulation 6 kV between input circuit and enabling current path Basic insulation 4 kV between all current paths and housing
Screw connection solid / stranded / AWG	0.2 - 2.5 mm ² / 0.2 - 2.5 mm ² / 26 - 12
Dimensions	6.8 mm / 93.1 mm / 102.5 mm

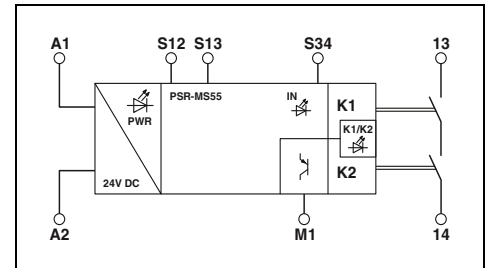

Technical data

Input data	
Rated control supply voltage U_s	24 V DC -15 % / +10 %
Rated control supply current I_s	typ. 42 mA
Typical response time	< 175 ms
Typical release time	< 20 ms (when controlled via A1 or S12 and S13)
Recovery time	< 500 ms
Output data	
Contact type	1 enabling current path
Contact material	AgSnO ₂
Max./min. switching voltage	250 V AC/DC / 20 V AC/DC
Limiting continuous current	6 A (N/O contact)
Max./min. inrush current	6 A / 3 mA
Min. switching power	60 mW
Short-circuit protection of the output circuits	6 A gL/gG (N/O contact), 4 A gL/gG (for low-demand applications)
Alarm outputs	
Number of outputs	1 (digital, PNP)
Output current	Max. 100 mA
Short-circuit protection	no
General data	
Ambient temperature range	-40 °C ... 60 °C (observe derating)
Air and creepage distances between the circuits	DIN EN 50178
Rated surge voltage/insulation	Safe isolation, reinforced insulation 6 kV between input circuit and enabling current path Basic insulation 4 kV between all current paths and housing
Screw connection solid / stranded / AWG	0.2 - 2.5 mm ² / 0.2 - 2.5 mm ² / 26 - 12
Dimensions	6.8 mm / 93.1 mm / 102.5 mm

Ordering data

Description	Type	Order No.	Pcs. / Pkt.
Monitoring non-equivalent signal generators	PSR-MS50-1NO-1DO-24DC-SC	2904956	1

Ordering data

Description	Type	Order No.	Pcs. / Pkt.
Monitoring non-equivalent signal generators	PSR-MS55-1NO-1DO-24DC-SC	2904957	1

new

Highly compact safety relays for emergency stop, safety door, and light grid monitoring

- Two-channel control
- 2 single-channel enabling current paths
- Basic insulation/reinforced insulation in part
- Automatic activation
- Up to Cat. 4/PL e according to EN ISO 13849-1, SILCL 3 according to IEC EN 62061



Automatic activation

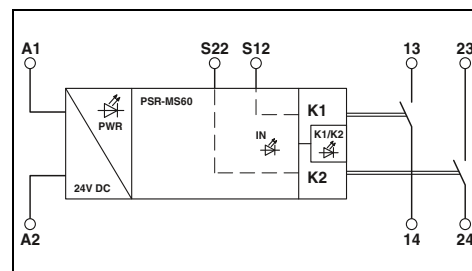

Technical data

Input data	
Rated control supply voltage U_s	24 V DC -15 % / +10 %
Rated control supply current I_s	typ. 40 mA
Typical response time	< 175 ms
Typical release time	< 20 ms (when controlled via A1 or S12 and S22)
Recovery time	< 500 ms
Output data	
Contact type	2 enabling current paths
Contact material	AgSnO ₂
Max./min. switching voltage	250 V AC/DC / 10 V AC/DC
Limiting continuous current	6 A (N/O contact)
Max./min. inrush current	6 A / 3 mA
Min. switching power	30 mW
Short-circuit protection of the output circuits	6 A gL/gG (N/O contact), 4 A gL/gG (for low-demand applications)
General data	
Ambient temperature range	-40 °C ... 55 °C (observe derating)
Air and creepage distances between the circuits	DIN EN 50178
Rated surge voltage/insulation	Safe isolation, reinforced insulation 6 kV between input circuit and enabling current path (13/14) and enabling current path (23/24) Basic insulation 4 kV between all current paths and housing
Screw connection solid / stranded / AWG	0.2 - 2.5 mm ² / 0.2 - 2.5 mm ² / 26 - 12
Dimensions	W / H / D 6.8 mm / 93.1 mm / 102.5 mm

Ordering data

Description	Type	Order No.	Pcs. / Pkt.
Emergency stop, safety door, and light grid monitoring	PSR-MS60-2NO-24DC-SC	2904958	1

Highly compact safety relays for emergency stop and safety door monitoring

- Single-channel control
- 3 enabling current paths, 1 digital signal output
- Basic insulation/reinforced insulation in part
- Manual, monitored, and automatic activation in a single device
- Cat. 1/PL c according to EN ISO 13849-1, SILCL 1 according to IEC 62061
- Depending on the application up to Cat. 4/PL e according to EN ISO 13849-1, SILCL 3 according to IEC 62061



new

3 enabling current paths

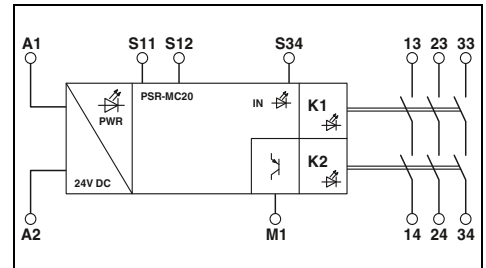

Technical data

Input data	
Rated control supply voltage U_S	24 V DC -15 % / +10 %
Rated control supply current I_S	typ. 80 mA
Typical response time	< 175 ms (automatic start) / < 175 ms (manual, monitored start)
Typical release time	< 20 ms (when controlled via A1 or S12)
Recovery time	< 500 ms
Output data	
Contact type	3 enabling current paths
Contact material	AgSnO ₂
Max./min. switching voltage	250 V AC/DC / 20 V AC/DC
Limiting continuous current	6 A (N/O contact)
Max./min. inrush current	6 A / 3 mA
Min. switching power	60 mW
Short-circuit protection of the output circuits	6 A gL/gG (N/O contact), 4 A gL/gG (for low-demand applications)
Alarm outputs	
Number of outputs	1 (digital, PNP)
Output current	Max. 100 mA
Short-circuit protection	no
General data	
Ambient temperature range	-40 °C ... 55 °C (observe derating)
Air and creepage distances between the circuits	DIN EN 50178
Rated surge voltage/insulation	Safe isolation, reinforced insulation 6 kV between input circuit and enabling current path (13/14) and enabling current path (23/24) and enabling current path (33/34) Basic insulation 4 kV between all current paths and housing
Screw connection solid / stranded / AWG	0.2 - 2.5 mm ² / 0.2 - 2.5 mm ² / 24 - 12
Spring-cage connection solid / stranded / AWG	0.2 - 1.5 mm ² / 0.2 - 1.5 mm ² / 24 - 16
Dimensions	12.5 mm / 112.2 mm / 114.5 mm
W / H / D	Screw version 12.5 mm / 112.2 mm / 114.5 mm Spring-cage version

Ordering data

Description	Type	Order No.	Pcs. / Pkt.
Emergency stop and safety door monitoring			
With screw connection	PSR-MC20-3NO-1DO-24DC-SC	2700466	1
With spring-cage connection	PSR-MC20-3NO-1DO-24DC-SP	2700467	1

Highly compact safety relays for emergency stop and safety door monitoring

- Two-channel control
- 2 or 3 enabling current paths, 1 digital signal output
- Basic insulation/reinforced insulation in part
- Cross-circuit detection
- Manual, monitored, and automatic activation in a single device
- Up to Cat. 4/PL e according to EN ISO 13849-1, SILCL 3 according to IEC EN 62061

new

new

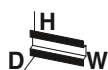

2 enabling current paths



3 enabling current paths

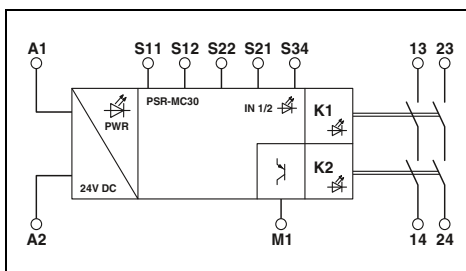

Technical data

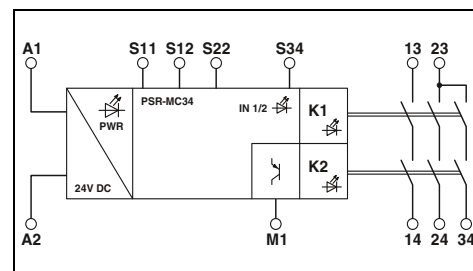

Technical data

Input data	
Rated control supply voltage U_s	24 V DC -15 % / +10 %
Rated control supply current I_s	typ. 65 mA
Typical response time	< 175 ms (automatic start) / < 175 ms (manual, monitored start)
Typical release time	
	< 20 ms (when controlled via A1 or S12 and S22)
Recovery time	
	< 500 ms
Output data	
Contact type	2 enabling current paths
Contact material	AgSnO ₂
Max./min. switching voltage	250 V AC/DC / 20 V AC/DC
Limiting continuous current	6 A (N/O contact)
Max./min. inrush current	
Min. switching power	60 mW
Short-circuit protection of the output circuits	6 A gL/gG (N/O contact), 4 A gL/gG (for low-demand applications)
Alarm outputs	
Number of outputs	1 (digital, PNP)
Output current	Max. 100 mA
Short-circuit protection	no
General data	
Ambient temperature range	-40 °C ... 55 °C (observe derating)
Air and creepage distances between the circuits	DIN EN 50178
Rated surge voltage/insulation	Safe isolation, reinforced insulation 6 kV between input circuit and enabling current path (13/14) and enabling current path (23/24) Basic insulation 4 kV between all current paths and housing
Screw connection solid / stranded / AWG	
	0.2 - 2.5 mm ² / 0.2 - 2.5 mm ² / 24 - 12
Spring-cage connection solid / stranded / AWG	
	0.2 - 1.5 mm ² / 0.2 - 1.5 mm ² / 24 - 16
Dimensions	12.5 mm / 112.2 mm / 114.5 mm
W / H / D	12.5 mm / 112.2 mm / 114.5 mm

Technical data	
Rated control supply voltage U_s	24 V DC -15 % / +10 %
Rated control supply current I_s	typ. 84 mA
Typical response time	< 175 ms (automatic start) / < 175 ms (manual, monitored start)
Typical release time	
	< 20 ms (when controlled via A1 or S12 and S22)
Recovery time	
	< 500 ms
Output data	
Contact type	3 enabling current paths
Contact material	AgSnO ₂
Max./min. switching voltage	250 V AC/DC / 20 V AC/DC
Limiting continuous current	6 A (N/O contact; as the 23/24/34 contact path only occupies one input path, only a total current of 6 A is permitted here)
Max./min. inrush current	
Min. switching power	60 mW
Short-circuit protection of the output circuits	6 A gL/gG (N/O contact), 4 A gL/gG (for low-demand applications)
Alarm outputs	
Number of outputs	1 (digital, PNP)
Output current	Max. 100 mA
Short-circuit protection	no
General data	
Ambient temperature range	-40 °C ... 55 °C (observe derating)
Air and creepage distances between the circuits	DIN EN 50178
Rated surge voltage/insulation	Basic insulation 4 kV: Between input circuit and enabling current path (23/24/34) Between all current paths and housing Safe isolation, reinforced insulation 6 kV: Between input circuit and enabling current path (13/14) Between enabling current path (13/14) and enabling current path (23/24/34)
Screw connection solid / stranded / AWG	
	0.2 - 2.5 mm ² / 0.2 - 2.5 mm ² / 24 - 12
Spring-cage connection solid / stranded / AWG	
	0.2 - 1.5 mm ² / 0.2 - 1.5 mm ² / 24 - 16
Dimensions	12.5 mm / 112.2 mm / 114.5 mm
W / H / D	12.5 mm / 112.2 mm / 114.5 mm

Ordering data

Ordering data

Description	Type	Order No.	Pcs. / Pkt.
Emergency stop and safety door monitoring			
With screw connection	PSR-MC30-2NO-1DO-24DC-SC	2700498	1
With spring-cage connection	PSR-MC30-2NO-1DO-24DC-SP	2700499	1

Description	Type	Order No.	Pcs. / Pkt.
Emergency stop and safety door monitoring			
With screw connection	PSR-MC34-3NO-1DO-24DC-SC	2700540	1
With spring-cage connection	PSR-MC34-3NO-1DO-24DC-SP	2700548	1

Highly compact safety relays for emergency stop, safety door, and light grid monitoring

- Two-channel control
- 3 enabling current paths, 1 digital signal output
- Basic insulation/reinforced insulation in part
- Manual, monitored, and automatic activation in a single device
- Up to Cat. 4/PL e according to EN ISO 13849-1, SILCL 3 according to IEC EN 62061

new



3 enabling current paths

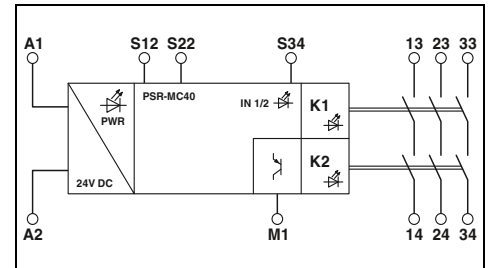

Technical data

Input data	
Rated control supply voltage U_s	24 V DC -15 % / +10 %
Rated control supply current I_s	typ. 80 mA
Typical response time	< 175 ms (automatic start) / < 175 ms (manual, monitored start)
Typical release time	< 20 ms (when controlled via A1 or S12 and S22)
Recovery time	< 500 ms
Output data	
Contact type	3 enabling current paths
Contact material	AgSnO ₂
Max./min. switching voltage	250 V AC/DC / 20 V AC/DC
Limiting continuous current	6 A (N/O contact)
Max./min. inrush current	6 A / 3 mA
Min. switching power	60 mW
Short-circuit protection of the output circuits	6 A gL/gG (N/O contact), 4 A gL/gG (for low-demand applications)
Alarm outputs	
Number of outputs	1 (digital, PNP)
Output current	Max. 100 mA
Short-circuit protection	no
General data	
Ambient temperature range	-40 °C ... 55 °C (observe derating)
Air and creepage distances between the circuits	DIN EN 50178
Rated surge voltage/insulation	Safe isolation, reinforced insulation 6 kV between input circuit and enabling current path (13/14) and enabling current path (23/24) and enabling current path (33/34) Basic insulation 4 kV between all current paths and housing
Screw connection solid / stranded / AWG	0.2 - 2.5 mm ² / 0.2 - 2.5 mm ² / 24 - 12
Spring-cage connection solid / stranded / AWG	0.2 - 1.5 mm ² / 0.2 - 1.5 mm ² / 24 - 16
Dimensions	Screw version 12.5 mm / 112.2 mm / 114.5 mm
W / H / D	Spring-cage version 12.5 mm / 112.2 mm / 114.5 mm

Ordering data

Description	Type	Order No.	Pcs. / Pkt.
Emergency stop, safety door, and light grid monitoring			
With screw connection	PSR-MC40-3NO-1DO-24DC-SC	2700569	1
With spring-cage connection	PSR-MC40-3NO-1DO-24DC-SP	2700570	1

new

Highly compact safety relays for monitoring non-equivalent signal generators

- Two-channel non-equivalent control
- 3 enabling current paths, 1 digital signal output
- Basic insulation/reinforced insulation in part
- Manual, monitored, and automatic activation in a single device
- Up to Cat. 4/PL e according to EN ISO 13849-1, SILCL 3 according to IEC EN 62061



3 enabling current paths, for non-equivalent sensor circuits

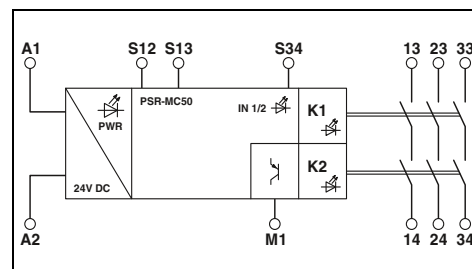

Technical data

Input data	24 V DC -15 % / +10 % typ. 80 mA < 175 ms (automatic start) / < 175 ms (manual, monitored start)
Rated control supply voltage U_s	
Rated control supply current I_s	
Typical response time	
Typical release time	< 20 ms (when controlled via A1 or S12 and S13)
Recovery time	< 500 ms
Output data	3 enabling current paths AgSnO ₂ 250 V AC/DC / 20 V AC/DC 6 A (N/O contact) 6 A / 3 mA 60 mW 6 A gL/gG (N/O contact), 4 A gL/gG (for low-demand applications)
Contact type	
Contact material	
Max./min. switching voltage	
Limiting continuous current	
Max./min. inrush current	
Min. switching power	
Short-circuit protection of the output circuits	
Alarm outputs	1 (digital, PNP) Max. 100 mA no
Number of outputs	
Output current	
Short-circuit protection	
General data	-40 °C ... 55 °C (observe derating) DIN EN 50178 Safe isolation, reinforced insulation 6 kV between input circuit and enabling current path (13/14) and enabling current path (23/24) and enabling current path (33/34) Basic insulation 4 kV between all current paths and housing
Ambient temperature range	
Air and creepage distances between the circuits	
Rated surge voltage/insulation	
Screw connection solid / stranded / AWG	0.2 - 2.5 mm ² / 0.2 - 2.5 mm ² / 24 - 12
Spring-cage connection solid / stranded / AWG	0.2 - 1.5 mm ² / 0.2 - 1.5 mm ² / 24 - 16
Dimensions	12.5 mm / 112.2 mm / 114.5 mm
W / H / D	12.5 mm / 112.2 mm / 114.5 mm
	Screw version
	Spring-cage version

Ordering data

Description	Type	Order No.	Pcs. / Pkt.
Monitoring non-equivalent signal generators			
With screw connection	PSR-MC50-3NO-1DO-24DC-SC	2700553	1
With spring-cage connection	PSR-MC50-3NO-1DO-24DC-SP	2700564	1

Safety relays for emergency stop and safety door monitoring

- Single-channel control
- 3 or 4 enabling current paths, 1 signaling current path
- Basic insulation
- Activation (depending on type): manual/automatic or manually monitored/automatic
- Cat. 1/PL c according to EN ISO 13849-1, SILCL 1 according to IEC 62061



Manual and automatic activation, 24 V AC/DC



Manually monitored and automatic activation, 230 V AC

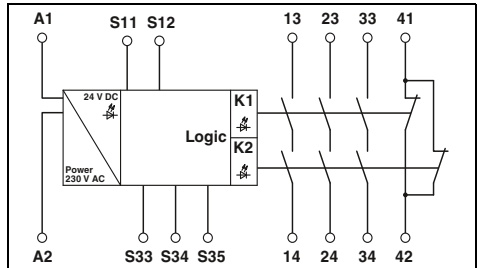
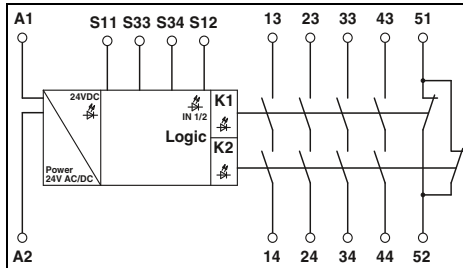

Technical data

Input data	
Nominal input voltage U_N	24 V AC/DC
Permissible range (with reference to U_N)	0.85 ... 1.1
Typ. current consumption (with reference to U_N)	140 mA AC / 65 mA DC
Typical response time	65 ms
Typical release time	45 ms
Recovery time	1 s
Output data	
Contact type	4 enabling current paths 1 signaling current path
Contact material	AgSnO ₂ , +0.2 μm Au
Max./min. switching voltage	250 V AC/DC / 15 V AC/DC
Limiting continuous current	6 A (N/O contact), 3 A (N/C contact)
Max./min. inrush current	6 A / 25 mA
Min. switching power	0.4 W
Switching capacity (360/h cycles)	4 A (24 V DC); 4 A (230 V AC)
Switching capacity (3600/h cycles)	2.5 A (24 V (DC13)); 3 A (230 V (AC 15))
Short-circuit protection of the output circuits	6 A fast blow, C6 (24 V AC/DC) automatic device
General data	
Ambient temperature range	-20 °C ... 55 °C
Air and creepage distances between the circuits	DIN EN 50178/VDE 0160
Rated surge voltage/insulation	4 kV / basic insulation (safe isolation, reinforced insulation, and 6 kV between input circuit/N/C contacts and enabling current paths)
Screw connection solid / stranded / AWG	0.2 - 2.5 mm ² / 0.2 - 2.5 mm ² / 24 - 12
Spring-cage connection solid / stranded / AWG	0.2 - 1.5 mm ² / 0.2 - 1.5 mm ² / 24 - 16
Dimensions	22.5 mm / 99 mm / 114.5 mm
W / H / D	22.5 mm / 112 mm / 114.5 mm
EMC note	Class A product, see page 527

Technical data

Nominal input voltage U_N	230 V AC
Permissible range (with reference to U_N)	0.85 ... 1.1
Typ. current consumption (with reference to U_N)	22 mA
Typical response time	50 ms (manual start) / 300 ms (automatic start)
Typical release time	20 ms (when controlled via S11/S12) / 150 ms (when controlled via A1)
Recovery time	1 s
Output data	
Contact type	3 enabling current paths 1 signaling current path
Contact material	AgSnO ₂ , gold-flashed
Max./min. switching voltage	250 V AC/DC / 10 V AC/DC
Limiting continuous current	6 A (N/O contact), 5 A (N/C contact)
Max./min. inrush current	6 A / 10 mA
Min. switching power	100 mW
Switching capacity (360/h cycles)	6 A (24 V DC); 5 A (230 V AC)
Switching capacity (3600/h cycles)	3 A (24 V (DC13)); 3 A (230 V (AC 15))
Short-circuit protection of the output circuits	10 A gL/gG NEOZED (enabling current paths), 6 A gL/gG NEOZED (signaling current paths)
General data	
Ambient temperature range	-25 °C ... 55 °C
Air and creepage distances between the circuits	DIN EN 50178/VDE 0160
Rated surge voltage/insulation	4 kV / basic insulation (safe isolation, reinforced insulation, and 6 kV between A1-A2/logic/enabling and signaling current paths)
Screw connection solid / stranded / AWG	0.2 - 2.5 mm ² / 0.2 - 2.5 mm ² / 24 - 12
Spring-cage connection solid / stranded / AWG	0.2 - 1.5 mm ² / 0.2 - 1.5 mm ² / 24 - 16
Dimensions	22.5 mm / 99 mm / 114.5 mm
W / H / D	22.5 mm / 112 mm / 114.5 mm
EMC note	Class A product, see page 527

Ordering data

Description	
Emergency stop and safety door monitoring , single-channel, activation: manual and automatic	
With screw connection	
With spring-cage connection	
Emergency stop and safety door monitoring , single-channel, activation: manually monitored and automatic	
With screw connection	
With spring-cage connection	

Type	Order No.	Pcs. / Pkt.
PSR-SCP-24UC/ESA2/4X1/1X2/B	2963802	1
PSR-SPP-24UC/ESA2/4X1/1X2/B	2963954	1

Ordering data

Type	Order No.	Pcs. / Pkt.
PSR-SCP-230AC/ESAM2/3X1/1X2/B	2901430	1
PSR-SPP-230AC/ESAM2/3X1/1X2/B	2901431	1

Safety relay for emergency stop and safety door monitoring

- Single- and two-channel control
- 2 enabling current paths, 1 signaling current path
- Reinforced insulation
- Manual, monitored, and automatic activation in a single device
- Up to Cat. 4/PL e according to EN ISO 13849-1, SILCL 3 according to IEC EN 62061

Notes:
Additional PSR safety relays with either automatically or manually monitored activation (PSR-ESA4 and PSR-ESM4) are available in the e-shop.



Manually monitored and automatic activation, reinforced insulation

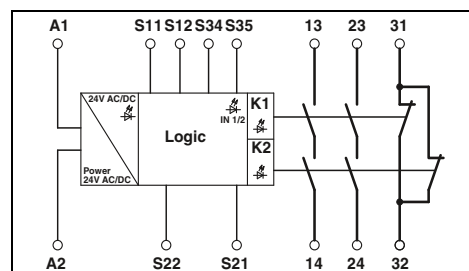

Technical data

Input data	24 V AC/DC 0.85 ... 1.1 140 mA AC / 65 mA DC 20 ms (manual start) / 150 ms (automatic start)
Nominal input voltage U_N	
Permissible range (with reference to U_N)	
Typ. current consumption (with reference to U_N)	
Typical response time	
Output data	45 ms (single-channel) / 10 ms (two-channel)
Typical release time	
Recovery time	1 s
General data	2 enabling current paths 1 signaling current path AgSnO ₂ , +0.2 μm Au 250 V AC/DC / 15 V AC/DC 6 A (N/O contact) 6 A / 25 mA 0.4 W 6 A (24 V DC); 5 A (230 V AC) 3 A (24 V (DC13)); 3 A (230 V (AC 15)) 10 A gL/gG NEOZED (N/O contact), 6 A gL/gG NEOZED (N/C contact)
Contact type	
Contact material	
Max./min. switching voltage	
Limiting continuous current	
Max./min. inrush current	
Min. switching power	
Switching capacity (360/h cycles)	
Switching capacity (3600/h cycles)	
Short-circuit protection of the output circuits	
Ambient temperature range	-20 °C ... 55 °C
Air and creepage distances between the circuits	DIN EN 50178/VDE 0160
Rated surge voltage/insulation	6 kV / safe isolation, reinforced insulation
Screw connection solid / stranded / AWG	0.2 - 2.5 mm ² / 0.2 - 2.5 mm ² / 24 - 12
Spring-cage connection solid / stranded / AWG	0.2 - 1.5 mm ² / 0.2 - 1.5 mm ² / 24 - 16
Dimensions	22.5 mm / 99 mm / 114.5 mm
W / H / D	22.5 mm / 112 mm / 114.5 mm
EMC note	Class A product, see page 527

Ordering data

Description	Type	Order No.	Pcs. / Pkt.
Emergency stop and safety door monitoring , single- and two-channel, activation: automatic and manually monitored			
With screw connection	PSR-SCP- 24UC/ESAM4/2X1/1X2	2900525	1
With spring-cage connection	PSR-SPP- 24UC/ESAM4/2X1/1X2	2900526	1

Safety relays for emergency stop and safety door monitoring

- single- and two-channel control
- 3 enabling current paths,
1 signaling current path
- Basic insulation
- Manual, monitored, and automatic activation in a single device
- Up to Cat. 4/PL e according to EN ISO 13849-1,
SILCL 3 according to IEC EN 62061

Notes:
Additional PSR safety relays with either automatically or manually monitored activation (PSR-ESA4 and PSR-ESM4) are available in the e-shop.



**Basic insulation,
24 V AC/DC**



**Basic insulation,
42 - 48 V, 60 V, 120 V, 230 V AC/DC**

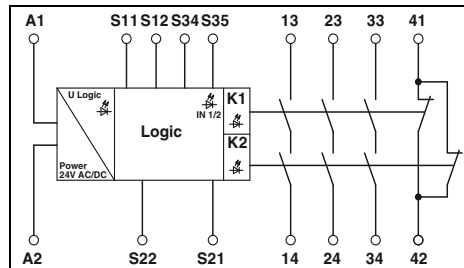

Technical data

Input data	24 V AC/DC
Nominal input voltage U_N	0.85 ... 1.1
Permissible range (with reference to U_N)	3.36 VA / 1.56 W
Typ. power consumption (with reference to U_N)	20 ms (manual start)
Typical response time	45 ms (single-channel) / 10 ms (two-channel)
Typical release time	1 s
Recovery time	
Output data	
Contact type	3 enabling current paths 1 signaling current path
Contact material	AgSnO ₂ , +0.2 μm Au
Max./min. switching voltage	250 V AC/DC / 10 V AC/DC
Limiting continuous current	6 A (N/O contact), 5 A (N/C contact)
Max./min. inrush current	6 A / 10 mA
Min. switching power	100 mW
Switching capacity (3600/h cycles)	6 A (24 V DC); 5 A (230 V AC)
Switching capacity (3600/h cycles)	3 A (24 V (DC13)); 3 A (230 V (AC 15))
Short-circuit protection of the output circuits	10 A gL/gG NEOZED (N/O contact), 6 A gL/gG NEOZED (N/C contact)
General data	
Ambient temperature range	-20 °C ... 55 °C
Air and creepage distances between the circuits	DIN EN 50178/VDE 0160
Rated surge voltage/insulation	4 kV / basic insulation, (safe isolation, reinforced insulation, and 6 kV between input circuit and enabling current paths)
Screw connection solid / stranded / AWG	0.2 - 2.5 mm ² / 0.2 - 2.5 mm ² / 24 - 12
Spring-cage connection solid / stranded / AWG	0.2 - 1.5 mm ² / 0.2 - 1.5 mm ² / 24 - 16
Dimensions	22.5 mm / 99 mm / 114.5 mm
W / H / D	22.5 mm / 112 mm / 114.5 mm
EMC note	Class A product, see page 527

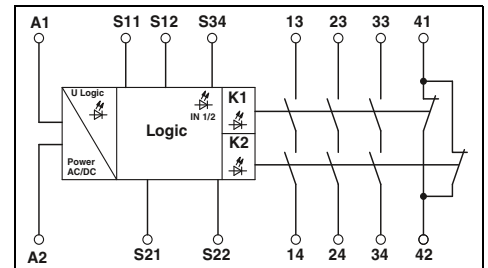

Technical data

42 V AC/DC ... 48 V AC/DC	230 V AC/DC
0.85 ... 1.1	0.85 ... 1.1
4.5 VA / 2 W	4.5 VA / 2 W
40 ms (manual start)	40 ms (manual start)
90 ms (when controlled via A1) / 20 ms (when controlled via S11/S12 and S21/S22)	150 ms (when controlled via A1) / 20 ms (when controlled via S11/S12 and S21/S22)
1 s	1 s
Contact type	3 enabling current paths 1 signaling current path
Contact material	AgSnO ₂ , +0.2 μm Au
Max./min. switching voltage	250 V AC/DC / 10 V AC/DC
Limiting continuous current	6 A (N/O contact), 5 A (N/C contact)
Max./min. inrush current	6 A / 10 mA
Min. switching power	100 mW
Switching capacity (3600/h cycles)	6 A (24 V DC); 5 A (230 V AC)
Switching capacity (3600/h cycles)	3 A (24 V (DC13)); 3 A (230 V (AC 15))
Short-circuit protection of the output circuits	10 A gL/gG NEOZED (N/O contact), 6 A gL/gG NEOZED (N/C contact)
Ambient temperature range	-25 °C ... 55 °C
Air and creepage distances between the circuits	DIN EN 50178/VDE 0160
Rated surge voltage/insulation	4 kV / basic insulation (safe isolation, reinforced insulation, and 6 kV between A1-A2/logic/enabling and signaling current paths)
Screw connection solid / stranded / AWG	0.2 - 2.5 mm ² / 0.2 - 2.5 mm ² / 24 - 12
Spring-cage connection solid / stranded / AWG	0.2 - 1.5 mm ² / 0.2 - 1.5 mm ² / 24 - 16
Dimensions	22.5 mm / 99 mm / 114.5 mm
W / H / D	22.5 mm / 112 mm / 114.5 mm
EMC note	Class A product, see page 527

Ordering data

Description	Type	Order No.	Pcs. / Pkt.
Emergency stop and safety door monitoring, with screw connection			
24 V AC/DC nominal input voltage	PSR-SCP-24UC/ESAM4/3X1/1X2/B	2900509	1
42 - 48 V AC/DC nominal input voltage			
60 V AC/DC nominal input voltage			
120 V AC/DC nominal input voltage			
230 V AC/DC nominal input voltage			
Emergency stop and safety door monitoring, with spring-cage connection			
24 V AC/DC nominal input voltage	PSR-SPP-24UC/ESAM4/3X1/1X2/B	2900510	1
42 - 48 V AC/DC nominal input voltage			
60 V AC/DC nominal input voltage			
120 V AC/DC nominal input voltage			
230 V AC/DC nominal input voltage			

Ordering data

Description	Type	Order No.	Pcs. / Pkt.
Emergency stop and safety door monitoring, with screw connection			
24 V AC/DC nominal input voltage	PSR-SCP-42-48UC/ESAM4/3X1/1X2/B	2901416	1
42 - 48 V AC/DC nominal input voltage			
60 V AC/DC nominal input voltage			
120 V AC/DC nominal input voltage			
230 V AC/DC nominal input voltage			
Emergency stop and safety door monitoring, with spring-cage connection			
24 V AC/DC nominal input voltage	PSR-SPP-42-48UC/ESAM4/3X1/1X2/B	2901417	1
42 - 48 V AC/DC nominal input voltage			
60 V AC/DC nominal input voltage			
120 V AC/DC nominal input voltage			
230 V AC/DC nominal input voltage			

Safety relays for emergency stop and safety door monitoring

- single- and two-channel control
- 3 or 8 enabling current paths, 1 signaling current path
- Manual, monitored, and automatic activation in a single device
- Up to Cat. 4/PL e according to EN ISO 13849-1, SILCL 3 according to IEC EN 62061



Reinforced insulation, 3 enabling current paths, wide range input (24 ... 230 V AC/DC)

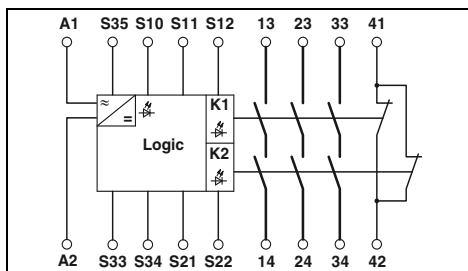

Technical data

Input data	
Nominal input voltage U_N	24 V AC/DC
Permissible range (with reference to U_N)	0.85 ... 1.1
Typ. current consumption (with reference to U_N)	120 mA (at 24 V DC) / 20 mA (for 120 V AC)
Typical response time	50 ms (manual start) / 60 ms (automatic start)
Typical release time	
	20 ms (when controlled via S11/S12 and S21/S22) / 50 ms (at 24 V DC)
Recovery time	
	1 s
Output data	
Contact type	
Contact material	3 enabling current paths 1 signaling current path AgSnO ₂ , +0.2 μm Au
Max./min. switching voltage	250 V AC/DC / 10 V AC/DC
Limiting continuous current	6 A (N/O contact), 6 A (N/C contact)
Max./min. inrush current	6 A / 10 mA
Min. switching power	360 mW
Switching capacity (360/h cycles)	4 A (24 V (DC13)); 4 A (230 V (AC 15))
Switching capacity (3600/h cycles)	2.5 A (24 V (DC13)); 3 A (230 V (AC 15))
Short-circuit protection of the output circuits	6 A gL/gG NEOZED (enabling current paths), 6 A gL/gG NEOZED (signaling current path)
General data	
Ambient temperature range	-20 °C ... 55 °C
Air and creepage distances between the circuits	DIN EN 50178/VDE 0160
Rated surge voltage/insulation	6 kV/safe isolation, reinforced insulation, and 6 kV between input circuits and output contact current paths (13/14, 23/24, 33/34), as well as between output contact current paths (13/14, 23/24, 33/34)
Screw connection solid / stranded / AWG	0.2 - 2.5 mm ² / 0.2 - 2.5 mm ² / 24 - 12
Spring-cage connection solid / stranded / AWG	0.2 - 1.5 mm ² / 0.2 - 1.5 mm ² / 24 - 16
Dimensions	45 mm / 99 mm / 114.5 mm
W / H / D	45 mm / 112 mm / 114.5 mm
EMC note	Class A product, see page 527

Ordering data

Description	Type	Order No.	Pcs. / Pkt.
Emergency stop and safety door monitoring , single- and two-channel, with/without cross-circuit detection, activation: manually monitored and automatic			
With screw connection	PSR-SCP-24-230UC/ESAM4/3X1/1X2	2981114	1
With spring-cage connection	PSR-SPP-24-230UC/ESAM4/3X1/1X2	2981127	1



Reinforced insulation, 8 enabling current paths

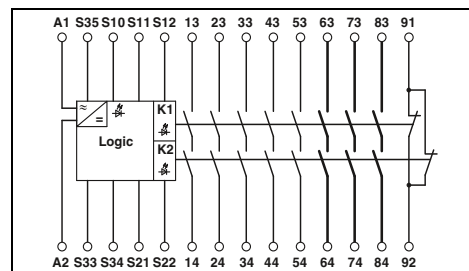

Technical data

Input data	
Nominal input voltage U_N	24 V AC/DC
Permissible range (with reference to U_N)	0.85 ... 1.1
Typ. current consumption (with reference to U_N)	210 mA AC / 120 mA DC
Typical response time	60 ms (manual start) / 250 ms (automatic start)
Typical release time	
	20 ms
Recovery time	
	1 s
Output data	
Contact type	
Contact material	8 enabling current paths 1 signaling current path AgSnO ₂ , +0.2 μm Au
Max./min. switching voltage	250 V AC/DC / 15 V AC/DC
Limiting continuous current	6 A
Max./min. inrush current	6 A / 25 mA
Min. switching power	0.4 W
Switching capacity (360/h cycles)	4 A (24 V DC); 4 A (230 V AC)
Switching capacity (3600/h cycles)	2.5 A (24 V (DC13)); 3 A (230 V (AC 15))
Short-circuit protection of the output circuits	6 A fast blow, C6 (24 V AC/DC) automatic device
General data	
Ambient temperature range	-20 °C ... 55 °C
Air and creepage distances between the circuits	DIN EN 50178/VDE 0160
Rated surge voltage/insulation	4 kV / basic insulation, (safe isolation, reinforced insulation, and 6 kV between input circuit and enabling current paths (63/64, 73/74, 83/84) and between 63/64, 73/74, 83/84 between each other)
Screw connection solid / stranded / AWG	0.2 - 2.5 mm ² / 0.2 - 2.5 mm ² / 24 - 12
Spring-cage connection solid / stranded / AWG	0.2 - 1.5 mm ² / 0.2 - 1.5 mm ² / 24 - 16
Dimensions	45 mm / 99 mm / 114.5 mm
W / H / D	45 mm / 112 mm / 114.5 mm
EMC note	Class A product, see page 527

Ordering data

Description	Type	Order No.	Pcs. / Pkt.
Emergency stop and safety door monitoring , single- and two-channel, with/without cross-circuit detection, activation: manually monitored and automatic			
With screw connection	PSR-SCP- 24UC/ESAM4/8X1/1X2	2963912	1
With spring-cage connection	PSR-SPP- 24UC/ESAM4/8X1/1X2	2963996	1

Safety relays with time functions

- For emergency stop and safety door monitoring and for evaluation of light grids (suitable light grids on request)
- single- and two-channel control
- 2 or 3 undelayed and 2 dropout delayed contacts
- Manual, monitored, and automatic activation in a single device
- Delay times adjustable from 0.1 s to 30 s (PSR-ESD-30) or 0.2 s to 300 s (PSR-ESD-300)
- Protection labels to prevent manipulation of the set time (PSR-ESD-300) or electronic manipulation protection (PSR-ESD-30)
- Up to Cat. 3/4 and PL d/e according to EN ISO 13849-1, SILCL 3 according to IEC 62061



Adjustable release delay time
0.1 - 30 s

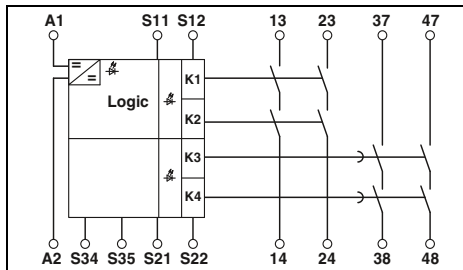

Technical data

Input data	24 V DC
Nominal input voltage U_N	0.85 ... 1.1
Permissible range (with reference to U_N)	75 mA DC
Typ. current consumption (with reference to U_N)	150 ms (monitored/manual and automatic start)
Typical response time	20 ms (undelayed contacts) / 100 ms (delayed contacts)
Typical release time	
Typical release time range	0.1 s ... 30 s
Recovery time	330 ms (restart)
Output data	
Contact type	2 undelayed enabling current paths 2 enabling current paths delayed
Contact material	AgSnO ₂
Max./min. switching voltage	250 V AC/DC / 15 V AC/DC
Limiting continuous current	6 A (N/O contact)
Max./min. inrush current	6 A / 25 mA
Min. switching power	0.4 W
Switching capacity (360/h cycles)	on request
Switching capacity (3600/h cycles)	3 A (24 V (DC13)); 3 A (230 V (AC15))
Short-circuit protection of the output circuits	10 A gL/gG NEOZED (N/O contact)
General data	
Ambient temperature range	-20 °C ... 45 °C
Air and creepage distances between the circuits	DIN EN 60947-1
Rated surge voltage/insulation	4 kV / basic insulation
Screw connection solid / stranded / AWG	0.2 - 2.5 mm ² / 0.2 - 2.5 mm ² / 24 - 12
Spring-cage connection solid / stranded / AWG	0.2 - 1.5 mm ² / 0.2 - 1.5 mm ² / 24 - 16
Dimensions	22.5 mm / 99 mm / 114.5 mm
W / H / D	22.5 mm / 112 mm / 114.5 mm
EMC note	Class A product, see page 527

Ordering data

Description	Type	Order No.	Pcs. / Pkt.
Emergency stop, safety door, and light grid monitoring , with delayed and undelayed contacts, single- and two-channel, adjustable, with/without cross-circuit detection, activation: manually monitored and automatic			
With screw connection	PSR-SCP- 24DC/ESD/4X1/30	2981800	1
With spring-cage connection	PSR-SPP- 24DC/ESD/4X1/30	2981813	1



Adjustable release delay time
0.2 - 300 s

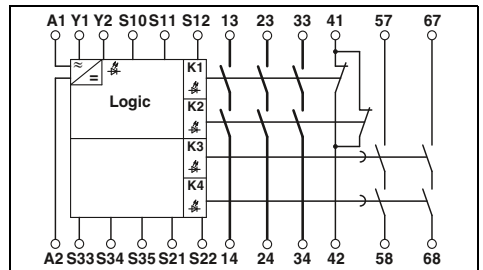

Technical data

24 V DC	0.85 ... 1.1
0.85 ... 1.1	155 mA DC
155 mA DC	70 ms (manual start) / 600 ms (automatic start)
70 ms (manual start) / 600 ms (automatic start)	20 ms (undelayed contacts)
20 ms (undelayed contacts)	
0.2 s ... 300 s	
1 s	
Output data	
Contact type	3 enabling current paths undelayed 2 enabling current paths delayed
Contact material	AgSnO ₂
Max./min. switching voltage	250 V AC/DC / 15 V AC/DC
Limiting continuous current	6 A (N/O contact), 3 A (N/C contact)
Max./min. inrush current	6 A / 25 mA
Min. switching power	0.4 W
Switching capacity (360/h cycles)	4 A (24 V DC); 4 A (230 V AC)
Switching capacity (3600/h cycles)	2.5 A (24 V (DC13)); 3 A (230 V (AC15))
Short-circuit protection of the output circuits	6 A fast blow (undelayed), 10 A gL/gG NEOZED (delayed)
General data	
Ambient temperature range	-20 °C ... 55 °C
Air and creepage distances between the circuits	DIN EN 50178/VDE 0160
Rated surge voltage/insulation	4 kV / basic insulation, (safe isolation, reinforced insulation, and 6 kV between the enabling current paths (13/14, 23/24, 33/34) and the remaining current paths and between 13/14, 23/24, 33/34 between each other)
Screw connection solid / stranded / AWG	0.2 - 2.5 mm ² / 0.2 - 2.5 mm ² / 24 - 12
Spring-cage connection solid / stranded / AWG	0.2 - 1.5 mm ² / 0.2 - 1.5 mm ² / 24 - 16
Dimensions	45 mm / 99 mm / 114.5 mm
W / H / D	45 mm / 112 mm / 114.5 mm
EMC note	Class A product, see page 527

Ordering data

Description	Type	Order No.	Pcs. / Pkt.
Emergency stop, safety door, and light grid monitoring , with delayed and undelayed contacts, single- and two-channel, adjustable, with/without cross-circuit detection, activation: manually monitored and automatic			
With screw connection	PSR-SCP- 24DC/ESD/5X1/1X2/300	2981428	1
With spring-cage connection	PSR-SPP- 24DC/ESD/5X1/1X2/300	2981431	1

Safety relays with time functions

- For emergency stop and safety door monitoring and for evaluation of light grids (suitable light grids on request)
- single- and two-channel control
- 3 undelayed and 2 drop-out contacts
- Manual, monitored, and automatic activation in a single device
- Fixed delay times of 0.5 s ... 30 s (see ordering data)
- Up to Cat. 3/4 and PL d/e according to EN ISO 13849-1, SILCL 3 according to IEC 62061



Fixed release delay time (versions), screw connection

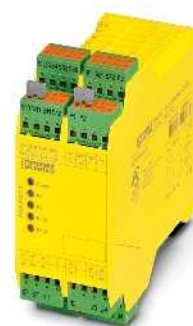
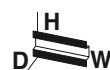

Fixed release delay time (versions), spring-cage connection

Notes:
Other time options available on request

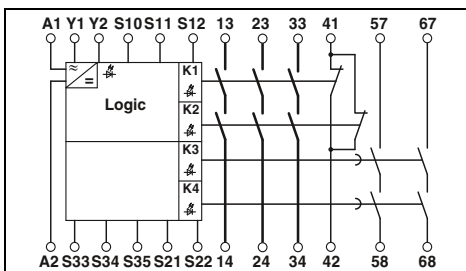

Technical data

Input data	
Nominal input voltage U_N	24 V DC
Permissible range (with reference to U_N)	0.85 ... 1.1
Typ. current consumption (with reference to U_N)	150 mA DC
Typical response time	70 ms (manual start) / 600 ms (automatic start)
Typical release time	20 ms (undelayed contacts)
Recovery time	1 s
Output data	
Contact type	3 enabling current paths undelayed 2 enabling current paths delayed 1 signaling current path undelayed
Contact material	
Max./min. switching voltage	AgSnO ₂
Limiting continuous current	250 V AC/DC / 15 V AC/DC
Max./min. inrush current	6 A
Min. switching power	6 A / 25 mA
Switching capacity (360/h cycles)	0.4 W
Switching capacity (3600/h cycles)	4 A (24 V DC); 4 A (230 V AC)
Short-circuit protection of the output circuits	2.5 A (24 V (DC13)); 3 A (230 V (AC 15))
General data	
Ambient temperature range	6 A fast blow (undelayed), C6 (24 V AC/DC) automatic device (undelayed), 10 A gL/gG NEOZED (delayed)
Air and creepage distances between the circuits	-20 °C ... 55 °C
Rated surge voltage/insulation	DIN EN 50178/VDE 0160
Connection data solid / stranded / AWG	4 kV / basic insulation, (safe isolation, reinforced insulation, and 6 kV between the enabling current paths (13/14, 23/24, 33/34) and the remaining current paths and between 13/14, 23/24, 33/34 between each other)
Dimensions	0.2 - 2.5 mm ² / 0.2 - 2.5 mm ² / 24 - 12
EMC note	45 mm / 99 mm / 114.5 mm

Technical data	
Nominal input voltage U_N	24 V DC
Permissible range (with reference to U_N)	0.85 ... 1.1
Typ. current consumption (with reference to U_N)	150 mA DC
Typical response time	70 ms (manual start) / 600 ms (automatic start)
Typical release time	20 ms (undelayed contacts)
Recovery time	1 s
Output data	
Contact type	3 enabling current paths undelayed 2 enabling current paths delayed 1 signaling current path undelayed
Contact material	
Max./min. switching voltage	AgSnO ₂
Limiting continuous current	250 V AC/DC / 15 V AC/DC
Max./min. inrush current	6 A
Min. switching power	6 A / 25 mA
Switching capacity (360/h cycles)	0.4 W
Switching capacity (3600/h cycles)	4 A (24 V DC); 4 A (230 V AC)
Short-circuit protection of the output circuits	2.5 A (24 V (DC13)); 3 A (230 V (AC 15))
General data	
Ambient temperature range	6 A fast blow (undelayed), C6 (24 V AC/DC) automatic device (undelayed), 10 A gL/gG NEOZED (delayed)
Air and creepage distances between the circuits	-20 °C ... 55 °C
Rated surge voltage/insulation	DIN EN 50178/VDE 0160
Connection data solid / stranded / AWG	4 kV / basic insulation, (safe isolation, reinforced insulation, and 6 kV between the enabling current paths (13/14, 23/24, 33/34) and the remaining current paths and between 13/14, 23/24, 33/34 between each other)
Dimensions	0.2 - 1.5 mm ² / 0.2 - 1.5 mm ² / 24 - 16
EMC note	45 mm / 112 mm / 114.5 mm

Ordering data

Description	Type	Order No.	Pcs. / Pkt.
Emergency stop and safety door monitoring			
Delay time 0.5 s	PSR-SCP- 24DC/ESD/5X1/1X2/0T 5	2981101	1
Delay time 1 s	PSR-SCP- 24DC/ESD/5X1/1X2/ T 1	2981143	1
Delay time 3 s	PSR-SCP- 24DC/ESD/5X1/1X2/ T 3	2981224	1
Delay time 5 s	PSR-SCP- 24DC/ESD/5X1/1X2/ T 5	2981266	1
Delay time 10 s	PSR-SCP- 24DC/ESD/5X1/1X2/ T10	2981088	1
Delay time 30 s	PSR-SCP- 24DC/ESD/5X1/1X2/ T30	2981347	1

Description	Type	Order No.	Pcs. / Pkt.
Emergency stop and safety door monitoring			
Delay time 0.5 s	PSR-SPP- 24DC/ESD/5X1/1X2/0T 5	2981130	1
Delay time 1 s	PSR-SPP- 24DC/ESD/5X1/1X2/ T 1	2981156	1
Delay time 3 s	PSR-SPP- 24DC/ESD/5X1/1X2/ T 3	2981237	1
Delay time 5 s	PSR-SPP- 24DC/ESD/5X1/1X2/ T 5	2981279	1
Delay time 10 s	PSR-SPP- 24DC/ESD/5X1/1X2/ T10	2981091	1
Delay time 30 s	PSR-SPP- 24DC/ESD/5X1/1X2/ T30	2981350	1

Safety relay for emergency stop, safety door, and light grid monitoring

- single- and two-channel control
- 1 enabling current path, 1 signaling current path
- Manual, monitored, and automatic activation in a single device
- Up to Cat. 4/PL e according to EN ISO 13849-1, SILCL 3 according to IEC EN 62061

Notes:
The PSR-SDC4 is also suitable for light grid monitoring, see page 51



Also ideal for
light grid monitoring

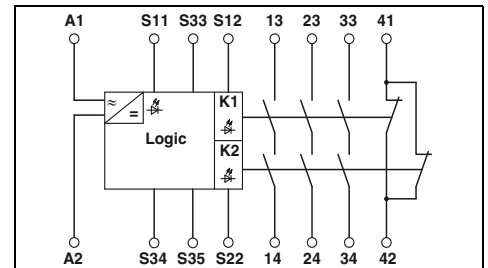

Technical data

Input data	Nominal input voltage U_N	24 V AC/DC
	Permissible range (with reference to U_N)	0.85 ... 1.1
	Typ. current consumption (with reference to U_N)	150 mA AC / 70 mA DC
	Typical response time	25 ms (manual start) / 100 ms (automatic start)
	Typical release time	10 ms
	Recovery time	1 s
Output data	Contact type	3 enabling current paths 1 signaling current path
	Contact material	AgSnO ₂ , +0.2 μm Au
	Max./min. switching voltage	250 V AC/DC / 15 V AC/DC
	Limiting continuous current	6 A
	Max./min. inrush current	6 A / 25 mA
	Min. switching power	0.4 W
	Switching capacity (360/h cycles)	6 A (24 V DC); 5 A (230 V AC)
	Switching capacity (3600/h cycles)	3 A (24 V (DC13)); 3 A (230 V (AC 15))
	Short-circuit protection of the output circuits	10 A gL/gG NEOZED (N/O contact)
General data	Ambient temperature range	-20 °C ... 55 °C
	Air and creepage distances between the circuits	DIN EN 50178/VDE 0160
	Rated surge voltage/insulation	4 kV / basic insulation (safe isolation, reinforced insulation, and 6 kV between A1-A2/logic/enabling and signaling current paths)
	Screw connection solid / stranded / AWG	0.2 - 2.5 mm ² / 0.2 - 2.5 mm ² / 24 - 12
	Spring-cage connection solid / stranded / AWG	0.2 - 1.5 mm ² / 0.2 - 1.5 mm ² / 24 - 16
	Dimensions	22.5 mm / 99 mm / 114.5 mm
	W / H / D	22.5 mm / 112 mm / 114.5 mm
	EMC note	Class A product, see page 527

Ordering data

Description	Type	Order No.	Pcs. / Pkt.
Optical data link emergency stop and safety door monitoring, single- and two-channel, activation: manually monitored and automatic			
With screw connection	PSR-SCP- 24UC/ESL4/3X1/1X2/B	2981059	1
With spring-cage connection	PSR-SPP- 24UC/ESL4/3X1/1X2/B	2981062	1

Safety relay for two-hand control systems

- For two-hand control devices as per EN 574 type IIIC
- Two-channel control
- 2 enabling current paths, 1 signaling current path
- Automatic activation
- Concurrence monitoring < 0.5 s
- Up to Cat. 4/PL e according to EN ISO 13849-1, SILCL 3 according to IEC EN 62061



Also ideal for two-hand controls

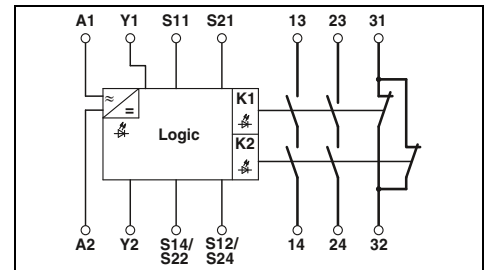

Technical data

Input data	
Nominal input voltage U_N	24 V AC/DC
Permissible range (with reference to U_N)	0.85 ... 1.1
Typ. current consumption (with reference to U_N)	125 mA AC / 60 mA DC
Typical response time	50 ms
Typical release time	20 ms
Recovery time	1 s
Output data	
Contact type	2 enabling current paths 1 signaling current path
Contact material	AgSnO ₂ , +0.2 μm Au
Max./min. switching voltage	250 V AC/DC / 15 V AC/DC
Limiting continuous current	6 A
Max./min. inrush current	6 A / 25 mA
Min. switching power	0.4 W
Switching capacity (360/h cycles)	4 A (24 V DC); 4 A (230 V AC)
Switching capacity (3600/h cycles)	2.5 A (24 V (DC13)); 3 A (230 V (AC 15))
Short-circuit protection of the output circuits	10 A gL/gG NEOZED (N/O contact), 6 A gL/gG NEOZED (N/C contact)
General data	
Ambient temperature range	-20 °C ... 55 °C
Air and creepage distances between the circuits	DIN EN 50178/VDE 0160
Rated surge voltage/insulation	6 kV / safe isolation, reinforced insulation
Screw connection solid / stranded / AWG	0.2 - 2.5 mm ² / 0.2 - 2.5 mm ² / 24 - 12
Spring-cage connection solid / stranded / AWG	0.2 - 1.5 mm ² / 0.2 - 1.5 mm ² / 24 - 16
Dimensions	22.5 mm / 99 mm / 114.5 mm
W / H / D	Screw version 22.5 mm / 112 mm / 114.5 mm
EMC note	Spring-cage version Class A product, see page 527

Ordering data

Description	Type	Order No.	Pcs. / Pkt.
Two-hand control units and safety door monitoring, two-channel, with cross-circuit detection, activation: automatic			
With screw connection	PSR-SCP- 24UC/THC4/2X1/1X2	2963721	1
With spring-cage connection	PSR-SPP- 24UC/THC4/2X1/1X2	2963983	1

Extension modules

- single- and two-channel control
- 5 enabling, 1 signaling, and 1 confirmation current path
- Option of basic insulation or reinforced insulation
- Up to Cat. 4/PL e according to EN ISO 13849-1, SILCL 3 according to IEC EN 62061



Contact extension with reinforced insulation



Applied for: Functional Safety

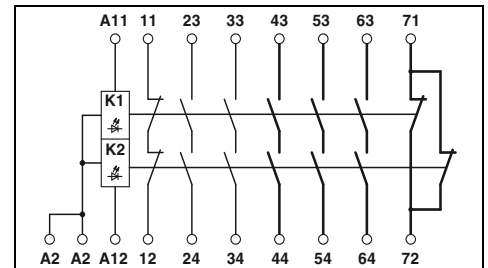

Technical data

Input data	
Nominal input voltage U_N	24 V AC/DC
Permissible range (with reference to U_N)	0.8 ... 1.1
Typ. current consumption (with reference to U_N)	47 mA (per channel)
	-
	-
Typ. release time (K1, K2) at U_N	20 ms
Typical response time	20 ms
Output data	
Contact type	5 enabling current paths 1 signaling current path 1 confirmation current path
Contact material	AgSnO ₂ , +0.2 μm Au
Max./min. switching voltage	250 V AC/DC / 15 V AC/DC
Limiting continuous current	6 A (N/O contact), 3 A (N/C contact 11/12)
Max./min. inrush current	6 A, 3 A (N/C contact 11/12) / 25 mA
Min. switching power	0.4 W
Switching capacity (360/h cycles)	4 A (24 V DC); 4 A (230 V AC)
Switching capacity (3600/h cycles)	2.5 A (24 V (DC13)); 3 A (230 V (AC 15))
Short-circuit protection of the output circuits	6 A fast blow, C6 (24 V AC/DC) automatic device
General data	
Ambient temperature range	-20 °C ... 55 °C
Air and creepage distances between the circuits	DIN EN 50178/VDE 0160
Rated surge voltage/insulation	4 kV / basic insulation, (safe isolation, reinforced insulation, and 6 kV between input circuit and enabling current paths (43/44, 53/54, 63/64, 71/72) and between 43/44, 53/54, 63/64, 71/72 between each other)
Screw connection solid / stranded / AWG	0.2 - 2.5 mm ² / 0.2 - 2.5 mm ² / 24 - 12
Spring-cage connection solid / stranded / AWG	0.2 - 1.5 mm ² / 0.2 - 1.5 mm ² / 24 - 16
Dimensions	35 mm / 99 mm / 114.5 mm
W / H / D	Screw version 35 mm / 112 mm / 114.5 mm
EMC note	Spring-cage version Class A product, see page 527

Ordering data

Description	Type	Order No.	Pcs. / Pkt.
Extension module with single- or two-channel control			
With screw connection	PSR-SCP- 24UC/URM4/5X1/2X2	2963734	1
With spring-cage connection	PSR-SPP- 24UC/URM4/5X1/2X2	2964005	1
Extension module , with single-channel control			
With screw connection			
With spring-cage connection			



Contact extension with basic insulation

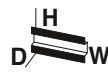

Contact extension for light grid



Contact extension with wide range input (42 - 230 V)

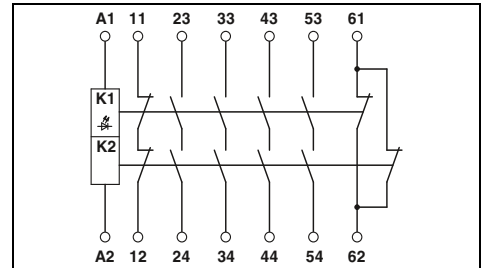
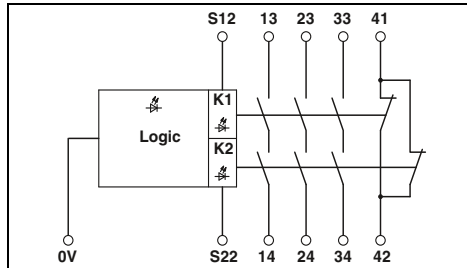
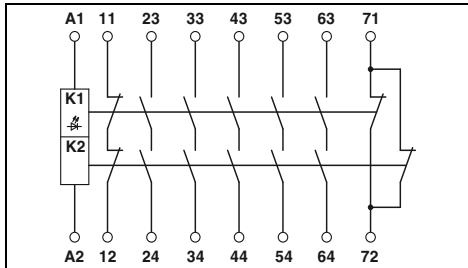

Technical data

Technical data

Technical data

24 V AC/DC
0.8 ... 1.1
92 mA
-
20 ms

24 V DC
0.85 ... 1.1
70 mA DC
-
10 ms

42 V AC/DC ... 230 V AC/DC
0.85 ... 1.1
40 mA (at 42 V DC) / 35 mA (at 48 V DC)
30 mA (at 60 V DC) / 30 mA (at 110 V AC)
20 mA (at 230 V AC)
20 ms (control via A1 at 42 V DC)
20 ms (control via A1 at 48 V DC)
20 ms (control via A1 at 60 V DC)
40 ms (control via A1 at 110 V AC)
85 ms (control via A1 at 230 V AC)
-

20 ms

25 ms (manual start)

5 enabling current paths
1 signaling current path
1 confirmation current path
AgSnO₂, +0.2 μm Au
250 V AC/DC / 15 V AC/DC
6 A (N/O contact), 3 A (N/C contact)
6 A (N/O contact), 3 A (N/C contact) / 25 mA
0.4 W
4 A (24 V DC); 4 A (230 V AC)
2.5 A (24 V (DC13)); 3 A (230 V (AC 15))
6 A fast blow, C6 (24 V AC/DC) automatic device

3 enabling current paths
1 signaling current path
AgSnO₂
250 V AC/DC / 15 V AC/DC
6 A (N/C contact / N/O contact)
6 A / 25 mA
0.4 W
6 A (24 V DC); 5 A (230 V AC)
3 A (24 V (DC13)); 3 A (230 V (AC 15))
10 A gL/gG NEOZED (N/O contact),
4 A gL/gG NEOZED (signaling current path)

4 enabling current paths
1 signaling current path
1 confirmation current path
AgSnO₂, +0.2 μm Au
250 V AC/DC / 15 V AC/DC
6 A (N/O contact), 6 A (N/C contact)
8 A / 25 mA
0.4 W
4 A (24 V (DC13)); 4 A (230 V (AC 15))
2.5 A (24 V (DC13)); 3 A (230 V (AC 15))
6 A gL/gG NEOZED (enabling current paths),
6 A gL/gG NEOZED (enabling current paths),
Miniature circuit breaker C6 (24 V / 20 A power supply unit)

-20 °C ... 55 °C
DIN EN 50178/VDE 0160
4 kV / basic insulation (safe isolation, reinforced insulation, and 6 kV between A1/A2, 11/12, 23/24, 71/72 and 33/34, 43/44, 53/54, 63/64)

-20 °C ... 55 °C
DIN EN 50178/VDE 0160
4 kV / basic insulation (safe isolation, reinforced insulation, and 6 kV between input circuit and enabling current paths)

-20 °C ... 55 °C
DIN EN 50178/VDE 0160
4 kV/basic insulation (safe isolation, reinforced insulation, and 6 kV between input circuit and enabling, signaling, and confirmation current paths)

0.2 - 2.5 mm² / 0.2 - 2.5 mm² / 24 - 12
0.2 - 1.5 mm² / 0.2 - 1.5 mm² / 24 - 16
22.5 mm / 99 mm / 114.5 mm
22.5 mm / 112 mm / 114.5 mm
Class A product, see page 527

0.2 - 2.5 mm² / 0.2 - 2.5 mm² / 24 - 12
0.2 - 1.5 mm² / 0.2 - 1.5 mm² / 24 - 16
22.5 mm / 99 mm / 114.5 mm
22.5 mm / 112 mm / 114.5 mm
Class A product, see page 527

0.2 - 2.5 mm² / 0.2 - 2.5 mm² / 24 - 12
0.2 - 1.5 mm² / 0.2 - 1.5 mm² / 24 - 16
22.5 mm / 99 mm / 114.5 mm
22.5 mm / 112 mm / 114.5 mm
Class A product, see page 527

Ordering data

Ordering data

Ordering data

Type	Order No.	Pcs. / Pkt.
PSR-SCP- 24UC/URM4/5X1/1X2/B	2981033	1
PSR-SPP- 24UC/URM4/5X1/2X2/B	2981046	1

Type	Order No.	Pcs. / Pkt.
PSR-SCP-24DC/URML4/3X1/1X2/B	2903583	1
PSR-SPP-24DC/URML4/3X1/1X2/B	2903584	1

Type	Order No.	Pcs. / Pkt.
PSR-SCP-42-230UC/URM4/4X1/2X2/B	2902935	1
PSR-SPP-42-230UC/URM4/4X1/2X2/B	2902936	1

Modular safety relay system



The PSR safety relay system reduces planning effort, simplifies wiring, and minimizes storage costs.

The PSR-SDC4 multifunctional master (can also be used as a stand-alone component) monitors the various safety-related signals - without the need for programming or additional switch settings. The relevant safety equipment (emergency stop buttons, safety door/solenoid switches, and light grids) is simply connected to the module.

If required, the PSR-URM4/B and PSR-URD3 extension devices can be used to integrate additional undelayed and dropout delayed contacts via the PSR-TBUS DIN rail connector.

The PSR-SIM4 interface module and PSR-SACB sensor box are suitable for wiring several safety switches with N/C or N/O contacts (e.g., in the case of multiple safety doors or safety flaps). The individual switches are automatically linked to one another and connected to the PSR-SDC4 master.

Additional signal outputs enable precise diagnostics.

- single- and two-channel control of the master
- Manual, monitored, and automatic activation in a single device
- With or without cross-circuit detection
- Up to Cat. 4/PL e according to EN ISO 13849-1, SILCL 3 according to IEC EN 62061
- Extension modules with adjustable release time: up to Cat. 3/PL d according to EN ISO 13849-1, SILCL 2 according to IEC EN 62061

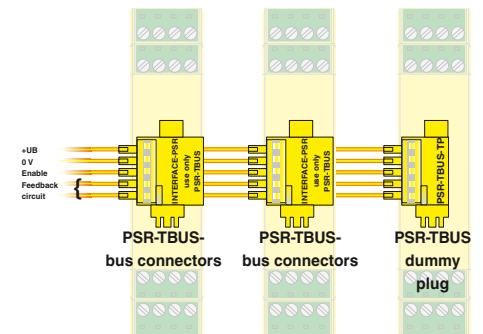

PSR-TBUS DIN rail connectors are used for cross-wiring between the modules.

Input data

Nominal input voltage U_N
 Permissible range (with reference to U_N)
 Typ. current consumption (with reference to U_N)
 Typical response time

Typical release time
 Typical release time range
 Recovery time

Output data

Contact type
 Contact material
 Max./min. switching voltage
 Limiting continuous current
 Max./min. inrush current
 Min. switching power
 Switching capacity (360/h cycles)
 Switching capacity (3600/h cycles)
 Short-circuit protection of the output circuits

General data

Ambient temperature range
 Air and creepage distances between the circuits
 Rated surge voltage/insulation

Screw connection solid / stranded / AWG

Spring-cage connection solid / stranded / AWG

Dimensions

W / H / D

EMC note

Screw version

Spring-cage version

Description

Master module for emergency stop, safety door, light grid, and magnetic switch

With screw connection

With spring-cage connection

Extension module, with single-channel control

With screw connection

With spring-cage connection

PSR-TBUS DIN rail connector, for supplying/controlling/monitoring (depending on the module)

PSR TBUS blind plug



PL
EN ISO 13849

SILCL
IEC 62061



Multifunctional master module



PL
EN ISO 13849

SILCL
IEC 62061



Extension module with 4 additional enabling current paths



PL
EN ISO 13849

SILCL
IEC 62061



Extension module with off-delay contacts (adjustable up to a max. of 3 s)

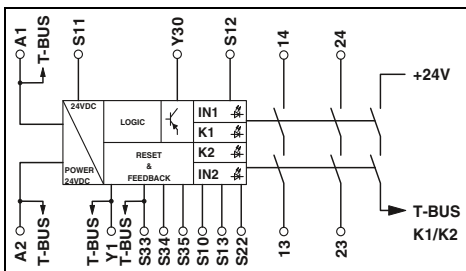

Technical data

24 V DC
0.85 ... 1.1
70 mA
20 ms (manual start) / 150 ms (automatic start)

10 ms
-
1 s

2 enabling current paths
1 semiconductor signaling output
AgSnO₂
250 V AC/DC / 15 V AC/DC
6 A (N/O contact), 100 mA (signal output)
6 A / 25 mA
0.4 W
6 A (24 V DC); 5 A (230 V (AC15))
3 A (24 V (DC13)); 3 A (230 V (AC15))
10 A gL/gG NEOZED (N/O contact),
Miniature circuit breaker C6 (24 V / 20 A power supply unit)

-20 °C ... 55 °C
DIN EN 50178/VDE 0160
4 kV / basic insulation, (safe isolation, reinforced insulation, and 6 kV between input circuit and enabling current paths)

0.2 - 2.5 mm² / 0.2 - 2.5 mm² / 24 - 12
0.2 - 1.5 mm² / 0.2 - 1.5 mm² / 24 - 16
22.5 mm / 99 mm / 114.5 mm
22.5 mm / 112 mm / 114.5 mm
Class A product, see page 527

Ordering data

Type	Order No.	Pcs. / Pkt.
PSR-SCP- 24DC/SDC4/2X1/B	2981486	1
PSR-SPP- 24DC/SDC4/2X1/B	2981499	1

Accessories

PSR-TBUS	2890425	50
PSR-TBUS-TP	2981716	50

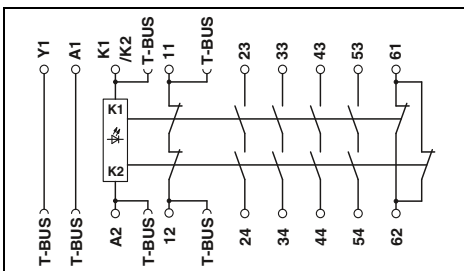

Technical data

24 V DC
0.9 ... 1.1
42 mA
10 ms

10 ms
-
1 s

4 enabling current paths
1 signaling current path
AgSnO₂
250 V AC/DC / 15 V AC/DC
6 A (N/O contact), 3 A (N/C contact)
6 A (N/O contact), 3 A (N/C contact) / 25 mA
0.4 W
6 A (24 V DC); 5 A (230 V AC)
3 A (24 V (DC13)); 3 A (230 V (AC15))
10 A gL/gG NEOZED (N/O contact),
4 A gL/gG NEOZED (N/C contact)

-20 °C ... 55 °C
DIN EN 50178/VDE 0160
4 kV / basic insulation (safe isolation, reinforced insulation, and 6 kV between input circuit/N/C contacts and enabling current paths)

0.2 - 2.5 mm² / 0.2 - 2.5 mm² / 24 - 12
0.2 - 1.5 mm² / 0.2 - 1.5 mm² / 24 - 16
22.5 mm / 99 mm / 114.5 mm
22.5 mm / 112 mm / 114.5 mm

Ordering data

Type	Order No.	Pcs. / Pkt.
PSR-SCP- 24DC/URM4/4X1/2X2/B	2981677	1
PSR-SPP- 24DC/URM4/4X1/2X2/B	2981680	1

Accessories

PSR-TBUS	2890425	50
PSR-TBUS-TP	2981716	50

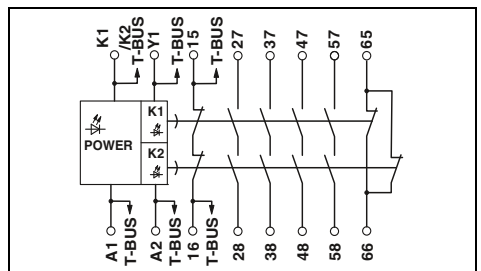

Technical data

24 V DC
0.85 ... 1.1
84 mA
20 ms

-
0.3 s ... 3 s
1 s

4 delayed enabling current paths
1 delayed signaling current path
AgSnO₂
250 V AC/DC / 15 V AC/DC
6 A (N/O contact), 3 A (N/C contact)
6 A (N/O contact), 3 A (N/C contact) / 25 mA
0.4 W
6 A (24 V DC); 5 A (230 V AC)
3 A (24 V (DC13)); 3 A (230 V (AC15))
10 A gL/gG NEOZED (N/O contact),
4 A gL/gG NEOZED (N/C contact)

-20 °C ... 55 °C
DIN EN 50178/VDE 0160
4 kV / basic insulation (safe insulation, reinforced insulation, and 6 kV between input circuit/N/C contacts and enabling current paths)

0.2 - 2.5 mm² / 0.2 - 2.5 mm² / 24 - 12
0.2 - 1.5 mm² / 0.2 - 1.5 mm² / 24 - 16
22.5 mm / 99 mm / 114.5 mm
22.5 mm / 112 mm / 114.5 mm
Class A product, see page 527

Ordering data

Type	Order No.	Pcs. / Pkt.
PSR-SCP- 24DC/URD3/4X1/2X2/3	2981732	1
PSR-SPP- 24DC/URD3/4X1/2X2/3	2981745	1

Accessories

PSR-TBUS	2890425	50
PSR-TBUS-TP	2981716	50

Modular safety relay system

- Single-channel control
- 4 enabling, 1 signaling, and 1 confirmation current path, all with dropout delay
- Up to Cat. 3/PL d according to EN ISO 13849-1, SILCL 2 according to IEC 62061



Extension module with off-delay contacts (adjustable up to a max. of 30 s)



Extension module with off-delay contacts (permanently set to 2 seconds)

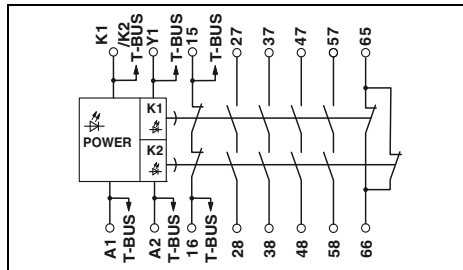

Technical data

Input data	24 V DC
Nominal input voltage U_N	0.85 ... 1.1
Permissible range (with reference to U_N)	84 mA
Typ. current consumption (with reference to U_N)	20 ms
Typical response time	-
Typical release time	0.5 s ... 38 s \pm 20 % (BG rating to max. 30 s)
Typical release time range	1 s
Recovery time	
Output data	
Contact type	4 delayed enabling current paths 1 delayed signaling current path 1 delayed confirmation current path
Contact material	AgSnO ₂
Max./min. switching voltage	250 V AC/DC / 15 V AC/DC
Limiting continuous current	6 A (N/O contact), 3 A (N/C contact)
Max./min. inrush current	6 A (N/O contact), 3 A (N/C contact) / 25 mA
Min. switching power	0.4 W
Switching capacity (3600/h cycles)	6 A (24 V DC); 5 A (230 V AC)
Switching capacity (3600/h cycles)	3 A (24 V (DC13)); 3 A (230 V (AC15))
Short-circuit protection of the output circuits	10 A gL/gG NEOZED (N/O contact), 4 A gL/gG NEOZED (N/C contact)
General data	
Ambient temperature range	-20 °C ... 55 °C
Air and creepage distances between the circuits	DIN EN 50178/VDE 0160
Rated surge voltage/insulation	4 kV / basic insulation (safe isolation, reinforced insulation, and 6 kV between input circuit/N/C contacts and enabling current paths)
Screw connection solid / stranded / AWG	0.2 - 2.5 mm ² / 0.2 - 2.5 mm ² / 24 - 12
Spring-cage connection solid / stranded / AWG	0.2 - 1.5 mm ² / 0.2 - 1.5 mm ² / 24 - 16
Dimensions	22.5 mm / 99 mm / 114.5 mm
W / H / D	22.5 mm / 112 mm / 114.5 mm
EMC note	Class A product, see page 527

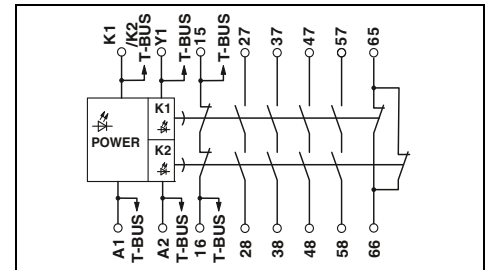

Technical data

Input data	24 V DC
Nominal input voltage U_N	0.85 ... 1.1
Permissible range (with reference to U_N)	84 mA
Typ. current consumption (with reference to U_N)	20 ms
Typical response time	2 s
Typical release time	-
Typical release time range	1 s
Recovery time	
Output data	
Contact type	4 delayed enabling current paths 1 delayed signaling current path 1 delayed confirmation current path
Contact material	AgSnO ₂
Max./min. switching voltage	250 V AC/DC / 15 V AC/DC
Limiting continuous current	6 A (N/O contact), 3 A (N/C contact)
Max./min. inrush current	6 A (N/O contact), 3 A (N/C contact) / 25 mA
Min. switching power	0.4 W
Switching capacity (3600/h cycles)	6 A (24 V DC); 5 A (230 V AC)
Switching capacity (3600/h cycles)	3 A (24 V (DC13)); 3 A (230 V (AC15))
Short-circuit protection of the output circuits	10 A gL/gG NEOZED (N/O contact), 4 A gL/gG NEOZED (N/C contact)
General data	
Ambient temperature range	-20 °C ... 55 °C
Air and creepage distances between the circuits	DIN EN 50178/VDE 0160
Rated surge voltage/insulation	4 kV / basic insulation (safe isolation, reinforced insulation, and 6 kV between input circuit/N/C contacts and enabling current paths)
Screw connection solid / stranded / AWG	0.2 - 2.5 mm ² / 0.2 - 2.5 mm ² / 24 - 12
Spring-cage connection solid / stranded / AWG	0.2 - 1.5 mm ² / 0.2 - 1.5 mm ² / 24 - 16
Dimensions	22.5 mm / 99 mm / 114.5 mm
W / H / D	22.5 mm / 112 mm / 114.5 mm
EMC note	Class A product, see page 527

Ordering data

Description	Type	Order No.	Pcs. / Pkt.
Extension module with drop-out delay contacts, single-channel control			
With screw connection	PSR-SCP- 24DC/URD3/4X1/2X2	2981512	1
With spring-cage connection	PSR-SPP- 24DC/URD3/4X1/2X2	2981525	1

Accessories

Accessories	Type	Order No.	Pcs. / Pkt.
PSR-TBUS DIN rail connector, for supplying/controlling/monitoring (depending on the module)	PSR-TBUS	2890425	50
PSR TBUS blind plug	PSR-TBUS-TP	2981716	50

Ordering data

Description	Type	Order No.	Pcs. / Pkt.
Extension module with drop-out delay contacts, single-channel control			
With screw connection	PSR-SCP- 24DC/URD3/4X1/2X2/T 2	2981703	1
With spring-cage connection	PSR-SPP- 24DC/URD3/4X1/2X2/T 2	2981729	1

Accessories

Accessories	Type	Order No.	Pcs. / Pkt.
PSR-TBUS DIN rail connector, for supplying/controlling/monitoring (depending on the module)	PSR-TBUS	2890425	50
PSR TBUS blind plug	PSR-TBUS-TP	2981716	50

Modular safety relay system

In machines and systems, connecting several two-channel safety switches to the evaluating safety relay is often time-consuming and requires a lot of wiring.

The PSR-SIM4 interface module can be used to connect up to two safety sensors or switches with one N/O or N/C combination each to the PSR-SDC4 safety relay easily and conveniently.

If more than four safety switches are required, several PSR-SIM4 modules can be quickly and easily interconnected via the PSR-TBUS DIN rail connector and evaluated by the PSR-SDC4 master safety relay.

- Four two-channel N/O or N/C inputs
- Four LEDs as the status indicator of the relevant sensor/switch
- Four PLC diagnostics outputs for evaluating the switching status of the safety sensors
- PSR-TBUS connection
- Up to Cat. 3/PL d according to EN ISO 13849-1, SILCL 2 according to IEC 62061 (in conjunction with the PSR-SDC4 master)

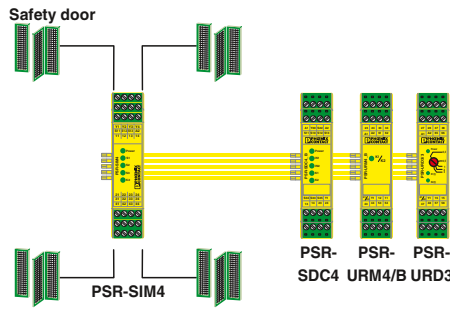

Up to 4 safety door switches can be connected to one PSR-SIM4.



Interface module for safety sensors and switches

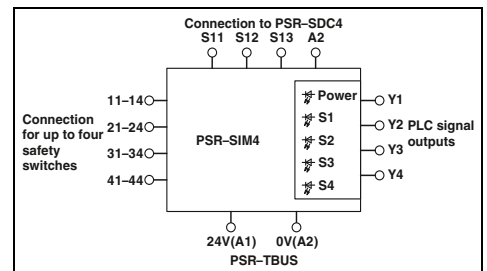

Technical data

Input data	
Nominal input voltage U_N	24 V DC (from PSR)
Input voltage range in reference to U_N	0.85 ... 1.1
Max. permissible current	100 mA (per signal output)
Max. permissible total current	100 mA (alarm outputs)
Status display	Green LED
General data	
Ambient temperature (operation)	-20 °C ... 55 °C
Nominal operating mode	100% operating factor
Degree of protection	IP20
Mounting position	any
Mounting	In rows with zero spacing
Air and creepage distances	DIN EN 50178
Rated insulation voltage	50 V DC
Rated surge voltage	0.8 kV
Screw connection solid / stranded / AWG	0.2 - 2.5 mm ² / 0.2 - 2.5 mm ² / 24 - 12
Spring-cage connection solid / stranded / AWG	0.2 - 1.5 mm ² / 0.2 - 1.5 mm ² / 24 - 16
Dimensions	22.5 mm / 99 mm / 106 mm
W / H / D	22.5 mm / 117 mm / 106 mm
	Screw version
	Spring-cage version

24 V DC (from PSR)
0.85 ... 1.1
100 mA (per signal output)
100 mA (alarm outputs)
Green LED

-20 °C ... 55 °C
100% operating factor
IP20
any
In rows with zero spacing
DIN EN 50178
50 V DC
0.8 kV
0.2 - 2.5 mm² / 0.2 - 2.5 mm² / 24 - 12
0.2 - 1.5 mm² / 0.2 - 1.5 mm² / 24 - 16
22.5 mm / 99 mm / 106 mm
22.5 mm / 117 mm / 106 mm

Ordering data

Type	Order No.	Pcs. / Pkt.
PSR-SCP- 24DC/SIM4	2981936	1
PSR-SPP- 24DC/SIM4	2981949	1

Accessories

PSR-TBUS	2890425	50
----------	---------	----

Description
Interface module , for up to four safety sensors/switches with N/O or N/C contacts
With screw connection
With spring-cage connection

PSR-TBUS DIN rail connector , for supplying/controlling/monitoring (depending on the module)

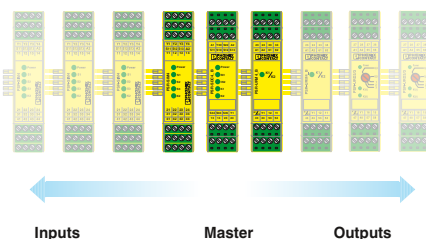

Additional inputs are aligned on the left of the PSR-SDC4, outputs are to its right.

Modular safety relay system

The safety-related wiring between the individual PSR modules is established automatically by the PSR-TBUS DIN rail connector. In addition to the supply voltage, an enable signal and the confirmation current path of the extension modules are routed via the connector. The blind plug (see below) closes the checkback circuit in the system.

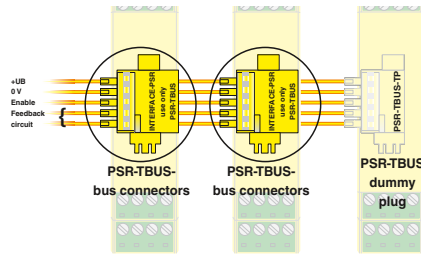

PSR-TBUS DIN rail connector

Description

PSR-TBUS DIN rail connector, for supplying/controlling/monitoring (depending on the module)

Ordering data

Type	Order No.	Pcs. / Pkt.
PSR-TBUS	2890425	50

Modular safety relay system

When structuring a modular safety relay system, the PSR-TBUS-TP is mounted under the module that completes the entire module on the right side. This closes the confirmation circuit of the system.

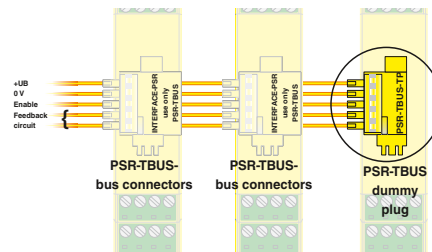

PSR-TBUS-TP blind plug

Description

PSR TBUS blind plug

Ordering data

Type	Order No.	Pcs. / Pkt.
PSR-TBUS-TP	2981716	50

Modular safety relay system

PSR-SACB sensor box with M12 slots

The PSR-SACB box for safety limit switches supports space-saving installation. It safely connects four connected limit switches, each with an N/C contact and an N/O contact, to a safety relay combination, e.g., PSR-SDC4. The N/C contacts are connected in series and the N/O contacts in parallel. Unused slots are bridged using blind plugs.

The LEDs are used for signaling. In addition, four signal outputs (Y1-Y4) are also available and they can be evaluated in the control unit. The boxes are suitable for a harsh industrial environment, correspond to the requirements of the IP65/67 degree of protection and are supplied with either a 5 m or 10 m cable length.

The appropriate connection cables for connection with sensors are available from a comprehensive range of products; see the PLUSCON catalog.

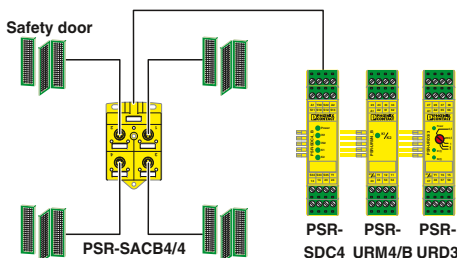

Signals of up to 4 safety door switches can be switched together directly in the field.



Sensor box, with connected master cable, with LED



Technical data

Nominal input voltage U_N	24 V DC (from PSR)
Input voltage range with reference to U_N	0.8 ... 1.1
Max. permissible current	100 mA (per signal output)
Max. permissible total current	100 mA (alarm outputs)
Status display	Yellow LED
Number of positions per slot	4
Master cable (stranded cable conduit-capable)	
Signal line cross section, stranded	6x 0.34 mm ²
Power supply cross section, stranded	2x 0.75 mm ²
External diameter	8.2 mm
Ambient temperature (operation)	-30 °C ... 70 °C (for fixed installation) -5 °C ... 70 °C (for flexible installation)

General data	
Ambient temperature (operation)	-20 °C ... 70 °C
Degree of protection	IP65/IP67
Mounting position	any
Mounting	In rows with zero spacing
Interfaces	Master cable suitable for drag chain applications / M12 socket
Air and creepage distances	
Rated insulation voltage	DIN EN 50178
Rated surge voltage	50 V DC
Insulation material (housing)	0.8 kV
Inflammability class according to UL 94	PA 6.6
Dimensions	V0 54 mm / 82 mm / 19 mm

Ordering data

Type	Order No.	Pcs. / Pkt.
PSR-SACB-4/4-L- 5,0PUR-SD	2981871	1
PSR-SACB-4/4-L-10,0PUR-SD	2981884	1

Accessories

SAC-2P-M12MS ASI TR	1539570	5
ZBN 18:UNBEDRUCKT	2809128	10

Description	W / H / D
Sensor box , with markers, for magnetic limit switch with N/C / N/O contacts	
Length of cable: 5 m	
Length of cable: 10 m	
Blind plug , for free slots	
Marking material	

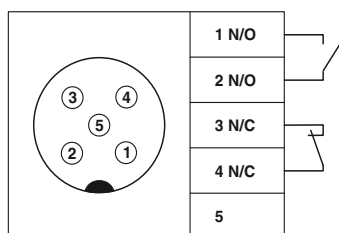

Wiring of the M12 contacts (open safety door)

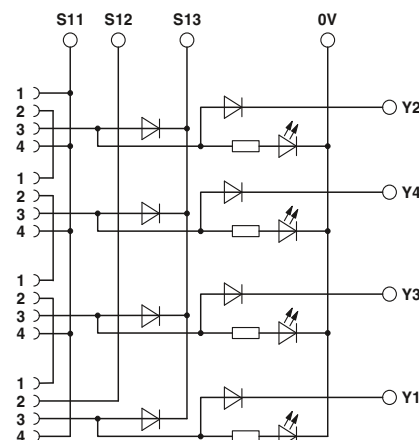

Block diagram

Multifunctional safety relays

You can easily implement three safety functions, such as emergency stop, safety door or light grid monitoring, with the PSR-MXF device range – and all using a single device.

In total, there are four function versions, each available with three connection methods.

Features:

- single- and two-channel control
- 2 x 2 enabling current paths, 2 digital signal outputs
- Basic insulation
- Manual, monitored, and automatic activation in a single device
- No software configuration required
- Up to Cat. 4/PL e according to EN ISO 13849-1, SILCL 3 according to IEC EN 62061

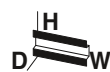

Screw connection



Spring-cage connection

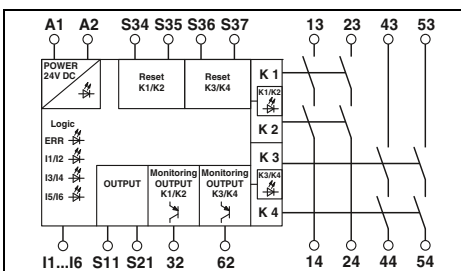

Technical data

Input data	
Nominal input voltage U_N	24 V DC
Permissible range (with reference to U_N)	0.85 ... 1.1
Typ. current consumption (with reference to U_N)	125 mA (with actuated relays) / 55 mA (two-channel 24 V/0 V + max. 200 mA control (message outputs 32/62) with non-actuated relays)
Recovery time	1 s (availability time after activation of sensor circuit: 100 ms)
Output data	
Contact type	4 enabling current paths 2 semiconductor alarm outputs
Contact material	AgCuNi, +0.2 - 0.4 μ m Au
Max./min. switching voltage	250 V AC/DC / 10 V AC/DC
Limiting continuous current	6 A (N/O contact), max. 100 mA (alarm output (24 V DC))
Max./min. inrush current	6 A / 10 mA
Min. switching power	0.1 W
Switching capacity (360/h cycles)	5 A (0.1 Hz; DC13; 24 V)
Switching capacity (3600/h cycles)	3 A (AC15; 230 V)
Short-circuit protection of the output circuits	6 A gL/gG NEOZED (N/O contact), 4 A gL/gG NEOZED (for low-demand applications)
General data	
Ambient temperature range	-20 °C ... 45 °C (see derating curve)
Air and creepage distances between the circuits	DIN EN 50178/VDE 0160
Rated surge voltage/insulation	4 kV/basic insulation (safe isolation, reinforced insulation, and 6 kV between input circuit, enabling current paths, and safety circuit 1 (13/14, 23/24) and safety circuit 2 (43/44, 53/54))
Screw connection solid / stranded / AWG	0.2 - 2.5 mm ² / 0.2 - 2.5 mm ² / 24 - 12
Dimensions	22.5 mm / 112.2 mm / 114.5 mm
EMC note	Class A product, see page 527

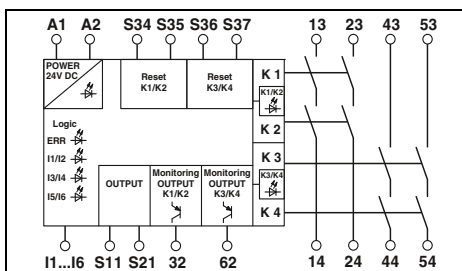

Technical data

Input data	
Nominal input voltage U_N	24 V DC
Permissible range (with reference to U_N)	0.85 ... 1.1
Typ. current consumption (with reference to U_N)	125 mA (with actuated relays) / 55 mA (two-channel 24 V/0 V + max. 200 mA control (message outputs 32/62) with non-actuated relays)
Recovery time	1 s (availability time after activation of sensor circuit: 100 ms)
Output data	
Contact type	4 enabling current paths 2 semiconductor alarm outputs
Contact material	AgCuNi, +0.2 - 0.4 μ m Au
Max./min. switching voltage	250 V AC/DC / 10 V AC/DC
Limiting continuous current	6 A (N/O contact), max. 100 mA (alarm output (24 V DC))
Max./min. inrush current	6 A / 10 mA
Min. switching power	0.1 W
Switching capacity (360/h cycles)	5 A (0.1 Hz; DC13; 24 V)
Switching capacity (3600/h cycles)	3 A (AC15; 230 V)
Short-circuit protection of the output circuits	6 A gL/gG NEOZED (N/O contact), 4 A gL/gG NEOZED (for low-demand applications)
General data	
Ambient temperature range	-20 °C ... 45 °C (see derating curve)
Air and creepage distances between the circuits	DIN EN 50178/VDE 0160
Rated surge voltage/insulation	4 kV/basic insulation (safe isolation, reinforced insulation, and 6 kV between input circuit, enabling current paths, and safety circuit 1 (13/14, 23/24) and safety circuit 2 (43/44, 53/54))
Screw connection solid / stranded / AWG	0.2 - 1.5 mm ² / 0.2 - 1.5 mm ² / 24 - 16
Dimensions	22.5 mm / 117.4 mm / 114.5 mm
EMC note	Class A product, see page 527

Ordering data

Description	Type	Order No.	Pcs. / Pkt.
Multifunctional safety relay , three safety functions, single- and two-channel, two local shutdown levels			
- Emergency stop and safety door monitoring	PSR-SCP-24DC/MXF1/4X1/2X2/B	2902725	1
- Emergency stop and magnetic switch monitoring	PSR-SCP-24DC/MXF2/4X1/2X2/B	2903254	1
- Emergency stop, safety door, and light grid monitoring	PSR-SCP-24DC/MXF3/4X1/2X2/B	2903257	1
- Emergency stop, magnetic switch, and light grid monitoring	PSR-SCP-24DC/MXF4/4X1/2X2/B	2903260	1

Ordering data

Description	Type	Order No.	Pcs. / Pkt.
Multifunctional safety relay , three safety functions, single- and two-channel, two local shutdown levels			
- Emergency stop and safety door monitoring	PSR-SPP-24DC/MXF1/4X1/2X2/B	2902726	1
- Emergency stop and magnetic switch monitoring	PSR-SPP-24DC/MXF2/4X1/2X2/B	2903255	1
- Emergency stop, safety door, and light grid monitoring	PSR-SPP-24DC/MXF3/4X1/2X2/B	2903258	1
- Emergency stop, magnetic switch, and light grid monitoring	PSR-SPP-24DC/MXF4/4X1/2X2/B	2903261	1

Safety switching devices for machine building – PSRmultifunction



Push-in connection

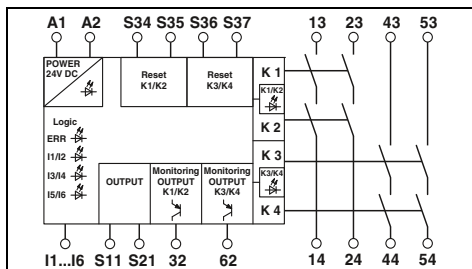

Technical data

24 V DC
 0.85 ... 1.1
 125 mA (with actuated relays) / 55 mA (two-channel 24 V/0 V + max. 200 mA control (message outputs 32/62) with non-actuated relays)

1 s (availability time after activation of sensor circuit: 100 ms)

4 enabling current paths
 2 semiconductor alarm outputs
 AgCuNi, +0.2 - 0.4 μm Au
 250 V AC/DC / 10 V AC/DC
 6 A (N/O contact), max. 100 mA (alarm output (24 V DC))

6 A / 10 mA
 0.1 W
 5 A (0.1 Hz; DC13; 24 V)
 3 A (AC15; 230 V)
 6 A gL/gG NEOZED (N/O contact),
 4 A gL/gG NEOZED (for low-demand applications)

-20 °C ... 45 °C (see derating curve)
 DIN EN 50178/VDE 0160
 4 kV/basic insulation (safe isolation, reinforced insulation, and 6 kV between input circuit, enabling current paths, and safety circuit 1 (13/14, 23/24) and safety circuit 2 (43/44, 53/54))

0.2 - 2.5 mm² / 0.2 - 2.5 mm² / 24 - 12
 22.5 mm / 106.4 mm / 114.5 mm
 Class A product, see page 527

Ordering data

Type	Order No.	Pcs. / Pkt.
PSR-PIP-24DC/MXF1/4X1/2X2/B	2903253	1
PSR-PIP-24DC/MXF2/4X1/2X2/B	2903256	1
PSR-PIP-24DC/MXF3/4X1/2X2/B	2903259	1
PSR-PIP-24DC/MXF4/4X1/2X2/B	2903262	1

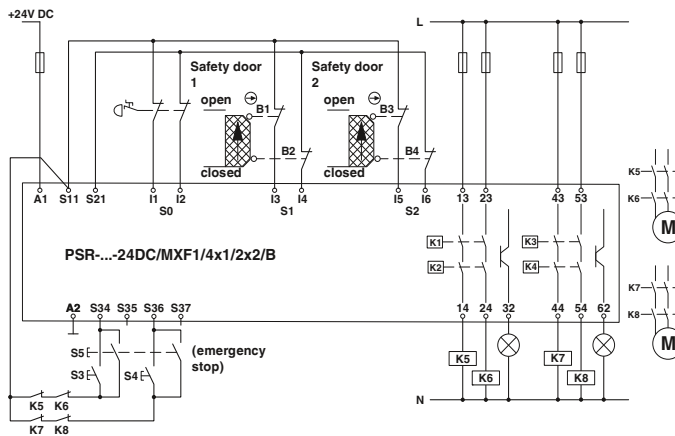

Emergency stop and safety door monitoring

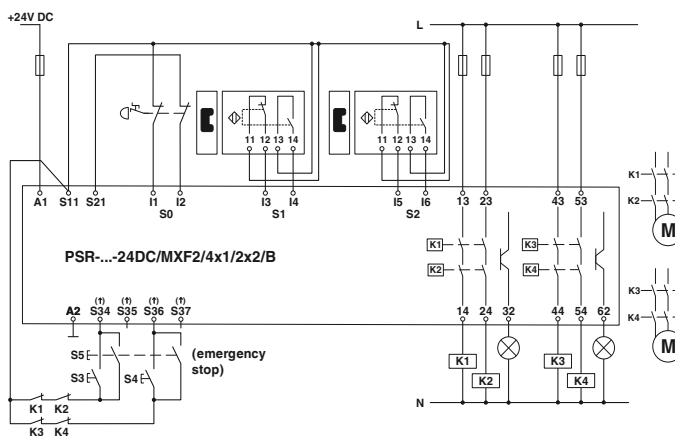

Emergency stop and magnetic switch monitoring

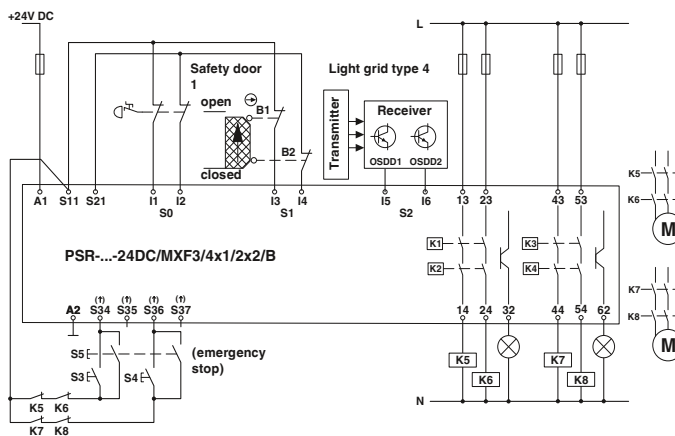

Emergency stop, safety door, and light grid monitoring

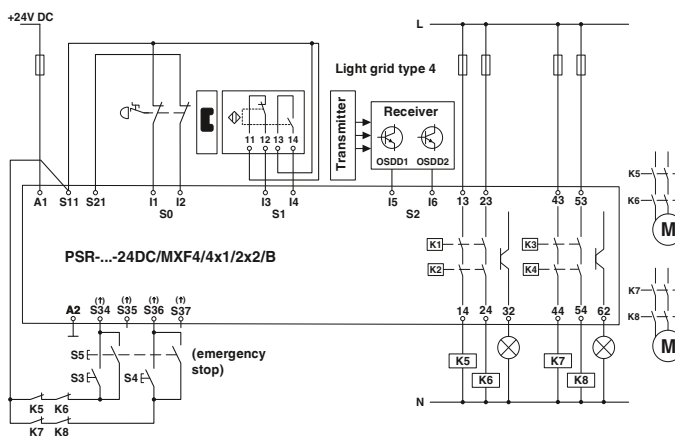

Emergency stop, magnetic switch, and light grid monitoring

Applications

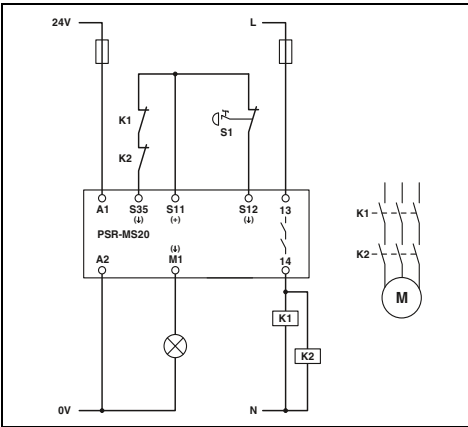

PSR-MS20

Single-channel emergency stop monitoring with automatic start

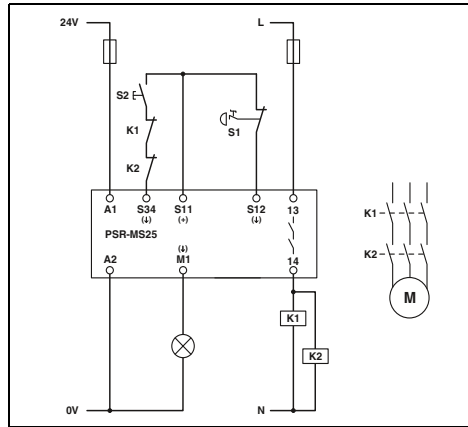

PSR-MS25

Single-channel emergency stop monitoring with manual, monitored start

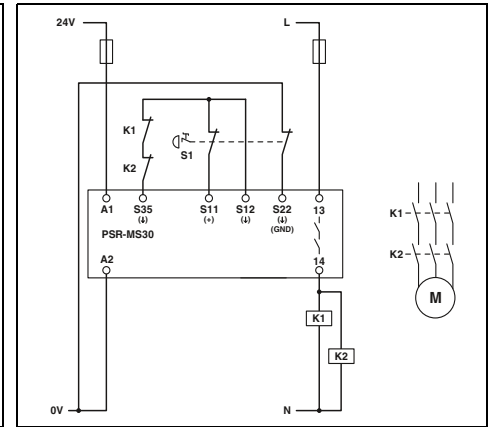

PSR-MS30

Two-channel emergency stop monitoring with automatic start

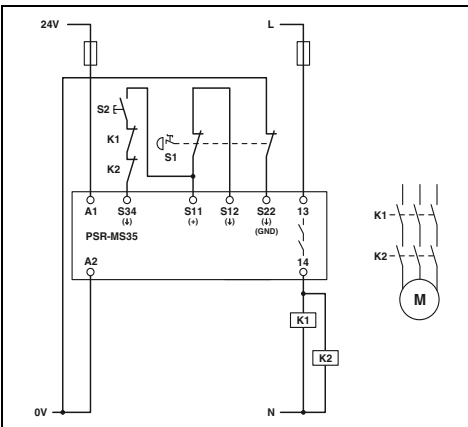

PSR-MS35

Two-channel emergency stop monitoring with manual, monitored start

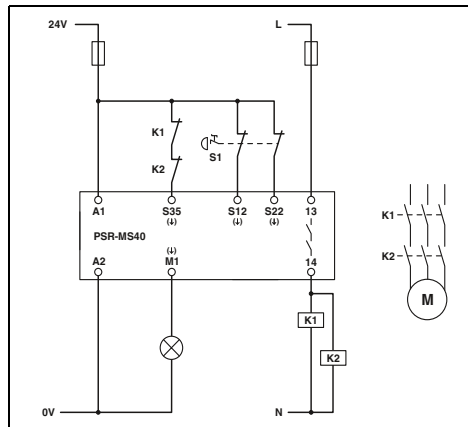

PSR-MS40

Two-channel emergency stop monitoring with automatic start (no cross-circuit detection in the sensor circuit)

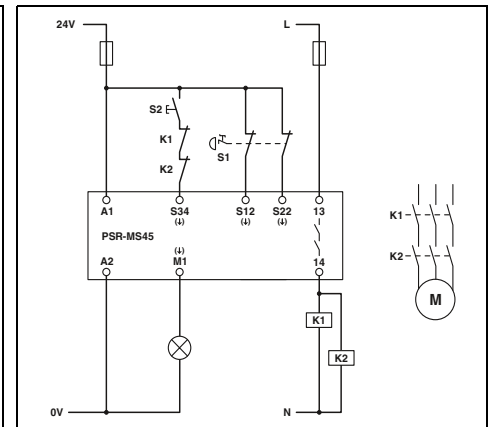

PSR-MS45

Two-channel emergency stop monitoring with manual, monitored start (no cross-circuit detection in the sensor circuit)

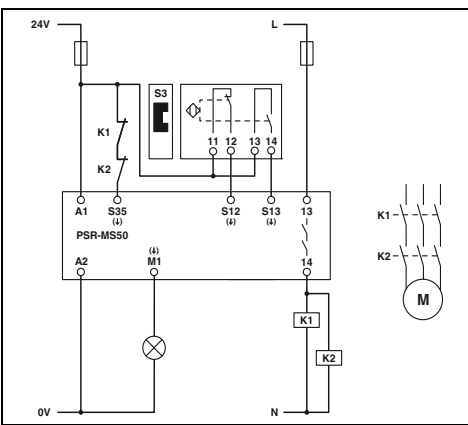

PSR-MS50

Two-channel, non-equivalent magnetic switch monitoring with automatic start

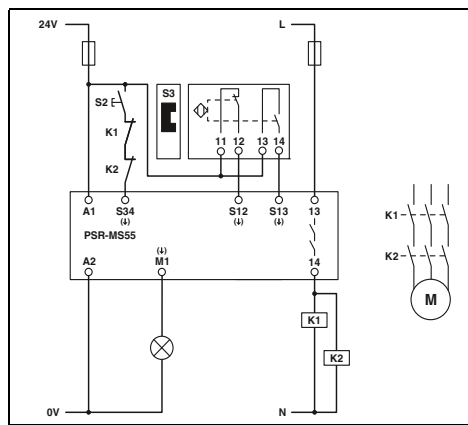

PSR-MS55

Two-channel, non-equivalent magnetic switch monitoring with manual, monitored start

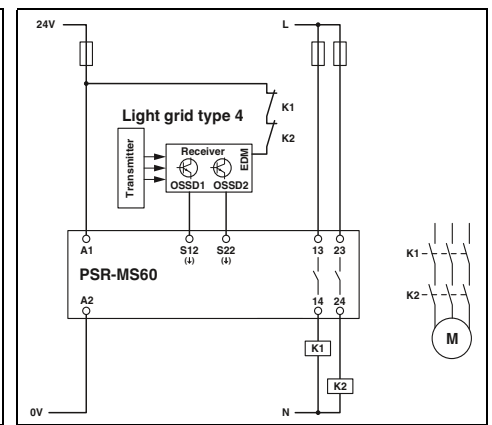

PSR-MS60

Two-channel light grid monitoring with automatic start

Applications

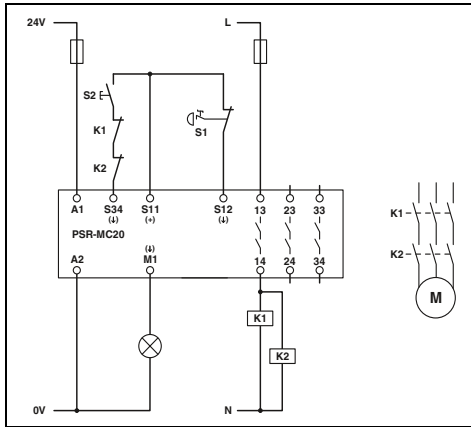

PSR-MC20

Single-channel emergency stop monitoring with manual, monitored start

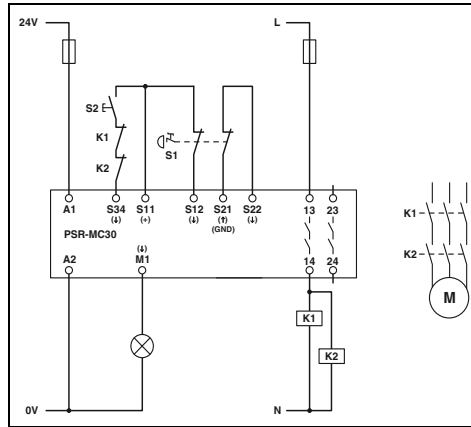

PSR-MC30

Two-channel emergency stop monitoring with manual, monitored start

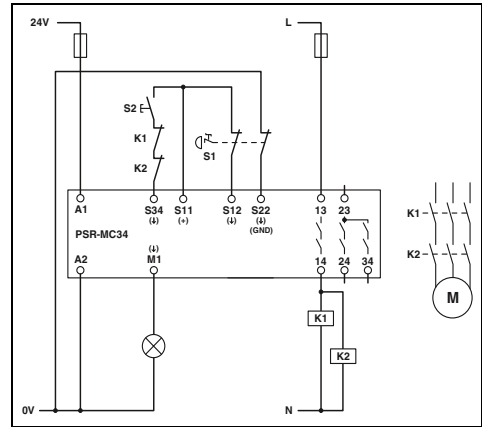

PSR-MC34

Two-channel emergency stop monitoring with manual, monitored start

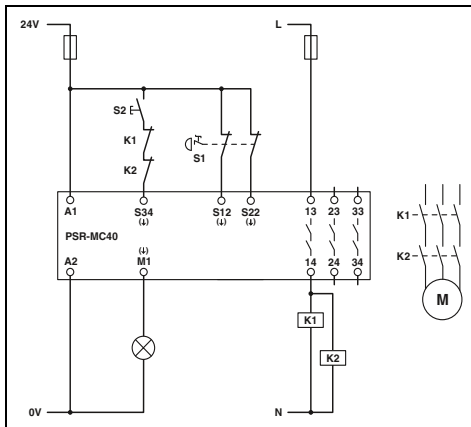

PSR-MC40

Two-channel emergency stop monitoring with manual, monitored start (no cross-circuit detection in the sensor circuit)

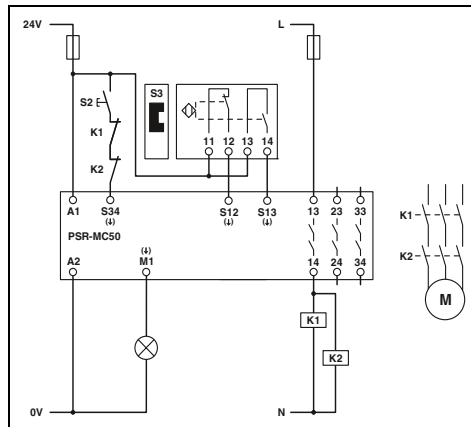

PSR-MC50

Two-channel, non-equivalent magnetic switch monitoring with manual, monitored start

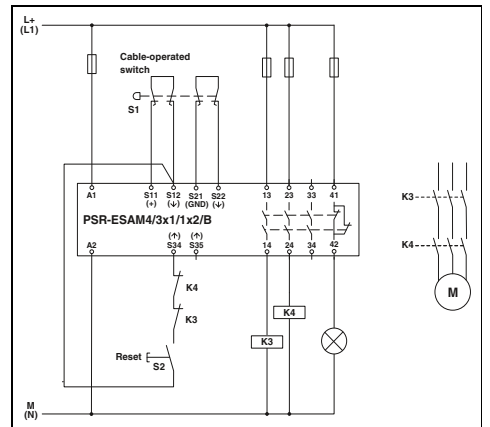

PSR-ESAM4/3X1-B

Two-channel monitoring of a cable-operated switch with manual, monitored start; cross-circuit detection; automatic activation: bridge at S12/S35

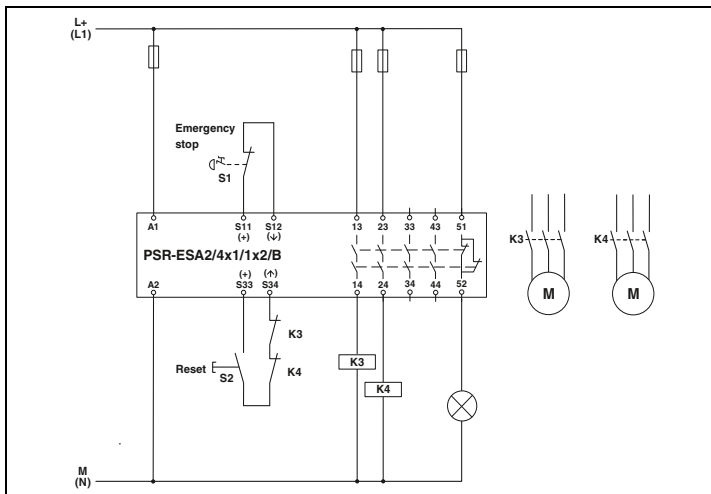

PSR-ESA2-B

Single-channel emergency stop monitoring with manual start; automatic activation: bridge at S33/S34

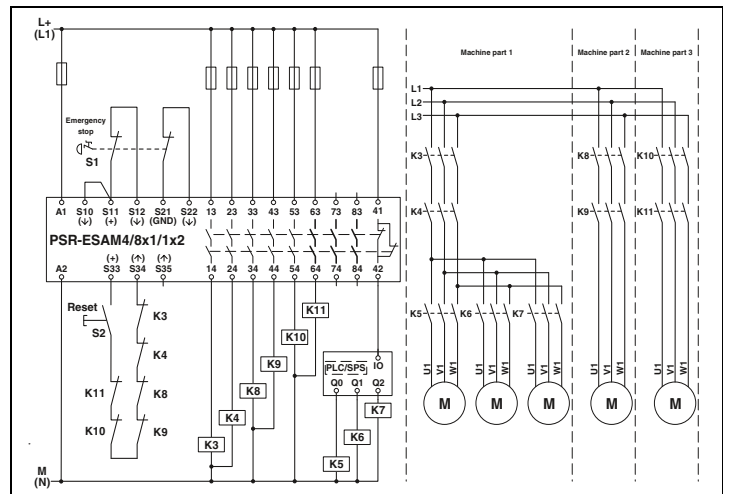

PSR-ESAM4/8X1

Two-channel emergency stop monitoring with manual, monitored start; cross-circuit detection; automatic activation: bridge at S33/S35

Applications

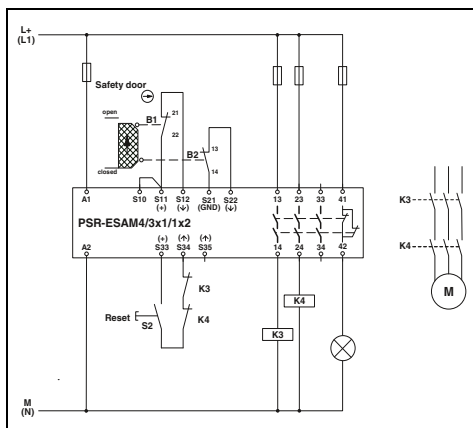

PSR-ESAM4/3X1/24-230UC

Two-channel safety door monitoring with manual, monitored start; cross-circuit detection; automatic activation: bridge at S33/S35

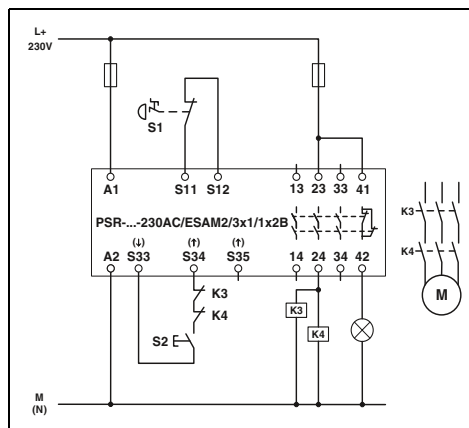

PSR-ESAM2/3X1-B

Single-channel emergency stop monitoring with manual, monitored start; automatic activation: bridge at S33/S35

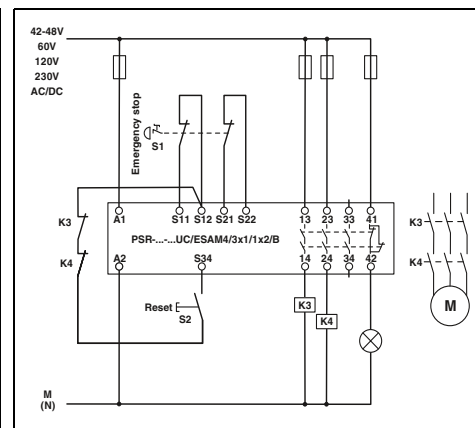

PSR-ESAM4/3X1-B

Two-channel emergency stop monitoring with manual, monitored start; cross-circuit detection; automatic activation: bridge at S22/S34

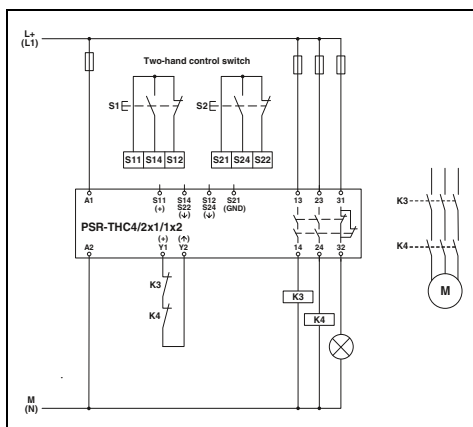

PSR-THC4

Monitoring of a two-hand controller with automatic start; equality monitoring according to EN 574 Type IIIc

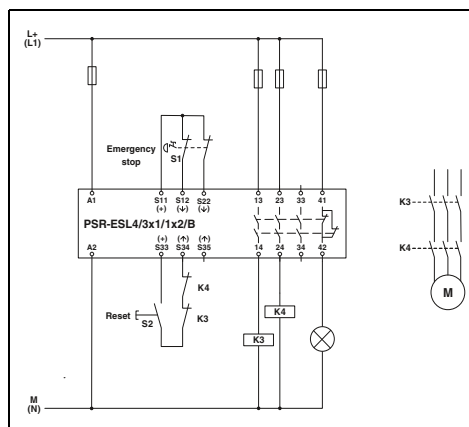

PSR-ESL4

Two-channel emergency stop monitoring with manual, monitored start; cross-circuit detection; automatic activation: bridge at S33/S35

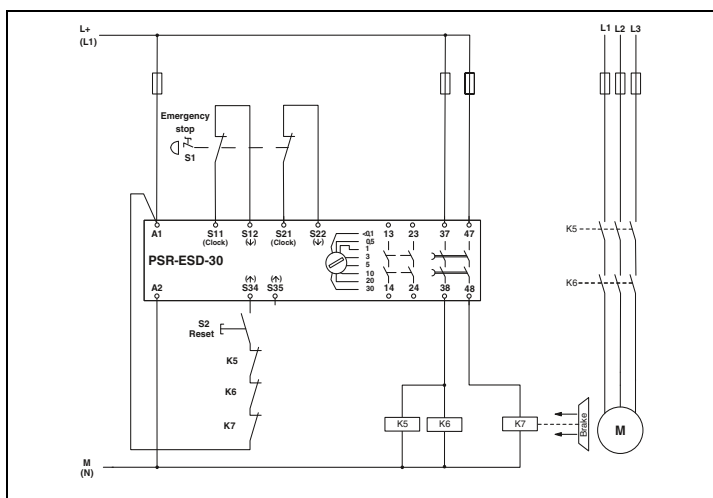

PSR-ESD-30

Two-channel emergency stop monitoring with manual, monitored start; cross-circuit detection; automatic activation: bridge at A1/S35

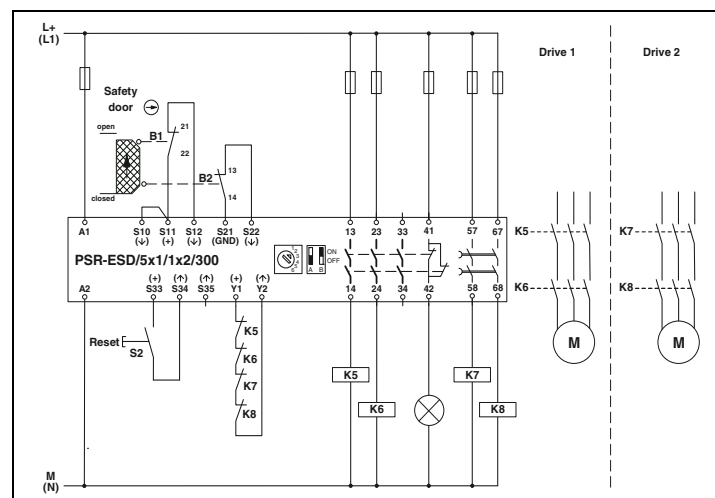

PSR-ESD-300

Two-channel safety door monitoring with manual, monitored start; cross-circuit detection; automatic activation: bridge at S33/S35

Applications

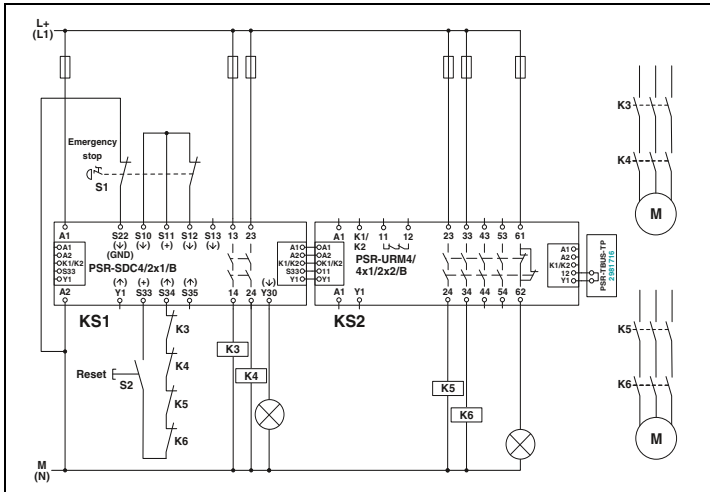

PSR-SDC4 with PSR-URM4-B

Two-channel emergency stop monitoring with manual, monitored start; contact extension via PSR-TBUS; automatic activation: bridge at S33/S35

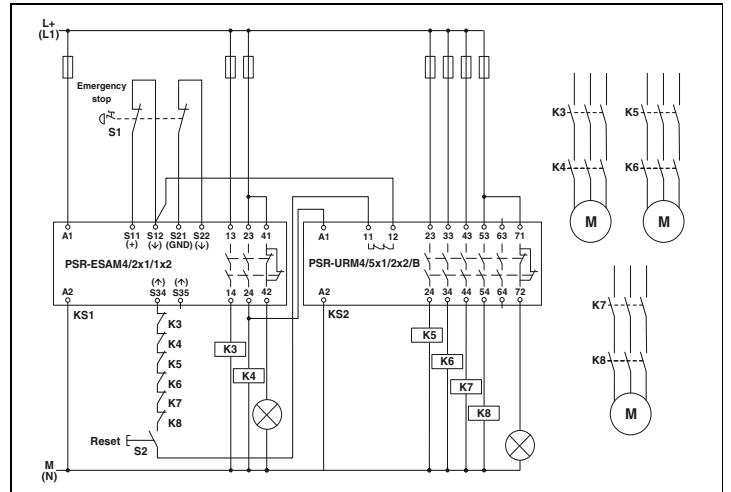

PSR-URM4 and PSR-URM4-B

Two-channel emergency stop monitoring with manual, monitored start; link with PSR-ESAM4/2X1; integration of the confirmation current path into the basic device

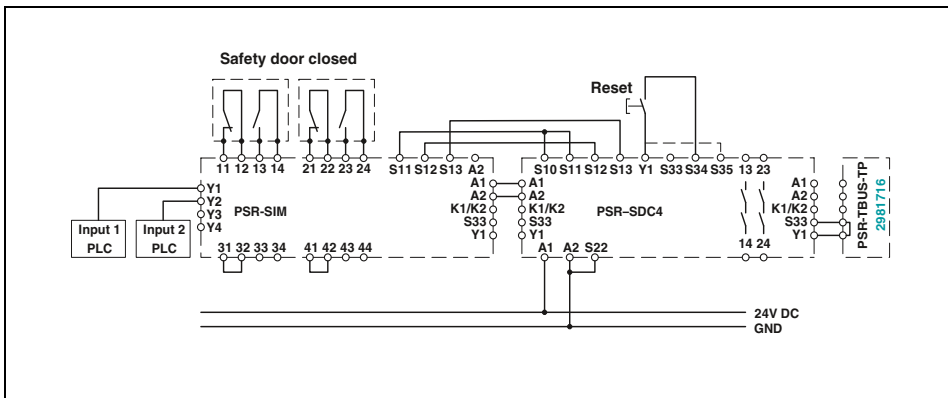

PSR-SIM4 with PSR-SDC4

Safety door monitoring with manual, monitored start; contact extension via interface module; automatic activation: bridge at S33/S35

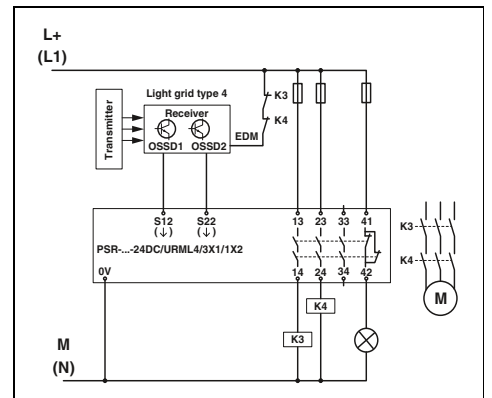

PSR-URML4

Two-channel light grid monitoring; cross-circuit detection via light grid

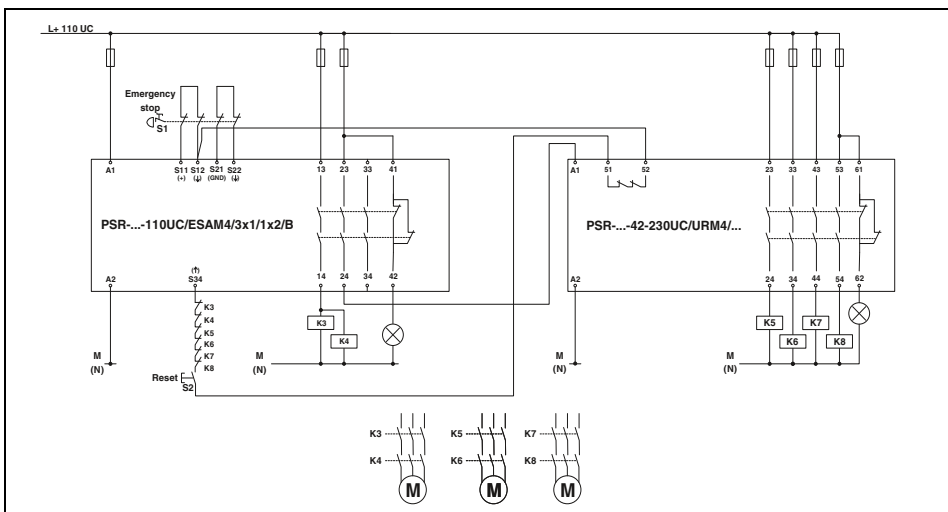

PSR-URM4/42-230UC and PSR-ESAM4/3X1-B

Two-channel emergency stop monitoring with manual, monitored start; link with PSR-ESAM4/3X1-B; integration of the confirmation current path into the basic device

Speed and downtime monitor

- Monitors up to three different speeds plus downtime
- Option to connect encoders (TTL, HTL, SIN/COS) and proximity switches
- Can be parameterized using free PSR-CONF-WIN configuration software
- Up to Cat. 4/PL e according to EN ISO 13849-1, SILCL 3 according to IEC EN 62061

Notes:

Pre-assembled cable adapters are available for connecting the PSR-RSM4 safe speed and downtime monitor to the motor feedback system (of the controller) - Order No. on request.

The necessary PSR-CONF-WIN configuration software can be downloaded free of charge from phoenixcontact.com.



Can be parameterized via software

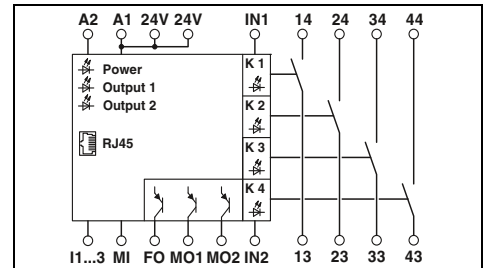

Technical data

Input data	24 V DC
Nominal input voltage U_N	0.85 ... 1.1
Permissible range (with reference to U_N)	100 mA
Typ. current consumption (with reference to U_N)	15 ms
Typical response time	12 ms
Typical release time	1 s
Recovery time	
Output data	4 enabling current paths
Contact type	AgNi10, + 5 μ m Au
Contact material	250 V AC/DC / 100 mV AC/DC
Max./min. switching voltage	5 A, 100 mA (alarm outputs)
Limiting continuous current	6 A / 1 mA
Max./min. inrush current	1 mW
Min. switching power	2 A (24 V (DC13)); 3 A (230 V (AC15))
Switching capacity (3600/h cycles)	6 A gL
Short-circuit protection of the output circuits	
General data	-20 °C ... 55 °C
Ambient temperature range	EN 60664/VDE 0110
Air and creepage distances between the circuits	4 kV / basic insulation, (safe isolation, reinforced insulation, and 6 kV between input circuit and enabling current paths)
Rated surge voltage/insulation	
Screw connection solid / stranded / AWG	0.2 - 2.5 mm ² / 0.2 - 2.5 mm ² / 24 - 12
Spring-cage connection solid / stranded / AWG	0.2 - 1.5 mm ² / 0.2 - 1.5 mm ² / 24 - 16
Dimensions	45 mm / 99 mm / 114.5 mm
W / H / D	45 mm / 112 mm / 114.5 mm
EMC note	Class A product, see page 527

Ordering data

Type	Order No.	Pcs. / Pkt.
PSR-SCP- 24DC/RSM4/4X1	2981538	1
PSR-SPP- 24DC/RSM4/4X1	2981541	1

Accessories

CABLE- 9/8/250/RSM/LENZE	2981826	1
CABLE-15/8/250/RSM/SIMO611D	2981606	1
CABLE-25/8/250/RSM/SIMO611D	2981583	1
PSR-CONF-WIN1.0	2981554	1

Description
Speed and downtime monitor , 2-channel, automatic control with cable adapter or two initiators, activation: manual and automatic
With screw connection
With spring-cage connection
Cable adapter for PSR-RSM4 , cable length 2.5 m, for control unit:
Lenze
Siemens Heidenhain, 15/8-pos.
Siemens Heidenhain, 25/8-pos.
Further types on request
Configuration software for parameterizing the PSR-RSM4 safe downtime and speed monitor, with programming cable

Positively driven coupling relays

- Single-channel control
- Forcibly guided contacts according to EN 50205

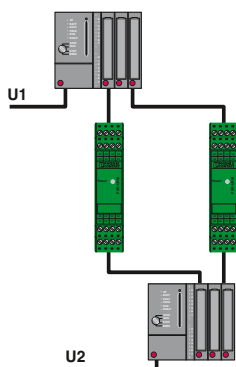

Reliable signal exchange between two systems with confirmation function.



5 N/O contacts, 2 N/C contacts, for $U_N = 24\text{ V AC/DC}$ or 120 V AC/DC

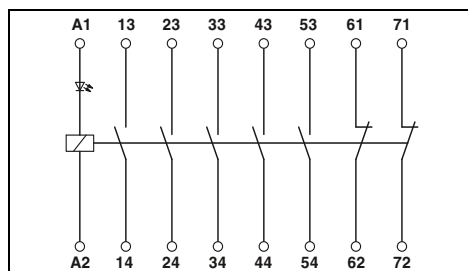

Technical data

Input data	24 V AC/DC	120 V AC/DC
Nominal input voltage U_N	24 V AC/DC	120 V AC/DC
Permissible range (with reference to U_N)	0.8 ... 1.1	0.8 ... 1.1
Typ. current consumption (with reference to U_N)	47 mA	11 mA
Typical response time	20 ms	20 ms
Typical release time	20 ms	20 ms
Output data		
Contact type	5 N/O contacts 2 N/C contacts	
Contact material	AgSnO ₂ , +0.2 μm Au	
Max./min. switching voltage	250 V AC/DC / 15 V AC/DC	
Limiting continuous current	6 A	
Max./min. inrush current	6 A / 25 mA	
Min. switching power	0.4 W	
Switching capacity (360/h cycles)	4 A (24 V DC); 4 A (230 V AC)	
Switching capacity (3600/h cycles)	2.5 A (24 V (DC13)); 3 A (230 V (AC 15))	
General data		
Ambient temperature range	-20 °C ... 55 °C	
Air and creepage distances between the circuits	DIN EN 50178/VDE 0160	
Rated surge voltage/insulation	4 kV / basic insulation	
Screw connection solid / stranded / AWG	0.2 - 2.5 mm ² / 0.2 - 2.5 mm ² / 24 - 12	
Spring-cage connection solid / stranded / AWG	0.2 - 1.5 mm ² / 0.2 - 1.5 mm ² / 24 - 16	
Dimensions	22.5 mm / 99 mm / 114.5 mm	
W / H / D	22.5 mm / 112 mm / 114.5 mm	
EMC note	Class A product, see page 527	

Ordering data

Description	Type	Order No.	Pcs. / Pkt.
Coupling relay , with forcibly guided contacts			
With screw connection for 24 V AC/DC	PSR-SCP- 24UC/URM/5X1/2X2	2963747	1
With spring-cage connection for 24 V AC/DC	PSR-SPP- 24UC/URM/5X1/2X2	2963970	1
Coupling relay , with forcibly guided contacts			
With screw connection for 120 V AC/DC	PSR-SCP-120UC/URM/5X1/2X2	2981402	1
With spring-cage connection for 120 V AC/DC	PSR-SPP-120UC/URM/5X1/2X2	2981415	1

Positively driven coupling relays

- Single-channel control
- Forcibly guided contacts according to EN 50205

Notes:
For marking systems and mounting material see Catalog 5

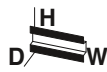

3 N/O contacts, 3 N/C contacts,
for $U_N = 24\text{ V AC/DC}$



5 N/O contacts, 1 N/C contact,
for $U_N = 24\text{ V AC/DC}$

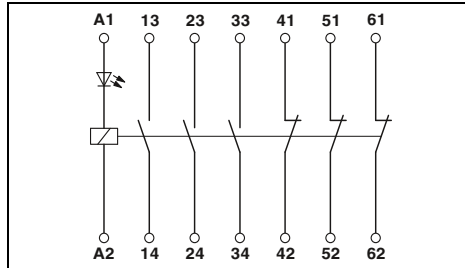

Technical data

Input data	
Nominal input voltage U_N	24 V AC/DC
Permissible range (with reference to U_N)	0.85 ... 1.1
Typ. current consumption (with reference to U_N)	45 mA
Typical response time	15 ms
Typical release time	15 ms
Output data	
Contact type	
3 N/O contacts	
3 N/C contacts	
Contact material	AgSnO ₂
Max./min. switching voltage	250 V AC/DC / 15 V AC/DC
Limiting continuous current	6 A (N/O contact), 6 A (N/C contact)
Max./min. inrush current	6 A / 25 mA
Min. switching power	0.4 W
Switching capacity (360/h cycles)	6 A (24 V DC); 5 A (230 V AC)
Switching capacity (3600/h cycles)	3 A (24 V (DC13)); 3 A (230 V (AC15))
General data	
Ambient temperature range	-20 °C ... 55 °C
Air and creepage distances between the circuits	DIN EN 50178/VDE 0160
Rated surge voltage/insulation	4 kV / basic insulation (safe isolation, reinforced insulation, and 6 kV between the input circuit and the output (13/14, 23/24, 33/34))
Screw connection solid / stranded / AWG	0.2 - 2.5 mm ² / 0.2 - 2.5 mm ² / 24 - 12
Spring-cage connection solid / stranded / AWG	0.2 - 1.5 mm ² / 0.2 - 1.5 mm ² / 24 - 16
Dimensions	22.5 mm / 99 mm / 114.5 mm
W / H / D	22.5 mm / 112 mm / 114.5 mm
EMC note	

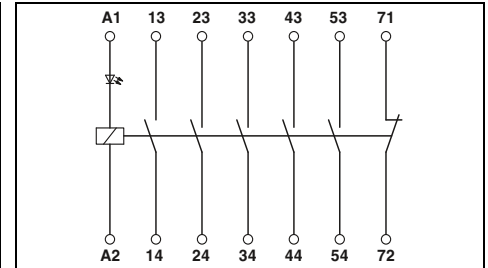

Technical data

Input data	
Nominal input voltage U_N	24 V AC/DC
Permissible range (with reference to U_N)	0.85 ... 1.1
Typ. current consumption (with reference to U_N)	47 mA
Typical response time	20 ms
Typical release time	20 ms
Output data	
Contact type	
5 enabling current paths	
1 signaling current path	
Contact material	AgSnO ₂ , +0.2 μm Au
Max./min. switching voltage	250 V AC/DC / 15 V AC/DC
Limiting continuous current	6 A
Max./min. inrush current	6 A / 25 mA
Min. switching power	0.4 W
Switching capacity (360/h cycles)	4 A (24 V DC); 4 A (230 V AC)
Switching capacity (3600/h cycles)	2.5 A (24 V (DC13)); 3 A (230 V (AC15))
General data	
Ambient temperature range	-20 °C ... 55 °C
Air and creepage distances between the circuits	DIN EN 50178
Rated surge voltage/insulation	4 kV / basic insulation (safe isolation, reinforced insulation, and 6 kV between A1/A2, 53/54, 71/72 and 13/14, 23/24, 33/34, 43/44)
Screw connection solid / stranded / AWG	0.2 - 2.5 mm ² / 0.2 - 2.5 mm ² / 24 - 12
Spring-cage connection solid / stranded / AWG	0.2 - 1.5 mm ² / 0.2 - 1.5 mm ² / 24 - 16
Dimensions	22.5 mm / 99 mm / 114.5 mm
W / H / D	22.5 mm / 112 mm / 114.5 mm
EMC note	

Ordering data

Description	
Coupling relay , with forcibly guided contacts	
With screw connection	
With spring-cage connection	
Coupling relay , with forcibly guided contacts	
With screw connection for 120 V AC/DC	
With spring-cage connection for 120 V AC/DC	
Relay , with forcibly guided contacts, suitable for PR1 relay base	

Type	Order No.	Pcs. / Pkt.
PSR-SCP- 24UC/URM/3X1/3X2	2981839	1
PSR-SPP- 24UC/URM/3X1/3X2	2981842	1

Ordering data

Type	Order No.	Pcs. / Pkt.
PSR-SCP- 24UC/URM/5X1/1X2	2981952	1
PSR-SPP- 24UC/URM/5X1/1X2	2981965	1



4 N/O contacts, 2 N/C contacts,
for $U_N = 24\text{ V AC/DC}$ or 120 V AC/DC



2 PDTs,
for $U_N = 24\text{ V AC/DC}$ or 120 V AC/DC



2 PDTs,
for $U_N = 24\text{ V DC}$

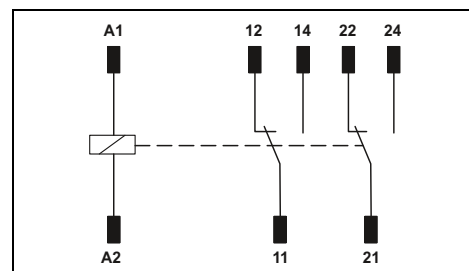
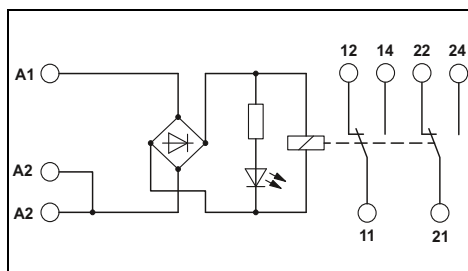
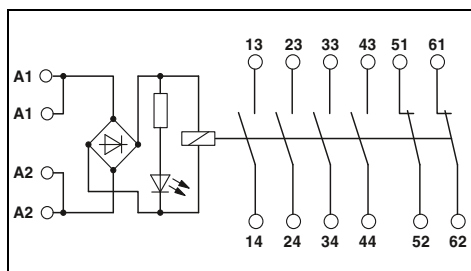

Technical data

Technical data

Technical data

24 V AC/DC	120 V AC/DC
0.8 ... 1.1	0.8 ... 1.1
52 mA	12 mA
10 ms	10 ms
10 ms	10 ms

24 V AC/DC	120 V AC/DC
0.85 ... 1.1	0.85 ... 1.1
30 mA	9 mA
10 ms	10 ms
10 ms	10 ms

24 V DC
-
29 mA
10 ms
4 ms

4 N/O contacts
2 N/C contacts
AgSnO₂
250 V AC/DC / 15 V AC/DC
6 A (total current on request)
6 A / 25 mA
0.4 W
6 A (24 V DC); 5 A (230 V AC)

2 PDTs
AgNi
250 V AC/DC / 15 V AC/DC
5 A (N/O contact), 3.5 A (N/C contact)
6 A / 10 mA
0.24 W
6 A (24 V DC; N/O contact); 3 A (230 V AC; N/O contact)

2 PDTs
AgNi
250 V AC/DC / 15 V
6 A (N/O contact), 6 A (N/C contact)
6 A / 10 mA
0.24 W
6 A (24 V DC; N/O contact); 3 A (230 V AC; N/O contact)

2 A (24 V (DC13); N/O contact); 3 A (230 V (AC15); N/O contact)

2 A (24 V (DC13); N/O contact); 3 A (230 V (AC15); N/O contact)

-20 °C ... 55 °C
DIN EN 50178/VDE 0160
4 kV / basic insulation, (safe isolation, reinforced insulation, and 6 kV between input circuit and enabling current paths)

-20 °C ... 50 °C
DIN EN 50178/VDE 0160
4 kV / basic insulation, (safe isolation, reinforced insulation, and 6 kV between input circuit and enabling current paths)

-25 °C ... 70 °C
DIN EN 50178
6 kV / safe isolation, reinforced insulation

0.2 - 2.5 mm² / 0.2 - 2.5 mm² / 24 - 12
0.2 - 2.5 mm² / 0.2 - 2.5 mm² / 24 - 12
40 mm / 111 mm / 56 mm
40 mm / 111 mm / 56 mm

0.2 - 2.5 mm² / 0.2 - 2.5 mm² / 24 - 12
-
17.5 mm / 75 mm / 60.5 mm
-

-
-
12.6 mm / 29 mm / 25.5 mm
-

Class A product, see page 527

Class A product, see page 527

Ordering data

Ordering data

Ordering data

Type	Order No.	Pcs. / Pkt.
PSR-SCF- 24UC/URM/4X1/2X2	2981444	1
PSR-SPF- 24UC/URM/4X1/2X2	2981457	1
PSR-SCF-120UC/URM/4X1/2X2	2981460	1
PSR-SPF-120UC/URM/4X1/2X2	2981473	1

Type	Order No.	Pcs. / Pkt.
PSR-SCF- 24UC/URM/2X21	2981363	10
PSR-SCF-120UC/URM/2X21	2981376	10

Type	Order No.	Pcs. / Pkt.
REL-SR- 24DC/2X21	2961574	10



Compatible with a range of different higher-level control systems

A high degree of integrity and reliability are the primary demands of the process industry when it comes to systems and components. Phoenix Contact offers highly compact, safe coupling relays for electrical isolation and power adaptation which are tailored to the relevant process control systems and the special requirements of this industry.

More than an idea

By using our own forcibly guided elementary relays, which have been developed according to DIN EN 50205, we can combine high switching capacity, easy and reliable diagnostics, and a very low overall width.

One range – countless possibilities

Built for use in environments with more stringent requirements than the standard, the modules in the PSRmini range have an extensive test and approval package. For example, this means that these components can be operated in particularly corrosive atmospheres, in potentially explosive areas, and under extreme temperature conditions.

Systematic cabling

For projects with a high channel density, it is recommended that a termination carrier is used. Termination carriers are compact solutions for conveniently and smoothly connecting standard DIN rail devices from the entire PSR range to output modules of automation systems.

Safe off – safe on

Both safety-related circuit interrupts and safe switch-on are becoming increasingly important. This particular application is addressed in our portfolio by a special product which is characterized by its extremely comprehensive diagnostic measures on the load side.

Whether emergency shutdown (ESD) or fire and gas (F&G) applications, every safety signal is sent with certainty thanks to the SIL-certified coupling modules from Phoenix Contact.



Select PRS-SIL coupling relay



Select termination carrier TC...



Select controller-specific front adapter and system cable



Solutions also available for MACX and MINI Analog

new

Highly compact, safe coupling relays for failsafe controllers

- SIL coupling relay for safety-related switching off
- 1 enabling current path, 1 digital signal output, 1 diagnostic current path
- Easy proof test
- Active error acknowledgment via A1
- Integrated test pulse filter
- Forcibly guided contacts according to EN 50205
- Up to SIL 3 according to IEC 61508, IEC 61511, and IEC 50156
- Additional approvals: ATEX, IECEx, Class 1 Zone 2, G3, GL



**PSL 3 according to IEC 61508,
1 enabling current path,
1 diagnostic current path**

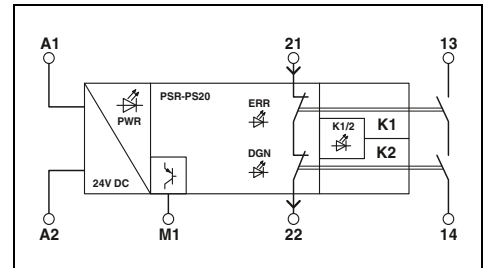

Technical data

Input data	24 V DC -15 % / +10 % typ. 45 mA < 100 ms (when controlled via A1) < 35 ms (when controlled via A1) 500 ms
Rated control supply voltage U_s	
Rated control supply current I_s	
Typical pick-up time	
Typical release time	
Recovery time	
Output data	
Contact type	1 enabling current path 1 confirmation current path AgSnO ₂ (enabling current path) 250 V AC/DC / 20 V AC/DC 6 A (N/O contact), 100 mA (N/C contact) 6 A (N/O contact), 100 mA (N/C contact) / 3 mA 60 mW 6 A gL/gG (N/O contact), 4 A gL/gG (for low-demand applications), 150 mA fast blow (confirmation current path)
Contact material	
Max./min. switching voltage	
Limiting continuous current	
Max./min. inrush current	
Min. switching power	
Short-circuit protection of the output circuits	
Alarm outputs	
Number of outputs	1 (digital, PNP)
Output current	Max. 100 mA
Short-circuit protection	no
Output fuse	150 mA fast blow (signal output)
General data	
Ambient temperature range	-40 °C ... 70 °C (observe derating)
Air and creepage distances between the circuits	DIN EN 50178, EN 60079-15
Rated surge voltage/insulation	Safe isolation, 6 kV reinforced insulation from control circuit, start circuit, confirmation current path, signal output to the enabling current path; 4 kV/basic insulation between all current paths and housing
Screw connection solid / stranded / AWG	0.2 - 2.5 mm ² / 0.2 - 2.5 mm ² / 26 - 12
Dimensions	W / H / D 6.8 mm / 93.1 mm / 102.5 mm

Ordering data

Description	Type	Order No.	Pcs. / Pkt.
Coupling relay for failsafe controllers	PSR-PS20-1NO-1NC-24DC-SC	2700356	1

Highly compact, safe coupling relays for failsafe controllers

- SIL coupling relays for safety-related switching off
- 1 enabling current path, 1 digital signal output
- Easy proof test
- Integrated test pulse filter
- PSR-PS21: active error acknowledgment via A1
- PSR-PS21: plus 1 diagnostic current path
- PSR-PS40: self-monitoring, with device-internal locking
- PSR-PS40: manual or automatic activation
- Forcibly guided contacts according to EN 50205
- Up to SIL 2/3 according to IEC 61508, IEC 61511, and IEC 50156
- Additional approvals: ATEX, IECEx, Class 1 Zone 2, G3, GL



new



new

**SIL 2 according to IEC 61508,
1 enabling current path,
1 diagnostic current path**

**SIL 3 according to IEC 61508,
1 enabling current path,
manual/automatic activation**

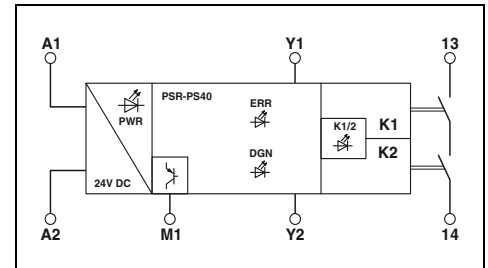
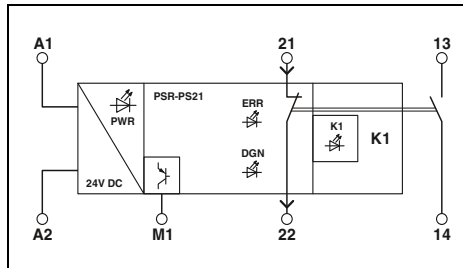

Technical data

Technical data

Input data

Rated control supply voltage U_s
Rated control supply current I_s
Typical pick-up time

Typical release time

Recovery time

Output data

Contact type

Contact material

Max./min. switching voltage

Limiting continuous current

Max./min. inrush current

Min. switching power

Short-circuit protection of the output circuits

24 V DC -15 % / +10 %
typ. 45 mA
< 100 ms (when controlled via A1)

< 35 ms (when controlled via A1)
500 ms

1 enabling current path
1 confirmation current path
AgSnO₂ (enabling current path)
250 V AC/DC / 10 V AC/DC
6 A (N/O contact), 100 mA (N/C contact)
6 A (N/O contact), 100 mA (N/C contact) / 3 mA
30 mW
6 A gL/gG (N/O contact),
4 A gL/gG (for low-demand applications),
150 mA fast blow (confirmation current path)

Alarm outputs

Number of outputs

Output current

Short-circuit protection

Output fuse

General data

Ambient temperature range

Air and creepage distances between the circuits

Rated surge voltage/insulation

1 (digital, PNP)
Max. 100 mA
no
150 mA fast blow (signal output)

-40 °C ... 65 °C (observe derating)
DIN EN 50178, EN 60079-15
4 kV / basic insulation

Screw connection solid / stranded / AWG

Dimensions

W / H / D

0.2 - 2.5 mm² / 0.2 - 2.5 mm² / 26 - 12
6.8 mm / 93.1 mm / 102.5 mm

Ordering data

Ordering data

Description

Coupling relay for failsafe controllers

Type

Order No.

Pcs. / Pkt.

PSR-PS21-1NO-1NC-24DC-SC

2700357

1

Type

Order No.

Pcs. / Pkt.

PSR-PS40-1NO-1DO-24DC-SC

2700398

1

new

Highly compact, safe coupling relay for failsafe controllers

- SIL coupling relay for safety-related switching off
- 1 enabling current path, 1 digital signal output, 1 diagnostic current path
- Easy proof test
- Active error acknowledgment via A1
- Integrated test pulse filter
- 2 internal 5 A fuses
- Forcibly guided contacts according to EN 50205
- Up to SIL 3 according to IEC 61508, IEC 61511, and IEC 50156
- Additional approvals: ATEX, IECEx, Class 1 Zone 2, G3, GL



SIL 3 according to IEC 61508, 1 enabling current path (protected as an option), 1 diagnostic current path

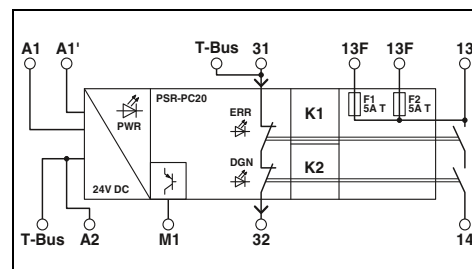

Technical data

Input data	24 V DC -15 % / +10 % typ. 50 mA < 100 ms (when controlled via A1) < 35 ms (when controlled via A1) 500 ms
Rated control supply voltage U_s	
Rated control supply current I_s	
Typical pick-up time	
Typical release time	
Recovery time	
Output data	1 enabling current path 1 confirmation current path AgSnO ₂ (enabling current path) 250 V AC/DC / 20 V AC/DC 6 A (13/14, see derating), 4 A (13F/14, see derating)
Contact type	
Contact material	
Max./min. switching voltage	
Limiting continuous current	
Max./min. inrush current	6 A (N/O contact), 100 mA (N/C contact) / 3 mA
Min. switching power	60 mW
Short-circuit protection of the output circuits	6 A gL/gG (N/O contact), 4 A gL/gG (for low-demand applications), 150 mA fast blow (confirmation current path)
Alarm outputs	1 (digital, PNP) Max. 100 mA no 150 mA fast blow (signal output)
Number of outputs	
Output current	
Short-circuit protection	
Output fuse	
General data	-40 °C ... 70 °C (observe derating) DIN EN 50178, EN 60079-15 Safe isolation, 6 kV reinforced insulation from control circuit, start circuit, confirmation current path, signal output to the enabling current path; 4 kV/basic insulation between all current paths and housing
Ambient temperature range	
Air and creepage distances between the circuits	
Rated surge voltage/insulation	
Screw connection solid / stranded / AWG	0.2 - 2.5 mm ² / 0.2 - 2.5 mm ² / 24 - 12
Spring-cage connection solid / stranded / AWG	0.2 - 1.5 mm ² / 0.2 - 1.5 mm ² / 24 - 16
Dimensions	12.5 mm / 112.2 mm / 114.5 mm
W / H / D	12.5 mm / 112.2 mm / 114.5 mm
	Screw version
	Spring-cage version

Ordering data

Description	Type	Order No.	Pcs. / Pkt.
Coupling relay for failsafe controllers			
With screw connection	PSR-PC20-1NO-1NC-24DC-SC	2700577	1
With spring-cage connection	PSR-PC20-1NO-1NC-24DC-SP	2700578	1

Accessories

DIN rail connector (TBUS) , for bridging the supply voltage, can be snapped onto 35 mm DIN rails according to EN 60715, with UL approval	ME 6,2 TBUS-2 1,5/5-ST-3,81 GN	2869728	10
Mini COMBICON connectors	MC 1,5/ 5-ST-3,81	1803604	50

Highly compact, safe coupling relay for failsafe controllers

- SIL coupling relay for safety-related switching off
- 2 enabling current paths, 1 digital signal output
- Easy proof test
- Active error acknowledgment via A1
- Integrated test pulse filter
- Self-monitoring, with device-internal locking
- Manual or automatic activation
- Forcibly guided contacts according to EN 50205
- Up to SIL 3 according to IEC 61508, IEC 61511, and IEC 50156
- Additional approvals: ATEX, IECEx, Class 1 Zone 2, G3, GL



new

SIL 3 according to IEC 61508, 2 enabling current paths, manual/automatic activation

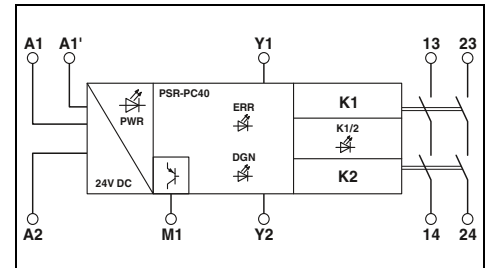

Technical data

Input data	
Rated control supply voltage U_S	24 V DC -15 % / +10 %
Rated control supply current I_S	typ. 75 mA
Typical pick-up time	< 200 ms (when controlled via A1; automatic start)
Typical release time	< 35 ms (when controlled via A1)
Recovery time	500 ms
Output data	
Contact type	2 enabling current paths
Contact material	AgSnO ₂
Max./min. switching voltage	250 V AC/DC / 20 V AC/DC
Limiting continuous current	6 A (N/O contact)
Max./min. inrush current	6 A / 3 mA
Min. switching power	60 mW
Short-circuit protection of the output circuits	6 A gL/gG (N/O contact), 4 A gL/gG (for low-demand applications)
Alarm outputs	
Number of outputs	1 (digital, PNP)
Output current	Max. 100 mA
Short-circuit protection	no
Output fuse	150 mA fast blow (signal output)
General data	
Ambient temperature range	-40 °C ... 70 °C (observe derating)
Air and creepage distances between the circuits	DIN EN 50178, EN 60079-15
Rated surge voltage/insulation	Safe isolation, 6 kV reinforced insulation from control circuit, start circuit, signal output to the enabling current paths, 4 kV/basic insulation between the enabling current paths and between all current paths and housing
Screw connection solid / stranded / AWG	0.2 - 2.5 mm ² / 0.2 - 2.5 mm ² / 24 - 12
Spring-cage connection solid / stranded / AWG	0.2 - 1.5 mm ² / 0.2 - 1.5 mm ² / 24 - 16
Dimensions	12.5 mm / 112.2 mm / 114.5 mm
W / H / D	12.5 mm / 112.2 mm / 114.5 mm
	Screw version
	Spring-cage version

Ordering data

Description	Type	Order No.	Pcs. / Pkt.
Coupling relay for failsafe controllers			
With screw connection	PSR-PC40-2NO-1DO-24DC-SC	2700588	1
With spring-cage connection	PSR-PC40-2NO-1DO-24DC-SP	2700589	1

new

Highly compact, safe coupling relay for failsafe controllers

- SIL coupling relay for safety-related switch-on
- 1 enabling current path, 1 digital signal output
- Can be used in low-demand applications
- Easy proof test
- Active error acknowledgment via A1
- Integrated test pulse filter
- Up to SIL 3 according to IEC 61508 and IEC 61511
- Additional approvals: ATEX, IECEx, Class 1 Zone 2, GL



Coupling relay for safe switch-on certified according to SIL 3

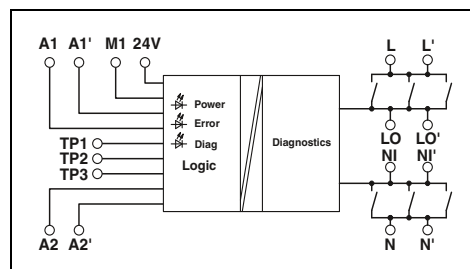

Technical data

Input data	
Nominal input voltage U_N	24 V DC -15 %; +10 % (A1/A2 and 24V/A2)
Permissible range (with reference to U_N)	0.85 ... 1.1
Typ. current consumption (with reference to U_N)	65 mA (A1/A2) / 15 mA (24V/A2; depending on load M1 +100 mA)
Typical pick-up time	30 ms (when controlled via A1)
Typical release time	30 ms (when controlled via A1)
Recovery time	1 s
Output data	
Contact type	1 enabling current path
Contact material	AgNi, gold-flashed
Max./min. switching voltage	250 V AC / 15 V AC/DC
Limiting continuous current	5 A (N/O contact)
Max./min. inrush current	5 A / 100 mA
Min. switching power	1.5 W
Short-circuit protection of the output circuits	6 A gL/gG
Alarm outputs	
Number of outputs	1 (digital)
Output current	Max. 100 mA
Short-circuit protection	no
Output fuse	150 mA fast blow (signal output)
General data	
Ambient temperature range	-20 °C ... 55 °C
Air and creepage distances between the circuits	DIN EN 50178
Rated surge voltage/insulation	6 kV/safe isolation (through protective impedance)
Screw connection solid / stranded / AWG	0.2 - 2.5 mm ² / 0.2 - 2.5 mm ² / 24 - 12
Spring-cage connection solid / stranded / AWG	0.2 - 1.5 mm ² / 0.2 - 1.5 mm ² / 24 - 16
Dimensions	17.5 mm / 112.2 mm / 114.5 mm
W / H / D	17.5 mm / 117.4 mm / 114.5 mm
	Screw version
	Spring-cage version

Ordering data

Description	Type	Order No.	Pcs. / Pkt.
Coupling relay for failsafe controllers			
With screw connection	PSR-PC50-1NO-1DO-24DC-SC	2904664	1
With spring-cage connection	PSR-PC50-1NO-1DO-24DC-SP	2904665	1

Emergency stop coupling relay for failsafe controllers

- SIL coupling relay for safety-related switching off
- 1 enabling current path, 1 confirmation current path
- Can be used in high- and low-demand applications
- Easy proof test
- Integrated test pulse filter
- Replaceable fuse
- Forcibly guided contacts according to EN 50205
- Up to SIL 3 according to IEC 61508, IEC 61511, and IEC 50156

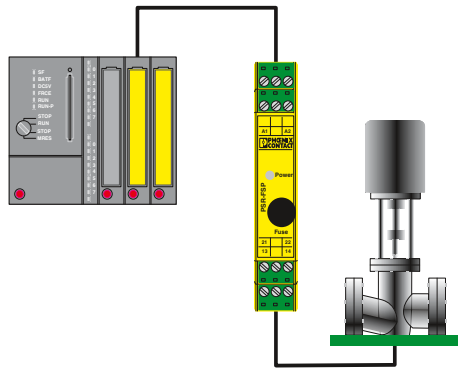

Example of electrical isolation of a safety PLC output from the field.



SIL 3 according to IEC 61508, 1 protected enabling current path

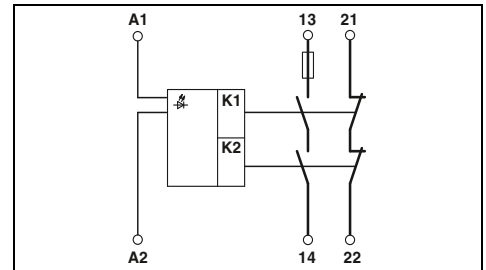

Notes:
Can be used for system cabling with the termination carrier. For further information, see page 75.

Technical data

Input data	
Nominal input voltage U_N	24 V DC
Permissible range (with reference to U_N)	0.85 ... 1.1
Typ. current consumption (with reference to U_N)	55 mA
Typical response time	50 ms
Typical release time	50 ms
Recovery time	1 s
Output data	
Contact type	1 undelayed enabling current path 1 undelayed confirmation current path
Contact material	AgCuNi, +0.2 μm Au
Max./min. switching voltage	250 V AC/DC / 15 V AC/DC
Limiting continuous current	5 A (N/O contact, observe derating), 100 mA (N/C contact)
Max./min. inrush current	5 A / 5 mA
Min. switching power	75 mW
Switching capacity (3600/h cycles)	5 A (24 V (DC13)); 5 A (230 V (AC15))
Short-circuit protection of the output circuits	5 A T (fuse)
General data	
Ambient temperature range	-20 °C ... 55 °C
Air and creepage distances between the circuits	DIN EN 50178
Rated surge voltage/insulation	6 kV / safe isolation, reinforced insulation
Screw connection solid / stranded / AWG	0.2 - 2.5 mm ² / 0.2 - 2.5 mm ² / 24 - 12
Spring-cage connection solid / stranded / AWG	0.2 - 1.5 mm ² / 0.2 - 1.5 mm ² / 24 - 16
Dimensions	17.5 mm / 99 mm / 114.5 mm
W / H / D	17.5 mm / 112 mm / 114.5 mm
EMC note	Class A product, see page 527

Ordering data

Description	Type	Order No.	Pcs. / Pkt.
Emergency stop coupling relay for failsafe controllers in process engineering, with protected enabling current path			
With screw connection	PSR-SCP- 24DC/FSP/1X1/1X2	2981978	1
With spring-cage connection	PSR-SPP- 24DC/FSP/1X1/1X2	2981981	1

Emergency stop coupling relays for failsafe controllers

- SIL coupling relays for safety-related switching off
- 2 enabling current paths, 1 confirmation current path
- Can be used in high- and low-demand applications
- Easy proof test
- Integrated test pulse filter
- Forcibly guided contacts according to EN 50205
- Up to SIL 2/3 according to IEC 61508, IEC 61511, and IEC 50156



SIL 2 according to IEC 61508, 2 enabling current paths



SIL 3 according to IEC 61508, 2 enabling current paths

Notes:
Can be used for system cabling with the termination carrier. For further information, see page 75.

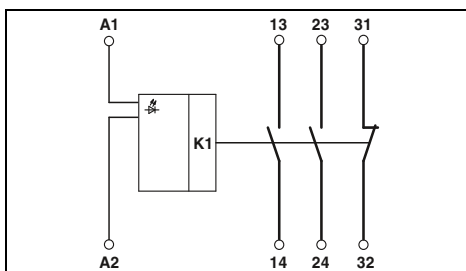

Technical data

Input data	
Nominal input voltage U_N	24 V DC
Permissible range (with reference to U_N)	0.85 ... 1.1
Typ. current consumption (with reference to U_N)	55 mA
Typical response time	50 ms
Typical release time	50 ms
Recovery time	1 s
Output data	
Contact type	2 undelayed enabling current paths 1 undelayed confirmation current path
Contact material	AgCuNi, +0.2 µm Au
Max./min. switching voltage	250 V AC/DC / 15 V AC/DC
Limiting continuous current	5 A (N/O contact), 100 mA (N/C contact)
Max./min. inrush current	5 A / 5 mA
Min. switching power	75 mW
Switching capacity (3600/h cycles)	5 A (24 V (DC13)); 5 A (230 V (AC15))
Short-circuit protection of the output circuits	10 A gL/gG (N/O contact), 6 A gL/gG (N/C contact)
General data	
Ambient temperature range	-20 °C ... 55 °C
Air and creepage distances between the circuits	DIN EN 50178/VDE 0160
Rated surge voltage/insulation	6 kV / safe isolation, reinforced insulation
Screw connection solid / stranded / AWG	0.2 - 2.5 mm ² / 0.2 - 2.5 mm ² / 24 - 12
Spring-cage connection solid / stranded / AWG	0.2 - 1.5 mm ² / 0.2 - 1.5 mm ² / 24 - 16
Dimensions	17.5 mm / 99 mm / 114.5 mm
W / H / D	17.5 mm / 112 mm / 114.5 mm
EMC note	Class A product, see page 527

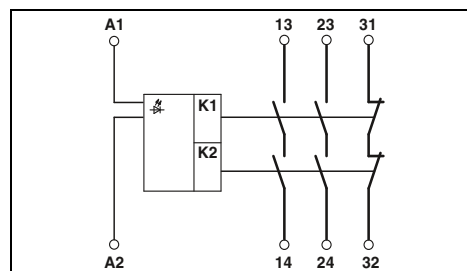

Technical data

Input data	
Nominal input voltage U_N	24 V DC
Permissible range (with reference to U_N)	0.85 ... 1.1
Typ. current consumption (with reference to U_N)	55 mA
Typical response time	50 ms
Typical release time	50 ms
Recovery time	1 s
Output data	
Contact type	2 undelayed enabling current paths 1 undelayed confirmation current path
Contact material	AgCuNi, +0.2 µm Au
Max./min. switching voltage	250 V AC/DC / 15 V AC/DC
Limiting continuous current	5 A (N/O contact), 100 mA (N/C contact)
Max./min. inrush current	5 A / 5 mA
Min. switching power	75 mW
Switching capacity (3600/h cycles)	5 A (24 V (DC13)); 5 A (230 V (AC15))
Short-circuit protection of the output circuits	10 A gL/gG (N/O contact), 6 A gL/gG (N/C contact)
General data	
Ambient temperature range	-20 °C ... 55 °C
Air and creepage distances between the circuits	DIN EN 50178/VDE 0160
Rated surge voltage/insulation	6 kV / safe isolation, reinforced insulation
Screw connection solid / stranded / AWG	0.2 - 2.5 mm ² / 0.2 - 2.5 mm ² / 24 - 12
Spring-cage connection solid / stranded / AWG	0.2 - 1.5 mm ² / 0.2 - 1.5 mm ² / 24 - 16
Dimensions	17.5 mm / 99 mm / 114.5 mm
W / H / D	17.5 mm / 112 mm / 114.5 mm
EMC note	Class A product, see page 527

Ordering data

Description	Type	Order No.	Pcs. / Pkt.
Emergency stop coupling relay, for failsafe controllers, two enabling current paths, SIL 2 according to IEC 61508			
With screw connection	PSR-SCP- 24DC/FSP2/2X1/1X2	2986575	1
With spring-cage connection	PSR-SPP- 24DC/FSP2/2X1/1X2	2986588	1
Emergency stop coupling relay, for failsafe controllers, two enabling current paths, SIL 3 according to IEC 61508			
With screw connection	PSR-SCP- 24DC/FSP2/2X1/1X2	2986960	1
With spring-cage connection	PSR-SPP- 24DC/FSP2/2X1/1X2	2986957	1

Ordering data

Description	Type	Order No.	Pcs. / Pkt.
Emergency stop coupling relay, for failsafe controllers, two enabling current paths, SIL 3 according to IEC 61508			
With screw connection	PSR-SCP- 24DC/FSP2/2X1/1X2	2986960	1
With spring-cage connection	PSR-SPP- 24DC/FSP2/2X1/1X2	2986957	1

Safe coupling relay for emergency stop and safety door monitoring

- SIL coupling relay for safety-related switching off
- single- and two-channel control
- 2 enabling current paths, 1 confirmation current path
- Manual and automatic activation in a single device
- With inrush current reduction, therefore suitable for coupling to failsafe controllers
- Forcibly guided contacts according to EN 50205
- Up to SIL 3 according to IEC 61508 and IEC 61511



Manual or automatic activation, also suitable for failsafe PLC

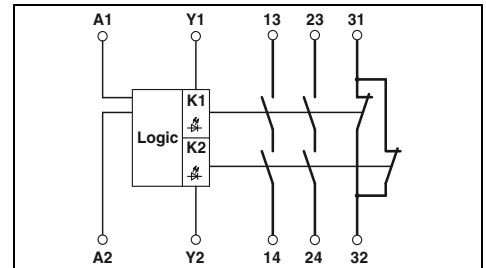

Technical data

Input data	
Nominal input voltage U_N	24 V DC
Permissible range (with reference to U_N)	0.85 ... 1.1
Typ. current consumption (with reference to U_N)	50 mA DC
Typical response time	60 ms (automatic/manual start)
Typical release time	20 ms
Recovery time	approx. 1 s
Output data	
Contact type	
Contact material	
Max./min. switching voltage	250 V AC/DC / 10 V
Limiting continuous current	6 A (N/O contact/N/C contact, high demand), 4 A (N/O contact/N/C contact, low demand)
Max./min. inrush current	6 A / 10 mA
Min. switching power	0.2 W
Switching capacity (360/h cycles)	5 A (24 V DC); 5 A (230 V AC)
Switching capacity (3600/h cycles)	5 A (24 V (DC13)); 5 A (230 V (AC 15))
Short-circuit protection of the output circuits	6 A gL/gG NEOZED (high demand), 4 A gL/gG NEOZED (low demand)
General data	
Ambient temperature range	
Air and creepage distances between the circuits	-20 °C ... 55 °C
Rated surge voltage/insulation	DIN EN 50178/VDE 0160 6 kV / safe isolation, reinforced insulation
Screw connection solid / stranded / AWG	
Spring-cage connection solid / stranded / AWG	0.2 - 2.5 mm ² / 0.2 - 2.5 mm ² / 24 - 12
Dimensions	0.2 - 1.5 mm ² / 0.2 - 1.5 mm ² / 24 - 16
	22.5 mm / 99 mm / 114.5 mm
W / H / D	22.5 mm / 112 mm / 114.5 mm

Technical data		
24 V DC		
0.85 ... 1.1		
50 mA DC		
60 ms (automatic/manual start)		
20 ms		
approx. 1 s		
2 enabling current paths		
1 signaling current path (type B according to EN 50205)		
AgSnO ₂ gold-flashed		
250 V AC/DC / 10 V		
6 A (N/O contact/N/C contact, high demand),		
4 A (N/O contact/N/C contact, low demand)		
6 A / 10 mA		
0.2 W		
5 A (24 V DC); 5 A (230 V AC)		
5 A (24 V (DC13)); 5 A (230 V (AC 15))		
6 A gL/gG NEOZED (high demand),		
4 A gL/gG NEOZED (low demand)		
-20 °C ... 55 °C		
DIN EN 50178/VDE 0160		
6 kV / safe isolation, reinforced insulation		
0.2 - 2.5 mm ² / 0.2 - 2.5 mm ² / 24 - 12		
0.2 - 1.5 mm ² / 0.2 - 1.5 mm ² / 24 - 16		
22.5 mm / 99 mm / 114.5 mm		
22.5 mm / 112 mm / 114.5 mm		

Ordering data

Description	
Process technology, emergency stop and safety door monitoring, single-channel, activation: manual and automatic	
With screw connection	
With spring-cage connection	

Type	Order No.	Pcs. / Pkt.
PSR-SCP- 24DC/ESP4/2X1/1X2	2981020	1
PSR-SPP- 24DC/ESP4/2X1/1X2	2981017	1

Termination carriers for coupling relays

- Convenient and faultless connection using pre-assembled system cables
- 1:1 signal allocation to a 37-pos. D-SUB connector
- Redundant power supply, decoupled from diode and protected against polarity reversal
- Integrated undervoltage detection with separate signal path



Termination carrier for up to 16 PSR-FSP modules



Termination carrier for up to 16 PSR-ETP modules

Notes:
Cable and jumper plugs are not supplied as standard with the termination carriers.
PSRmini – termination carriers for highly compact coupling relays can be found at phoenixcontact.net/products .

EAC
Housing width 304 mm

Technical data

D-SUB pin strip
37
< 50 V DC (per signal/channel)
1 A (signal/channel)
50 V
2
II
-20 °C ... 60 °C
V0
304 / 170 / 160 mm
Class A product, see page 527

General data
Connection to the control system level
Number of positions
Max. operating voltage
Max. permissible current
Rated insulation voltage
Pollution degree
Surge voltage category
Ambient temperature range
Inflammability class according to UL 94
Dimensions W / H / D
EMC note
Supply
Input voltage range
Redundant supply
Polarization and surge protection
Fuse
Status indication
Undervoltage monitoring

21.1 V DC ... 26.4 V DC
Yes, decoupled from diodes
Yes
2.5 A on PCB, slow-blow (replaceable)
2 x red LED (error)
2 x green LEDs (PWR1 and PWR2)
At < 18 V (alarm contact, 1 N/O contact)

Ordering data

Type	Order No.	Pcs. / Pkt.
TC-2D37SUB-DO16-ESD-AR-UNI	2902913	1

Description
Termination carrier for 16 coupling relays For safety-related switching off
For safety-related switching on

Accessories

TC-C-PSR3-SC-A10000A20000	2903389	16
TC-C-PSR3-SC-A10000A23132	2903390	16
TC-C-PTSM-50-00000000J1J1	2903388	8

Cable set without use of confirmation contact, suitable for PSR-FSP/Order No.: 2981978
Cable set with use of confirmation contact, suitable for PSR-FSP/Order No.: 2986960 and 2986575
Jumper plug for occupying unused module slots, suitable for PSR-FSP/Order No.: 2986960 and 2986575
Cable set

Housing width 304 mm

Technical data

D-SUB pin strip
37
< 50 V DC (per signal/channel)
1 A (signal/channel)
50 V
2
II
-20 °C ... 60 °C
V0
304 / 170 / 160 mm
Class A product, see page 527

21.1 V DC ... 26.4 V DC
Yes, decoupled from diodes
Yes
2.5 A on PCB, slow-blow (replaceable)
2 x red LED (error)
2 x green LEDs (PWR1 and PWR2)
At < 18 V (alarm contact, 1 N/O contact)

Ordering data

Type	Order No.	Pcs. / Pkt.
TC-2D37SUB-DO16-F&G-AR-UNI	2902914	1

Accessories

TC-C-PCX3-SC-A100V+A20000	2906003	16
---------------------------	---------	----

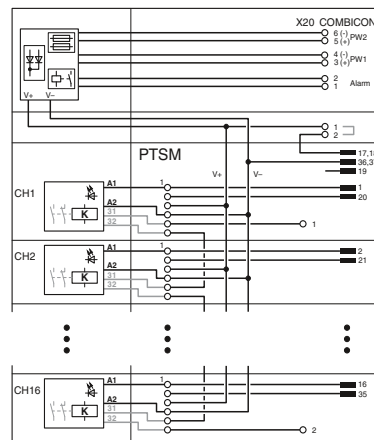

Connection scheme TC-2D37SUB-DO16-ESD-AR-UNI

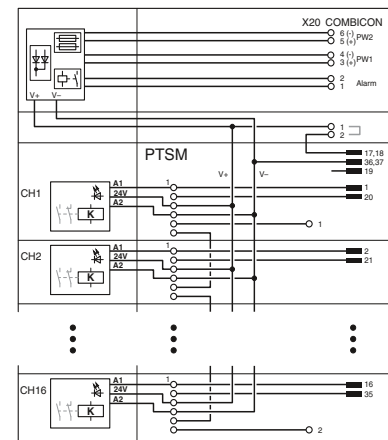

Connection scheme TC-2D37SUB-DO16-F&G-AR-UNI

Applications

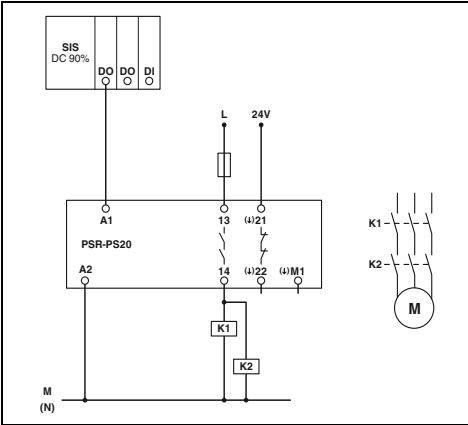

PSR-PS20

Single-channel control via A1 with diagnostic supply voltage applied to contact 21; suitable for low-demand applications

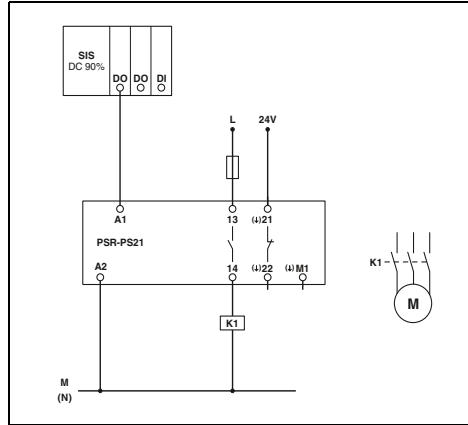

PSR-PS21

Single-channel control via A1 with diagnostic supply voltage applied to contact 21; suitable for low-demand applications

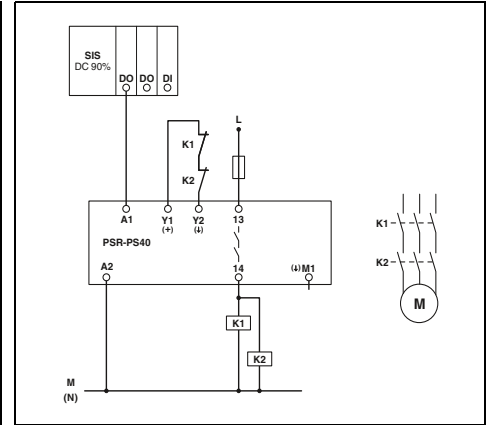

PSR-PS40

Single-channel control via A1 with automatic activation; suitable for low-demand applications

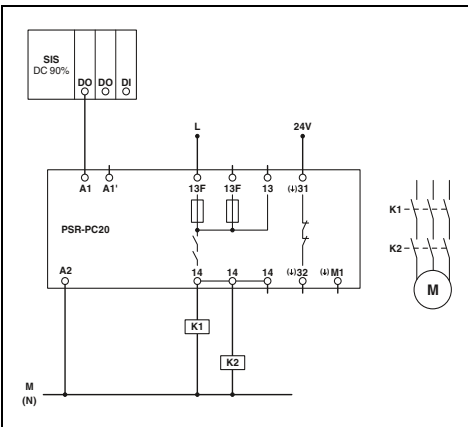

PSR-PC20

Single-channel control via A1 with diagnostic supply voltage applied to contact 31; suitable for low-demand applications

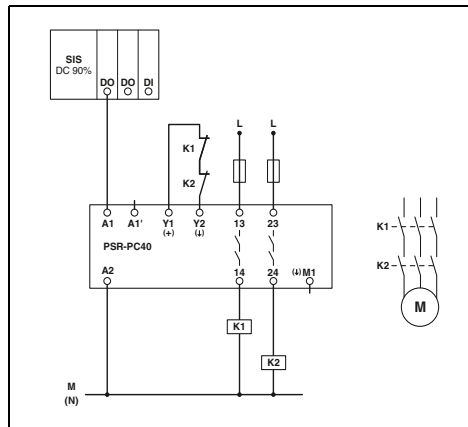

PSR-PC40

Single-channel control via A1 with automatic activation; suitable for low-demand applications

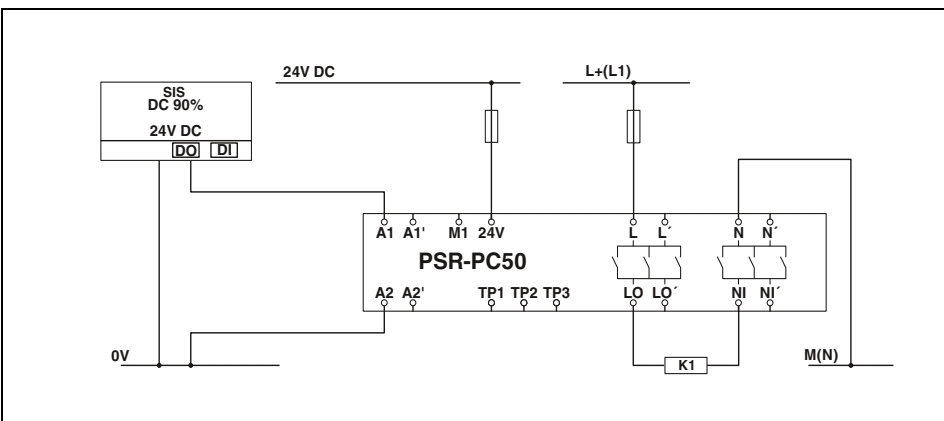

PSR-PC50

Single-channel control via A1 with diagnostic supply voltage applied; suitable for low-demand applications

Applications

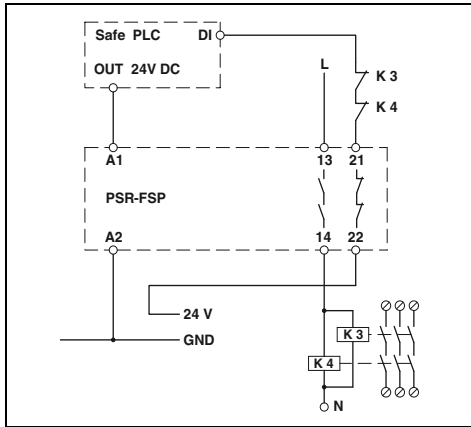

PSR-FSP/1X1

Single-channel connection to failsafe controller with confirmation current path integration; suitable for high-demand applications

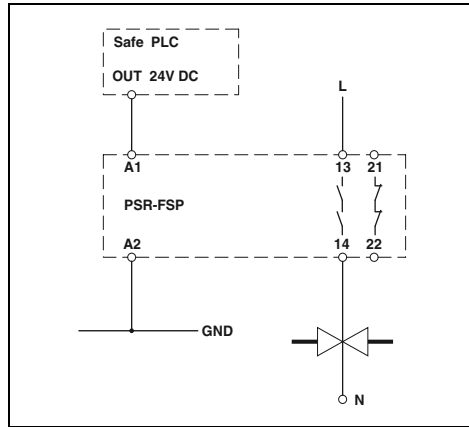

PSR-FSP/1X1

Single-channel connection to failsafe controllers without confirmation current path integration; suitable for low-demand applications

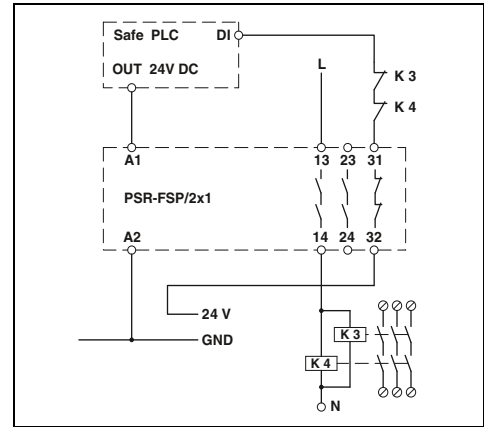

PSR-FSP/2X1

Single-channel connection to failsafe controller with confirmation current path integration; suitable for high-demand applications

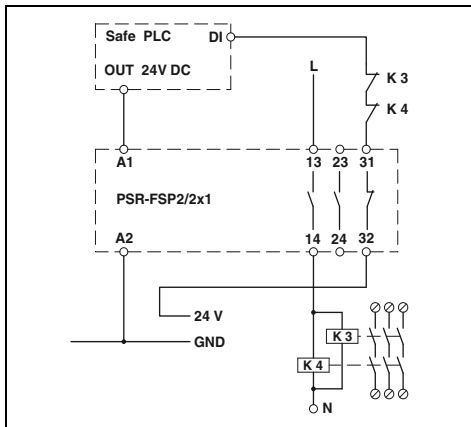

PSR-FSP2/2X1

Single-channel connection to failsafe controller with confirmation current path integration; suitable for high-demand applications

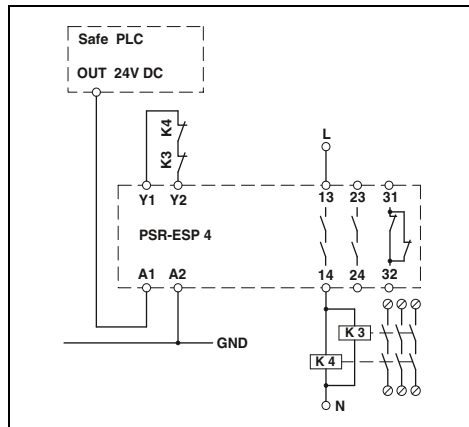

PSR-ESP4

Single-channel connection to failsafe controller with automatic start

Configurable safety modules

TRISAFE-S – master module

- Freely configurable safety module for monitoring emergency stop, safety doors, light grids, etc.
- With 20 safe inputs, 4 safe outputs, 4 alarm outputs, and 2 clock outputs on an overall width of just 67.5 mm
- Easily graphically configurable with the SAFECONF software
- Quick commissioning by means of comprehensive simulation and test functions
- Option for connecting fieldbus gateways for diagnostics and signaling functions
- incl. IFS-CONFSTICK memory stick for easy storage and backup of the configuration
- Up to Cat. 4/PL e according to EN ISO 13849-1, SILCL 3 according to IEC EN 62061

Notes:
The necessary SAFECONF configuration software can be downloaded free of charge from phoenixcontact.com .
Further information on the SAFECONF configuration software can be found on page 88
Further information on fieldbus gateways can be found in the "Motor management" section of Catalog 7 or at phoenixcontact.net/products .



Configurable safety module, cannot be extended

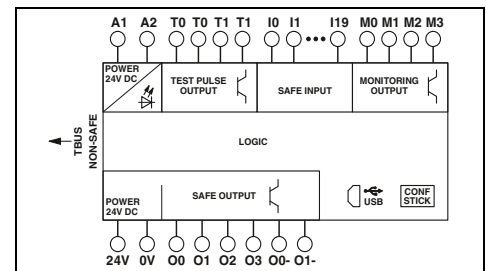

Module data	
Nominal input voltage U_N	24 V DC
Permissible range (with reference to U_N)	0.85 ... 1.1
Typ. current consumption (with reference to U_N)	110 mA
Max. response time	< 30 ms
Interfaces	USB
Input data	
Number of safe inputs	20
Nominal voltage	24 V DC
Output data	
Safe semiconductor outputs	4 (Cat.4 / ISO 13849)
Nominal voltage	24 V DC
Limiting continuous current	2 A (see derating curve)
Ground switching outputs	2
Clock outputs	2
Alarm outputs	4
General data	
Ambient temperature range	-20 °C ... 55 °C
Screw connection solid / stranded / AWG	0.2 - 2.5 mm ² / 0.2 - 2.5 mm ² / 24 - 12
Spring-cage connection solid / stranded / AWG	0.2 - 1.5 mm ² / 0.2 - 1.5 mm ² / 24 - 16
Dimensions	67.5 mm / 99 mm / 114.5 mm
W / H / D	67.5 mm / 112 mm / 114.5 mm
EMC note	Class A product, see page 527

Technical data

24 V DC
0.85 ... 1.1
110 mA
< 30 ms
USB
20
24 V DC
4 (Cat.4 / ISO 13849)
24 V DC
2 A (see derating curve)
2
2
4
-20 °C ... 55 °C
0.2 - 2.5 mm ² / 0.2 - 2.5 mm ² / 24 - 12
0.2 - 1.5 mm ² / 0.2 - 1.5 mm ² / 24 - 16
67.5 mm / 99 mm / 114.5 mm
67.5 mm / 112 mm / 114.5 mm
Class A product, see page 527

Description
Freely configurable safety module , for monitoring emergency stop, safety doors, light grids, etc., with 20 safe inputs and 4 safe outputs, 4 signaling and 2 cycle outputs
With screw connection
With spring-cage connection

Ordering data

Type	Order No.	Pcs. / Pkt.
PSR-SCP- 24DC/TS/S	2986229	1
PSR-SPP- 24DC/TS/S	2986232	1

Configuration software (single license) for the PSR-TRISAFE system
Starter kit for the PSR-TRISAFE safety module, consists of PSR-TRISAFE demo board (with inputs and outputs), SAFECONF software, USB connecting cable (3 m), power supply with international plug adapters, quick start guide
Multifunctional memory module for the INTERFACE system
PSR-TBUS DIN rail connector , for supplying/controlling/monitoring (depending on the module)

Accessories

SAFECONF	2986119	1
PSR-TRISAFE STARTER KIT	2986300	1
IFS-CONFSTICK	2986122	1
PSR-TBUS	2890425	50

TRISAFE-M – master module that can be safely extended

- Freely configurable safety module for monitoring emergency stop, safety doors, light grids, etc.
- Safe and standard extension via INTERFACE DIN rail TBUS
- With 20 safe inputs, 4 safe outputs, 4 alarm outputs, and 2 clock outputs on an overall width of just 67.5 mm
- Easily graphically configurable with the SAFECONF software
- Option for connecting fieldbus gateways for diagnostics and signaling functions
- incl. IFS-CONFSTICK memory stick for easy storage and backup of the configuration
- incl. PSR-TBUS connector (DIN rail connector) for adapting safe extension modules
- Up to Cat. 4/PL e according to EN ISO 13849-1, SILCL 3 according to IEC EN 62061

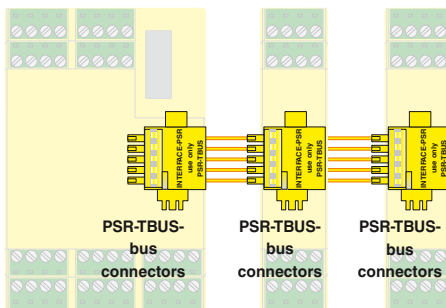

PSR-TBUS DIN rail connectors are used for cross-wiring between the modules.



PL
EN ISO 13849



Configurable safety module, can be extended

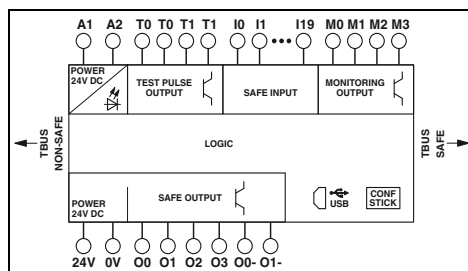

Notes:
For extension modules for PSR-TRISAFE modular, see page 80 onwards
The necessary SAFECONF configuration software can be downloaded free of charge from phoenixcontact.com.
Further information on the SAFECONF configuration software can be found on page 88
Further information on fieldbus gateways can be found in the "Motor management" section of Catalog 7 or at phoenixcontact.net/products.

Module data	
Nominal input voltage U_N	24 V DC
Permissible range (with reference to U_N)	0.85 ... 1.1
Typ. current consumption (with reference to U_N)	110 mA
Max. response time	< 30 ms
Interfaces	USB
Input data	
Number of safe inputs	20
Nominal voltage	24 V DC
Output data	
Safe semiconductor outputs	4 (Cat.4 / ISO 13849)
Nominal voltage	24 V DC
Limiting continuous current	2 A (see derating curve)
Ground switching outputs	2
Clock outputs	2
Alarm outputs	4
General data	
Ambient temperature range	-20 °C ... 55 °C
Screw connection solid / stranded / AWG	0.2 - 2.5 mm ² / 0.2 - 2.5 mm ² / 24 - 12
Spring-cage connection solid / stranded / AWG	0.2 - 1.5 mm ² / 0.2 - 1.5 mm ² / 24 - 16
Dimensions	67.5 mm / 99 mm / 114.5 mm
W / H / D	67.5 mm / 112 mm / 114.5 mm
EMC note	Class A product, see page 527

Technical data

24 V DC
0.85 ... 1.1
110 mA
< 30 ms
USB
20
24 V DC
4 (Cat.4 / ISO 13849)
24 V DC
2 A (see derating curve)
2
2
4
-20 °C ... 55 °C
0.2 - 2.5 mm ² / 0.2 - 2.5 mm ² / 24 - 12
0.2 - 1.5 mm ² / 0.2 - 1.5 mm ² / 24 - 16
67.5 mm / 99 mm / 114.5 mm
67.5 mm / 112 mm / 114.5 mm
Class A product, see page 527

Ordering data

Type	Order No.	Pcs. / Pkt.
PSR-SCP- 24DC/TS/M	2986012	1
PSR-SPP- 24DC/TS/M	2986025	1

Accessories

Accessories	Order No.	Pcs. / Pkt.
SAFECONF	2986119	1
PSR-TRISAFE STARTER KIT	2986300	1
IFS-CONFSTICK	2986122	1
PSR-TBUS	2890425	50

Description
Freely configurable master module , for monitoring emergency stops, safety doors, light grids, etc., with 20 safe inputs and 4 safe outputs, 4 alarm outputs and 2 clock outputs, safe and standard extension, including memory stick and PSR-TBUS DIN rail connector
With screw connection
With spring-cage connection

Configuration software (single license) for the PSR-TRISAFE system
Starter kit for the PSR-TRISAFE safety module, consists of PSR-TRISAFE demo board (with inputs and outputs), SAFECONF software, USB connecting cable (3 m), power supply with international plug adapters, quick start guide
Multifunctional memory module for the INTERFACE system
PSR-TBUS DIN rail connector , for supplying/controlling/monitoring (depending on the module)

Configurable safety modules

TRISAFE – extension modules

- I/O extension for PSR-TRISAFE-M
- 8 safe digital inputs
- 4 safe digital outputs or 4 additional digital inputs (that can be configured using SAFECONF)
- 2 alarm outputs or 2 clock outputs (that can be configured using SAFECONF)
- Narrow 22.5 mm housing
- Including PSR-TBUS DIN rail connector for adapting to the PSR-TRISAFE-M master module
- Up to Cat. 4/PL e according to EN ISO 13849-1, SILCL 3 according to IEC EN 62061



Extension module with 8 safe inputs, plus 4 safe inputs or outputs

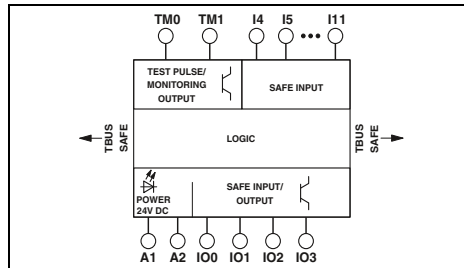

Technical data

Module data	
Nominal input voltage U_N	24 V DC (A1 / A2)
Permissible range (with reference to U_N)	0.85 ... 1.1
Typ. current consumption (with reference to U_N)	100 mA
Max. response time	< 30 ms
Input data	
Number of safe inputs	12 (of which 4 can be configured as input or output)
Nominal voltage	24 V DC
Output data	
Safe semiconductor outputs	4 (if the four parameterizable inputs/outputs are used as outputs)
Nominal voltage	24 V DC
Limiting continuous current	4x 0.5 A (sekbpse derating curve)
Contact type	-
Contact material	-
Max./min. switching voltage	-
Limiting continuous current	-
Max./min. inrush current	-
Min. switching power	-
Short-circuit protection of the output circuits	-
Response time	-
Cycle/alarm outputs	2
Alarm outputs	-
General data	
Ambient temperature range	-20 °C ... 55 °C
Screw connection solid / stranded / AWG	0.2 - 2.5 mm ² / 0.2 - 2.5 mm ² / 24 - 12
Spring-cage connection solid / stranded / AWG	0.2 - 1.5 mm ² / 0.2 - 1.5 mm ² / 24 - 16
Dimensions	22.5 mm / 99 mm / 114.5 mm
W / H / D	22.5 mm / 112 mm / 114.5 mm
EMC note	Class A product, see page 527

Ordering data

Description	Type	Order No.	Pcs. / Pkt.
Extension module , 8 safe inputs and 4 safe freely parameterizable channels (as safe inputs or outputs), including PSR-TBUS connector			
With screw connection	PSR-SCP- 24DC/TS/SDI8/SDIO4	2986038	1
With spring-cage connection	PSR-SPP- 24DC/TS/SDI8/SDIO4	2986041	1

Accessories

PSR-TBUS DIN rail connector, for supplying/controlling/monitoring (depending on the module)	PSR-TBUS	2890425	50
---	----------	---------	----



Extension module with 4 safe relay outputs

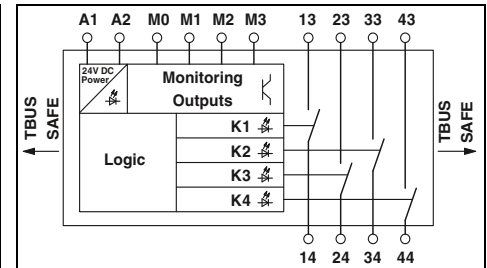

Technical data

Module data	
Nominal input voltage U_N	24 V DC (via PSR-TBUS)
Permissible range (with reference to U_N)	0.85 ... 1.1
Typ. current consumption (with reference to U_N)	120 mA
Max. response time	-
Input data	
Number of safe inputs	-
Nominal voltage	-
Output data	
Safe semiconductor outputs	-
Nominal voltage	-
Limiting continuous current	-
Contact type	-
Contact material	-
Max./min. switching voltage	-
Limiting continuous current	-
Max./min. inrush current	-
Min. switching power	-
Short-circuit protection of the output circuits	-
Response time	-
Cycle/alarm outputs	-
Alarm outputs	4
General data	
Ambient temperature range	-20 °C ... 55 °C
Screw connection solid / stranded / AWG	0.2 - 2.5 mm ² / 0.2 - 2.5 mm ² / 24 - 12
Spring-cage connection solid / stranded / AWG	0.2 - 1.5 mm ² / 0.2 - 1.5 mm ² / 24 - 16
Dimensions	22.5 mm / 99 mm / 114.5 mm
W / H / D	22.5 mm / 112 mm / 114.5 mm
EMC note	Class A product, see page 527

Ordering data

Description	Type	Order No.	Pcs. / Pkt.
Extension module , 4 safe relay outputs (1-channel) or 2 relay outputs (2-channel)			
With screw connection	PSR-SCP- 24DC/TS/SDOR4/4X1	2986096	1
With spring-cage connection	PSR-SPP- 24DC/TS/SDOR4/4X1	2986106	1

Accessories

PSR-TBUS DIN rail connector, for supplying/controlling/monitoring (depending on the module)	PSR-TBUS	2890425	50
---	----------	---------	----

PLC series
Terminal block with integrated test pulse and EMC filter

The **PSR-FTB** filter terminal block is used in the event of problems with 24 V signals affected by EMI and test-pulse-sensitive loads.

- Filtering of test-pulse-safe electronic outputs
- EMC filter for constant 24 V signals
- Easy wiring using push-in connection technology



For low loads up to a maximum of 65 mA



For high loads up to a maximum of 530 mA

Notes:

The selection of the filter terminal block depends on several parameters (load resistance/current, voltage drop, accepted shutdown time). The parameters can be determined with the aid of more detailed documentation, see phoenixcontact.net/products.

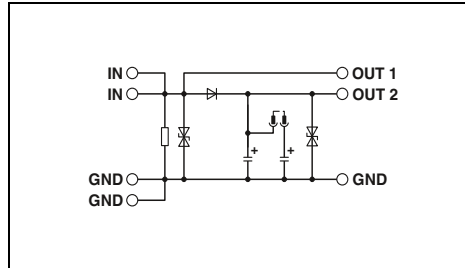

Technical data

Input data	
Nominal input voltage U_N	
Typ. input current at U_N	
Protective circuit	
General data	
Ambient temperature range	
Air and creepage distances between the circuits	
Rated surge voltage/insulation	
Push-in connection solid / stranded / AWG	
Dimensions	W / H / D
EMC note	

24 V DC $\pm 20\%$ (control voltage U_{ST} right/left)
Max. 15 mA
Surge protection
-25 °C ... 55 °C
EN 61131
1.5 kV / basic insulation
0.14 - 2.5 mm ² / 0.14 - 2.5 mm ² / 26 - 14
6.2 mm / 94 mm / 80 mm
Class A product, see page 527

Ordering data

Description
PLC filter terminal block , with integrated test pulse and EMC filter

Type	Order No.	Pcs. / Pkt.
PSR-FTB/1.5/11.5	2904476	1

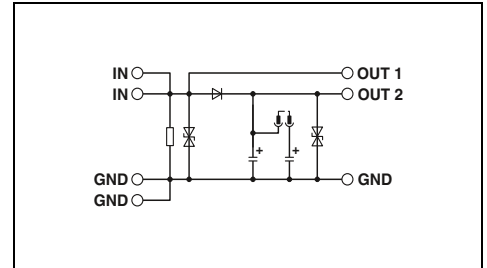

Technical data

24 V DC $\pm 20\%$ (control voltage U_{ST} right/left)
Max. 20 mA
Surge protection
-25 °C ... 55 °C
EN 61131
1.5 kV / basic insulation
0.14 - 2.5 mm ² / 0.14 - 2.5 mm ² / 26 - 14
6.2 mm / 94 mm / 80 mm
Class A product, see page 527

Ordering data

Type	Order No.	Pcs. / Pkt.
PSR-FTB/20/86	2904477	1

Logic modules

The IB IL 24 LPSDO 8 V3-PAC logic module extends the possible field of application of the system significantly. In addition to the 16 possible connections for remote safe I/O modules, it also supports direct communication between the logic modules.

Features:

- Generation and monitoring of the SafetyBridge protocol
- Processing of the parameterized safety logic
- Control of 8 safe outputs onboard

Notes:

Further information on the SAFECONF configuration software can be found on page 88



Connection of up to 5 safe input/output modules



Connection of up to 16 safe input/output modules



	Technical data	Technical data
Local bus interface		
Connection technology	Inline data jumper	Inline data jumper
Transmission speed	500 kbps / 2 Mbps (can be switched)	500 kbps / 2 Mbps (can be switched)
Power supply for module electronics		
Supply voltage	24 V DC (via voltage jumper)	24 V DC (via voltage jumper)
Supply voltage range	19.2 V DC ... 30 V DC	19.2 V DC ... 30 V DC
Digital outputs		
Connection method	2, 3, 4-wire	2, 3, 4-wire
Maximum number of outputs	8	8
Maximum output current per channel	2 A	2 A
Protective circuit	Overload protection, short-circuit protection of outputs	Overload protection, short-circuit protection of outputs
SafetyBridge properties		
Connection to I/O modules	Max. 5 (safe digital I/O modules)	Max. 16 (safe digital I/O modules)
Logic memory	24 kbyte	60 kbyte
General data		
Connection method	Spring-cage connection	Spring-cage connection
Connection data solid / stranded / AWG	0.2 ... 1.5 mm ² / 0.2 ... 1.5 mm ² / 24 - 16	0.2 ... 1.5 mm ² / 0.2 ... 1.5 mm ² / 24 - 16
Dimensions	48.8 mm / 119.8 mm / 71.5 mm	48.8 mm / 119.8 mm / 71.5 mm
Ambient temperature (operation)	-25 °C ... 55 °C	-25 °C ... 55 °C
EMC note	Class A product, see page 527	Class A product, see page 527

	Ordering data			Ordering data		
Description	Type	Order No.	Pcs. / Pkt.	Type	Order No.	Pcs. / Pkt.
Safety-related digital logic module						
- Connection to a maximum of five safe I/O modules	IB IL 24 LPSDO 8 V2-PAC	2700606	1			
- Connection to a maximum of 16 safe I/O modules				IB IL 24 LPSDO 8 V3-PAC	2701625	1

	Accessories			Accessories		
Plug set, consisting of four Inline plugs with integrated discharge electronics	IB IL 24 PSDO 8-PLSET/CP/R	2700722	1	IB IL 24 PSDO 8-PLSET/CP/R	2700722	1
Configuration software for SafetyBridge and PSR-TRISAFE modules, can be downloaded free of charge at phoenixcontact.net/products	SAFECONF	2986119	1	SAFECONF	2986119	1
Starter kit, including ILC 130 ETH, LPSDO, and PSDI SafetyBridge modules, control panel, power supply unit, plus accessories with preconfigured safety application	ILC 130 SBT V2 STARTERKIT	2700993	1			

Zack marker strip, flat (see Catalog 5)	ZBF 6...	ZBF 6...
---	----------	----------

Safe I/O modules

The safe input modules can be used universally. The modules can be used in INTERBUS-Safety systems, PROFIsafe systems via PROFIBUS or PROFINET, and SafetyBridge systems.

Within the relevant safety system, safety functions can be implemented according to the following requirements:

- Up to Cat. 4/PL e according to EN ISO 13849-1, SILCL 3 according to IEC 62061, SIL 3 according to IEC 61508

Notes:
Further information on the SAFECONF configuration software can be found on page 88



Digital input module,
16 inputs



Digital input module,
8 inputs



Local bus interface	
Connection technology	
Transmission speed	
Power supply for module electronics	
Supply voltage	
Supply voltage range	
Digital inputs	
Connection technology	
Number of inputs	
General data	
Dimensions	W / H / D
Ambient temperature (operation)	
EMC note	

Technical data	
Inline data jumper	
500 kbps / 2 Mbps (can be switched)	
24 V DC (via voltage jumper)	
19.2 V DC ... 30 V DC	
2, 3-wire	
8 (with two-channel assignment)	
48.8 mm / 141 mm / 71.5 mm	
-25 °C ... 55 °C	
Class A product, see page 527	

Technical data	
Inline data jumper	
500 kbps / 2 Mbps (can be switched)	
24 V DC (via voltage jumper)	
19.2 V DC ... 30 V DC	
2, 3, 4-wire	
4 (with two-channel assignment)	
48.8 mm / 119.8 mm / 71.5 mm	
-25 °C ... 55 °C	
Class A product, see page 527	

Ordering data	
Description	
Failsafe digital input module	
- 16 inputs	
- 8 inputs	

Ordering data		
Type	Order No.	Pcs. / Pkt.
IB IL 24 PSDI 16-PAC	2700994	1

Ordering data		
Type	Order No.	Pcs. / Pkt.
IB IL 24 PSDI 8-PAC	2985688	1

Accessories	
Plug set, consisting of four Inline plugs with integrated discharge electronics	
Zack marker strip, flat (see Catalog 5)	

Accessories	
ZBF 6...	

Accessories		
Type	Order No.	Pcs. / Pkt.
IB IL 24 PSDI 8-PLSET/CP/R	2700720	1
ZBF 6...		

Safe I/O modules

The safe I/O modules can be used universally. The modules can be used in INTERBUS-Safety systems, PROFIsafe systems via PROFIBUS or PROFINET, and SafetyBridge systems.

The product range comprises safe input modules, positive wired output modules, positive/negative wired output modules, and floating output modules with integrated relay contacts.

An Inline station can be made up of safe and standard modules here, whereby a variety of function terminals are available to the user. The station is configured with high granularity with digital and analog inputs or outputs.

Within the relevant safety system, safety functions can be implemented according to the following requirements:

- Up to Cat. 4/PL e according to EN ISO 13849-1, SILCL 3 according to IEC 62061, SIL 3 according to IEC 61508

Notes:

Further information on the SAFECONF configuration software can be found on page 88



Digital output module



Local bus interface	
Connection technology	Inline data jumper
Transmission speed	500 kbps/ / 2 Mbps (can be switched)
Power supply for module electronics	
Supply voltage	24 V DC (via voltage jumper)
Supply voltage range	19.2 V DC ... 30 V DC
Digital outputs	
Connection technology	2, 3, 4-wire
Number of outputs	4 (with two-channel assignment)
Maximum output current per channel	2 A
Protective circuit	Overload protection, short-circuit protection of outputs
General data	
Dimensions	W / H / D 48.8 mm / 119.8 mm / 71.5 mm
Ambient temperature (operation)	-25 °C ... 55 °C
EMC note	Class A product, see page 527

Technical data		
Local bus interface		
Connection technology		
Transmission speed		
Power supply for module electronics		
Supply voltage		
Supply voltage range		
Digital outputs		
Connection technology		
Number of outputs		
Maximum output current per channel		
Protective circuit		
General data		
Dimensions		
Ambient temperature (operation)		
EMC note		

Description
Failsafe digital output module
- 8 outputs
Failsafe relay output module
- 4 outputs
Safety digital output module, +/- switching
- 4 outputs
Plug set, consisting of four Inline plugs with integrated discharge electronics
Zack marker strip, flat (see Catalog 5)

Ordering data		
Type	Order No.	Pcs. / Pkt.
IB IL 24 PSDO 8-PAC	2985631	1
Accessories		
IB IL 24 PSDO 8-PLSET/CP/R	2700722	1
ZBF 6...		



Relay output module



Digital output module, +/- wired



Technical data
Inline data jumper 500 kbps / 2 Mbps (can be switched)
24 V DC (via voltage jumper) 19.2 V DC ... 30 V DC
2-wire 4 (safety relays) 4 A -
73.2 mm / 119.8 mm / 71.5 mm -25 °C ... 55 °C Class A product, see page 527

Technical data
Inline data jumper 500 kbps / 2 Mbps (can be switched)
24 V DC (via voltage jumper) 19.2 V DC ... 30 V DC
2, 3, 4-wire 4 (for two-channel assignment, +/- switching) 2 A Overload protection, short-circuit protection of outputs
48.8 mm / 119.8 mm / 71.5 mm -25 °C ... 55 °C Class A product, see page 527

Ordering data		
Type	Order No.	Pcs. / Pkt.
IB IL 24 PSDOR 4-PAC	2985864	1

Ordering data		
Type	Order No.	Pcs. / Pkt.
IB IL 24 PSDO 4/4-PAC	2916493	1

Accessories		
Type	Order No.	Pcs. / Pkt.
ZBF 6...		

Accessories		
Type	Order No.	Pcs. / Pkt.
IB IL 24 PSDO 4/4-PLSET/CP/R	2700721	1
ZBF 6...		

Safe I/O modules

You can install the safety-related Axioline F PROFIsafe I/O modules anywhere inside an Axioline station. In addition to standard signals, this means you can now also read and output safe signals in the Axioline system.

Depending on the installation and parameterization, you can achieve the following safety characteristics with these modules:

- Up to Cat. 4/PL e according to EN ISO 13849-1, SILCL 3 according to IEC 62061, SIL 3 according to IEC 61508

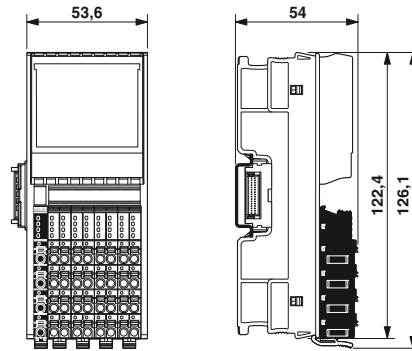

Digital input module

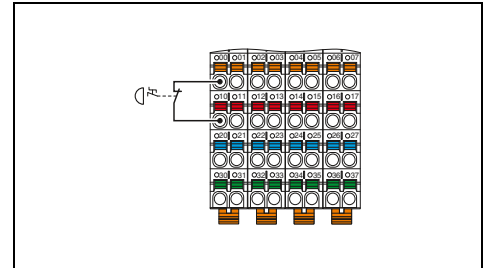

Local bus interface			
Designation	Axioline F local bus		
Connection technology	Bus base module		
Power supply for module electronics			
Communications power U_{Bus}	5 V DC (via bus base module)		
Current consumption from U_{Bus}	typ. 280 mA (all inputs set; power supply by U_1 of 19.2 V DC to 30.2 V DC)		
I/O supply			
Supply of digital input modules U_1	24 V DC		
Supply voltage range U_1	19.2 V DC ... 30.2 V DC (including all tolerances, including ripple)		
Current consumption from U_1	typ. 9 mA (all inputs set; power supply by U_1 with 30.2 V DC; without power supply to the sensors via clock supplies T1 and T2)		
Protective circuit			
Protection against polarity reversal, EMC protective circuit, undervoltage detection			
Digital inputs			
Connection technology	2, 3, 4-wire		
Number of inputs	4 (with two-channel assignment) 8 (with single-channel assignment)		
Description of the inputs	IEC 61131-2 type 3		
Nominal input voltage U_{IN}	24 V DC		
Nominal input current at U_{IN}	typ. 4.2 mA		
Input filter time	1.5 ms 3 ms (default) 5 ms 15 ms		
General data			
Connection method	Direct plug-in technology		
Connection data solid / stranded / AWG	0.2 ... 1.5 mm ² / 0.2 ... 1.5 mm ² / 24 - 16		
Weight	220 g		
Dimensions	53.6 mm / 126.1 mm / 54 mm		
Ambient temperature (operation)	-35 °C ... 60 °C (mounting position: any)		
Ordering data			
Description	Type	Order No.	Pcs. / Pkt.
Failsafe digital input module	AXL F PSDI8/4 1F	2701559	1
- 4 inputs (two-channel), 8 inputs (single-channel)			

Safe I/O modules

You can install the safety-related Axioline F PROFIsafe I/O modules anywhere inside an Axioline station. In addition to standard signals, this means you can now also read and output safe signals in the Axioline system.

Depending on the installation and parameterization, you can achieve the following safety characteristics with these modules:

- Up to Cat. 4/PL e according to EN ISO 13849-1, SILCL 3 according to IEC 62061, SIL 3 according to IEC 61508

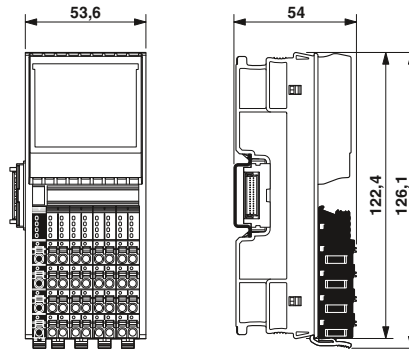

Digital output module

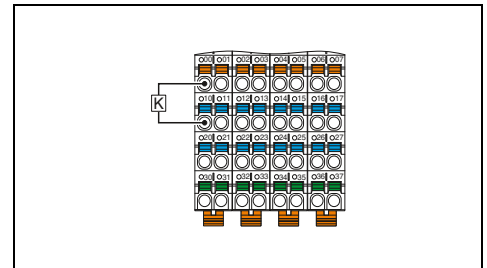

Technical data

Local bus interface	Axioline F local bus
Designation	Bus base module
Connection technology	
Power supply for module electronics	
Communications power U_{Bus}	5 V DC (via bus base module)
Current consumption from U_{Bus}	typ. 260 mA (all outputs set; power supply by U_O of 19.2 V DC to 30.2 V DC)
I/O supply	
Supply of digital output modules U_O	24 V DC
Supply voltage range U_O	19.2 V DC ... 30.2 V DC (including all tolerances, including ripple)
Current consumption from U_O	typ. 25 mA (all outputs set; power supply by U_O with 30.2 V DC; without power supply to the actuator)
Protective circuit	Protection against polarity reversal, EMC protective circuit, undervoltage detection
Digital outputs	
Connection technology	2, 3-wire
Number of outputs	4 (with two-channel assignment) 8 (with single-channel assignment)
Output voltage	24 V DC
Output current	Max. 2 A (per channel)
Maximum output current per module / terminal block	8 A
Behavior in the event of overload	Affected output is disabled and a diagnostic message is generated.
Protective circuit	Overload protection, freewheeling circuit for inductive loads, discharge circuit for accelerated discharge of capacitive loads
General data	
Connection method	Direct plug-in technology
Connection data solid / stranded / AWG	0.2 ... 1.5 mm ² / 0.2 ... 1.5 mm ² / 24 - 16
Weight	220 g
Dimensions	53.6 mm / 126.1 mm / 54 mm
Ambient temperature (operation)	-35 °C ... 60 °C (mounting position: any)

Ordering data

Description	Type	Order No.	Pcs. / Pkt.
Failsafe digital output module			
- 4 outputs (two-channel), 8 outputs (single-channel)	AXL F PSDO8/3 1F	2701560	1

SAFECONF – configuration software

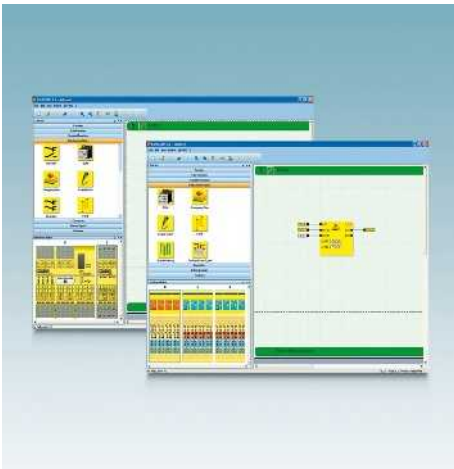

The software implements the consistent configuration of the safety function and the parameterization of the safe SafetyBridge and PSR-TRISAFE modules.

Instead of being programmed, the required functions and components are simply dragged to the connection editor, where they can be linked. It takes just three steps to create a project, test it, and transfer it to the safety module.

When using SafetyBridge modules, you can create the safe configuration independently of the controller and automation network used.



Configuration software for PSR-TRISAFE and SafetyBridge modules

Hardware requirements	
Processor	Pentium, 2 GHz (recommended), 1 GHz (min.)
Main memory (RAM)	2 Gbyte (with Windows 7 / Windows 8: 1 Gbyte (min.) with Windows XP 512 Mbytes (min.))
Hard disk memory	min. 250 Mbyte (free hard disk memory space)
Optical drive	CD-ROM
Operating equipment	Keyboard, mouse
Monitor resolution	800x600
Software requirements	
Operating systems	MS Windows® 7 Professional (32-bit/64-bit), SP1 / MS Windows® 8 (32-bit/64-bit) / MS Windows XP (SP3) Multi-Language
Supported browsers	Internet Explorer 6 or higher
Basic functions	
Languages supported	
German, English, French, Spanish, Italian	

Technical data		
Configuration software for PSR-TRISAFE and SafetyBridge technology		
German, English, French, Spanish, Italian		

Description	Configuration software for SafetyBridge and PSR-TRISAFE modules , can be downloaded free of charge at phoenixcontact.net/products	
-------------	---	--

Ordering data		
Type	Order No.	Pcs. / Pkt.
SAFECONF	2986119	1

**PSR-CONF-WIN –
configuration software**

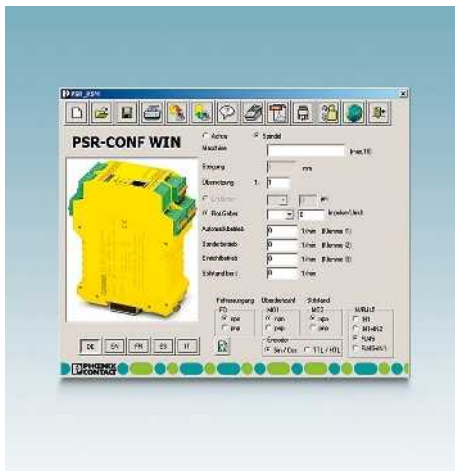

The PSR-CONF-WIN configuration package is used to parameterize the PSR-RSM4 safe downtime and speed monitor.
Application-related safety parameters such as downtime and speed limits can be set in the software. The data is then transferred to the safety switching device.



Configuration software and connecting cable

Hardware requirements
Processor
Main memory (RAM)
Hard disk memory
Optical drive
Operating equipment
Monitor resolution
Software requirements
Operating systems
Basic functions
Expanded functionality
Languages supported

Description
Configuration software for parameterizing the PSR-RSM4 safe downtime and speed monitor, with programming cable

ERIC	
Technical data	
Processor	Pentium, 2 GHz (recommended), 1 GHz (min.)
Main memory (RAM)	1 Gbyte (with Windows 7/with Windows XP: 512 Mbytes (min.))
Hard disk memory	min. 250 Mbyte (free hard disk memory space)
Optical drive	CD-ROM
Operating equipment	Keyboard, mouse
Monitor resolution	800x600
Software requirements	MS Windows® 7 (32-bit/64-bit) / MS Windows XP / MS Windows NT 4.0 with Service Pack > 4, MS Windows 2000 and MS Windows XP
Basic functions	Configuration software for PSR-RSM4 safe downtime and speed monitor
Expanded functionality	Languages supported
	German, English, French, Spanish, Italian

Ordering data		
Type	Order No.	Pcs. / Pkt.
PSR-CONF-WIN1.0	2981554	1

SAFETYPROG – programming software

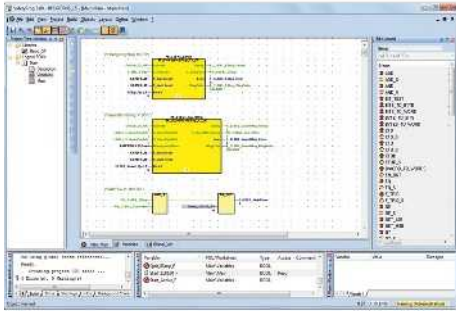

Notes:

Further information on the safe PROFIsafe controller can be found on page 93



Programming software for INTERBUS-Safety systems and PROFIsafe controllers

SAFETYPROG can be used to develop safe applications with safety controllers - using PROFIsafe or INTERBUS-Safety networks.

The TÜV-certified programming tool guides you through the various development phases of a safety application:

- IEC 61131-compliant programming in function block diagram (FBD), ladder diagram (LD), and structured text (ST)
- Compiling the project
- Sending the project to the safety controller
- Controlling the safety controller, e.g., start, stop or reset
- Performing function tests
- Monitoring the safety controller and debugging the safety application
- Project documentation
- Printing project documentation

SAFETYPROG contains a comprehensive library with 20 certified function blocks for safety technology, all according to PLCopen safety specification 1.0.

Useful tools

SAFETYPROG offers many innovative tools, which enable you to integrate Functional Safety in your automation system:

- User management
- Bus configuration project for importing process and diagnostic data
- Bus navigator
- Code editor and Edit wizard
- Coupling of safe and standard PLC
- Project tree
- Cross-reference and message windows
- Controller simulation
- Variable editor

Description

Programming software for INTERBUS-Safety systems and PROFIsafe controllers, with graphical user interface according to IEC 61131-3 in function block diagram (FBD) and ladder diagram (LD).

One library from the corresponding **PLCopen libraries** can be used per project.

Programming software for INTERBUS-Safety systems and PROFIsafe controllers, with graphical user interface according to IEC 61131-3 in function block diagram (FBD) and ladder diagram (LD).

Three of the libraries from the corresponding **PLCopen libraries** can be used per project.

Programming software for INTERBUS-Safety systems and PROFIsafe controllers, with graphical user interface according to IEC 61131-3 in function block diagram (FBD) and ladder diagram (LD).

All of the libraries from the corresponding **PLCopen libraries** can be used per project.

Ordering data

Type	Order No.	Pcs. / Pkt.
SAFETYPROG BASIC	2700443	1
SAFETYPROG ADVANCED	2700441	1
SAFETYPROG PROFESSIONAL	2700442	1

Safe analog value processing

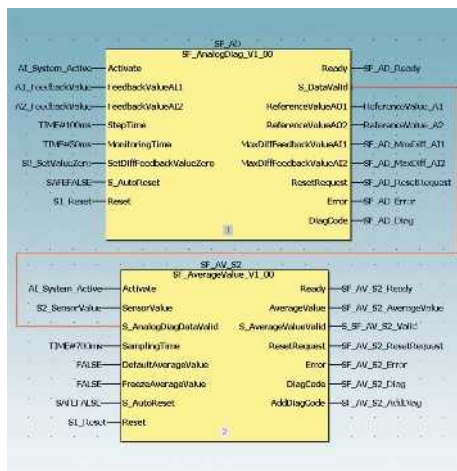

Function block library for safety-related analog value acquisition with standard I/O modules.

Please contact the safety hotline before ordering **SAFE AI**.

24-hour safety hotline

+49 5281 9-462777

safety-service@phoenixcontact.com

Wherever analog values need to be processed in a safety-related manner, the Safe AI solution package from Phoenix Contact is the ideal solution. With this TÜV-certified and software-based analog value processing, no safety-related I/O modules are required. This saves you money and offers flexibility.

Components of the Safe AI solution package:

- Initial application advice via telephone on the required software and hardware components
- License key for using the ANALOGINPUT_SF function block library including user documentation
- Advice from the Competence Center Safety in the form of a web meeting

Description

Function block library for safety-related analog value acquisition with standard I/O modules

Ordering data

Type	Order No.	Pcs. / Pkt.
SAFE AI	2400057	1

Functional Safety

Safe control technology

Safe PROFINET gateway

The safe PROFINET gateway from Phoenix Contact enables secure communication between two PROFINET networks. This means that you can implement system-wide and manufacturer-independent Functional Safety, such as emergency stop concepts.

Your advantages:

- Coupling of two PROFINET systems
- Transmission of standard I/O data via PROFINET
- Transmission of safe I/O data via PROFIsafe
- Redundant power supply
- Control-independent

Within a PROFIsafe system, the safety functions associated with the following requirements are supported:

- SIL 3 according to IEC 61508
- SILCL 3 according to IEC 61508
- PL e according to EN ISO 13849-1



Safe PROFINET gateway

PROFIBUS PROFIsafe

Supply	
Supply voltage	24 V DC
Supply voltage range	18.5 V DC ... 30 V DC (including ripple)
Current consumption	Max. 250 mA
Programming data	
IN and OUT process data	128 bytes (2 - 11 bytes of safe I/O process data)
General data	
Weight	550 g
Dimensions	130 mm / 27 mm / 145 mm W / H / D
Ambient temperature (operation)	-25 °C ... 60 °C
EMC note	Class A product, see page 527

Technical data

Supply	
Supply voltage	24 V DC
Supply voltage range	18.5 V DC ... 30 V DC (including ripple)
Current consumption	Max. 250 mA
Programming data	
IN and OUT process data	128 bytes (2 - 11 bytes of safe I/O process data)
General data	
Weight	550 g
Dimensions	130 mm / 27 mm / 145 mm W / H / D
Ambient temperature (operation)	-25 °C ... 60 °C
EMC note	Class A product, see page 527

Description
Safe PROFINET gateway

Ordering data

Type	Order No.	Pcs. / Pkt.
FL PN/PN SDIO-2TX/2TX	2700651	1

Color marking for FL CAT... Patch...	
- Blue	
- Red	
Lockable security element for FL PATCH...	
Key for FL PATCH GUARD	
Security element for FL CAT ...patch...	

Accessories

	Order No.	Pcs. / Pkt.
FL PATCH CCODE BU	2891291	20
FL PATCH CCODE RD	2891893	20
FL PATCH GUARD	2891424	20
FL PATCH GUARD KEY	2891521	1
FL PATCH SAFE CLIP	2891246	20

Safe PROFIsafe controller

The RFC 470S is the safety version of the most powerful high-end PLC and offers all the features of the class 400 high-performance controller. In addition, it has an integrated safety controller. This combination can be used to integrate safety functions up to SIL 3 into existing systems.

Your advantages:

- The use of PROFIsafe reduces wiring effort and installation time
- Thanks to the integrated PROFINET interface, the RFC 470S communicates directly with PROFIsafe modules
- The safety function is programmed using the SAFETYPROG software

Depending on the parameterization of the I/O modules and the programming, the RFC 470S can meet the following requirements:

- SIL 3 according to IEC 61508
- SILCL 3 according to IEC 61508
- PL e according to EN ISO 13849-1

Notes:
Further information on class 400 high-performance controllers can be found in the "Controllers" section of this catalog.
Further information on the SAFETYPROG programming software can be found on page 90



Class 400 compact controller with integrated safety controller

Functional Safety

Technical data	
Interfaces	D-SUB-9 socket 3x RJ45 sockets RS-232-C, D-SUB connector, 10/100 Ethernet (RJ45), 2x USB
INTERBUS master	Max. 126 Max. 512 (of which 254 are remote bus devices/bus segments)
Amount of process data	Max. 8192 bits (INTERBUS)
Direct I/Os	14-pos. FLK pin strip 5 3
IEC-61131 runtime system	0.005 ms (1 K mix instructions) 1 µs (1 K bit instructions) typ. 8 Mbyte (680 K instructions (IL)) 16 Mbyte 240 kbyte (NVRAM) depends on mass storage depends on mass storage 16 Integrated (battery backup)
Processing speed	
Program memory	
Mass storage	
Retentive mass storage	
Number of data blocks	
Number of timers, counters	
Number of control tasks	
Realtime clock	
Power supply	
Power supply connection	Screw terminal blocks, plug-in
Supply voltage	24 V DC
Supply voltage range	19.2 V DC ... 30 V DC (including ripple)
Typical current consumption	1 A
General data	
Dimensions	124 mm / 185 mm / 190 mm
Degree of protection	IP20
Ambient temperature (operation)	0 °C ... 55 °C (from 45°C only with fan module)
EMC note	Class A product, see page 527

Description
Safety controller

Parameterization memory - 256 MB - 2 GB
Programming cable , to connect the controller boards to the PC (RS-232-C), length 3 m
RS-232 null modem adapter - 9-pos. socket to 9-pos. connector
Fan module for Remote Field Controller
AX OPC SERVER , communication interface for OPC-compatible visualization with PC Worx-based controllers
SAFETYPROG programming software - Basic - Advanced - Professional
Engineering software

Ordering data		
Type	Order No.	Pcs. / Pkt.
RFC 470S PN 3TX	2916794	1

Accessories		
Type	Order No.	Pcs. / Pkt.
CF FLASH 256MB	2988780	1
CF FLASH 2GB	2701185	1
IBS PRG CAB	2806862	1
PSM-AD-D9-NULMODEM	2708753	1
RFC DUAL-FAN	2730239	1
AX OPC SERVER	2985945	1
SAFETYPROG BASIC	2700443	1
SAFETYPROG ADVANCED	2700441	1
SAFETYPROG PROFESSIONAL	2700442	1
PC Worx ... (see "Software" section)		

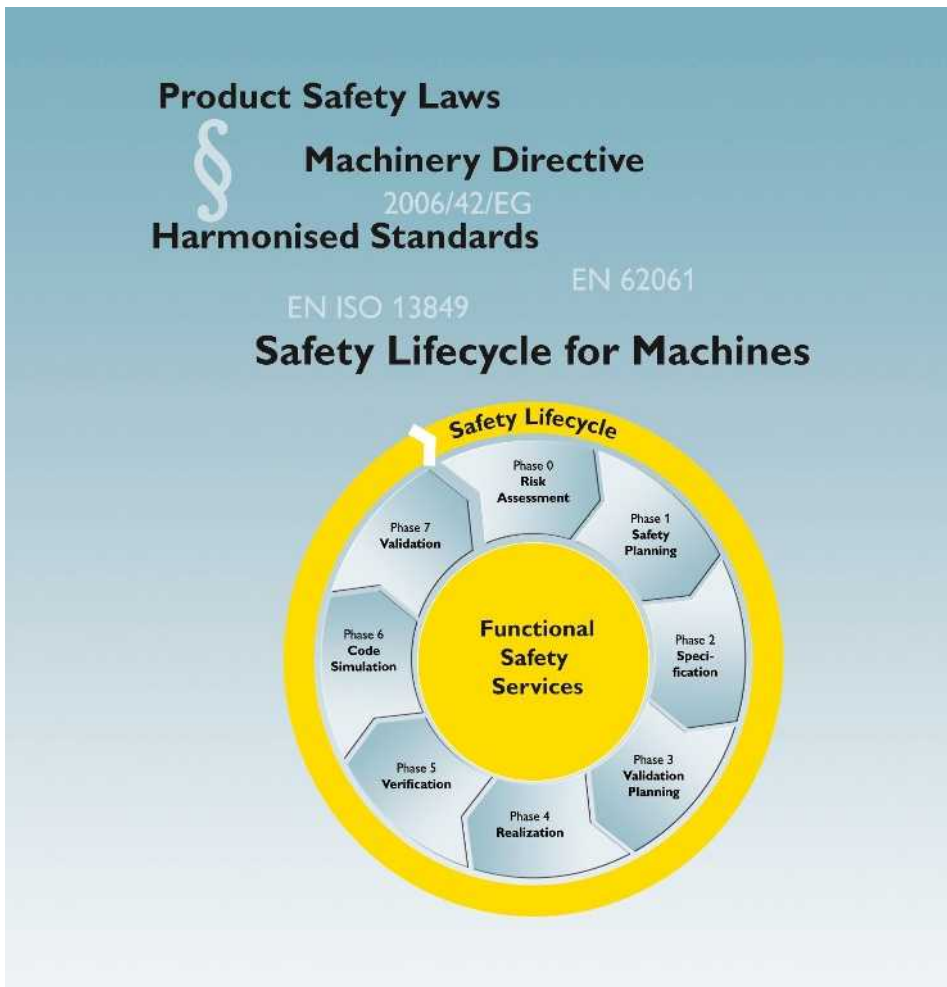

Safety lifecycle

Based on the harmonized standards of the Machinery Directive, Phoenix Contact has developed a phase model, which represents the safety lifecycle. This structured procedure assists in the application of and conformance with the harmonized standards of the Machinery Directive.

The safety lifecycle represents a specific process for the design and manufacture of machinery, which fully includes the requirements for Functional Safety. The phase-specific verification documentation already includes the contents required in order to demonstrate CE conformance. This is a legal requirement for placing items on the market in the European Economic Area.

Expert support

With our services for Functional Safety, we focus on the safety lifecycle for machines. This means that as the person responsible, you can be sure that all systematic errors will be eliminated on your machine and all requirements of standards will be met.

We are on hand to assist you throughout the entire lifecycle of your application: we provide support from the initial risk assessment, drafting the concept, implementation, startup, and operation right up to system modernization.

- The choice is yours:
- Appoint one of our safety experts for consultation, process assistance, engineering or service activities
 - Ask us to train and qualify your employees

Your advantages from our safety services

- Time saved by transferring safety requirements
- Maximum legal certainty
- Optimum technical safety solution
- Sophisticated process management
- Target-oriented project management
- Traceable, legal protection thanks to consistent documentation

First aid

If queries arise during startup and operation, in addition to your local specialists you can also contact our free 24-hour safety hotline at any time: **(+ 49 5281 9-462777)**

Alternatively send an e-mail to: safety-service@phoenixcontact.com



Safety consulting
Order No. 2700501

Through individual consultations we are here to advise you from the initial planning of your safety-related application right up to startup.

Web consulting
Order No. 9064679

No matter where you are, we can also provide advice about the machine safety process.



Safety presentation
Order No. 2701589

Our experts provide support for your safety designers directly on site at your company in a moderation capacity. They explain how to use the documentation templates that we provide you for verification documentation. We discuss with you the technical contents for your specific application.



Safety engineering
Order No. 2700505

Based on your released development documents, we implement Functional Safety for you:

- Safety concept
- Safety planning
- Integration planning
- Machine planning
- SIL/PL verification
- Test implementation



Product support

Our safety specialists will answer any questions you have about our safety hardware and software products via our free 24-hour safety hotline.

Furthermore, we can hold product workshops with you, support you on site during startup and servicing, and help you plan your own individual safety concept.



Seminars and workshops

Phoenix Contact offers a wide range of content for seminars as well as different types of seminars on Functional Safety. Depending on your existing level of knowledge, you can start with the basics, refresh your knowledge or indeed become an expert thanks to our seminars.

If you require specialist knowledge and wish to arrange the training location and schedule yourself, we can create an individual training course for you.

Services for Industrial Ethernet can be found on page 324.

Services for automation can be found on page 488.



HMI and industrial PCs

HMI and industrial PCs are the key to the efficient operation and monitoring of your systems and machines. You can work with a fully enclosed IP65 panel PC directly on site – or design detailed user interfaces as the interface to your system using a powerful HMI device.

Industrial PCs and HMIs from Phoenix Contact are so versatile and flexible that they do not present any restrictions for your operation and monitoring concepts. Visu+ and WebVisit are the corresponding visualization software tools.

HMI

Human-machine interfaces, or HMIs for short, represent cost-effective automation based on efficient input and monitoring. Depending on your requirements, you can select devices for WebVisit or Visu+ software, or for HTML5 applications. Whether directly on site, centrally in the control center, high performance or multifunctional: it is you who determines the features of the HMIs.

Industrial PCs

Industrial PCs, or IPCs for short, combine the computing capacity of modern processors with the robustness and reliability of industrial components. Together with the right software, IPCs are efficient and versatile solutions for controlling, operating, and monitoring systems and machines.

Product overview	98
<hr/>	
HMI	
HMI for HTML5 applications	100
HMI for WebVisit software	102
HMI for Visu+ software	104
HMI for maritime applications	110
<hr/>	
Industrial PCs	
Box PCs	112
Monitors with touch function	120
Panel PCs	122
Rackmount PC	136

HMIs and industrial PCs

Product overview

HMIs for HTML5 applications



Web panels with open browser Page 100



Minitouch Page 102



Web panel Page 102

Box PCs



Box PC for wall or DIN rail mounting Page 112



Valueline box PC Page 114



Valueline box PC Page 116



Basicline box PC Page 118

Panel PCs



Embeddedline panel PCs Page 122



Basicline panel PCs Page 124



Valueline panel PCs Page 126



Valueline panel PCs Page 128

Software



WebVisit – development software for web-based visualizations Page 441



Visu+ – SCADA visualization, development and runtime licenses Page 442

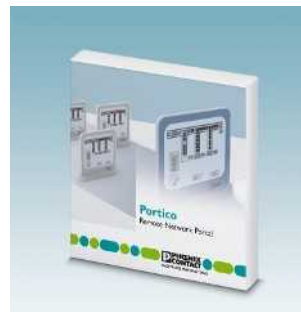

VL Portico server ... – remote control of networked IPCs Page 455

HMI for Visu+ software



Touch panels

Page 105



Touch panels

Page 106



Touch panels

Page 109

HMI for maritime applications



Touch panels

Page 110

Monitors with touch function



Monitors with touch function

Page 120

Rackmount PCs



Rackmount PC – 4U

Page 136



Rackmount PC – 2U

Page 136



Panel PCs in IP65

Page 130



Panel PCs for outdoor applications

Page 132



Panel PCs for maritime applications

Page 134

Software PLC



PC Worx RT BASIC – software PLC with realtime extension

Page 484

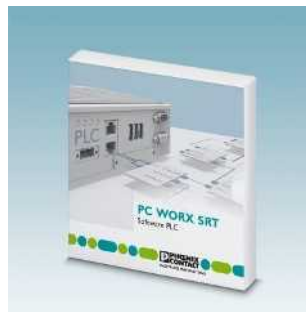

PC Worx SRT – software PLC without realtime extension

Page 484

Web panels with open browser

These touch panels are operator panels with a WebKit-based browser as the user software. This means that all web-based visualizations that support the current HTML5 web standard can be displayed.

Your advantages:

- Used exclusively for operation, the browser is the only interactive interface
- Flexible, thanks to open web standard and free choice of web server and visualization software
- Independent visualization with self-programmed JavaScript applications
- Secure communication, thanks to SSL-encrypted data transmission
- No security updates for JAVA or Flash plug-ins, thanks to HTML5

new

new



14.5 cm (5.7") TFT color display



17.8 cm (7") TFT color display

Technical data	
Display data	
Display	14.5 cm/5.7" TFT active
Monitor resolution	640 x 480 Pixel (VGA)
Display lighting type	LED
Brightness	400 cd/m ² , typical (adjustable)
Display backlight MTBF	40,000 h
Color spectrum	262,144 colors
Touch screen	Resistive industrial touch screen
Computer data	
Operating systems	Debian GNU/Linux
Processor	ARM® Cortex®-A8, 800 MHz
RAM	512 MB RAM
Mass storage	1 GB Flash
Interfaces	2x USB Host 2.0
Network	1 x Ethernet (10/100 Mbps), RJ45
External dimensions	
Dimensions	W / H / D 168 mm / 126 mm / 5 mm
Installation dimensions	
Dimensions	W / H / D 160 mm / 118 mm / -
General data	
Degree of protection	IP65 (front), IP20 (back)
Ambient temperature (operation)	0 °C ... 50 °C
Mounting type	Installation in front plate
Vibration (operation)	DIN EN 60068-2-6
Shock	DIN EN 60068-2-27

Technical data	
Display data	
Display	17.8 cm/7" TFT
Monitor resolution	800 x 480 Pixel (WVGA)
Display lighting type	LED
Brightness	350 cd/m ² , typical (adjustable)
Display backlight MTBF	40,000 h
Color spectrum	262,144 colors
Touch screen	Resistive industrial touch screen
Computer data	
Operating systems	Debian GNU/Linux
Processor	ARM® Cortex®-A8, 800 MHz
RAM	512 MB RAM
Mass storage	1 GB Flash
Interfaces	2x USB Host 2.0
Network	1 x Ethernet (10/100 Mbps), RJ45
External dimensions	
Dimensions	W / H / D 203 mm / 147 mm / 5 mm
Installation dimensions	
Dimensions	W / H / D 195 mm / 139 mm / -
General data	
Degree of protection	IP65 (front), IP20 (back)
Ambient temperature (operation)	0 °C ... 50 °C
Mounting type	Installation in front plate
Vibration (operation)	DIN EN 60068-2-6
Shock	DIN EN 60068-2-27

Ordering data		
Type	Order No.	Pcs. / Pkt.
WP 3057V	2400251	1

Ordering data		
Type	Order No.	Pcs. / Pkt.
WP 3070W	2400253	1

Accessories		
HMI SCB MOUNTING KIT 6	2701385	1

Accessories		
HMI SCB MOUNTING KIT 6	2701385	1

Mounting kit , including hardware for installation		
- panel installation		

new



26.4 cm (10.4") TFT color display

new



30.7 cm (12.1") TFT color display

new



39.05 cm (15.4") TFT color display

Technical data
26.4 cm/10.4" TFT
800 x 600 Pixel (SVGA)
LED
340 cd/m ² typical (adjustable)
50,000 h
262,144 colors
Resistive industrial touch screen
Debian GNU/Linux
ARM® Cortex®-A8, 800 MHz
512 MB RAM
1 GB Flash
2x USB Host 2.0
1 x Ethernet (10/100 Mbps), RJ45
295 mm / 220 mm / 5 mm
287 mm / 212 mm / -
IP65 (front), IP20 (back)
0 °C ... 50 °C
Installation in front plate
DIN EN 60068-2-6
DIN EN 60068-2-27

Technical data
30.7 cm/12.1" TFT
1280 x 800 Pixel (WXGA)
LED
320 cd/m ² typical (adjustable)
50,000 h
16.7 million
Resistive industrial touch screen
Debian GNU/Linux
ARM® Cortex®-A8, 800 MHz
512 MB RAM
1 GB Flash
2x USB Host 2.0
1 x Ethernet (10/100 Mbps), RJ45
330 mm / 225 mm / 5 mm
322 mm / 217 mm / -
IP65 (front), IP20 (back)
0 °C ... 50 °C
Installation in front plate
DIN EN 60068-2-6
DIN EN 60068-2-27

Technical data
39.05 cm/15.4" TFT
1024 x 768 Pixel (XGA)
LED
360 cd/m ² typical (adjustable)
50,000 h
16.7 million
Resistive industrial touch screen
Debian GNU/Linux
ARM® Cortex®-A8, 800 MHz
512 MB RAM
1 GB Flash
2x USB Host 2.0
1 x Ethernet (10/100 Mbps), RJ45
420 mm / 297 mm / 5 mm
396 mm / 273 mm / -
IP65 (front), IP20 (back)
0 °C ... 50 °C
Installation in front plate
DIN EN 60068-2-6
DIN EN 60068-2-27

Ordering data		
Type	Order No.	Pcs. / Pkt.
WP 3105S	2400254	1

Ordering data		
Type	Order No.	Pcs. / Pkt.
WP 3120W	2400255	1

Ordering data		
Type	Order No.	Pcs. / Pkt.
WP 3150S	2400285	1

Accessories		
Type	Order No.	Pcs. / Pkt.
HMI SCB MOUNTING KIT 6	2701385	1

Accessories		
Type	Order No.	Pcs. / Pkt.
HMI SCB MOUNTING KIT 8	2701387	1

Accessories		
Type	Order No.	Pcs. / Pkt.
HMI SCB MOUNTING KIT 8	2701387	1

HMI and industrial PCs

HMI for WebVisit software

Minitouch and web panels

Web panel and minitouch devices are inexpensive operator panels for basic operation and monitoring tasks.

Features:

- Tailor-made for class 100 modular small-scale controllers
- Fast startup, thanks to Plug and Play
- **Minitouch:** alphanumeric 4-color display
- **Web panel:** full graphic color display for clear representation
- Quick and user-friendly representation of your control variables using PC Worx EXPRESS and WebVisit software tools
- Multi-user operation thanks to server/client structure
- Easy device replacement, as the project is saved on the PLC



Minitouch
7.1 cm (2.8") TFT color display

EMC



Web panel
8.9 cm (3.5")/14.5 cm (5.7")
TFT color display

CE EMC ABS UL CE RoHS REACH

Technical data

Display data	
Display	7.1 cm/2.8" TFT
Monitor resolution	320 x 240 Pixel (QVGA)
Display lighting type	LED
Brightness	280 cd/m ² , typical (adjustable)
Display backlight MTBF	40,000 h
Color spectrum	4 colors
Touch screen	Resistive industrial touch screen
Computer data	
Operating systems	Keil RTX (RTOS)
Processor	Cortex™-M3 120 MHz
RAM	96 kB SRAM
Mass storage	512 kB Flash
Interfaces	without
Network	1 x Ethernet (10/100 Mbps), RJ45
External dimensions	
Dimensions	W / H / D 96 mm / 72 mm / 60 mm
Installation dimensions	
Dimensions	W / H / D 92.8 mm / 68.7 mm / 53.5 mm
General data	
Degree of protection	IP54 (front), IP20 (back)
Ambient temperature (operation)	0 °C ... 50 °C
Mounting type	Installation in front plate
Vibration (operation)	DIN EN 60068-2-6
Shock	DIN EN 60068-2-27
EMC note	Class A product, see page 527

Technical data

WP 04T	WP 06T
8.9 cm/3.5" TFT	14.5 cm/5.7" TFT active
320 x 240 Pixel (QVGA)	
LED	
350 cd/m ² , typical (adjustable)	380 cd/m ² , typical (adjustable)
40,000 h	
65,536 colors	
Resistive industrial touch screen	
Windows CE 5.0	
RISC ARM9™ CPU; 200 MHz	
64 MB SDRAM	
32 MByte flash memory	
2x USB Host 2.0	
1 x Ethernet (10/100 Mbps), RJ45	
120 mm / 90 mm / 5 mm	168 mm / 126 mm / 5 mm
112 mm / 82 mm / 35 mm	160 mm / 118 mm / 42 mm
IP65 (front), IP20 (back)	IP65 (front), IP20 (back)
0 °C ... 50 °C	
Installation in front plate	
DIN EN 60068-2-6	
DIN EN 60068-2-27	
Class A product, see page 527	

Ordering data

Description	Type	Order No.	Pcs. / Pkt.
Minitouch			
- 7.1 cm (2.8") display	TD 1030T	2701257	1
Web panel			
- 8.9 cm (3.5") display			
- 14.5 cm (5.7") display			
- 26.4 cm (10.5") display			
- 38.1 cm (15") display			
Widescreen web panel			
- 17.8 cm (7") display			
- 22.9 cm (9") display			
Web panel, extended temperature range			
- 14.5 cm (5.7") display			
- 17.8 cm (7") display			

Ordering data

Type	Order No.	Pcs. / Pkt.
WP 04T	2913632	1
WP 06T	2913645	1

Accessories

Description	Type	Order No.	Pcs. / Pkt.
Mounting kit, including hardware for installation			
- panel installation			

Accessories

Type	Order No.	Pcs. / Pkt.
HMI SCB MOUNTING KIT 6	2701385	1



Web panel
26.4 cm (10.4")/38.1 cm (15")
TFT color display



Widescreen web panel
17.8 cm (7")/22.9 cm (9")
TFT color display



Outdoor web panel
14.5 cm (5.7")/17.8 cm (7")
TFT color display

ERC



Technical data	
WP 10T	WP 15T
26.4 cm/10.4" TFT 800 x 600 Pixel (SVGA)	38.1 cm/15" TFT 1024 x 768 Pixel (XGA)
LED	
330 cd/m ²	480 cd/m ²
50,000 h 65,536 colors	
Resistive industrial touch screen	
Windows CE 5.0 RISC ARM9™ CPU; 200 MHz 64 MB SDRAM 32 MByte flash memory 2x USB Host 2.0 1 x Ethernet (10/100 Mbps), RJ45	
295 mm / 220 mm / 5 mm	400 mm / 329 mm / 5 mm
287 mm / 212 mm / 55 mm	374 mm / 303 mm / 60 mm
IP65 (front), IP20 (back) 0 °C ... 50 °C Installation in front plate DIN EN 60068-2-6 DIN EN 60068-2-27 Class A product, see page 527	

Technical data	
WP 07T/WS	WP 09T/WS
17.8 cm/7" TFT 800 x 480 Pixel (WVGA)	22.9 cm/9" TFT 800 x 480 Pixel (WVGA)
LED	
400 cd/m ² , typical (adjustable)	240 cd/m ² , typical (adjustable)
> 50,000 h 65,536 colors	
Resistive industrial touch screen	
Windows CE 5.0 RISC ARM9™ CPU; 200 MHz 64 MB SDRAM 32 MByte flash memory 2x USB Host 2.0 1 x Ethernet (10/100 Mbps), RJ45	
203 mm / 147 mm / 5 mm	260 mm / 172 mm / 5 mm
195 mm / 139 mm / 54 mm	252 mm / 164 mm / 54 mm
IP65 (front), IP20 (back) 0 °C ... 50 °C Installation in front plate DIN EN 60068-2-6 DIN EN 60068-2-27 Class A product, see page 527	

Technical data	
WP 06T/WT	WP 07T/WT
14.5 cm/5.7" TFT active 320 x 240 Pixel (QVGA)	17.8 cm/7" TFT 800 x 480 Pixel (WVGA)
LED	
400 cd/m ² , typical (adjustable)	350 cd/m ² , typical (adjustable)
40,000 h 65,536 colors	
Resistive industrial touch screen	
Windows CE 5.0 RISC ARM9™ CPU; 184 MHz 128 MB SDRAM 64 MB Flash 2x USB Host 2.0 1 x Ethernet (10/100 Mbps), RJ45	
195 mm / 153 mm / 5 mm	234 mm / 173 mm / 5 mm
161 mm / 119 mm / 42 mm	200 mm / 140 mm / 42 mm
IP67 (front), IP20 (back) -20 °C ... 70 °C Installation in front plate DIN EN 60068-2-6 DIN EN 60068-2-27	

Ordering data		
Type	Order No.	Pcs. / Pkt.
WP 10T	2700934	1
WP 15T	2700935	1
WP 07T/WS	2700307	1
WP 09T/WS	2700309	1
WP 06T/WT	2400163	1
WP 07T/WT	2400164	1

Ordering data		
Type	Order No.	Pcs. / Pkt.
WP 10T	2700934	1
WP 15T	2700935	1
WP 07T/WS	2700307	1
WP 09T/WS	2700309	1
WP 06T/WT	2400163	1
WP 07T/WT	2400164	1

Ordering data		
Type	Order No.	Pcs. / Pkt.
WP 10T	2700934	1
WP 15T	2700935	1
WP 07T/WS	2700307	1
WP 09T/WS	2700309	1
WP 06T/WT	2400163	1
WP 07T/WT	2400164	1

Accessories		
Type	Order No.	Pcs. / Pkt.
HMI SCB MOUNTING KIT 6	2701385	1

Accessories		
Type	Order No.	Pcs. / Pkt.
HMI SCB MOUNTING KIT 8	2701387	1

Accessories		
Type	Order No.	Pcs. / Pkt.
HMI SCB MOUNTING KIT 8	2701387	1

Touch panels

Thanks to the numerous interfaces, drivers, and display sizes, touch panels from Phoenix Contact can be optimally adapted to your requirements. Licenses are already included for the Visu+ software and the OPC server.

Your advantages:

- Save costs and increase service life, thanks to LED backlighting that can be adjusted directly via buttons
- Increase system availability, thanks to temperature and voltage monitoring
- Quick response in the event of an alarm with integrated buzzer (85 dB)
- Global: additional fonts are easy to install
- Available with PROFIBUS DP, MPI, CANopen, and serial interface as an option
- Expansion with external Flash mass storage



14.5 cm (5.7") monochrome display



14.5 cm (5.7") TFT color display



Technical data	
Display data	
Display	14.5 cm/5.7" TFT active
Monitor resolution	320 x 240 Pixel (QVGA)
Display lighting type	LED
Brightness	250 cd/m ² , typical (adjustable)
Display backlight MTBF	40,000 h
Color spectrum	256-step grayscale
Touch screen	Resistive industrial touch screen
Computer data	
Operating systems	Windows CE 6.0
Processor	Xscale® PXA320, 806 MHz
RAM	128 MB SDRAM
Mass storage	1 GB Flash
Interfaces	2x USB Host 1.1, 1x Compact Flash®
Network	1 x Ethernet (10/100 Mbps), RJ45
External dimensions	
Dimensions	W / H / D 203 mm / 147 mm / 5 mm
Installation dimensions	
Dimensions	W / H / D 195 mm / 139 mm / 49 mm approximately 55 mm with fieldbus interface
General data	
Degree of protection	IP65 (front), IP20 (back)
Ambient temperature (operation)	0 °C ... 50 °C
Mounting type	Installation in front plate
Vibration (operation)	DIN EN 60068-2-6
Shock	DIN EN 60068-2-27
EMC note	Class A product, see page 527

Technical data	
Display data	
Display	14.5 cm/5.7" TFT active
Monitor resolution	320 x 240 Pixel (QVGA)
Display lighting type	LED
Brightness	350 cd/m ² , typical (adjustable)
Display backlight MTBF	40,000 h
Color spectrum	65,536 colors
Touch screen	Resistive industrial touch screen
Computer data	
Operating systems	Windows CE 6.0
Processor	Xscale® PXA320, 806 MHz
RAM	128 MB SDRAM
Mass storage	1 GB Flash
Interfaces	2x USB Host 1.1, 1x Compact Flash®
Network	1 x Ethernet (10/100 Mbps), RJ45
External dimensions	
Dimensions	W / H / D 203 mm / 147 mm / 5 mm
Installation dimensions	
Dimensions	W / H / D 195 mm / 139 mm / 49 mm approximately 55 mm with fieldbus interface
General data	
Degree of protection	IP65 (front), IP20 (back)
Ambient temperature (operation)	0 °C ... 50 °C
Mounting type	Installation in front plate
Vibration (operation)	DIN EN 60068-2-6
Shock	DIN EN 60068-2-27
EMC note	Class A product, see page 527

Ordering data		
Type	Order No.	Pcs. / Pkt.
TP 3057M	2700901	1
TP 3057M PB	2700902	1
TP 3057M MPI	2700903	1
TP 3057M CO	2700904	1
TP 3057M SER	2700905	1

Ordering data		
Type	Order No.	Pcs. / Pkt.
TP 3057T	2700906	1
TP 3057T PB	2700907	1
TP 3057T MPI	2700908	1
TP 3057T CO	2700909	1
TP 3057T SER	2700910	1

Accessories		
Type	Order No.	Pcs. / Pkt.
HMI SCB MOUNTING KIT 6	2701385	1

Accessories		
Type	Order No.	Pcs. / Pkt.
HMI SCB MOUNTING KIT 6	2701385	1

Accessories		
Type	Order No.	Pcs. / Pkt.
HMI SCB MOUNTING KIT 6	2701385	1



17.8 cm (7") TFT color display



26.4 cm (10.4") TFT color display



30.7 cm (12.1") TFT color display



Technical data
17.8 cm/7" TFT 800 x 480 Pixel (WVGA) LED 350 cd/m ² , typical (adjustable) 40,000 h 65,536 colors Resistive industrial touch screen
Windows CE 6.0 Xscale® PXA320, 806 MHz 128 MB SDRAM 1 GB Flash 2x USB Host 1.1, 1x Compact Flash® 1 x Ethernet (10/100 Mbps), RJ45
203 mm / 147 mm / 5 mm
195 mm / 139 mm / 49 mm approximately 55 mm with fieldbus interface
IP65 (front), IP20 (back) 0 °C ... 50 °C Installation in front plate DIN EN 60068-2-6 DIN EN 60068-2-27 Class A product, see page 527

Technical data
26.4 cm/10.4" TFT 800 x 600 Pixel (SVGA) LED 350 cd/m ² , typical (adjustable) 50,000 h 65,536 colors Resistive industrial touch screen
Windows CE 6.0 Xscale® PXA320, 806 MHz 128 MB SDRAM 1 GB Flash 2x USB Host 1.1, 1x Compact Flash® 1 x Ethernet (10/100 Mbps), RJ45
295 mm / 220 mm / 5 mm
287 mm / 212 mm / 56 mm approximately 61 mm with fieldbus interface
IP65 (front), IP20 (back) 0 °C ... 50 °C Installation in front plate DIN EN 60068-2-6 DIN EN 60068-2-27 Class A product, see page 527

Technical data
30.7 cm/12.1" TFT 800 x 600 Pixel (SVGA) LED 300 cd/m ² , typical (adjustable) 50,000 h 65,536 colors Resistive industrial touch screen
Windows CE 6.0 Xscale® PXA320, 806 MHz 128 MB SDRAM 1 GB Flash 2x USB Host 1.1, 1x Compact Flash® 1 x Ethernet (10/100 Mbps), RJ45
340 mm / 270 mm / 5 mm
315 mm / 243.5 mm / 60 mm approximately 65 mm with fieldbus interface
IP65 (front), IP20 (back) 0 °C ... 50 °C Installation in front plate DIN EN 60068-2-6 DIN EN 60068-2-27 Class A product, see page 527

Ordering data		
Type	Order No.	Pcs. / Pkt.
TP 3070T	2700911	1
TP 3070T PB	2700912	1
TP 3070T MPI	2700913	1
TP 3070T CO	2700914	1
TP 3070T SER	2700915	1

Ordering data		
Type	Order No.	Pcs. / Pkt.
TP 3105T	2700916	1
TP 3105T PB	2700917	1
TP 3105T MPI	2700918	1
TP 3105T CO	2700919	1
TP 3105T SER	2700920	1

Ordering data		
Type	Order No.	Pcs. / Pkt.
TP 3121T	2700921	1
TP 3121T PB	2700922	1
TP 3121T MPI	2700923	1
TP 3121T CO	2700924	1
TP 3121T SER	2700925	1

Accessories		
Type	Order No.	Pcs. / Pkt.
HMI SCB MOUNTING KIT 6	2701385	1

Accessories		
Type	Order No.	Pcs. / Pkt.
HMI SCB MOUNTING KIT 8	2701387	1

Accessories		
Type	Order No.	Pcs. / Pkt.
HMI SCB MOUNTING KIT 8	2701387	1

Touch panels

Benefit from up to 10% faster screen change and response time. You can use the new HMI devices for the Visu+ visualization software to design complex operating and monitoring interfaces that run smoothly.

Your advantages:

- Powerful and versatile, thanks to the new processor generation and integrated Visu+ visualization software
- Flexible connection, thanks to various drivers, even for third-party systems
- Optional mobile system access with the Visu+ mobile app
- Save costs for acoustic signaling devices, thanks to integrated buzzer (85 dB)
- Fast diagnostics, thanks to easy IP address assignment and active connection monitoring according to PROFINET Conformance Class B

new

new



14.5 cm (5.7") TFT color display



17.8 cm (7") TFT color display

Display data	
Display	
Monitor resolution	
Display lighting type	
Brightness	
Display backlight MTBF	
Color spectrum	
Touch screen	
Computer data	
Operating systems	
Processor	
RAM	
Mass storage	
Interfaces	
Network	
External dimensions	
Dimensions	W / H / D
Installation dimensions	
Dimensions	W / H / D
General data	
Degree of protection	
Ambient temperature (operation)	
Mounting type	
Vibration (operation)	
Shock	

Technical data	
TP 3057Q	TP 3057V
14.5 cm/5.7" TFT active	
320 x 240 Pixel (QVGA)	640 x 480 Pixel (VGA)
LED	
400 cd/m ² , typical (adjustable)	
40,000 h	
65,536 colors	262,144 colors
Resistive industrial touch screen	
Windows Embedded Compact 7	
ARM® Cortex®-A8, 800 MHz	
512 MB RAM	
1 GB Flash	
2x USB host 2.0	2x USB Host 2.0
1 x Ethernet (10/100 Mbps), RJ45	
203 mm / 147 mm / 5 mm	
168 mm / 126 mm / 5 mm	
195 mm / 139 mm / -	
160 mm / 118 mm / -	
Installation cutout	
IP65 (front), IP20 (back)	
0 °C ... 50 °C	
Installation in front plate	
DIN EN 60068-2-6	
DIN EN 60068-2-27	

Technical data	
17.8 cm/7" TFT	
800 x 480 Pixel (WVGA)	
LED	
350 cd/m ² , typical (adjustable)	
40,000 h	
262,144 colors	
Resistive industrial touch screen	
Windows Embedded Compact 7	
ARM® Cortex®-A8, 800 MHz	
512 MB RAM	
1 GB Flash	
2x USB Host 2.0	
1 x Ethernet (10/100 Mbps), RJ45	
203 mm / 147 mm / 5 mm	
195 mm / 139 mm / -	
Installation cutout	
IP65 (front), IP20 (back)	
0 °C ... 50 °C	
Installation in front plate	
DIN EN 60068-2-6	
DIN EN 60068-2-27	

Description
Touch panel with graphics-capable TFT display, 1 x Ethernet, 2 x USB, integrated AX OPC server and integrated runtime of the Visu+ visualization software
- 14.5 cm (5.7") display
- 14.5 cm (5.7") display
- 17.8 cm (7") display
- 26.4 cm (10.4") display
- 30.7 cm (12.1") display
- 30.7 cm (12.1") display
- 39.05 cm (15.4") display

Ordering data		
Type	Order No.	Pcs. / Pkt.
TP 3057Q	2400452	1
TP 3057V	2400453	1

Ordering data		
Type	Order No.	Pcs. / Pkt.
TP 3070W	2400454	1

Mounting kit , including hardware for installation
- panel installation

Accessories		
Type	Order No.	Pcs. / Pkt.
HMI SCB MOUNTING KIT 6	2701385	1

Accessories		
Type	Order No.	Pcs. / Pkt.
HMI SCB MOUNTING KIT 6	2701385	1

new



26.4 cm (10.4") TFT color display

new



30.7 cm (12.1") TFT color display

new



39.05 cm (15.4") TFT color display

Technical data

26.4 cm/10.4" TFT
800 x 600 Pixel (SVGA)
LED
340 cd/m² typical (adjustable)
50,000 h
262,144 colors
Resistive industrial touch screen

Windows Embedded Compact 7
ARM® Cortex®-A8, 800 MHz
512 MB RAM
1 GB Flash
2x USB Host 2.0
1 x Ethernet (10/100 Mbps), RJ45

295 mm / 220 mm / 5 mm

287 mm / 212 mm / -
Installation cutout

IP65 (front), IP20 (back)
0 °C ... 50 °C
Installation in front plate
DIN EN 60068-2-6
DIN EN 60068-2-27

Technical data

TP 3121S

TP 3120W

30.7 cm/12.1" TFT
800 x 600 Pixel (SVGA) 1280 x 800 Pixel (WXGA)
LED
320 cd/m² typical (adjustable)
40,000 h 50,000 h
65,536 colors 262,144 colors
Resistive industrial touch screen

Windows Embedded Compact 7
ARM® Cortex®-A8, 800 MHz
512 MB RAM
1 GB Flash
2x USB Host 2.0
1 x Ethernet (10/100 Mbps), RJ45

340 mm / 370 mm / 5 mm 330 mm / 225 mm / 5 mm

313 mm / 243 mm / - 322 mm / 217 mm / -
Installation cutout

IP65 (front), IP20 (back)
0 °C ... 50 °C
Installation in front plate
DIN EN 60068-2-6
DIN EN 60068-2-27

Technical data

39.05 cm/15.4" TFT
1024 x 768 Pixel (XGA)
LED
480 cd/m²
50,000 h
262,144 colors
Resistive industrial touch screen

Windows Embedded Compact 7
ARM® Cortex®-A8, 800 MHz
512 MB RAM
1 GB Flash
2x USB Host 2.0
1 x Ethernet (10/100 Mbps), RJ45

400 mm / 329 mm / 5 mm

373 mm / 301 mm / -
Installation cutout

IP65 (front), IP20 (back)
0 °C ... 50 °C
Installation in front plate
DIN EN 60068-2-6
DIN EN 60068-2-27

Ordering data

Type	Order No.	Pcs. / Pkt.
TP 3105S	2400455	1

Ordering data

Type	Order No.	Pcs. / Pkt.
TP 3121S	2400456	1
TP 3120W	2400457	1

Ordering data

Type	Order No.	Pcs. / Pkt.
TP 3150S	2400458	1

Accessories

HMI SCB MOUNTING KIT 6	2701385	1
------------------------	---------	---

Accessories

HMI SCB MOUNTING KIT 8	2701387	1
------------------------	---------	---

Accessories

HMI SCB MOUNTING KIT 8	2701387	1
------------------------	---------	---

Touch panels

Powerful touch panels with PC platform are the ideal solution for graphics-intensive visualization applications. The devices in the 5000 series are ideal for use in large networked machines and systems. Thanks to technical properties such as the X86 platform with Windows CE, the HMIs offer a fair price/performance ratio. You can therefore even implement intelligent operating concepts in complex systems.

Additional features:

- Cost-effective solution, since there are no additional costs for SCADA runtime: unlimited runtime license for Visu+ RT and AX OPC Server included
- Ethernet-based drivers available for connection to third-party systems
- Additional monitor connection possible by using the VGA interface (multi-user function)
- Remote access to user interface via web-capable devices thanks to Visu+ web client functionality
- Easy to maintain thanks to external data backup and event-oriented e-mail/SMS messaging
- High system availability thanks to OPC with redundancy support
- Particularly reliable thanks to integrated connection for uninterruptible power supply (UPS)



30.7 cm (12.1") TFT color display



Display data	
Display	
Monitor resolution	
Display lighting type	
Brightness	
Display backlight MTBF	
Color spectrum	
Touch screen	
Computer data	
Operating systems	
Processor	
RAM	
Mass storage	
Interfaces	
Network	
External dimensions	
Dimensions	W / H / D
Installation dimensions	
Dimensions	W / H / D
General data	
Degree of protection	
Ambient temperature (operation)	
Mounting type	
Vibration (operation)	
Shock	

Technical data	
30.7 cm/12.1" TFT	
800 x 600 Pixel (SVGA)	
CCFL	
400 cd/m ² , typical (adjustable)	
50,000 h	
65,536 colors	
Resistive industrial touch screen	
Windows CE 6.0	
Intel® Atom™ N270 1.6 GHz	
1 GB DDR	
CompactFlash®, 2 GB	
COM 1 (RS-232), 1x VGA, 4x USB, 2x CompactFlash®	
2x Ethernet (10/100/1000 Mbps), RJ45	
365 mm / 282 mm / 10 mm	
334 mm / 253 mm / 94 mm	
IP65 (front), IP20 (back)	
-20 °C ... 55 °C	
Installation in front plate	
DIN EN 60068-2-6	
15g, 11 ms according to IEC 60068-2-27	

Description
Touch panel - Atom 1.6 GHz

Ordering data		
Type	Order No.	Pcs. / Pkt.
TP 5120T	2700621	1

Stylus for touch screens
USB memory stick , memory 2 GB, USB 2.0
Mounting kit , including hardware for installation
- panel installation

Accessories		
Type	Order No.	Pcs. / Pkt.
TOUCH PEN	2701379	1
2 GB USB STICK	2701382	1
VL PANEL MOUNTING KIT	2913159	1



38.1 cm (15") color TFT display



43.2 cm (17") TFT color display



Technical data
38.1 cm/15" TFT
1024 x 768 Pixel (XGA)
CCFL
350 cd/m ² , typical (adjustable)
50,000 h
65,536 colors
Resistive industrial touch screen
Windows CE 6.0
Intel® Atom™ N270 1.6 GHz
1 GB DDR
CompactFlash®, 2 GB
COM 1 (RS-232), 1x VGA, 4x USB, 2x CompactFlash®
2x Ethernet (10/100/1000 Mbps), RJ45
410 mm / 309 mm / 10 mm
386.6 mm / 285 mm / 96 mm
IP65 (front), IP20 (back)
-20 °C ... 55 °C
Installation in front plate
DIN EN 60068-2-6
15g, 11 ms according to IEC 60068-2-27

Technical data
43,2 cm / 17"-TFT
1280 x 1024 Pixel (SXGA)
CCFL
350 cd/m ² , typical (adjustable)
50,000 h
65,536 colors
Resistive industrial touch screen
Windows CE 6.0
Intel® Atom™ N270 1.6 GHz
1 GB DDR
CompactFlash®, 2 GB
COM 1 (RS-232), 1x VGA, 4x USB, 2x CompactFlash®
2x Ethernet (10/100/1000 Mbps), RJ45
452 mm / 356.5 mm / 10 mm
424 mm / 329.5 mm / 99 mm
IP65 (front), IP20 (back)
-20 °C ... 50 °C
Installation in front plate
DIN EN 60068-2-6
15g, 11 ms according to IEC 60068-2-27

Ordering data		
Type	Order No.	Pcs. / Pkt.
TP 5150T	2700622	1

Ordering data		
Type	Order No.	Pcs. / Pkt.
TP 5170T	2700623	1

Accessories		
	Order No.	Pcs. / Pkt.
TOUCH PEN	2701379	1
2 GB USB STICK	2701382	1
VL PANEL MOUNTING KIT	2913159	1

Accessories		
	Order No.	Pcs. / Pkt.
TOUCH PEN	2701379	1
2 GB USB STICK	2701382	1
VL PANEL MOUNTING KIT	2913159	1

Touch panels

HMI devices for maritime applications are the reliable and robust solution for demanding applications on ships. The touch panels are specifically tested and approved for shipbuilding.

Your advantages:

- Tested quality - certified according to GL, LR, BV, DNV, and ABS
- Flexible communication, even with third-party systems, thanks to numerous drivers
- Save costs and increase service life, thanks to LED backlighting that can be adjusted directly via buttons
- Increase system availability, thanks to temperature and voltage monitoring
- Save costs for acoustic signaling devices: integrated buzzer
- Global use: additional fonts are easy to install
- Cost-effective solution, since there are no additional costs for SCADA runtime: unlimited runtime license for Visu+ RT and AX OPC Server included



17.8 cm (7") TFT color display



Display data	
Display	17.8 cm/7" TFT
Monitor resolution	800 x 480 Pixel (WVGA)
Display lighting type	LED
Brightness	350 cd/m ² , typical (adjustable)
Display backlight MTBF	50,000 h
Color spectrum	65,536 colors
Touch screen	Resistive industrial touch screen
Computer data	
Operating systems	Windows CE 6.0
Processor	Xscale® PXA320, 806 MHz
RAM	128 MB SDRAM
Mass storage	1 GB Flash
Interfaces	2x USB Host 1.1, 1x Compact Flash®
Network	1 x Ethernet (10/100 Mbps), RJ45
External dimensions	
Dimensions	W / H / D 203 mm / 165 mm / 5 mm
Installation dimensions	
Dimensions	W / H / D 195 mm / 157 mm / 56 mm
General data	
Degree of protection	IP65 (front), IP20 (back)
Ambient temperature (operation)	0 °C ... 55 °C
Mounting type	Installation in front plate
Vibration (operation)	DIN EN 60068-2-6
Shock	DIN EN 60068-2-27
EMC note	Class A product, see page 527

Technical data		
17.8 cm/7" TFT		
800 x 480 Pixel (WVGA)		
LED		
350 cd/m ² , typical (adjustable)		
50,000 h		
65,536 colors		
Resistive industrial touch screen		
Windows CE 6.0		
Xscale® PXA320, 806 MHz		
128 MB SDRAM		
1 GB Flash		
2x USB Host 1.1, 1x Compact Flash®		
1 x Ethernet (10/100 Mbps), RJ45		
IP65 (front), IP20 (back)		
0 °C ... 55 °C		
Installation in front plate		
DIN EN 60068-2-6		
DIN EN 60068-2-27		
Class A product, see page 527		

Description
Touch panel with graphics-capable display, for maritime applications

Ordering data		
Type	Order No.	Pcs. / Pkt.
TP 07T/M 211	2701452	1

Stylus for touch screens
USB memory stick , memory 2 GB, USB 2.0
CMOS battery
Mounting kit , including hardware for installation
- panel installation
Protective foil for touch screen

Accessories		
Type	Order No.	Pcs. / Pkt.
TOUCH PEN	2701379	1
2 GB USB STICK	2701382	1
HMI BATTERY	2701383	1
HMI SCB MOUNTING KIT 6	2701385	1
7" DISPLAY PROTECTIVE FOIL	2701374	1



26.4 cm (10.4") TFT color display



30.7 cm (12.1") TFT color display



38.1 cm (15") color TFT display



Technical data
26.4 cm/10.4" TFT
640 x 480 Pixel (VGA)
LED
350 cd/m ² , typical (adjustable)
50,000 h
65,536 colors
Resistive industrial touch screen
Windows CE 6.0
Xscale® PXA320, 806 MHz
128 MB SDRAM
1 GB Flash
2x USB Host 1.1, 1x Compact Flash®
1 x Ethernet (10/100 Mbps), RJ45
328 mm / 265 mm / 5 mm
303 mm / 238 mm / 57 mm
IP65 (front), IP20 (back)
0 °C ... 55 °C
Installation in front plate
DIN EN 60068-2-6
DIN EN 60068-2-27
Class A product, see page 527

Technical data
30.7 cm/12.1" TFT
800 x 600 Pixel (SVGA)
LED
300 cd/m ² , typical (adjustable)
50,000 h
65,536 colors
Resistive industrial touch screen
Windows CE 6.0
Xscale® PXA320, 806 MHz
128 MB SDRAM
1 GB Flash
2x USB Host 1.1, 1x Compact Flash®
1 x Ethernet (10/100 Mbps), RJ45
340 mm / 285 mm / 5 mm
315 mm / 259 mm / 62 mm
IP65 (front), IP20 (back)
0 °C ... 55 °C
Installation in front plate
DIN EN 60068-2-6
DIN EN 60068-2-27
Class A product, see page 527

Technical data
38.1 cm/15" TFT
1024 x 768 Pixel (XGA)
LED
480 cd/m ²
50,000 h
256 colors
Resistive industrial touch screen
Windows CE 6.0
Xscale® PXA320, 806 MHz
128 MB SDRAM
1 GB Flash
2x USB Host 1.1, 1x Compact Flash®
1 x Ethernet (10/100 Mbps), RJ45
400 mm / 338 mm / 5 mm
373 mm / 312 mm / 62 mm
IP65 (front), IP20 (back)
0 °C ... 55 °C
Installation in front plate
DIN EN 60068-2-6
DIN EN 60068-2-27
Class A product, see page 527

Ordering data		
Type	Order No.	Pcs. / Pkt.
TP 10T/M 211	2701843	1

Ordering data		
Type	Order No.	Pcs. / Pkt.
TP 12T/M 211	2701844	1

Ordering data		
Type	Order No.	Pcs. / Pkt.
TP 15T/M 211	2701845	1

Accessories		
Type	Order No.	Pcs. / Pkt.
TOUCH PEN	2701379	1
2 GB USB STICK	2701382	1
HMI BATTERY	2701383	1
HMI SCB MOUNTING KIT 8	2701387	1
10,4" DISPLAY PROTECTIVE FOIL	2701376	1

Accessories		
Type	Order No.	Pcs. / Pkt.
TOUCH PEN	2701379	1
2 GB USB STICK	2701382	1
HMI BATTERY	2701383	1
HMI SCB MOUNTING KIT 8	2701387	1
12,1" DISPLAY PROTECTIVE FOIL	2701377	1

Accessories		
Type	Order No.	Pcs. / Pkt.
TOUCH PEN	2701379	1
2 GB USB STICK	2701382	1
HMI BATTERY	2701383	1
HMI SCB MOUNTING KIT 8	2701387	1
15,1" DISPLAY PROTECTIVE FOIL	2701378	1

Box PCs for wall or DIN rail mounting

Box PCs are compact, easy to maintain, and powerful. They impress above all in sophisticated applications such as the measurement, control, and testing of process and machine data or distributed visualizations in conjunction with remote monitors. Various mounting options and scalable performance make box PCs the ideal platform for machine building and systems manufacturing.

Your advantages:

- High system availability, thanks to a fanless design which is suitable for industrial applications and the absence of moving parts
- Versatile use, thanks to various mounting options, e.g., on the DIN rail
- Energy-efficient Intel® Atom™ and Celeron® processors
- Large-scale compatibility, thanks to open IT standards, numerous interfaces and operating systems
- Particularly easy to maintain, thanks to easily accessible components in the IPC housing
- Can be used in harsh environments, thanks to the extended temperature range (-40°C to +65°C) and shock resistance up to 20g

Additional features:

- Configurable based upon customer requirements
- System protection through the use of embedded operating systems



Box PC with extended temperature range



Computer data	
Processor (configuration option)	
RAM (configuration option)	
Mass storage (configuration option)	
Interfaces	
Slots	
Monitor output	
Network	
Power supply unit	
General data	
Dimensions	W / H / D
Degree of protection	
Ambient temperature (operation)	
Permissible humidity (operation)	
Mounting type (configuration option)	
Vibration (operation)	
Shock	
EMC note	

Technical data	
Processor (configuration option)	Intel® Atom™ Z510PT 1.1 GHz
RAM (configuration option)	1 GB DDR2 SODIMM (W.T.) 2 GB DDR2 SODIMM (W.T.)
Mass storage (configuration option)	1 GB CF card 2 GB CF card 4 GB CF card 8 GB CF card 16 GB CF card 32 GB CF card

1x COM (RS-232/422/485)
6x USB 2.0
without slots
VGA
2x Ethernet (10/100/1000 Mbps), RJ45
24 V DC ±20%

155 mm / 125 mm / 49 mm
IP20
-40 °C ... 65 °C
0 % ... 95 % (non-condensing)
Wall mounting
DIN rail mounting
DIN EN 60068-2-6
20g, 11 ms according to IEC 60068-2-27

Ordering data	
Type	Order No.
Industrial computer - Configurable	2700773
Industrial computer - Preconfigured with 2 GB RAM, no mass storage or operating system	

Accessories	
Type	Order No.
CompactFlash® card - 1 GB	2913155
- 2 GB	2913156
- 4 GB	2913157
- 8 GB	2913158
DisplayPort to VGA video adapter bfg	
DisplayPort to DVI-i video adapter	

Ordering data		
Type	Order No.	Pcs. / Pkt.
VL BPC MINI	2700773	1

Accessories		
Type	Order No.	Pcs. / Pkt.
VL 1 GB CF	2913155	1
VL 2 GB CF	2913156	1
VL 4 GB CF	2913157	1
VL 8 GB CF	2913158	1
DisplayPort to VGA video adapter bfg		
DisplayPort to DVI-i video adapter		



Box PC with Intel® Atom™ processor



Box PC with Intel® Celeron® processor



Technical data
Intel® Atom™ N455 1.66 GHz 2 GB DDR3 SODIMM
without mass storage 1 GB CF card 2 GB CF card 4 GB CF card 8 GB CF card 16 GB CF card 32 GB CF card
1x COM (RS-232/422/485) 2x COM (RS-232) 4x USB 2.0
without slots VGA 2x Ethernet (10/100/1000 Mbps), RJ45 24 V DC ±20%
155 mm / 145 mm / 49 mm IP20 0 °C ... 50 °C 5 % ... 95 % Wall mounting DIN rail mounting DIN EN 60068-2-6 15g, 11 ms according to IEC 60068-2-27 Class A product, see page 527

Technical data
Intel® Celeron® N2930 1.83 GHz/2.16 GHz 2 GB DDR3 SODIMM 4 GB DDR3 SODIMM
without mass storage 4 GB CFast® card 8 GB CFast® card 16 GB CFast® card 32 GB CFast® card 16 GB SSD (SLC) 32 GB SSD (SLC) 80 GB SSD (MLC) 160 GB SSD (MLC) 320 GB HDD 2.5" SATA
1x COM (RS-232/422/485) 2x COM (RS-232) 3x USB 2.0 2x USB 3.0
without slots 2x DisplayPort 2x Ethernet (10/100/1000 Mbps), RJ45 24 V DC ±20%
162 mm / 146.2 mm / 49 mm IP20 -20 °C ... 50 °C 5 % ... 95 % (non-condensing) Wall mounting DIN rail mounting DIN EN 60068-2-6 15g, 11 ms according to IEC 60068-2-27

Ordering data		
Type	Order No.	Pcs. / Pkt.
VL BPC 1000	2701291	1
VL BPC 1001	2701290	1

Ordering data		
Type	Order No.	Pcs. / Pkt.
BL BPC 2000	2701712	1
BL BPC 2001	2701711	1

Accessories		
VL 1 GB CF	2913155	1
VL 2 GB CF	2913156	1
VL 4 GB CF	2913157	1
VL 8 GB CF	2913158	1

Accessories		
DP TO VGA ADPTR	2400173	1
DP TO DVI ADPTR	2400174	1

VL2 box PCs are a new range of industrial PCs: they are fanless box PCs with the latest processors in various performance classes. Configure the box PCs using numerous options such as RAID. The maintenance-friendly design also enables easy handling during operation.

Your advantages:

- Extremely robust, thanks to the industrial, fanless design
- Maintenance-friendly with access to all important components
- Can be extended via PCI/PCIe slot
- High data security, thanks to 2 forms of mass storage and RAID support
- Even supports large displays up to 4K and multi-display



Configurable box PC with Intel® Celeron® N2930 technology

Technical data			
Computer data	Intel® Celeron® N2930 1.83 GHz/2.16 GHz 4 GB DDR3 SODIMM 8 GB DDR3 SODIMM		
Processor (configuration option)			
RAM (configuration option)			
Mass storage (configuration option)	without mass storage 4 GB SSD (SLC) 8 GB SSD (SLC) 16 GB SSD (SLC) 32 GB SSD (SLC) 80 GB SSD (MLC) 160 GB SSD (MLC) 320 GB HDD 2.5" SATA		
RAID system	-		
Interfaces	1x COM (RS-232/422/485) 4x USB 2.0		
Slots	1x PCI/PCIe		
Monitor output	2x DisplayPort		
Network	2x Ethernet (10/100/1000 Mbps), RJ45		
Power supply unit	24 V DC ±20%		
General data			
Degree of protection	IP40		
Ambient temperature (operation)	0 °C ... 50 °C		
Permissible humidity (operation)	5 % ... 95 % (non-condensing)		
Mounting type (configuration option)	Bookshelf mounting Wall mounting		
Vibration (operation)	DIN EN 60068-2-6		
Shock	15g, 11 ms according to IEC 60068-2-27		
Ordering data			
Description	Type	Order No.	Pcs. / Pkt.
Industrial computer	VL2 BPC 2000	2400332	1

new



**Configurable box PC with
Intel® Core™ i5-4300U technology**

Technical data

Intel® Core™ i5-4300U 2.90 GHz
 4 GB DDR3 SODIMM
 8 GB DDR3 SODIMM
 16 GB DDR3 SODIMM
 without mass storage
 4 GB SSD (SLC)
 8 GB SSD (SLC)
 16 GB SSD (SLC)
 32 GB SSD (SLC)
 80 GB SSD (MLC)
 160 GB SSD (MLC)
 320 GB HDD 2.5" SATA
 0, 1
 1x COM (RS-232/422/485)
 2x USB 2.0
 2x USB 3.0
 1x PCI/PCIe
 2x DisplayPort
 2x Ethernet (10/100/1000 Mbps), RJ45
 24 V DC ±20%

IP40
 0 °C ... 50 °C
 5% ... 95% (non-condensing)
 Bookshelf mounting
 Wall mounting
 DIN EN 60068-2-6
 15g, 11 ms according to IEC 60068-2-27

Ordering data

Type	Order No.	Pcs. / Pkt.
VL2 BPC 7000	2400333	1

Industrial PCs

Valueline box PCs

The proven box PCs in the Valueline range are powerful IPC solutions with maximum configuration options. Always optimally tailored to your requirements for on-site visualization, measurement, and control directly in the system.

Additional features:

- Energy-efficient Intel® ATOM™ to Core™ i7 processors
- Fanless design
- Mounting in “bookshelf” form or wall mounting
- Easily removable HDD (hard disk drive) and SSD (solid state drive)
- Large-scale compatibility, thanks to open IT standards, numerous interfaces and operating systems
- Optional expansion slots for installation of PCI cards

Notes:
 1) Configuration options can affect the operating temperature. See user manual for details.



Box PC with or without PCI

Computer data	
Processor (configuration option)	
RAM (configuration option)	
Mass storage (configuration option)	
Optical drive (configuration option)	
Interfaces	
Slots	
Monitor output	
Network	
Power supply unit	
General data	
Degree of protection (configuration options)	
Ambient temperature (operation)	
Permissible humidity (operation)	
Mounting type (configuration option)	
Vibration (operation)	
Shock	
EMC note	



Technical data	
Processor (configuration option)	Intel® Atom™ N270 1.6 GHz Intel® Celeron® M ULV 423 1.01 GHz Intel® Core™2 Duo L7400 1.5 GHz Intel® Atom™ Enhanced 1.6 GHz
RAM (configuration option)	512 MB DDR SODIMM 1 GB DDR SODIMM 2 GB DDR SODIMM 3 GB DDR SODIMM
Mass storage (configuration option)	without mass storage 512 MB CF card 1 GB CF card 2 GB CF card 4 GB CF card 8 GB CF card 16 GB CF card 32 GB CF card 16 GB SSD (SLC) 32 GB SSD (SLC) 80 GB SSD (MLC) 160 GB SSD (MLC) 320 GB HDD 2.5" SATA 250 GB HDD 2.5" SATA
Optical drive (configuration option)	DVD-RW Without drive
Interfaces	1x COM (RS-232) 4x USB 2.0 2x CompactFlash®
Slots	2x PCI without slots
Monitor output	VGA, DVI-D (not available with Atom processors)
Network	2x Ethernet (10/100/1000 Mbps), RJ45
Power supply unit	24 V DC ±20%
General data	
Degree of protection (configuration options)	IP65 (front), IP20 (back) IP20
Ambient temperature (operation)	-20 °C ... 55 °C ¹⁾
Permissible humidity (operation)	5 % ... 95 % (non-condensing)
Mounting type (configuration option)	Bookshelf mounting Wall mounting
Vibration (operation)	DIN EN 60068-2-6
Shock	15g, 11 ms according to IEC 60068-2-27

Description	
Industrial computer	

Ordering data		
Type	Order No.	Pcs. / Pkt.
VALUELINE IPC	2913108	1

new



Box PC with Intel® Core™ i7 technology



Box PC with Intel® Core™ i3 technology

Ex:

Technical data

Intel® Core™ i7-660UE 1.33 GHz
 Intel® Core™ i7-610E 2.53 GHz
 Intel® Core™ i7-660UE 1.33 GHz

2 GB DDR3 SODIMM
 4 GB DDR3 SODIMM
 8 GB DDR3 SODIMM

without mass storage
 1 GB CF card
 2 GB CF card
 4 GB CF card
 8 GB CF card
 16 GB CF card
 32 GB CF card
 16 GB SSD (SLC)
 32 GB SSD (SLC)
 80 GB SSD (MLC)
 160 GB SSD (MLC)
 320 GB HDD 2.5" SATA

Without drive

1x COM (RS-232)
 4x USB 2.0
 1x CompactFlash®
 without slots

DVI-I

2x Ethernet (10/100/1000 Mbps), RJ45
 24 V DC ±20%

IP65 (front), IP20 (back)
 IP20
 0 °C ... 45 °C
 5 % ... 95 % (non-condensing)
 Bookshelf mounting
 Wall mounting
 DIN EN 60068-2-6
 15g, 11 ms according to IEC 60068-2-27
 Class A product, see page 527

Technical data

Intel® Core™ i3-4010U 1.70 GHz

4 GB DDR3 SODIMM
 8 GB DDR3 SODIMM
 16 GB DDR3 SODIMM

without mass storage
 16 GB SSD (SLC)
 32 GB SSD (SLC)
 80 GB SSD (MLC)
 160 GB SSD (MLC)
 4 GB CFast® card
 8 GB CFast® card
 16 GB CFast® card
 32 GB CFast® card
 320 GB HDD 2.5" SATA

Without drive

1x COM (RS-232)
 3x USB 2.0
 1x USB 3.0
 2x PCI
 without slots
 DVI-D, 1x DisplayPort

2x Ethernet (10/100/1000 Mbps), RJ45
 24 V DC ±20%

IP20

-20 °C ... 50 °C
 5 % ... 95 % (non-condensing)
 Bookshelf mounting
 Wall mounting
 IEC 60068-2-27
 15g, 11 ms impulse according to IEC 60068-2-27

Ordering data

Type	Order No.	Pcs. / Pkt.
VL IPC P7000	2701127	1

Ordering data

Type	Order No.	Pcs. / Pkt.
VL BPC 3000	2400183	1

Basicline box PCs

The proven box PCs in the Basicline range are powerful IPC solutions with numerous configuration options. Always optimally tailored to your requirements for on-site visualization, measurement, and control directly in the system.

Your advantages:

- High system availability thanks to a fanless design or convection booster, suitable for industrial applications, and absence of moving parts
- 3rd generation of Intel® Celeron® and Core™ i7 processors
- Large-scale compatibility with open IT standards, numerous interfaces and operating system options



Box PC for wall mounting



Computer data	
Processor	
RAM (configuration option)	
Mass storage (configuration option)	
Interfaces	
Monitor output	
Network	
Power supply unit	
General data	
Dimensions	W / H / D
Degree of protection	
Ambient temperature (operation)	
Permissible humidity (operation)	
Mounting type	
Vibration (operation)	
Shock	
EMC note	

Technical data
Intel® Celeron® 1020E 2.2 GHz
4 GB DDR3 SODIMM
8 GB DDR3 SODIMM
16 GB DDR3 SODIMM
16 GB SSD (SLC)
32 GB SSD (SLC)
1 GB CF card
2 GB CF card
4 GB CF card
8 GB CF card
16 GB CF card
32 GB CF card
1x COM (RS-232/422/485)
2x COM (RS-232)
4x USB 2.0
VGA
2x Ethernet (10/100/1000 Mbps), RJ45
24 V DC ±20%
357 mm / 190 mm / 87 mm
IP20
0 °C ... 45 °C
5 % ... 95 % (non-condensing)
Wall mounting
DIN EN 60068-2-6
15g, 11 ms according to IEC 60068-2-27
Class A product, see page 527

Description
Industrial computer - Configurable
Industrial computer - Preconfigured with 4 GB RAM, no mass storage or operating system

Ordering data		
Type	Order No.	Pcs. / Pkt.
BL BPC 3000	2400082	1
BL BPC 3001	2400080	1



High-performance box PC for wall mounting



Technical data

Intel® Core™ i7-3555LE 2.5/3.2 GHz
 4 GB DDR3 SODIMM
 8 GB DDR3 SODIMM
 16 GB DDR3 SODIMM
 16 GB SSD (SLC)
 32 GB SSD (SLC)
 1GB CF card
 2 GB CF card
 4 GB CF card
 8 GB CF card
 16 GB CF card
 32 GB CF card
 1x COM (RS-232/422/485)
 2x COM (RS-232)
 4x USB 2.0
 VGA
 2x Ethernet (10/100/1000 Mbps), RJ45
 24 V DC ±20%

357 mm / 190 mm / 87 mm
 IP20
 0 °C ... 45 °C
 5 % ... 95 % (non-condensing)
 Wall mounting
 DIN EN 60068-2-6
 15g, 11 ms according to IEC 60068-2-27
 Class A product, see page 527

Ordering data

Type	Order No.	Pcs. / Pkt.
BL BPC 7000	2400083	1
BL BPC 7001	2400081	1

Monitors with touch function

Monitors with touch function are the ideal extension to the industrial PC: operation and monitoring without mouse and keyboard. The robust LCD devices can be used directly on the machine, e.g., as a remote operating solution. Thanks to their numerous interfaces, they provide the best possible connection to your industrial PC.

Your advantages:

- Intuitive operation without mouse or keyboard, thanks to touch function
- High shock resistance and electromagnetic compatibility, thanks to robust housing suitable for industrial applications
- Large-scale compatibility, thanks to open IT standards and numerous interfaces
- Individual solutions, thanks to customer-specific hardware adaptations

Additional features:

- Monitors in various display sizes for connection to any industrial PC with VGA or DVI port
- Optional front USB interface provides additional connection options for I/O devices



30.7 cm (12.1") touch screen

Display data
Display
Monitor resolution
Display lighting type
Brightness
Display backlight MTBF
Touch screen
General data
Degree of protection
Ambient temperature (operation)
Permissible humidity (operation)
Mounting type
Vibration (operation)
Shock

Technical data	
30.7 cm/12.1" TFT	800 x 600 Pixel (SVGA)
CCFL	400 cd/m ² , typical (adjustable)
> 50,000 h	Resistive industrial touch screen
IP65 (front), IP20 (back)	0 °C ... 55 °C
5 % ... 95 %	Panel cutout or VESA mount
DIN EN 60068-2-6	15g, 11 ms according to IEC 60068-2-27

Description
Flat panel monitor with resistive touch screen
- without front USB port
Flat panel monitor with resistive touch screen
- with front USB port

Ordering data		
Type	Order No.	Pcs. / Pkt.
VL FPM 12	2913015	1
VL FPM 12U	2913016	1

Mounting kit , including hardware for installation
- panel installation
- wall mounting for 15" and 17" displays, for thicker walls
Protective foil for 15" touch screen

Accessories		
VL PANEL MOUNTING KIT	2913159	1
VL PANEL+ MOUNTING KIT	2701177	1



38.1 cm (15") touch screen



43.2 cm (17") touch screen



48 cm (19") touch screen

Technical data
38.1 cm/15" TFT
1024 x 768 Pixel (XGA)
CCFL
350 cd/m ² , typical (adjustable)
> 50,000 h
Resistive industrial touch screen
IP65 (front), IP20 (back)
0 °C ... 55 °C
5 % ... 95 %
Panel cutout or VESA mount
DIN EN 60068-2-6
15g, 11 ms according to IEC 60068-2-27

Technical data
43.2 cm/17" TFT
1280 x 1024 Pixel (SXGA)
CCFL
350 cd/m ² , typical (adjustable)
> 50,000 h
Resistive industrial touch screen
IP65 (front), IP20 (back)
0 °C ... 50 °C
5 % ... 95 %
Panel cutout or VESA mount
DIN EN 60068-2-6
15g, 11 ms according to IEC 60068-2-27

Technical data
48.3 cm/19" TFT
1280 x 1024 Pixel (SXGA)
CCFL
300 cd/m ² , typical (adjustable)
> 50,000 h
Resistive industrial touch screen
IP65 (front), IP20 (back)
0 °C ... 55 °C
5 % ... 95 %
Panel cutout or VESA mount
DIN EN 60068-2-6
15g, 11 ms according to IEC 60068-2-27

Ordering data		
Type	Order No.	Pcs. / Pkt.
VL FPM 15	2913017	1
VL FPM 15U	2913018	1

Ordering data		
Type	Order No.	Pcs. / Pkt.
VL FPM 17	2913019	1
VL FPM 17U	2913020	1

Ordering data		
Type	Order No.	Pcs. / Pkt.
VL FPM 19U	2913021	1

Accessories		
	Order No.	Pcs. / Pkt.
VL PANEL MOUNTING KIT	2913159	1
VL PANEL+ MOUNTING KIT	2701177	1
VL 15" DISPLAY PROTECTIVE FOIL	2913165	1

Accessories		
	Order No.	Pcs. / Pkt.
VL PANEL MOUNTING KIT	2913159	1
VL PANEL+ MOUNTING KIT	2701177	1

Accessories		
	Order No.	Pcs. / Pkt.
VL PANEL MOUNTING KIT	2913159	1
VL PANEL+ MOUNTING KIT	2701177	1

Embeddedline panel PCs

The Embeddedline range consists of configurable embedded panel PCs with widescreen display and appealing designs. When it comes to automating simple applications in restricted spaces, they are the ideal solution: narrow, fanless, and with comprehensive functions. Depending on your requirements, use single- or dual-core processors from the AMD G series.

Additional features:

- Front plate made from anodized aluminum
- Can be configured according to customer requirements
- Widescreen displays from 7" to 15.4"
- Standard displays from 10" to 15"
- With Windows Embedded Standard 7 as an option



17.8 cm (7") widescreen display

ERC

Technical data

Display data	Computer data
Display	Processor (configuration option)
Monitor resolution	RAM (configuration option)
Display lighting type	Mass storage (configuration option)
Brightness	
Display backlight MTBF	Optical drive (configuration option)
Touch screen	Interfaces
Computer data	Optional interfaces
Processor (configuration option)	Slots
	Monitor output
	Network
	Power supply unit
	General data
	Degree of protection
	Ambient temperature (operation)
	Permissible humidity (operation)
	Mounting type
	Vibration (operation)
	Shock
	EMC note

17.8 cm/7" TFT
800 x 480 Pixel (WVGA)
LED
350 cd/m ² , typical (adjustable)
> 40,000 h
Resistive industrial touch screen
AMD Embedded G-Series (T40R), 1.0 GHz
AMD Embedded G-Series (T40E), 2x 1.0 GHz
2 GB DDR3
Flash SSD 8 GB
Flash SSD 16 GB
Flash SSD 32 GB
Flash SSD 64 GB
Without drive
4 x USB host 2.0
1x COM (RS-232), 1x COM (RS-485)
SD card
without
2x Ethernet (10/100/1000 Mbps), RJ45
24 V DC ±20%
IP65 (front), IP20 (back)
0 °C ... 50 °C
20 % ... 85 % (non-condensing)
Installation in front plate
DIN EN 60068-2-6
DIN EN 60068-2-27
Class A product, see page 527

Ordering data

Type	Order No.	Pcs. / Pkt.
EL PPC7 1000	2701481	1

Accessories

Mounting kit, including hardware for installation		
- panel installation		
Stylus for touch screens		
Protective foil for touch screen		
HMI SCB MOUNTING KIT 4	2701384	1
TOUCH PEN	2701379	1
7" DISPLAY PROTECTIVE FOIL	2701374	1



22.9 cm (9") widescreen display



30.5 cm (12.1") widescreen display



39.05 cm (15.4") widescreen display

ERC

Technical data	
EL PPC9 1000	EL PPC10S 1000
22.9 cm/9" TFT 800 x 480 Pixel (WVGA)	26.4 cm/10.4" TFT 800 x 600 Pixel (SVGA)
LED	
400 cd/m ² , typical (adjustable) > 70000 h	350 cd/m ² , typical (adjustable) > 50,000 h
Resistive industrial touch screen	
AMD Embedded G-Series (T40R), 1.0 GHz AMD Embedded G-Series (T40E), 2x 1.0 GHz 2 GB DDR3 Flash SSD 8 GB Flash SSD 16 GB Flash SSD 32 GB Flash SSD 64 GB Without drive 4 x USB host 2.0 1x COM (RS-232), 1x COM (RS-485)	
SD card without	
2x Ethernet (10/100/1000 Mbps), RJ45 24 V DC ±20%	
IP65 (front), IP20 (back) 0 °C ... 50 °C 20 % ... 85 % (non-condensing) Installation in front plate DIN EN 60068-2-6 DIN EN 60068-2-27 Class A product, see page 527	

ERC

Technical data	
EL PPC12 1000	EL PPC12S 1000
30.73 cm/12.1" TFT 1280 x 800 Pixel (WXGA)	30.7 cm/12.1" TFT 800 x 600 Pixel (SVGA)
LED	
320 cd/m ² typical (adjustable) > 50,000 h	350 cd/m ² , typical (adjustable) > 50,000 h
Resistive industrial touch screen	
AMD Embedded G-Series (T40R), 1.0 GHz AMD Embedded G-Series (T40E), 2x 1.0 GHz 2 GB DDR3 Flash SSD 8 GB Flash SSD 16 GB Flash SSD 32 GB Flash SSD 64 GB Without drive 4 x USB host 2.0 1x COM (RS-232), 1x COM (RS-485)	
SD card without	
2x Ethernet (10/100/1000 Mbps), RJ45 24 V DC ±20%	
IP65 (front), IP20 (back) 0 °C ... 50 °C 20 % ... 85 % (non-condensing) Installation in front plate DIN EN 60068-2-6 DIN EN 60068-2-27 Class A product, see page 527	

ERC

Technical data	
EL PPC15 1000	EL PPC15S 1000
39.12 cm/15.4" TFT 1280 x 800 Pixel (WXGA)	38.1 cm/15" TFT 1024 x 768 Pixel (XGA)
LED	
360 cd/m ² typical (adjustable) > 50,000 h	320 cd/m ² typical (adjustable) > 50,000 h
Resistive industrial touch screen	
AMD Embedded G-Series (T40R), 1.0 GHz AMD Embedded G-Series (T40E), 2x 1.0 GHz 2 GB DDR3 Flash SSD 8 GB Flash SSD 16 GB Flash SSD 32 GB Flash SSD 64 GB Without drive 4 x USB host 2.0 RS-232 1x COM (RS-232), 1x COM (RS-485)	
SD card without	
2x Ethernet (10/100/1000 Mbps), RJ45 24 V DC ±20%	
IP65 (front), IP20 (back) 0 °C ... 50 °C 20 % ... 85 % (non-condensing) Installation in front plate DIN EN 60068-2-6 DIN EN 60068-2-27 Class A product, see page 527	

Ordering data		
Type	Order No.	Pcs. / Pkt.
EL PPC9 1000	2701482	1
EL PPC10S 1000	2400232	1

Ordering data		
Type	Order No.	Pcs. / Pkt.
EL PPC12 1000	2701484	1
EL PPC12S 1000	2400233	1

Ordering data		
Type	Order No.	Pcs. / Pkt.
EL PPC15 1000	2701485	1
EL PPC15S 1000	2400234	1

Accessories		
HMI SCB MOUNTING KIT 6	2701385	1
TOUCH PEN	2701379	1
9" DISPLAY PROTECTIVE FOIL	2701375	1

Accessories		
HMI SCB MOUNTING KIT 8	2701387	1
TOUCH PEN	2701379	1

Accessories		
HMI SCB MOUNTING KIT 8	2701387	1
TOUCH PEN	2701379	1

Basicline panel PCs

Panel PCs combine the advantages of a modern industrial PC with the operation and monitoring functions of a touch screen monitor. Typically installed in the front of the control cabinet, they provide monitoring and control directly on site.

Features:

- High system availability thanks to a fanless design or convection booster, suitable for industrial applications, and absence of moving parts
- 3rd generation of Intel® Celeron® and Core™ i7 processors
- Large-scale compatibility with open IT standards, numerous interfaces and operating system options
- Display sizes from 12 (SVGA) to 17 (SXGA) inches
- High graphic performance with Intel HD graphics 4000



Panel PC with Atom™ processor



Display data	Display (configuration option)
Brightness	Display backlight MTBF
Touch screen	Touch screen
Computer data	Processor (configuration option) RAM (configuration option)
Mass storage (configuration option)	
Interfaces	
Network	
Power supply unit	
General data	
Degree of protection	
Ambient temperature (operation)	
Permissible humidity (operation)	
Mounting type	
Vibration (operation)	
Shock	
EMC note	

Technical data	
30.7 cm/12.1" TFT	38.1 cm/15" TFT
43.2 cm/17" TFT	350 cd/m ² , typical (adjustable)
> 50,000 h (dependent on configuration)	Resistive industrial touch screen
Intel® Atom™ N455 1.66 GHz	2 GB DDR3 SODIMM
without mass storage	1GB CF card
	2 GB CF card
	4 GB CF card
	8 GB CF card
	16 GB CF card
	32 GB CF card
	16 GB SSD (SLC)
	32 GB SSD (SLC)
	320 GB HDD 2.5" SATA
	80 GB SSD (MLC)
	160 GB SSD (MLC)
	1x COM (RS-232/422/485)
	2x COM (RS-232)
	4x USB 2.0
	2x Ethernet (10/100/1000 Mbps), RJ45
	24 V DC ±20%
IP65 (front), IP20 (back)	0 °C ... 50 °C
5 % ... 95 % (non-condensing)	Front panel mounting
	DIN EN 60068-2-6
15g, 11 ms according to IEC 60068-2-27	Class A product, see page 527

Description
Industrial panel PC (PPC) with resistive touch screen. Configurable options for display size, memory, and mass storage.
- Atom processor - Celeron processor - Core i7 processor
Industrial panel PC (PPC) with resistive touch screen. Preconfigured with display, 2 GB RAM, no mass storage or operating system
- 30.7 cm (12.1") display - 38.1 cm (15") display - 43.2 cm (17") display
Industrial panel PC (PPC) with resistive touch screen. Preconfigured with display, 4 GB RAM, no mass storage or operating system
- 38.1 cm (15") display - 43.2 cm (17") display

Ordering data		
Type	Order No.	Pcs. / Pkt.
BL PPC 1000	2701401	1
BL PPC12 1000	2701336	1
BL PPC15 1000	2701338	1
BL PPC17 1000	2701337	1



Panel PC with Celeron® processor



Panel PC with Core™ i7 processor



Technical data

38.1 cm/15" TFT
43.2 cm/17" TFT

350 cd/m², typical (adjustable)
> 50,000 h
Resistive industrial touch screen

Intel® Celeron® 1020E 2.2 GHz
4 GB DDR3 SODIMM
8 GB DDR3 SODIMM
16 GB DDR3 SODIMM
without mass storage
1 GB CF card
2 GB CF card
4 GB CF card
8 GB CF card
16 GB CF card
32 GB CF card
16 GB SSD (SLC)
32 GB SSD (SLC)
320 GB HDD 2.5" SATA
80 GB SSD (MLC)
160 GB SSD (MLC)
1x COM (RS-232/422/485)
2x COM (RS-232)
4x USB 2.0
2x Ethernet (10/100/1000 Mbps), RJ45
24 V DC ±20%

IP65 (front), IP20 (back)
0 °C ... 45 °C
5 % ... 95 % (non-condensing)
Front panel mounting
DIN EN 60068-2-6
15g, 11 ms according to IEC 60068-2-27
Class A product, see page 527

Technical data

38.1 cm/15" TFT
43.2 cm/17" TFT

350 cd/m², typical (adjustable)
> 50,000 h
Resistive industrial touch screen

Intel® Core™ i7-3555LE 2.5/3.2 GHz
4 GB DDR3 SODIMM
8 GB DDR3 SODIMM
16 GB DDR3 SODIMM
without mass storage
1 GB CF card
2 GB CF card
4 GB CF card
8 GB CF card
16 GB CF card
32 GB CF card
16 GB SSD (SLC)
32 GB SSD (SLC)
320 GB HDD 2.5" SATA
80 GB SSD (MLC)
160 GB SSD (MLC)
1x COM (RS-232/422/485)
2x COM (RS-232)
4x USB 2.0
2x Ethernet (10/100/1000 Mbps), RJ45
24 V DC ±20%

IP65 (front), IP20 (back)
0 °C ... 45 °C
5 % ... 95 % (non-condensing)
Front panel mounting
DIN EN 60068-2-6
15g, 11 ms according to IEC 60068-2-27
Class A product, see page 527

Ordering data

Type	Order No.	Pcs. / Pkt.
BL PPC 3000	2701397	1
BL PPC15 3000	2701393	1
BL PPC17 3000	2701394	1

Ordering data

Type	Order No.	Pcs. / Pkt.
BL PPC 7000	2701398	1
BL PPC15 7000	2701395	1
BL PPC17 7000	2701396	1

Valueline panel PCs

The new generation of Valueline panel PCs combines the latest technology and robust industrial design to create a powerful operation and monitoring device. With various display sizes and numerous configuration options, the new Valueline panel PC is the tailor-made IPC solution.

Your advantages:

- Multi-touch capability with projected capacitive touch screen technology
- Extremely robust, thanks to the industrial, fanless design
- Maintenance-friendly with access to all important components
- Can be extended via PCI/PCIe slot
- High data security, thanks to 2 forms of mass storage and RAID support



Configurable panel PC with Intel® Celeron® N2930 technology

Technical data			
Display data			
Display (configuration option)	39.6 cm/15.6" TFT 47.0 cm/18.5" TFT 54.6 cm/21.5" TFT		
Monitor resolution	1366 x 768 Pixel (HD) 1920 x 1080 Pixel (Full HD)		
Display lighting type	LED		
Brightness	300 cd/m ² , typical (adjustable)		
Display backlight MTBF	> 50,000 h (dependent on configuration)		
Touch screen	Capacitive multi-touch screen		
Computer data			
Processor (configuration option)	Intel® Celeron® N2930 1.83 GHz/2.16 GHz		
RAM (configuration option)	4 GB DDR3 SODIMM 8 GB DDR3 SODIMM		
Mass storage (configuration option)	without mass storage 4 GB SSD (SLC) 8 GB SSD (SLC) 16 GB SSD (SLC) 32 GB SSD (SLC) 80 GB SSD (MLC) 160 GB SSD (MLC) 320 GB HDD 2.5" SATA		
RAID system	-		
Interfaces	1x COM (RS-232/422/485) 4x USB 2.0		
Slots	1x PCI/PCIe		
Monitor output	2x DisplayPort		
Network	2x Ethernet (10/100/1000 Mbps), RJ45		
Power supply unit	24 V DC ±20%		
General data			
Degree of protection	IP65 (front), IP40 (back)		
Ambient temperature (operation)	0 °C ... 50 °C		
Permissible humidity (operation)	5% ... 95% (non-condensing)		
Mounting type	Front panel mounting		
Vibration (operation)	DIN EN 60068-2-6		
Shock	15g, 11 ms according to IEC 60068-2-27		
Ordering data			
Description	Type	Order No.	Pcs. / Pkt.
Industrial computer	VL2 PPC 2000	2400334	1

new



Configurable panel PC with Intel® Core™ i5-4300U technology

Technical data

39.6 cm/15.6" TFT
 47.0 cm/18.5" TFT
 54.6 cm/21.5" TFT
 1366 x 768 Pixel (HD)
 1920 x 1080 Pixel (Full HD)
 LED
 300 cd/m², typical (adjustable)
 > 50,000 h (dependent on configuration)
 Capacitive multi-touch screen

Intel® Core™ i5-4300U 2.90 GHz
 4 GB DDR3 SODIMM
 8 GB DDR3 SODIMM
 16 GB DDR3 SODIMM
 without mass storage
 4 GB SSD (SLC)
 8 GB SSD (SLC)
 16 GB SSD (SLC)
 32 GB SSD (SLC)
 80 GB SSD (MLC)
 160 GB SSD (MLC)
 320 GB HDD 2.5" SATA
 0, 1
 1x COM (RS-232/422/485)
 2x USB 2.0
 2x USB 3.0
 1x PCI/PCIe
 2x DisplayPort
 2x Ethernet (10/100/1000 Mbps), RJ45
 24 V DC ±20%

IP65 (front), IP40 (back)
 0 °C ... 50 °C
 5 % ... 95 % (non-condensing)
 Front panel mounting
 DIN EN 60068-2-6
 15g, 11 ms according to IEC 60068-2-27

Ordering data

Type	Order No.	Pcs. / Pkt.
VL2 PPC 7000	2400346	1

Industrial PCs

Valueline panel PCs

Panel PCs combine the advantages of a modern industrial PC with the operation and monitoring functions of a touch monitor. They are designed for installation in the front of the control cabinet or for use at field level. This means that you benefit from high-performance PC technology directly on site.

Your advantages:

- High system availability, thanks to a fanless design which is suitable for industrial applications and the absence of moving parts
- Processor performance suited to the application: with energy-efficient Intel® Core™ i7, Intel® Core™ i3, Intel® Core™2 Duo or Intel® Atom™ processors
- Operating systems for every application, such as Windows XP, Windows 7, Windows Embedded Standard 2009 or Windows Embedded Standard 7
- Individual solutions thanks to customer-specific adaptations to hardware and software
- Particularly easy to maintain thanks to easily accessible components in the appropriately designed PC housing
- Large-scale compatibility, thanks to open IT standards and numerous interfaces
- Display diagonals from 12" to 24"
- Optional expansion slots for installation of PCI cards

Notes:
1) Configuration options can affect the operating temperature. See user manual for details.



Configurable panel PC

Display data	
Display (configuration option)	
Computer data	
Processor (configuration option)	
RAM (configuration option)	
Mass storage (configuration option)	
Optical drive (configuration option)	
Interfaces	
Slots	
Monitor output	
Network	
Power supply unit	
General data	
Degree of protection (configuration options)	
Ambient temperature (operation)	
Permissible humidity (operation)	
Mounting type (configuration option)	
Vibration (operation)	
Shock	
EMC note	

Technical data	
without display	
30.7 cm/12.1" TFT	
38.1 cm/15" TFT	
43.0 cm/ 17" TFT	
48.3 cm/19" TFT	
60.9 cm/24" TFT	
47.0 cm/18.5" TFT	
38.1 cm/15" TFT STAINLESS	
38.1 cm/15" TFT USB BK	
30.7 cm/12.1" TFT FRONT USB	
38.1 cm/15" TFT FRONT USB	
43.0 cm/17" TFT FRONT USB	
48.3 cm/19" TFT FRONT USB	
60.9 cm/24" TFT FRONT USB	
Intel® Atom™ N270 1.6 GHz	
Intel® Celeron® M ULV 423 1.01 GHz	
Intel® Core™2 Duo L7400 1.5 GHz	
Intel® Atom™ Enhanced 1.6 GHz	
512 MB DDR SODIMM	
1 GB DDR SODIMM	
2 GB DDR SODIMM	
3 GB DDR SODIMM	
without mass storage	
512 MB CF card	
1 GB CF card	
2 GB CF card	
4 GB CF card	
8 GB CF card	
16 GB CF card	
32 GB CF card	
16 GB SSD (SLC)	
32 GB SSD (SLC)	
80 GB SSD (MLC)	
160 GB SSD (MLC)	
320 GB HDD 2.5" SATA	
250 GB HDD 2.5" SATA	
DVD-RW	
Without drive	
1x COM (RS-232)	
4x USB 2.0	
2x CompactFlash®	
2x PCI	
without slots	
VGA, DVI-D (not available with Atom processors)	
2x Ethernet (10/100/1000 Mbps), RJ45	
24 V DC ±20%	
IP65 (front), IP20 (back)	
IP20	
-20 °C ... 55 °C ¹⁾	
5 % ... 95 % (non-condensing)	
Front panel mounting	
DIN EN 60068-2-6	
15g, 11 ms according to IEC 60068-2-27	

Description
Industrial computer

Ordering data		
Type	Order No.	Pcs. / Pkt.
VALUELINE IPC	2913108	1

new



Configurable panel PC with Intel® Core™ i7 technology



Configurable panel PC with Intel® Core™ i3 technology

Ex:

Technical data
without display 30.7 cm/12.1" TFT 38.1 cm/15" TFT 43.0 cm/ 17" TFT 48.3 cm/19" TFT 60.9 cm/24" TFT 47.0 cm/18.5" TFT 38.1 cm/15" TFT STAINLESS 38.1 cm/15" TFT USB BK 30.7 cm/12.1" TFT FRONT USB 38.1 cm/15" TFT FRONT USB 43.0 cm/17" TFT FRONT USB 48.3 cm/19" TFT FRONT USB 60.9 cm/24" TFT FRONT USB
Intel® Core™ i7-660UE 1.33 GHz Intel® Core™ i7-610E 2.53 GHz Intel® Core™ i7-660UE 1.33 GHz
2 GB DDR3 SODIMM 4 GB DDR3 SODIMM 8 GB DDR3 SODIMM
without mass storage 1 GB CF card 2 GB CF card 4 GB CF card 8 GB CF card 16 GB CF card 32 GB CF card 16 GB SSD (SLC) 32 GB SSD (SLC) 80 GB SSD (MLC) 160 GB SSD (MLC) 320 GB HDD 2.5" SATA
Without drive
1x COM (RS-232) 4x USB 2.0 1x CompactFlash® without slots
DVI-I
2x Ethernet (10/100/1000 Mbps), RJ45 24 V DC ±20%
IP65 (front), IP20 (back) IP20 0 °C ... 45 °C 5 % ... 95 % (non-condensing) Front panel mounting DIN EN 60068-2-6 15g, 11 ms according to IEC 60068-2-27 Class A product, see page 527

Technical data
without display 30.7 cm/12.1" TFT 38.1 cm/15" TFT 43.0 cm/ 17" TFT 48.3 cm/19" TFT 54.6 cm/21.5" TFT 47.0 cm/18.5" TFT 38.1 cm/15" TFT STAINLESS 38.1 cm/15" TFT USB BK 30.7 cm/12.1" TFT FRONT USB 38.1 cm/15" TFT FRONT USB 43.0 cm/17" TFT FRONT USB 48.3 cm/19" TFT FRONT USB 60.9 cm/24" TFT FRONT USB
Intel® Core™ i3-4010U 1.70 GHz
4 GB DDR3 SODIMM 8 GB DDR3 SODIMM 16 GB DDR3 SODIMM
without mass storage 16 GB SSD (SLC) 32 GB SSD (SLC) 80 GB SSD (MLC) 160 GB SSD (MLC) 4 GB CFast® card 8 GB CFast® card 16 GB CFast® card 32 GB CFast® card 320 GB HDD 2.5" SATA
Without drive
1x COM (RS-232) 3x USB 2.0 1x USB 3.0 2x PCI without slots DVI-D, 1x DisplayPort
2x Ethernet (10/100/1000 Mbps), RJ45 24 V DC ±20%
IP65 (front), IP20 (back) -20 °C ... 50 °C 5 % ... 95 % (non-condensing) Front panel mounting IEC 60068-2-27 15g, 11 ms impulse according to IEC 60068-2-27

Ordering data		
Type	Order No.	Pcs. / Pkt.
VL IPC P7000	2701127	1

Ordering data		
Type	Order No.	Pcs. / Pkt.
VL PPC 3000	2400184	1

Industrial PCs

IP65 panel PCs

The panel PCs in the Designline range combine high-performance technology and an attractive design. They are narrow, feature IP65 protection and multi-touch capability, and are always close to the action as they can be installed quickly and easily directly on the machine.

Thanks to their fanless and energy-efficient design, they are the ideal solution for future operating concepts in industrial systems: easy maintenance, custom configuration, and robust.

Additional features:

- Single or multi-touch screen
- Energy-efficient Intel® ATOM™ or Intel® Core™ i7 processors
- Can be configured individually
- Fully enclosed housing with IP65 protection
- Extended temperature range of -20°C to +55°C
- User-friendly handling thanks to the attractive and practical industrial design
- Easy access to all important components

Notes:
1) Configuration options can affect the operating temperature. See user manual for details.
2) Configuration options can affect the operating temperature. See data sheet for details.



Panel PC in IP65,
38.1 cm (15") display

Display data
Display
Monitor resolution
Display lighting type
Brightness
Display backlight MTBF
Touch screen
Computer data
Processor (configuration option)
RAM (configuration option)
Mass storage (configuration option)
Optical drive (configuration option)
Interfaces
Slots
Monitor output
Network
Power supply unit
General data
Degree of protection
Ambient temperature (operation)
Permissible humidity (operation)
Mounting type
Vibration (operation)
Shock
EMC note

Technical data	
DL PPC15 1000	DL PPC15M 1000
	38.1 cm/15" TFT
	1024 x 768 Pixel (XGA)
	LED
	400 cd/m ² , typical (adjustable)
	> 50,000 h
Resistive industrial touch screen	Capacitive multi-touch screen
Computer data	
	Intel® Atom™ E680T 1.6 GHz
	2 GB DDR2 800
	without mass storage
	16 GB SSD (SLC)
	32 GB SSD (SLC)
	80 GB SSD (MLC)
	160 GB SSD (MLC)
	320 GB HDD 2.5" SATA
	Without drive
	1x COM (RS-232/422/485)
	5x USB 2.0
	1x Audio
	without slots
	without
	2x Ethernet (10/100/1000 Mbps), RJ45
	24 V DC ±20%
General data	
	IP65
	-20 °C ... 55 °C ¹⁾
5 % ... 95 %	5 % ... 95 % (non-condensing)
	VESA MIS-D (100 x 100)
	1g, according to EN 60068-2-6
	15g, 11 ms according to IEC 60068-2-27
	Class A product, see page 527

Description
IPC with IP65 protection with touch screen, enclosed housing
High-performance IPC with touch screen and IP65 housing
- 38.1 cm (15") display
- 47 cm (18.5") display
- 54.6 cm (21.5") display

Ordering data		
Type	Order No.	Pcs. / Pkt.
DL PPC15 1000	2701665	1
DL PPC15M 1000	2701666	1



Fully enclosed IP65 IPC with 38.1 cm (15") display



Fully enclosed IP65 IPC with 47 cm (18.5") display



Fully enclosed IP65 IPC with 54.6 cm (21.5") display



Technical data			Technical data			Technical data		
<p>38.1 cm/15" TFT 1024 x 768 Pixel (XGA) LED 400 cd/m², typical (adjustable) > 50,000 h Capacitive multi-touch screen</p>			<p>47 cm/18.5" TFT 1366 x 768 Pixel (WXGA) LED 300 cd/m², typical (adjustable) > 50,000 h Capacitive multi-touch screen</p>			<p>54.6 cm/21.5" TFT 1920 x 1080 Pixel (Full HD) LED 300 cd/m², typical (adjustable) > 50,000 h Capacitive multi-touch screen</p>		
<p>Intel®Core™ i7-4650U 3.30 GHz 4 GB DDR3 SODIMM 8 GB DDR3 SODIMM 12 GB DDR3 SODIMM without mass storage 4 GB SSD (SLC) 8 GB SSD (SLC) 16 GB SSD (SLC) 32 GB SSD (SLC) 80 GB SSD (MLC) 160 GB SSD (MLC) 320 GB HDD 2.5" SATA Without drive 1x COM (RS-232/422/485) 4x USB 2.0 1x USB 3.0 1x Audio without slots without 2x Ethernet (10/100/1000 Mbps), RJ45 24 V DC ±20%</p>			<p>Intel®Core™ i7-4650U 3.30 GHz 4 GB DDR3 SODIMM 8 GB DDR3 SODIMM 12 GB DDR3 SODIMM without mass storage 4 GB SSD (SLC) 8 GB SSD (SLC) 16 GB SSD (SLC) 32 GB SSD (SLC) 80 GB SSD (MLC) 160 GB SSD (MLC) 320 GB HDD 2.5" SATA Without drive 1x COM (RS-232/422/485) 4x USB 2.0 1x USB 3.0 1x Audio without slots without 2x Ethernet (10/100/1000 Mbps), RJ45 24 V DC ±20%</p>			<p>Intel®Core™ i7-4650U 3.30 GHz 4 GB DDR3 SODIMM 8 GB DDR3 SODIMM 12 GB DDR3 SODIMM without mass storage 4 GB SSD (SLC) 8 GB SSD (SLC) 16 GB SSD (SLC) 32 GB SSD (SLC) 80 GB SSD (MLC) 160 GB SSD (MLC) 320 GB HDD 2.5" SATA Without drive 1x COM (RS-232/422/485) 4x USB 2.0 1x USB 3.0 1x Audio without slots without 2x Ethernet (10/100/1000 Mbps), RJ45 24 V DC ±20%</p>		
<p>IP65 -20 °C ... 45 °C²) 5 % ... 95 % (non-condensing) VESA MIS-D (100 x 100) 1g with SSD, 0.5g with HDD, according to EN 60068-2-6 15g, 11 ms according to IEC 60068-2-27 Class A product, see page 527</p>			<p>IP65 -20 °C ... 45 °C²) 5 % ... 95 % (non-condensing) VESA MIS-D (100 x 100) 1g with SSD, 0.5g with HDD, according to EN 60068-2-6 15g, 11 ms according to IEC 60068-2-27 Class A product, see page 527</p>			<p>IP65 -20 °C ... 45 °C²) 5 % ... 95 % (non-condensing) VESA MIS-D (100 x 100) 1g with SSD, 0.5g with HDD, according to EN 60068-2-6 15g, 11 ms according to IEC 60068-2-27 Class A product, see page 527</p>		
Ordering data			Ordering data			Ordering data		
Type	Order No.	Pcs. / Pkt.	Type	Order No.	Pcs. / Pkt.	Type	Order No.	Pcs. / Pkt.
DL PPC15M 7000	2400017	1	DL PPC18.5M 7000	2400015	1	DL PPC21.5M 7000	2400016	1

Industrial PCs

Panel PCs for outdoor applications

The new outdoor panel PCs fit seamlessly into the existing portfolio of panel PCs. Designed for use under extreme ambient conditions, the devices meet the requirements for an extended temperature range, easily readable displays in direct sunlight, UV resistance, and a high level of mechanical and chemical resistance.

Additional features:

- Display can be read in direct sunlight
- Resistant to UV and IR radiation
- Extended temperature range
- Watertight thanks to IP67 protection
- Resistant to environmental influences, such as salt spray and termites
- Resistant to chemicals, e.g., aggressive cleaning agents, deicers for aircraft
- Can be operated when wearing work gloves



17.8 cm (7") widescreen display

Technical data			
Display data			
Display	17.8 cm/7" TFT		
Monitor resolution	800 x 400 Pixel (WVGA)		
Display lighting type	LED		
Brightness	350 cd/m ² , typical (adjustable)		
Display backlight MTBF	> 50,000 h		
Touch screen	Resistive industrial touch screen (GFG)		
Computer data			
Processor	Intel® Atom™ E680T 1.6 GHz		
RAM	2 GB DDR2 800		
Mass storage (configuration option)	Flash SSD 8 GB Flash SSD 16 GB Flash SSD 32 GB Flash SSD 64 GB		
Interfaces	4 x USB host 2.0		
Optional interfaces	1x COM (RS-232), 1x COM (RS 485)		
Slots	SD card		
Monitor output	without		
Network	1 x Ethernet (10/100/1000 Mbps), RJ45		
Power supply unit	24 V DC ±20%		
General data			
Degree of protection (configuration options)	IP67 (front), IP20 (back) NEMA 4X		
Ambient temperature (operation)	-20 °C ... 60 °C		
Permissible humidity (operation)	20 % ... 85 % (non-condensing)		
Mounting type	Installation in front plate		
Vibration (operation)	DIN EN 60068-2-6		
Shock	DIN EN 60068-2-27		
Ordering data			
Description	Type	Order No.	Pcs. / Pkt.
Panel PC for outdoor applications	EL PPC7 1000/WT	2400065	1



30.5 cm (12.1") display



38.1 cm (15") display

Technical data

30.7 cm/12.1" TFT
 800 x 600 Pixel (SVGA)
 LED
 400 cd/m², typical (adjustable)
 > 50,000 h
 Resistive industrial touch screen (GFG)

Intel® Atom™ E680T 1.6 GHz
 2 GB DDR2 800
 Flash SSD 8 GB
 Flash SSD 16 GB
 Flash SSD 32 GB
 Flash SSD 64 GB
 4 x USB host 2.0
 1x COM (RS-232), 1x COM (RS 485)
 SD card
 without
 1 x Ethernet (10/100/1000 Mbps), RJ45
 24 V DC ±20%

IP67 (front), IP20 (back)
 NEMA 4X
 -20 °C ... 60 °C
 20 % ... 85 % (non-condensing)
 Installation in front plate
 DIN EN 60068-2-6
 DIN EN 60068-2-27

Ordering data

Type	Order No.	Pcs. / Pkt.
EL PPC12 1000/WT	2400066	1

Technical data

38.1 cm/15" TFT
 1024 x 768 Pixel (XGA)
 LED
 350 cd/m², typical (adjustable)
 > 50,000 h
 Resistive industrial touch screen (GFG)

Intel® Atom™ E680T 1.6 GHz
 2 GB DDR2 800
 Flash SSD 8 GB
 Flash SSD 16 GB
 Flash SSD 32 GB
 Flash SSD 64 GB
 4 x USB host 2.0
 1x COM (RS-232), 1x COM (RS 485)
 SD card
 without
 1 x Ethernet (10/100/1000 Mbps), RJ45
 24 V DC ±20%

IP67 (front), IP20 (back)
 NEMA 4X
 -20 °C ... 60 °C
 20 % ... 85 % (non-condensing)
 Installation in front plate
 DIN EN 60068-2-6
 DIN EN 60068-2-27

Ordering data

Type	Order No.	Pcs. / Pkt.
EL PPC15 1000/WT	2400067	1

Panel PCs for maritime applications

new

Applications in shipbuilding place special demands on operation and monitoring. In order to satisfy these requirements, Phoenix Contact has developed a new range of panel PCs.

The devices meet GL, LR, BV, DNV, ABS, and EN 60945 approval, all of which are required for the shipbuilding industry.

Additional features:

- Light-absorbing front plates
- Dimmable backlight
- Floating output and Ethernet
- Tested quality - certified according to GL, LR, BV, DNV, and ABS
- Certified compass safe distance according to DIN EN 60945
- All common communication standards supported
- Audible warning signal (horn) when operating state changes
- Narrow device version for even the most restricted spaces
- Powerful processor with realtime clock



Panel PC in IP65 (front),
17.8 cm (7") TFT color display

Technical data		
EL PPC7 1000/M	EL PPC7G 1000/M	
Display data Display 17.8 cm/7" TFT Monitor resolution 800 x 400 Pixel (WVGA) Display lighting type LED Brightness 350 cd/m ² , typical (adjustable) Display backlight MTBF > 50,000 h Touch screen Resistive industrial touch screen / Resistive industrial touch screen (GFG)		
Computer data Processor Intel® Atom™ E680T 1.6 GHz RAM 2 GB DDR2 Mass storage (configuration option) Flash SSD 8 GB Flash SSD 16 GB Flash SSD 32 GB Flash SSD 64 GB 4 x USB host 2.0 Floating output for external sensors 1x COM (RS-232), 1x COM (RS 485) SD card without 2x Ethernet (10/100/1000 Mbps), RJ45 24 V DC ±20%		
Interfaces Optional interfaces Slots Monitor output Network Power supply unit General data Degree of protection IP67 (front), IP20 (back) Ambient temperature (operation) 0 °C ... 55 °C Permissible humidity (operation) 20 % ... 85 % (non-condensing) Mounting type Installation in front plate Vibration (operation) DIN EN 60068-2-6 Shock DIN EN 60068-2-27		
Ordering data		
Type	Order No.	Pcs. / Pkt.
EL PPC7 1000/M	2400068	1
EL PPC7G 1000/M	2400282	1
Description Panel PC, for maritime applications		

new



**Panel PC in IP65 (front),
30.7 cm (12.1") TFT color display**

new



**Panel PC in IP65 (front),
38.1 cm (15") TFT color display**

Technical data

EL PPC12 1000/M EL PPC12G 1000/M

30.7 cm/12.1" TFT
800 x 600 Pixel (SVGA)
LED
400 cd/m², typical (adjustable)
> 50,000 h

Resistive industrial touch screen Resistive industrial touch screen (GFG)

Intel® Atom™ E680T 1.6 GHz
2 GB DDR2
Flash SSD 8 GB
Flash SSD 16 GB
Flash SSD 32 GB
Flash SSD 64 GB
4 x USB host 2.0
Floating output for external sensors
1x COM (RS-232), 1x COM (RS 485)
SD card
without
2x Ethernet (10/100/1000 Mbps), RJ45
24 V DC ±20%

IP67 (front), IP20 (back)
0 °C ... 55 °C
20 % ... 85 % (non-condensing)
Installation in front plate
DIN EN 60068-2-6
DIN EN 60068-2-27

Ordering data

Type	Order No.	Pcs. / Pkt.
EL PPC12 1000/M	2400069	1
EL PPC12G 1000/M	2400283	1

Technical data

EL PPC15 1000/M EL PPC15G 1000/M

38.1 cm/15" TFT
1024 x 768 Pixel (XGA)
LED
350 cd/m², typical (adjustable)
> 50,000 h

Resistive industrial touch screen Resistive industrial touch screen (GFG)

Intel® Atom™ E680T 1.6 GHz
2 GB DDR2
Flash SSD 8 GB
Flash SSD 16 GB
Flash SSD 32 GB
Flash SSD 64 GB
4 x USB host 2.0
Floating output for external sensors
1x COM (RS-232), 1x COM (RS 485)
SD card
without
2x Ethernet (10/100/1000 Mbps), RJ45
24 V DC ±20%

IP67 (front), IP20 (back)
0 °C ... 55 °C
20 % ... 85 % (non-condensing)
Installation in front plate
DIN EN 60068-2-6
DIN EN 60068-2-27

Ordering data

Type	Order No.	Pcs. / Pkt.
EL PPC15 1000/M	2400070	1
EL PPC15G 1000/M	2400284	1

Data acquisition and management, measurement, visualization or processing of large volumes of data in industrial image processing: the new powerful Rackmount PCs in standardized 19" format provide the right solution for sophisticated applications and various different tasks in your industry.

Your advantages:

- Tailored to the 19" rack format with 2 RUs or 4 RUs (Rack Units)
- Suitable for every application, thanks to scalable, powerful, and energy-efficient 4th generation Intel® processors
- Can be extended via PCI/PCIe slots
- High system availability and data security, thanks to RAID support (0/1/5/10)
- Easy maintenance, thanks to 2 or 3 hot-swappable drives
- Increased security, thanks to lockable front flap
- Easy access to air filters



Rackmount PC with 2 RUs

Computer data

Processor (configuration option)
 RAM (configuration option)
 Mass storage (configuration option)

RAID system
 Interfaces

Slots
 Extended functions

Monitor output
 Network
 Power supply unit

General data

Degree of protection
 Ambient temperature (operation)
 Permissible humidity (operation)
 Mounting type
 Vibration (operation)
 Shock

Technical data

Intel® Core™ i7-4770S 3.90 GHz
 Intel® Core™ i3-4330T 3.00 GHz
 16 GB DDR3 SODIMM
 8 GB DDR3-1066 SODIMM
 without mass storage
 1 TB HDD 2.5" SATA
 2 TB HDD 2.5" SATA
 4 TB HDD 2.5" SATA
 0, 1, 5
 1x COM (RS-232/422/485)
 1x RS-232
 4x USB 2.0
 2x USB 3.0
 optional
 3x PCI x3
 1x PCIe x8
 1x PCIe x16
 VGA, DVI-D
 2x Ethernet (10/100/1000 Mbps), RJ45
 230 V AC

IP20
 0 °C ... 55 °C
 5 % ... 95 % (non-condensing)
 Installation in the control cabinet (19")
 DIN EN 60068-2-6
 15g in all directions according to IEC 60068-2-27

Ordering data

Description	Type	Order No.	Pcs. / Pkt.
Rack mount PC - 19-inch, 2U - 19-inch, 4U	BL RACKMOUNT 2U	2400063	1

new



Rackmount PC with 4 RUs

Technical data

Intel® Core™ i7-4770S 3.90 GHz
 Intel® Core™ i3-4330T 3.00 GHz
 16 GB DDR3 SODIMM
 8 GB DDR3-1066 SODIMM
 without mass storage
 1 TB HDD 2.5" SATA
 2 TB HDD 2.5" SATA
 4 TB HDD 2.5" SATA
 0, 1, 5, 10
 1x COM (RS-232/422/485)
 1x RS-232
 6x USB 2.0
 2x USB 3.0
 optional
 8x PCI
 1x PCIe x8
 1x PCIe x16
 VGA, DVI-D
 2x Ethernet (10/100/1000 Mbps), RJ45
 230 V AC

IP20
 0 °C ... 55 °C
 5 % ... 95 % (non-condensing)
 Installation in the control cabinet (19")
 DIN EN 60068-2-6
 15g in all directions according to IEC 60068-2-27

Ordering data

Type	Order No.	Pcs. / Pkt.
BL RACKMOUNT 4U	2400064	1

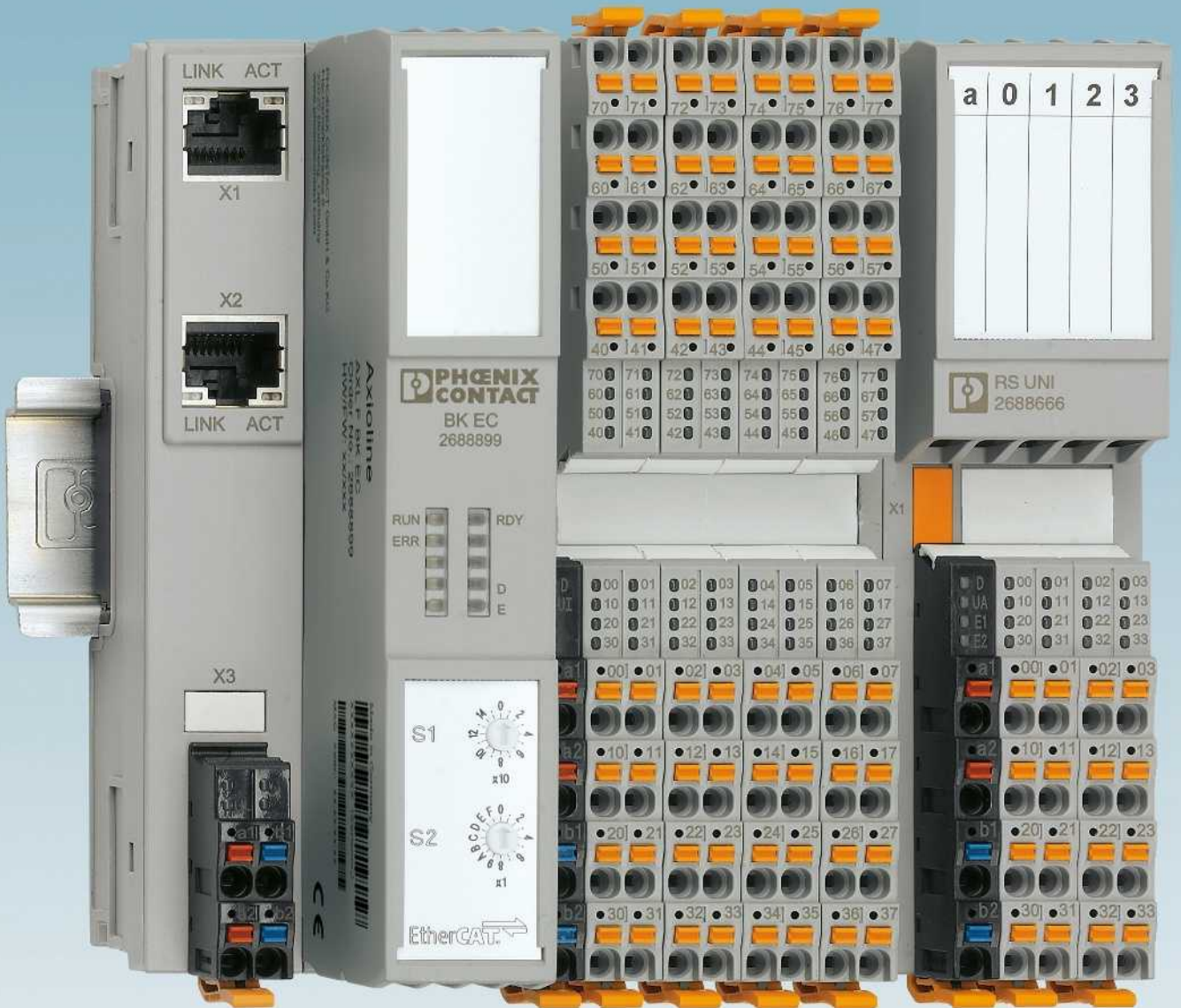

I/O systems

I/O systems from Phoenix Contact are the perfect solution for control cabinet engineering or field installation.

Axioline F

Axioline F is Phoenix Contact's I/O system for the control cabinet of the Ethernet generation.

Open to all Ethernet-based communication protocols and PROFIBUS, Axioline F enables the shortest response times, fast installation, and is characterized by its particularly robust design and easy handling.

Inline

Inline, our I/O automation kit, can be used to connect sensors and actuators with a maximum range of functions.

These I/Os can also be found in safety applications or potentially explosive areas.

INTERBUS Smart Terminals

INTERBUS Smart Terminals are perfect for connecting medium to high numbers of sensors and actuators to INTERBUS.

Axioline E

Axioline E is Phoenix Contact's I/O system for field installation of the Ethernet generation.

The I/O system features a fast response time, robust design, and easy handling.

The comprehensive portfolio with optional plastic or zinc die-cast housing enables use in a wide range of environments.

Fieldline

The devices in the Fieldline product range with IP65/IP67 protection are optimized for use in machine building and systems manufacturing directly in the field.

AS-Interface

The digital I/O devices in the Fieldline Extension AS-Interface product range offer significant installation advantages thanks to their innovative connection technology.

Ruggedline

With fiber optic technology and zinc die-cast housing with IP65/IP67 protection, the robust devices support installation in particularly harsh industrial environments.

Product overview 140

For the control cabinet (IP20)

Axioline F

Product overview 142

I/O modules 144

Inline

Product overview 166

I/O terminals 168

Inline Block IO

Product overview 222

INTERBUS Smart Terminals

Product overview 223

For field installation (IP67)

Axioline E

Product overview 224

I/O devices 226

Fieldline Modular

Product overview 240

I/O devices 242

AS-Interface

Product overview 258

I/O devices 260

Fieldline Stand-Alone

Product overview 270

Ruggedline

Product overview 271

I/O systems

Product overview

I/O systems for the control cabinet (IP20)



Axioline F

Page 142



Inline

Page 166



Inline Block IO

Page 222



INTERBUS ST

Page 223

I/O systems for field installation (IP67)



Axioline E – devices in plastic and metal versions

Page 224



Fieldline Modular

Page 240



Fieldline Stand-Alone

Page 270



AS-Interface

Page 258

Accessories



Software

Page 435



Accessories for Fieldline

Page 252



Accessories for AS-Interface

Page 267



Ruggedline

Page 271

Product overview

Bus coupler



144	145	145	145	145	147

Input and output terminals



Digital input				Digital input/output	
8 channels	16 channels	32 channels	64 channels	8 channels	16 channels
148	149	149	149	154	155
Digital output					
4 channels	8 channels	16 channels	32 channels	64 channels	
152	150	150	151	151	
Analog input		Analog output		Analog input/output	
4 channels	8 channels	4 channels	8 channels	2 channels	
156	157	158	158	159	

Open- and closed-loop control



Temperature recording			
4 channels (RTD)	8 channels (RTD)	4 channels (UTH)	8 channels (UTH)
160	161	162	162
Counters		Incremental encoder input	
2 channels		2 channels	
164		164	

Communication modules

Acquisition modules



Serial communication module	Position detection module
RS-485/422 or RS-232 input and output channel	1 SSI interface, 1 analog output
163	165

General accessories



STARTUP+

Software for starting up and diagnosing Axioline stations



AXL SHIELD SET

Axioline shield connection set



VIP-CAB-FLK14/AXIO/0,14...

Relay adapter cable



...CABLE...

Corresponding cables and connectors can be found in our online catalog

Page

451

phoenixcontact.net/products



ZB 20,3 AXL UNPRINTED

Zack marker strip (device marking) unprinted



ZBF 10/5,8 AXL UNPRINTED

Zack marker strip, flat (connector/slot marking) unprinted



EMT (35x...)R

Marking label rolls, unprinted

Page

phoenixcontact.net/products

General technical data

Ambient conditions	
Temperature range (operation)	-25°C ... +60°C
- extended (...-XC modules)	-40°C ... +70°C
Relative humidity (operation)	5% < RH < 95% (non-condensing)
Relative humidity (storage)	5% to 95% (non-condensing)
Vibration	5g according to EN 60068-2-6
Shock	25g according to EN 60068-2-27
Continuous shock	10g according to EN 60068-2-29
Degree of protection	IP20
Electromagnetic compatibility	
Noise emission	Class B according to EN 61000-6-3
Noise immunity	According to EN 61000-4
Supply voltage	
Nominal value	24 V DC
Ripple	±5% according to EN 61131-2
Permissible range	19.2 V ... 30.0 V
System times	
System bus cycle time	2 µs
Offset per module	1 µs

Dimensions		W / H / D
Type of housing:	...1H	35 mm/126.1 mm/54 mm
	...2H	35 mm/129.9 mm/54 mm
Type of housing:	...1F	53.6 mm/126.1 mm/54 mm
	...2F	53.6 mm/129.9 mm/54 mm

Bus couplers

The Axioline F bus couplers are the link between the Axioline F system and the higher-level network.

For startup tests, the Axioline F station can be started up independently of the higher-level network via either an Ethernet port or the local service interface on the bus coupler using the Startup+ software.

Features:

- Up to 63 additional Axioline F devices can be connected
- Typical cycle time of the Axioline F local bus is around 10 µs
- Runtime in bus coupler is negligible (almost 0 µs)
- Firmware can be updated
- Diagnostic and status indicators

EtherCAT® features:

- Minimum cycle time of EtherCAT® is 50 µs
- Supported mailbox protocols CoE, FoE
- Automatic and manual addressing

Modbus/TCP (UDP) features:

- Two rotary coding switches for address assignment
- Software interfaces for access via TCP/IP:
 - Device Driver Interface (DDI)
 - High-Level Language Fieldbus Interface (HFI)

PROFINET features:

- PROFINET RT
- Minimum cycle time of PROFINET for RT is 250 µs
- MRP implemented

Sercos features:

- Sercos specification V1.3
- Minimum Sercos cycle time of 31.25 µs

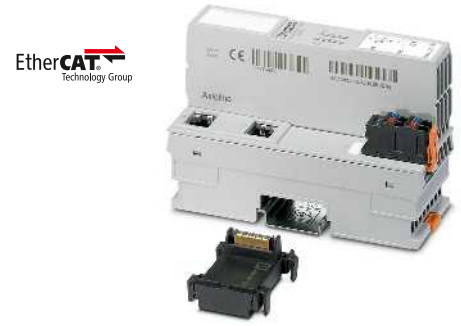
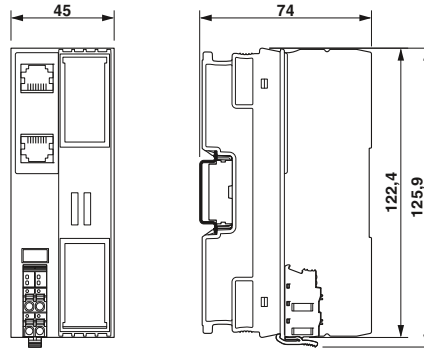

EtherCAT® bus coupler

EtherCAT Technology Group

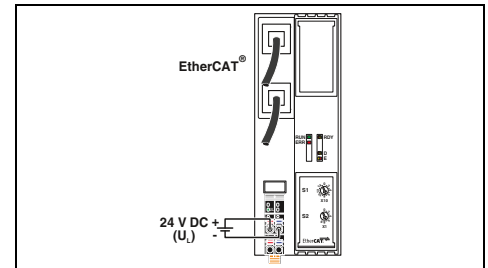

Technical data

Interface	
Fieldbus system	
Connection method	
Number	
Transmission speed	
Transmission length	
Service interface	
Connection method	
Local bus interface	
Designation	
Connection method	
Transmission speed	
Number of supported devices	
Power supply for module electronics	
Supply of communications power U_c	
Maximum permissible voltage range	
Communications power U_{Bus}	
Current supply at U_{Bus}	
Protective circuit	
General data	
Connection method	
Connection data solid / stranded / AWG	
Weight	
Dimensions	W / H / D

Remote bus	
RJ45 socket, auto negotiation and auto crossing	
2	
100 Mbps (full duplex)	
Max. 100 m	
Micro USB type B	
Axioline F local bus	
Bus base module	
100 Mbps	
Max. 63 (per station)	
24 V DC	
19.2 V DC ... 30 V DC (including all tolerances, including ripple)	
5 V DC (via bus base module)	
2 A	
Surge protection of the supply voltage	
Polarity reversal protection of the supply voltage	
Push-in technology	
0.2 ... 1.5 mm ² / 0.2 ... 1.5 mm ² / 24 - 16	
177 g	
45 mm / 125.9 mm / 74 mm	

Ordering data

Description	
Axioline bus coupler	
- For EtherCAT®	
- For Ethernet	
- For PROFINET	
- For Sercos	
- For extended temperature range of -40°C ... +70°C	

Type	Order No.	Pcs. / Pkt.
AXL F BK EC	2688899	1

Accessories

Axioline bus base module (replacement part)	
--	--

AXL BS BK	2701422	5
-----------	---------	---

Modbus/TCP (UDP)



Ethernet bus coupler

PROFINET



PROFINET bus coupler

SERCOS
the automation bus



Sercos III bus coupler

ABS BSH ClassNK

PROFIBUS

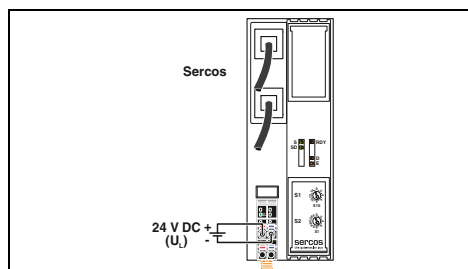
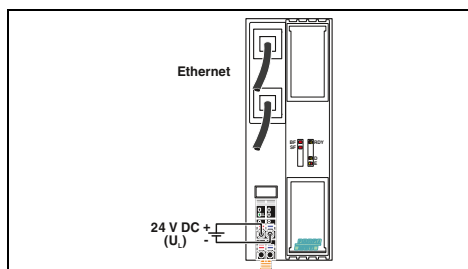
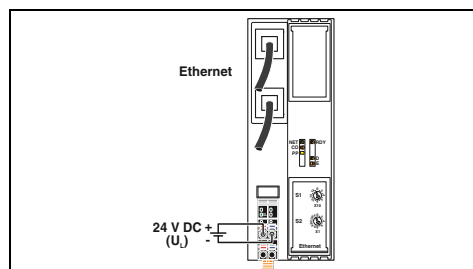

Technical data

Technical data

Technical data

Ethernet
RJ45 socket, auto negotiation and auto crossing
2
10/100 Mbps (half or full duplex mode (automatic detection, can be adjusted manually))

PROFINET
RJ45 socket, auto negotiation and auto crossing
2
100 Mbps (full duplex)

Sercos
RJ45 socket, auto negotiation and auto crossing
2
100 Mbps (full duplex)

Max. 100 m

Max. 100 m

Max. 100 m

Micro USB type B

Micro USB type B

Micro USB type B

Axioline F local bus
Bus base module
100 Mbps
Max. 63 (per station)

Axioline F local bus
Bus base module
100 Mbps
Max. 63 (per station)

Axioline F local bus
Bus base module
100 Mbps
Max. 63 (per station)

24 V DC
19.2 V DC ... 30 V DC (including all tolerances, including ripple)

24 V DC
19.2 V DC ... 30 V DC (including all tolerances, including ripple)

24 V DC
19.2 V DC ... 30 V DC (including all tolerances, including ripple)

5 V DC (via bus base module)
2 A
Surge protection of the supply voltage
Polarity reversal protection of the supply voltage

5 V DC (via bus base module)
2 A
Surge protection of the supply voltage
Polarity reversal protection of the supply voltage

5 V DC (via bus base module)
2 A
Surge protection of the supply voltage
Polarity reversal protection of the supply voltage

Push-in technology
0.2 ... 1.5 mm² / 0.2 ... 1.5 mm² / 24 - 16
177 g
45 mm / 125.9 mm / 74 mm

Push-in technology
0.2 ... 1.5 mm² / 0.2 ... 1.5 mm² / 24 - 16
177 g
45 mm / 125.9 mm / 74 mm

Push-in technology
0.2 ... 1.5 mm² / 0.2 ... 1.5 mm² / 24 - 16
177 g
45 mm / 125.9 mm / 74 mm

Ordering data

Ordering data

Ordering data

Type	Order No.	Pcs. / Pkt.
AXL F BK ETH	2688459	1
AXL F BK ETH XC	2701949	1

Type	Order No.	Pcs. / Pkt.
AXL F BK PN	2701815	1

Type	Order No.	Pcs. / Pkt.
AXL F BK S3	2701686	1

Accessories

Accessories

Accessories

AXL BS BK	2701422	5
-----------	---------	---

AXL BS BK	2701422	5
-----------	---------	---

AXL BS BK	2701422	5
-----------	---------	---

Bus couplers

The Axioline F bus couplers are the link between the Axioline F system and the higher-level network.

For startup tests, the Axioline F station can be started up independently of the higher-level network via either an Ethernet port or the local service interface on the bus coupler using the Startup+ software.

Features:

- 2 RJ45 connections (with integrated switch)
- Up to 63 additional Axioline F devices can be connected
- Typical cycle time of the Axioline F local bus is around 10 μ s
- Runtime in bus coupler is negligible (almost 0 μ s)
- Firmware can be updated
- Diagnostic and status indicators

EtherNet/IP™ features:

- ACD (Address Conflict Detection) implemented
- RPI (Request Packet Interval) of 5 μ s

SAS features (IEC 61850):

- Communication according to IEC 61850-5, MMS, and GOOSE
- Time synchronization via SNTP
- Web server

PROFIBUS features:

- I&M functions
- Operation of PROFIsafe devices

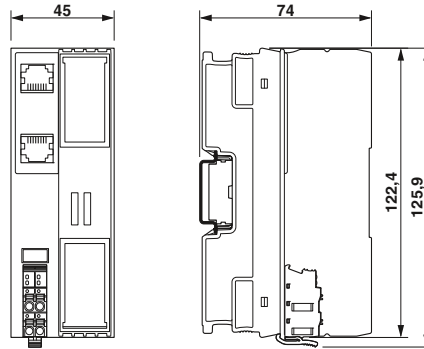

EtherNet/IP



new

EtherNet/IP™ bus coupler

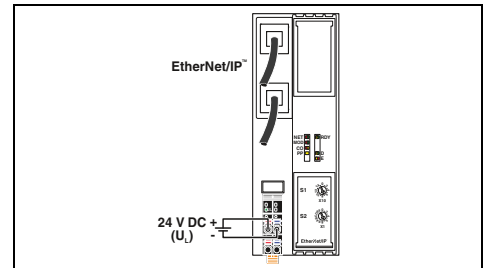

Technical data

Interface	
Fieldbus system	EtherNet/IP™
Connection method	RJ45 socket, auto negotiation and auto crossing
Number	2
Transmission speed	10/100 Mbps (half or full duplex mode (automatic detection, can be adjusted manually))
Transmission length	
Service interface	Max. 100 m
Local bus interface	
Designation	Axioline F local bus
Connection method	Bus base module
Transmission speed	100 Mbps
Number of supported devices	Max. 63 (per station)
Power supply for module electronics	
Supply of communications power U_L	24 V DC
Maximum permissible voltage range	19.2 V DC ... 30 V DC (including all tolerances, including ripple)
Communications power U_{Bus}	
Current supply at U_{Bus}	5 V DC (via bus base module)
Protective circuit	2 A
General data	
Connection method	Push-in technology
Connection data solid / stranded / AWG	0.2 ... 1.5 mm ² / 0.2 ... 1.5 mm ² / 24 - 16
Weight	177 g
Dimensions	45 mm / 125.9 mm / 74 mm

Technical data		
EtherNet/IP™		
RJ45 socket, auto negotiation and auto crossing		
2		
10/100 Mbps (half or full duplex mode (automatic detection, can be adjusted manually))		
Max. 100 m		
Micro USB type B		
Axioline F local bus		
Bus base module		
100 Mbps		
Max. 63 (per station)		
24 V DC		
19.2 V DC ... 30 V DC (including all tolerances, including ripple)		
5 V DC (via bus base module)		
2 A		
Surge protection of the supply voltage		
Polarity reversal protection of the supply voltage		
Push-in technology		
0.2 ... 1.5 mm ² / 0.2 ... 1.5 mm ² / 24 - 16		
177 g		
45 mm / 125.9 mm / 74 mm		

Description	
Axioline bus coupler	
- For EtherNet/IP™	
- For Ethernet (IEC 61850)	
- For PROFIBUS	

Ordering data		
Type	Order No.	Pcs. / Pkt.
AXL F BK EIP	2688394	1

Axioline bus base module (replacement part)	
--	--

Accessories		
AXL BS BK	2701422	5

new

Ethernet



Ethernet bus coupler (IEC 61850)



PROFIBUS bus coupler

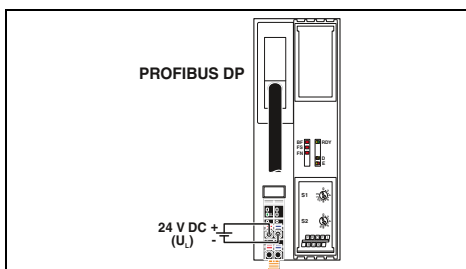
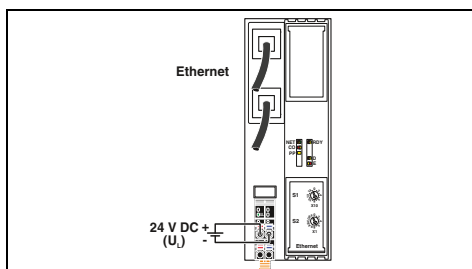

Technical data

Technical data

Ethernet
RJ45 socket, auto negotiation and auto crossing
2
100 Mbps (full duplex)

PROFIBUS DP
9-pos. D-SUB (socket)
1
9.6 kbps ... 12 Mbps

Max. 100 m

-

Micro USB type B

Micro USB type B

Axioline F local bus
Bus base module
100 Mbps
Max. 63 (per station)

Axioline F local bus
Bus base module
100 Mbps
Max. 63 (per station)

24 V DC
19.2 V DC ... 30 V DC (including all tolerances, including ripple)

24 V DC
19.2 V DC ... 30 V DC (including all tolerances, including ripple)

5 V DC (via bus base module)
2 A
Surge protection of the supply voltage
Polarity reversal protection of the supply voltage

5 V DC (via bus base module)
2 A
Surge protection of the supply voltage
Polarity reversal protection of the supply voltage

Push-in technology
0.2 ... 1.5 mm² / 0.2 ... 1.5 mm² / 24 - 16
177 g
45 mm / 125.9 mm / 74 mm

Push-in technology
0.2 ... 1.5 mm² / 0.2 ... 1.5 mm² / 24 - 16
175 g
45 mm / 125.9 mm / 74 mm

Ordering data

Ordering data

Type	Order No.	Pcs. / Pkt.
AXL F BK SAS	2701457	1

Type	Order No.	Pcs. / Pkt.
AXL F BK PB	2688530	1

Accessories

Accessories

AXL BS BK	2701422	5
-----------	---------	---

AXL BS BK	2701422	5
-----------	---------	---

Digital input modules

These modules are designed for use within an Axioline F station.

The digital input modules are used to connect 24 V DC sensors. Sensors with up to four wires can be connected.

Features:

- Minimum update time of < 100 µs
- Adjustable filter times
- Maximum input frequency: 5 kHz
- Stored device rating plate
- Diagnostic and status indicators

AXL DI 8/2 110/220DC 1F features:

- Impulse withstand voltage: 5 kV
- Developed according to the requirements of IEC 61850-3

AXL DI 16/1 HS 1H features:

- Minimum update time of 5 µs

new



8 inputs, wide range



16 inputs

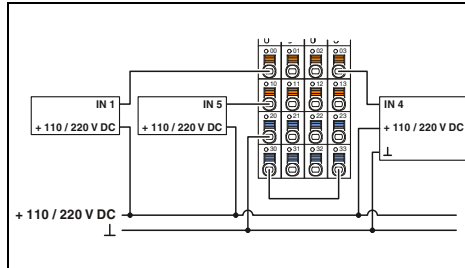

Technical data

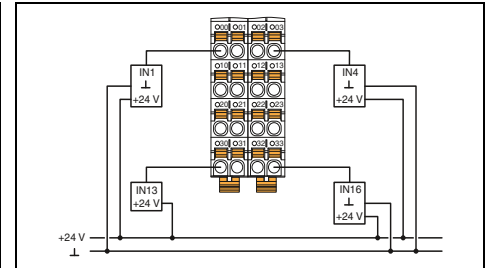

Technical data

Local bus interface	
Designation	Axioline F local bus
Connection method	Bus base module
Power supply for module electronics	
Communications power U_{Bus}	5 V DC (via bus base module)
Current consumption from U_{Bus}	Max. 120 mA
I/O supply	
Supply of digital input modules U_i	-
Supply voltage range U_i	-
Current consumption from U_i	-
Protective circuit	-
Digital inputs	
Connection technology	2-wire
Number of inputs	8
Description of the inputs	EN 61131-2 type 1
Nominal input voltage U_{IN}	110 V DC 220 V DC
Nominal input current at U_{IN}	1.5 mA
Input filter time	< 1 ms
Protective circuit	Polarity reversal protection of the inputs
General data	
Connection method	Push-in technology
Connection data solid / stranded / AWG	0.2 ... 1.5 mm ² / 0.2 ... 1.5 mm ² / 24 - 16
Weight	173 g
Dimensions	53.6 mm / 126.1 mm / 54 mm

AXL F DI16/1 1H	AXL F DI16/1 HS 1H	
	Axioline F local bus Bus base module	
	5 V DC (via bus base module) Max. 120 mA	
	24 V DC 19.2 V DC ... 30 V DC (including all tolerances, including ripple)	
	20 mA Surge protection of the supply voltage Polarity reversal protection of the supply voltage	
	1-wire 16 EN 61131-2 types 1 and 3 24 V DC	
	2.4 mA 3000 µs (default) 1000 µs < 100 µs	2.3 mA < 5 µs
	Polarity reversal protection of the inputs	
	Push-in technology	
	0.2 ... 1.5 mm ² / 0.2 ... 1.5 mm ² / 24 - 16	
	173 g	
	35 mm / 126.1 mm / 54 mm	

Ordering data

Description	
Axioline digital input module , complete with accessories (bus base module)	
- 8 inputs	
- 16 inputs	
- 16 inputs	
- 32 inputs	
- 64 inputs	
- for extended temperature range of -40°C ... +70°C	

Type	Order No.	Pcs. / Pkt.
AXL F DI8/2 110/220DC 1F	2700684	1

Ordering data

Type	Order No.	Pcs. / Pkt.
AXL F DI16/1 1H AXL F DI16/1 HS 1H	2688310 2701722	1 1

Accessories

Axioline bus base module (replacement part)	
--	--

AXL F BS F	2688129	5
------------	---------	---

Accessories

AXL F BS H	2700992	5
------------	---------	---



16 inputs



32 inputs



64 inputs

ABS BSH **ClassNK**

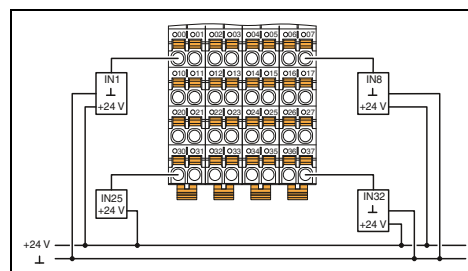
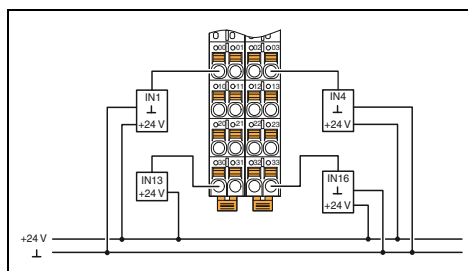
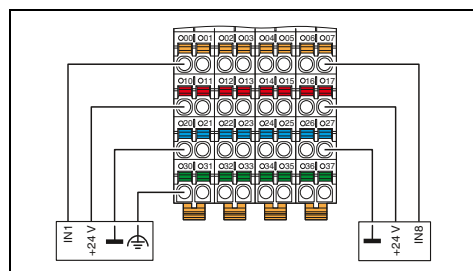

Technical data

Technical data

Technical data

Axioline F local bus
Bus base module

5 V DC (via bus base module)
Max. 120 mA

24 V DC
19.2 V DC ... 30 V DC (including all tolerances, including ripple)

Max. 4 A (2 A for each group of 8 inputs)
Surge protection of the supply voltage
Polarity reversal protection of the supply voltage

2, 3, 4-wire
16
EN 61131-2 types 1 and 3
24 V DC

2.4 mA
500 µs (default)
< 100 µs

Polarity reversal protection of the inputs

Push-in technology
0.2 ... 1.5 mm² / 0.2 ... 1.5 mm² / 24 - 16
231 g
53.6 mm / 129.9 mm / 54 mm

Axioline F local bus
Bus base module

5 V DC (via bus base module)
Max. 120 mA

24 V DC
19.2 V DC ... 30 V DC (including all tolerances, including ripple)

Max. 50 mA
Surge protection of the supply voltage
Polarity reversal protection of the supply voltage

1-wire
32
EN 61131-2 types 1 and 3
24 V DC

2.4 mA
3000 µs (default)
1000 µs
< 100 µs

Polarity reversal protection of the inputs

Push-in technology
0.2 ... 1.5 mm² / 0.2 ... 1.5 mm² / 24 - 16
159 g
35 mm / 129.9 mm / 54 mm

Axioline F local bus
Bus base module

5 V DC (via bus base module)
Max. 120 mA

24 V DC
19.2 V DC ... 30 V DC (including all tolerances, including ripple)

Max. 60 mA
Surge protection of the supply voltage
Polarity reversal protection of the supply voltage

1-wire
64
EN 61131-2 types 1 and 3
24 V DC

2.4 mA
3000 µs (default)
1000 µs
< 100 µs

Polarity reversal protection of the inputs

Push-in technology
0.2 ... 1.5 mm² / 0.2 ... 1.5 mm² / 24 - 16
231 g
53.6 mm / 129.9 mm / 54 mm

Ordering data

Ordering data

Ordering data

Type	Order No.	Pcs. / Pkt.
AXL F DI16/4 2F	2688022	1
AXL F DI16/4 XC 2F	2701224	1

Type	Order No.	Pcs. / Pkt.
AXL F DI32/1 2H	2702052	1
AXL F DI32/1 XC 1F	2701226	1

Type	Order No.	Pcs. / Pkt.
AXL DI 64/1	2701450	1

Accessories

Accessories

Accessories

AXL F BS F	2688129	5
------------	---------	---

AXL F BS F	2688129	5
------------	---------	---

AXL F BS F	2688129	5
------------	---------	---

Digital output modules

These modules are designed for use within an Axioline F station.

The digital output modules are used to output digital 24 V DC signals. Actuators with up to 3 wires can be connected.

Features:

- Short-circuit-proof outputs
- Diagnostic and status indicators
- Output behavior can be adjusted for when local bus communication is aborted



8 outputs, 2 A /
16 outputs



16 outputs,
FLK20 connection for system cabling

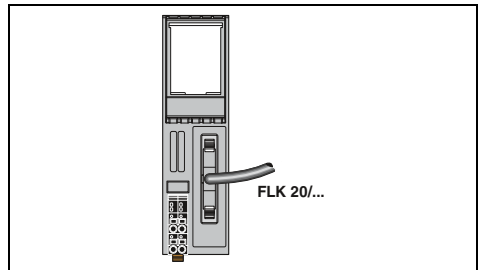
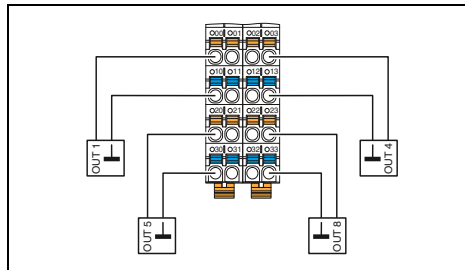

Technical data

AXL DO 8/2-2A AXL F DO16/1 1H

Axioline F local bus
Bus base module

5 V DC (via bus base module)
Max. 150 mA Max. 120 mA

24 V DC
19.2 V DC ... 30 V DC (including all tolerances, including ripple)

Max. 16 A (provide external protection; if the total current of 8 A is exceeded, connect the supply at the power connector in parallel via both terminal points) 8 A (external fuse)

Surge protection of the supply voltage
Polarity reversal protection of the supply voltage

2-wire 1-wire
8 16

24 V 500 mA
2 A 8 A (external fuse)
16 A (external fuse) 8 A (external fuse)

Shutdown with automatic restart
Short-circuit protection, overload protection of the outputs

General data

Push-in technology

0.5 ... 1.5 mm² / 0.2 ... 1.5 mm² /
0.5 ... 1.5 mm² / 20 - 16 0.2 ... 1.5 mm² / 24 - 16

136 g 134 g
35 mm / 126.1 mm / 54 mm

Ordering data

Type	Order No.	Pcs. / Pkt.
AXL DO 8/2-2A	2688381	1
AXL F DO16/1 1H	2688349	1

Accessories

AXL F BS H	2700992	5
------------	---------	---

Technical data

Axioline F local bus
Bus base module

5 V DC (via bus base module)
Max. 120 mA

24 V DC
19.2 V DC ... 30 V DC (including all tolerances, including ripple)

8 A (external fuse)

Surge protection of the supply voltage
Polarity reversal protection of the supply voltage

FLK connector (20-pos.)
16

24 V 500 mA
8 A (external fuse)

Shutdown with automatic restart
Short-circuit protection, overload protection of the outputs

General data

Push-in technology

0.2 ... 1.5 mm² / 0.2 ... 1.5 mm² / 24 - 16

108 g
35 mm / 126.1 mm / 54 mm

Class A product, see page 527

Ordering data

Type	Order No.	Pcs. / Pkt.
AXL F DO16 FLK 1H	2701813	1

Accessories

AXL F BS H	2700992	5
------------	---------	---

Local bus interface	
Designation	
Connection method	
Power supply for module electronics	
Communications power U_{Bus}	
Current consumption from U_{Bus}	
I/O supply	
Supply of digital output modules U_O	
Supply voltage range U_O	
Current consumption from U_O	
Protective circuit	
Digital outputs	
Connection technology	
Number of outputs	
Output voltage	
Maximum output current per channel	
Maximum output current per module	
Behavior in the event of overload	
Protective circuit	
General data	
Connection method	
Connection data solid / stranded / AWG	
Weight	
Dimensions	W / H / D
EMC note	

Description	
Axioline digital output module , complete with accessories (bus base module)	
- 8 outputs	
- 16 outputs	
- 32 outputs	
- 64 outputs	
- for extended temperature range of -40°C ... +70°C	

Axioline bus base module (replacement part)	
---	--

new



16 outputs



32 outputs



64 outputs

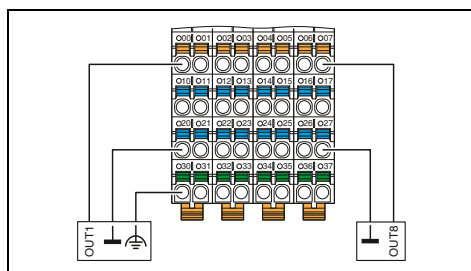

Technical data

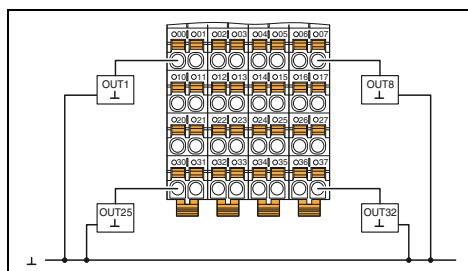

Technical data

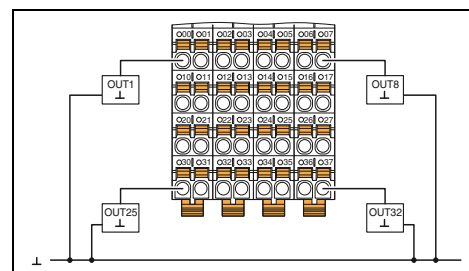

Technical data

Axioline F local bus Bus base module
5 V DC (via bus base module) Max. 120 mA
24 V DC 19.2 V DC ... 30 V DC (including all tolerances, including ripple)
Max. 8 A (external fuse)
Surge protection of the supply voltage Polarity reversal protection of the supply voltage
2, 3-wire 16 24 V 500 mA 8 A (external fuse) Shutdown with automatic restart Short-circuit protection, overload protection of the outputs
Push-in technology 0.2 ... 1.5 mm ² / 0.2 ... 1.5 mm ² / 24 - 16
234 g 53.6 mm / 129.9 mm / 54 mm

Axioline F local bus Bus base module
5 V DC (via bus base module) Max. 180 mA
24 V DC 19.2 V DC ... 30 V DC (including all tolerances, including ripple)
Max. 8 A (external fuse)
Surge protection of the supply voltage Polarity reversal protection of the supply voltage
1-wire 32 24 V 500 mA 8 A (external fuse) Shutdown with automatic restart Short-circuit protection, overload protection of the outputs
Push-in technology 0.2 ... 1.5 mm ² / 0.2 ... 1.5 mm ² / 24 - 16
191 g 53.6 mm / 126.1 mm / 54 mm

Axioline F local bus Bus base module
5 V DC (via bus base module) Max. 120 mA
24 V DC 19.2 V DC ... 30 V DC (including all tolerances, including ripple)
Max. 16 A (for parallel supply, provide external protection)
Surge protection of the supply voltage Polarity reversal protection of the supply voltage
1-wire 64 500 mA 16 A (external fuse) Shutdown with automatic restart Short-circuit protection, overload protection of the outputs
Push-in technology 0.2 ... 1.5 mm ² / 0.2 ... 1.5 mm ² / 24 - 16
260 g 53.6 mm / 129.9 mm / 54 mm

Ordering data		
Type	Order No.	Pcs. / Pkt.
AXL F DO16/3 2F	2688048	1
AXL F DO16/3 XC 2F	2701228	1

Ordering data		
Type	Order No.	Pcs. / Pkt.
AXL DO 32/1	2688051	1
AXL F DO32/1 XC 1F	2701230	1

Ordering data		
Type	Order No.	Pcs. / Pkt.
AXL F DO64/1 2F	2702053	1

Accessories		
AXL F BS F	2688129	5

Accessories		
AXL F BS F	2688129	5

Accessories		
AXL F BS F	2688129	5

Digital output modules

This module is designed for use within an Axioline F station.

The digital output module is used to output digital signals in the wide voltage range between 12 V AC and 253 V AC. Connection is via 2- or 3-wire technology.

Features:

- Nominal voltage up to 230 V AC
- Undervoltage monitoring
- Diagnostic and status indicators
- Output behavior can be adjusted for when local bus communication is aborted

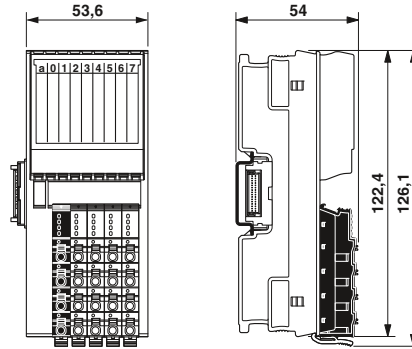

new

4 outputs,
12 ... 253 V AC wide range

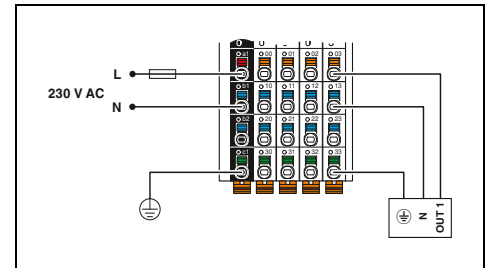

Technical data

Local bus interface	Axioline F local bus
Designation	Bus base module
Connection method	
Power supply for module electronics	
Communications power U_{Bus}	5 V DC (via bus base module)
Current consumption from U_{Bus}	Max. 120 mA
I/O supply	
Supply of digital output modules U_O	230 V AC
Supply voltage range U_O	12 V AC ... 253 V AC (including all tolerances, including ripple, 50 ... 60 Hz)
Current consumption from U_O	Max. 8 A (external fuse)
Protective circuit	Surge protection of the supply voltage
Digital outputs	
Connection technology	2, 3-wire
Number of outputs	4 (Triac outputs with zero voltage switch)
Output voltage	230 V AC
Maximum output current per channel	2 A AC
Maximum output current per module	8 A AC (external fuse)
Behavior in the event of overload	Output may be damaged
Protective circuit	External protection required
General data	
Connection method	Push-in technology
Connection data solid / stranded / AWG	0.5 ... 1.5 mm ² / 0.5 ... 1.5 mm ² / 20 - 16
Weight	188 g

Ordering data

Description	Type	Order No.	Pcs. / Pkt.
Axioline digital output module, complete with accessories (bus base module)	AXL F D04/3 AC 1F	2702068	1

Accessories

Axioline bus base module (replacement part)	AXL F BS F	2688129	5
---	------------	---------	---

new

Digital output modules

This module is designed for use within an Axioline F station.

The digital output module is used to output digital signals via relays with floating N/O contacts. Connection is via 2-wire technology.

Features:

- Impulse withstand voltage: 5 kV
- Developed according to the requirements of IEC 61850-3
- Nominal voltage up to 220 V DC or 230 V AC
- Diagnostic and status indicators
- Output behavior can be adjusted for when local bus communication is aborted

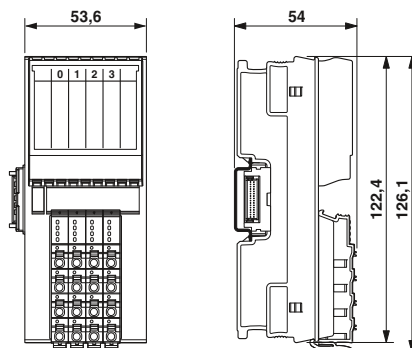

4 relay outputs

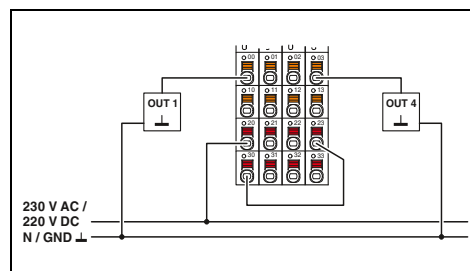

Local bus interface	
Designation	Axioline F local bus
Connection method	Bus base module
Power supply for module electronics	
Communications power U_{Bus}	5 V DC (via bus base module)
Current consumption from U_{Bus}	Max. 280 mA (all relays pick up)
Relay contact data	
Contact type	4 floating N/O contacts
Switching voltage	Max. 300 V DC
Switching current	Max. 8 A AC (cos phi = 1)
Switching capacity	Max. 2000 VA
Switching rate	Max. 6 (per minute)
Release time	< 5 ms
General data	
Connection method	Push-in technology
Connection data solid / stranded / AWG	0.2 ... 1.5 mm ² / 0.2 ... 1.5 mm ² / 24 - 16
Weight	206 g

Technical data

Technical data		
Axioline F local bus		
Bus base module		
5 V DC (via bus base module)		
Max. 280 mA (all relays pick up)		
4 floating N/O contacts		
Max. 300 V DC		
Max. 8 A AC (cos phi = 1)		
Max. 2000 VA		
Max. 6 (per minute)		
< 5 ms		
Push-in technology		
0.2 ... 1.5 mm ² / 0.2 ... 1.5 mm ² / 24 - 16		
206 g		

Description	Axioline digital output module, complete with accessories (bus base module)
-------------	---

Ordering data

Type	Order No.	Pcs. / Pkt.
AXL F DOR4/2 AC/220DC 1F	2700608	1

Description	Axioline bus base module (replacement part)
-------------	---

Accessories

Type	Order No.	Pcs. / Pkt.
AXL F BS F	2688129	5

Digital input and output modules

These modules are designed for use within an Axioline F station.

They are used to acquire and output digital 24 V DC signals.

You can adjust the filter times of the inputs to increase noise immunity.

Features:

- Connection of sensors or actuators in 1-, 2- or 3-wire technology
- Minimum update time of < 100 μ s
- Adjustable filter times
- Maximum input frequency: 5 kHz
- Short-circuit-proof outputs
- Diagnostic and status indicators
- Stored device rating plate

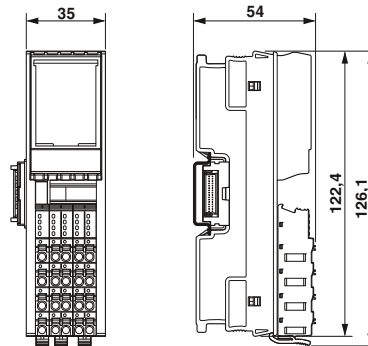

8 inputs and 8 outputs

BSH **ClassNK**

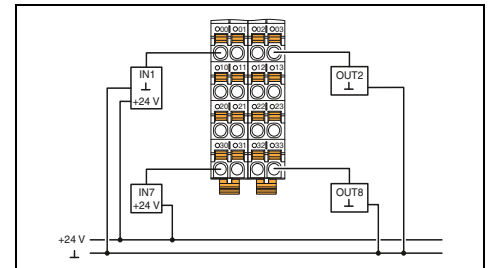

Technical data

Local bus interface	Axioline F local bus
Designation	Bus base module
Connection method	
Power supply for module electronics	5 V DC (via bus base module)
Communications power U_{Bus}	Max. 120 mA
Current consumption from U_{Bus}	
I/O supply	24 V DC
Digital input and output module supply U_{IO}	19.2 V DC ... 30 V DC (including all tolerances, including ripple)
Supply voltage range U_{IO}	
Protective circuit	Surge protection of the supply voltage Polarity reversal protection of the supply voltage
Digital inputs	1-wire
Connection technology	8
Number of inputs	EN 61131-2 types 1 and 3
Description of the inputs	24 V DC
Nominal input voltage U_{IN}	2.4 mA
Nominal input current at U_{IN}	3000 μ s (default)
Input filter time	1000 μ s
	< 100 μ s
Protective circuit	Polarity reversal protection of the inputs
Digital outputs	1-wire
Connection technology	8
Number of outputs	24 V DC
Output voltage	500 mA
Maximum output current per channel	4 A (external fuse)
Maximum output current per module	Shutdown with automatic restart
Behavior in the event of overload	Short-circuit protection, overload protection of the outputs
Protective circuit	
General data	
Connection method	Push-in technology
Connection data solid / stranded / AWG	0.2 ... 1.5 mm ² / 0.2 ... 1.5 mm ² / 24 - 16
Weight	133 g
Dimensions	35 mm / 126.1 mm / 54 mm
EMC note	Class A product, see page 527

Ordering data

Type	Order No.	Pcs. / Pkt.
AXL F DI8/1 DO8/1 1H	2701916	1
AXL F DI8/1 DO8/1 XC 1H	2702017	1

Accessories

AXL F BS H	2700992	5
------------	---------	---

Description
Axioline digital input/output module , complete with accessories (bus base module)
- 8 inputs, 8 outputs
- 16 inputs, 16 outputs
- for extended temperature range of -40°C ... +70°C

Axioline bus base module (replacement part)

new



8 inputs and 8 outputs

new



16 inputs and 16 outputs

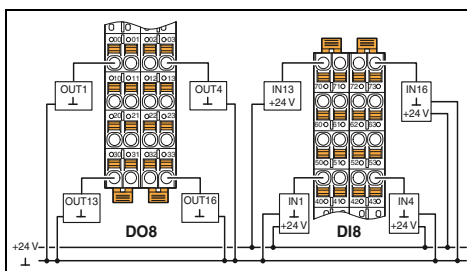
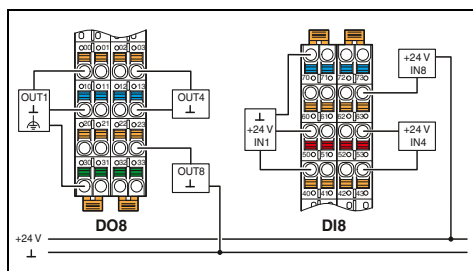

Technical data

Axioline F local bus
 Bus base module

5 V DC (via bus base module)
 Max. 120 mA

24 V DC

19.2 V DC ... 30 V DC (including all tolerances, including ripple)

Surge protection of the supply voltage
 Polarity reversal protection of the supply voltage

2, 3-wire
 8
 EN 61131-2 types 1 and 3
 24 V DC
 2.4 mA
 3000 µs (default)
 1000 µs
 < 100 µs
 Polarity reversal protection of the inputs

2, 3-wire
 8
 24 V DC
 500 mA
 8 A (external fuse)
 Shutdown with automatic restart
 Short-circuit protection, overload protection of the outputs

Push-in technology
 0.2 ... 1.5 mm² / 0.2 ... 1.5 mm² / 24 - 16
 159 g
 35 mm / 129.9 mm / 54 mm

Technical data

Axioline F local bus
 Bus base module

5 V DC (via bus base module)
 Max. 120 mA

24 V DC

19.2 V DC ... 30 V DC (including all tolerances, including ripple)

Surge protection of the supply voltage
 Polarity reversal protection of the supply voltage

1-wire
 16
 EN 61131-2 types 1 and 3
 24 V DC
 2.4 mA
 3000 µs (default)
 1000 µs
 < 100 µs
 Polarity reversal protection of the inputs

1-wire
 16
 24 V DC
 500 mA
 8 A (external fuse)
 Shutdown with automatic restart
 Short-circuit protection, overload protection of the outputs

Push-in technology
 0.2 ... 1.5 mm² / 0.2 ... 1.5 mm² / 24 - 16
 159 g
 35 mm / 129.9 mm / 54 mm

Ordering data

Type	Order No.	Pcs. / Pkt.
AXL F DI8/3 DO8/3 2H	2702071	1

Ordering data

Type	Order No.	Pcs. / Pkt.
AXL F DI16/1 DO16/1 2H	2702106	1

Accessories

AXL F BS H	2700992	5
------------	---------	---

Accessories

AXL F BS H	2700992	5
------------	---------	---

Analog input modules

These modules are designed for use within an Axioline F station.

They are used to acquire standard analog current and voltage signals. Connection is via 2-, 3- or 4-wire technology and a shield connection.

Features:

- Up to 8 analog differential signal inputs
- Current and voltage measuring ranges
- Input filter selection
- Minimum update time of 250 μ s
- 16-bit measured value representation
- Stored device rating plate
- Integrated sensor supply

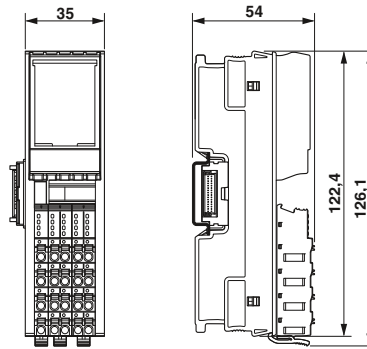

4 inputs
Current signals

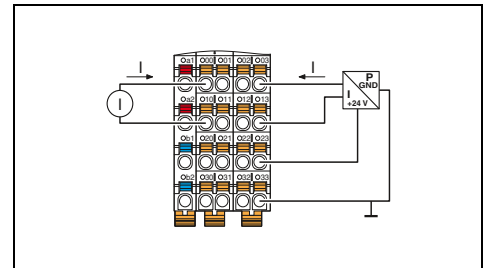

Local bus interface	
Designation	Axioline F local bus
Connection method	Bus base module
Power supply for module electronics	
Communications power U_{Bus}	5 V DC (via bus base module)
Current consumption from U_{Bus}	Max. 150 mA
I/O supply	
Supply of analog modules U_A	24 V DC
Protective circuit	Surge protection Protection against polarity reversal Transient protection
Analog inputs	
Connection technology	2, 3, 4-wire (shielded)
Number of inputs	Max. 4 (differential inputs, current)
Voltage input signal	-
Current input signal	0 mA ... 20 mA / 4 mA ... 20 mA / -20 mA ... 20 mA
Characteristics	
Measured value representation	16 bits (15 bits + sign bit)
Input filter	30 Hz, 12 kHz and mean-value generation (can be parameterized)
Accuracy	0.1 % (of measuring range final value for active mean-value generation and 30 Hz filter)
General data	
Connection method	Push-in technology
Connection data solid / stranded / AWG	0.2 ... 1.5 mm ² / 0.2 ... 1.5 mm ² / 24 - 16
Weight	145 g
Dimensions	35 mm / 126.1 mm / 54 mm

Technical data

Local bus interface		
Axioline F local bus		
Bus base module		
Power supply for module electronics		
5 V DC (via bus base module)		
Max. 150 mA		
I/O supply		
24 V DC		
Surge protection Protection against polarity reversal Transient protection		
Analog inputs		
2, 3, 4-wire (shielded)		
Max. 4 (differential inputs, current)		
-		
0 mA ... 20 mA / 4 mA ... 20 mA / -20 mA ... 20 mA		
Characteristics		
16 bits (15 bits + sign bit)		
30 Hz, 12 kHz and mean-value generation (can be parameterized)		
0.1 % (of measuring range final value for active mean-value generation and 30 Hz filter)		
General data		
Push-in technology		
0.2 ... 1.5 mm ² / 0.2 ... 1.5 mm ² / 24 - 16		
145 g		
35 mm / 126.1 mm / 54 mm		

Description	Axioline analog input module , complete with accessories (bus base module) - 4 inputs - 8 inputs - for extended temperature range of -40°C ... +70°C
-------------	--

Ordering data

Type	Order No.	Pcs. / Pkt.
AXL F AI4 I 1H	2688491	1
AXL F AI4 I XC 1H	2702007	1

Axioline bus base module (replacement part)	AXL F BS H	2700992	5
Axioline shield connection set	AXL SHIELD SET	2700518	1

Accessories

Axioline bus base module (replacement part)	AXL F BS H	2700992	5
Axioline shield connection set	AXL SHIELD SET	2700518	1



4 inputs
Voltage signals



8 inputs

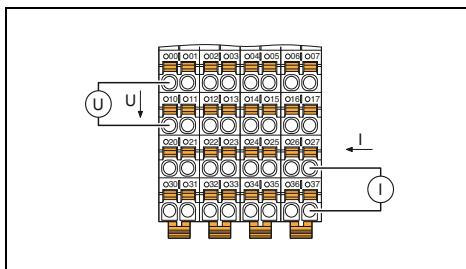
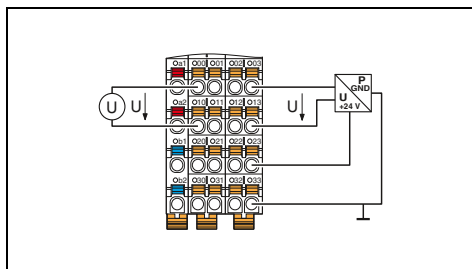

Technical data

Technical data

Axioline F local bus
Bus base module

Axioline F local bus
Bus base module

5 V DC (via bus base module)
Max. 150 mA

5 V DC (via bus base module)
Max. 130 mA

24 V DC
Surge protection
Protection against polarity reversal
Transient protection

24 V DC
Surge protection
Protection against polarity reversal
Transient protection

2, 3, 4-wire (shielded)
Max. 4 (differential inputs, voltage)

2-wire (shielded, twisted pair)
Max. 8 (differential inputs, voltage or current can be selected separately)

0 V ... 5 V / -5 V ... 5 V / 0 V ... 10 V / -10 V ... 10 V

0 V ... 5 V / -5 V ... 5 V / 0 V ... 10 V / -10 V ... 10 V
0 mA ... 20 mA / 4 mA ... 20 mA / -20 mA ... 20 mA

16 bits (15 bits + sign bit)
30 Hz, 12 kHz and mean-value generation (can be parameterized)

16 bits (15 bits + sign bit)
30 Hz, 12 kHz and mean-value generation (can be parameterized)

0.1 % (of measuring range final value for active mean-value generation and 30 Hz filter)

0.1 % (of measuring range final value for active mean-value generation and 30 Hz filter)

Push-in technology
0.2 ... 1.5 mm² / 0.2 ... 1.5 mm² / 24 - 16
145 g
35 mm / 126.1 mm / 54 mm

Push-in technology
0.2 ... 1.5 mm² / 0.2 ... 1.5 mm² / 24 - 16
204 g
53.6 mm / 126.1 mm / 54 mm

Ordering data

Ordering data

Type	Order No.	Pcs. / Pkt.
AXL F AI4 U 1H	2688501	1
AXL F AI4 U XC 1H	2702008	1

Type	Order No.	Pcs. / Pkt.
AXL AI 8	2688064	1
AXL F AI8 XC 1F	2701232	1

Accessories

Accessories

AXL F BS H	2700992	5
AXL SHIELD SET	2700518	1

AXL F BS F	2688129	5
AXL SHIELD SET	2700518	1

Analog output modules

These modules are designed for use within an Axioline F station.

They are used to output standard analog current and voltage signals. Connection is via 2-wire technology and a shield connection.

Features:

- Up to 8 analog bipolar outputs
- Current and voltage ranges
- Minimum update time of 250 μ s
- 16-bit output value
- Overload and short-circuit protected
- Stored device rating plate



4 outputs



8 outputs

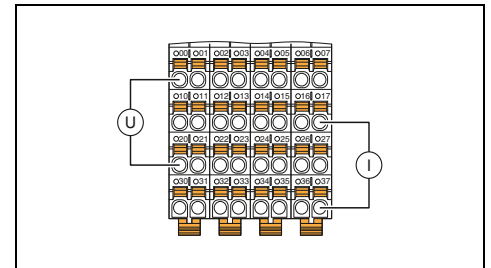
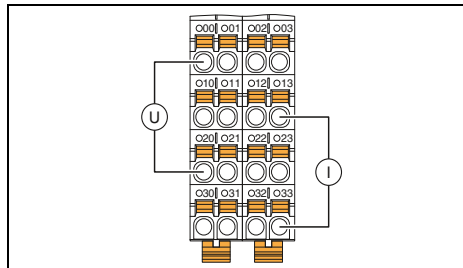

Technical data

Technical data

Local bus interface	
Designation	Axioline F local bus
Connection method	Bus base module
Power supply for module electronics	
Communications power U_{BUS}	5 V DC (via bus base module)
Current consumption from U_{BUS}	Max. 150 mA
I/O supply	
Supply of analog modules U_A	24 V DC
Analog outputs	
Connection technology	2-wire (shielded, twisted pair)
Number of outputs	4
Voltage output signal	0 V ... 5 V / -5 V ... 5 V / 0 V ... 10 V / -10 V ... 10 V
Current output signal	0 mA ... 20 mA / 4 mA ... 20 mA
Load/output load current output	$\leq 500 \Omega$
Protective circuit	Short-circuit and overload protection Transient protection
Characteristics	
Representation of output values	16 bits (15 bits + sign)
Accuracy	typ. 0.1 % (of output range final value)
General data	
Connection method	Push-in technology
Connection data solid / stranded / AWG	0.2 ... 1.5 mm ² / 0.2 ... 1.5 mm ² / 24 - 16
Weight	145 g
Dimensions	35 mm / 126.1 mm / 54 mm

Local bus interface	
Designation	Axioline F local bus
Connection method	Bus base module
Power supply for module electronics	
Communications power U_{BUS}	5 V DC (via bus base module)
Current consumption from U_{BUS}	Max. 130 mA
I/O supply	
Supply of analog modules U_A	24 V DC
Analog outputs	
Connection technology	2-wire (shielded, twisted pair)
Number of outputs	8
Voltage output signal	0 V ... 5 V / -5 V ... 5 V / 0 V ... 10 V / -10 V ... 10 V
Current output signal	0 mA ... 20 mA / 4 mA ... 20 mA / -20 mA ... 20 mA
Load/output load current output	$\leq 500 \Omega$
Protective circuit	Short-circuit and overload protection Transient protection
Characteristics	
Representation of output values	16 bits (15 bits + sign)
Accuracy	typ. 0.1 % (of output range final value)
General data	
Connection method	Push-in technology
Connection data solid / stranded / AWG	0.2 ... 1.5 mm ² / 0.2 ... 1.5 mm ² / 24 - 16
Weight	260 g
Dimensions	53.6 mm / 126.1 mm / 54 mm

Ordering data

Ordering data

Description	
Axioline analog output module , complete with accessories (bus base module)	
- 4 outputs	
- 8 outputs	
- for extended temperature range of -40°C ... +70°C	

Type	Order No.	Pcs. / Pkt.
AXL F AO4 1H	2688527	1
AXL F AO4 XC 1H	2702153	1

Type	Order No.	Pcs. / Pkt.
AXL AO 8	2688080	1
AXL F AO8 XC 1F	2701237	1

Accessories

Accessories

Axioline bus base module (replacement part)
Axioline shield connection set

AXL F BS H	2700992	5
AXL SHIELD SET	2700518	1

AXL F BS F	2688129	5
AXL SHIELD SET	2700518	1

new

Analog input and output modules

This module is designed for use within an Axioline F station.

It is used to acquire and output standard analog current and voltage signals. Connection is via 2-wire technology and a shield connection.

Features:

- 2 analog bipolar inputs and outputs each
- Current and voltage ranges
- Minimum update time of 250 µs
- 16-bit output value
- Overload and short-circuit protected
- Stored device rating plate

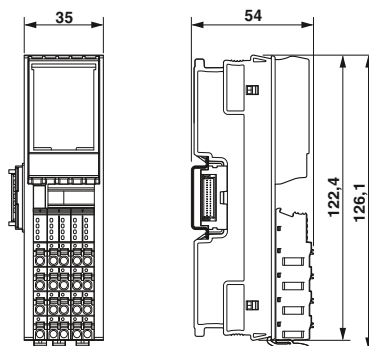

2 inputs and 2 outputs

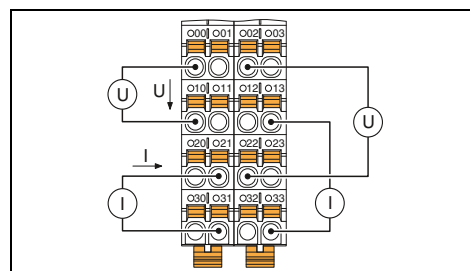

Local bus interface	
Designation	Axioline F local bus
Connection method	Bus base module
Power supply for module electronics	
Communications power U_{Bus}	5 V DC (via bus base module)
Current consumption from U_{Bus}	Max. 150 mA
I/O supply	
Supply of analog modules U_A	24 V DC
Analog inputs	
Connection technology	2-wire (shielded)
Number of inputs	Max. 2 (differential inputs, voltage or current can be selected separately)
Voltage input signal	0 V ... 5 V / -5 V ... 5 V / 0 V ... 10 V / -10 V ... 10 V
Current input signal	0 mA ... 20 mA / 4 mA ... 20 mA / -20 mA ... 20 mA
Analog outputs	
Connection technology	2-wire (shielded, twisted pair)
Number of outputs	2
Voltage output signal	0 V ... 5 V / -5 V ... 5 V / 0 V ... 10 V / -10 V ... 10 V
Current output signal	0 mA ... 20 mA / 4 mA ... 20 mA / -20 mA ... 20 mA
Load/output load current output	≤ 500 Ω
Protective circuit	Short-circuit and overload protection Transient protection
Characteristics	
Representation of output values	16 bits (15 bits + sign)
Accuracy	0.1 % (of measuring range final value for active mean-value generation and 30 Hz filter) typ. 0.1 % (of output range final value)
General data	
Connection method	Push-in technology
Connection data solid / stranded / AWG	0.2 ... 1.5 mm ² / 0.2 ... 1.5 mm ² / 24 - 16
Weight	200 g

Ordering data

Type	Order No.	Pcs. / Pkt.
AXL F AI2 AO2 1H	2702072	1

Accessories

AXL F BS H	2700992	5
AXL SHIELD SET	2700518	1

Description	Axioline analog I/O module , complete with accessories (bus base module)
-------------	---

AXIOLINE BUS BASE MODULE (replacement part)	
AXIOLINE SHIELD CONNECTION SET	

Temperature measurement modules

These modules are designed for use within an Axioline F station.

They are used to acquire data from resistive temperature sensors. Connection is via 2-, 3- or 4-wire technology and a shield connection.

RTD features:

- Up to 8 inputs for temperature shunts
- 500 Ω and 5 kΩ linear inputs
- Programmable filters
- Short-circuit-proof inputs
- Stored device rating plate

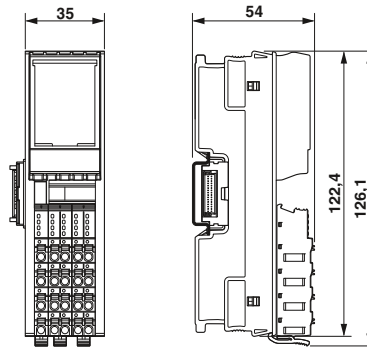

4 RTD inputs

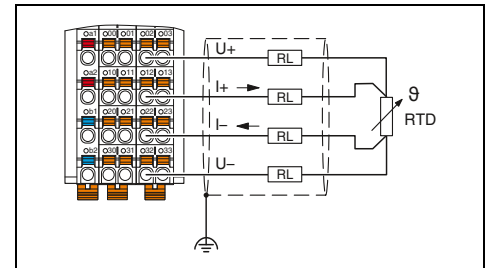

Technical data

Local bus interface	Axioline F local bus
Designation	Bus base module
Connection method	
Power supply for module electronics	5 V DC (via bus base module)
Communications power U_{Bus}	Max. 140 mA
Current consumption from U_{Bus}	
I/O supply	24 V DC
Supply of analog modules U_A	Surge protection
Protective circuit	Protection against polarity reversal
	Transient protection
Analog inputs	2, 3, 4-wire (shielded)
Connection technology	4 (for resistance temperature detectors)
Number of inputs	Short-circuit protection, overload protection of the inputs
Protective circuit	Transient protection of inputs
	Transient protection of sensor supplies
Sensor types (RTD) that can be used	Pt, Ni, KTY, Cu sensors
Linear resistance measuring range	0 Ω ... 500 Ω / 0 kΩ ... 5 kΩ
Characteristics	16 bits (15 bits + sign bit)
Measured value representation	40 ms / 60 ms / 100 ms / 120 ms (adjustable)
Input filter time	typ. ± 0.1 K (Pt 100 with 3-wire connection)
Accuracy	
General data	Push-in technology
Connection method	0.2 ... 1.5 mm ² / 0.2 ... 1.5 mm ² / 24 - 16
Connection data solid / stranded / AWG	144 g
Weight	35 mm / 126.1 mm / 54 mm
Dimensions	W / H / D

Ordering data

Description	Type	Order No.	Pcs. / Pkt.
Axioline analog input module , complete with accessories (bus base module)	AXL F RTD4 1H	2688556	1
- 4 inputs for connecting resistance temperature detectors			
- 8 inputs for connecting temperature shunts			
- for extended temperature range of -40°C ... +70°C			

Accessories

Accessories	Order No.	Pcs. / Pkt.
Axioline bus base module (replacement part)	2700992	5
Axioline shield connection set	2700518	1

new



8 RTD inputs



8 fast RTD inputs

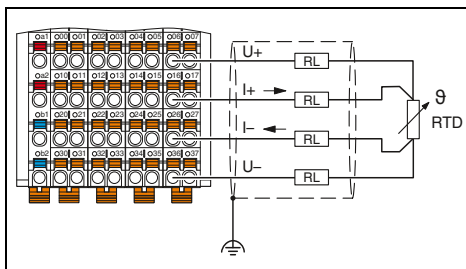
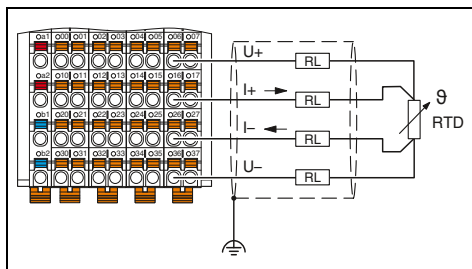

Technical data

Axioline F local bus
Bus base module

5 V DC (via bus base module)
Max. 180 mA

24 V DC
Surge protection
Protection against polarity reversal
Transient protection

2, 3, 4-wire (shielded)
8 (for resistance temperature detectors)
Short-circuit protection, overload protection of the inputs
Transient protection of inputs
Transient protection of sensor supplies
Pt, Ni, KTY, Cu sensors
0 Ω ... 500 Ω / 0 kΩ ... 5 kΩ

16 bits (15 bits + sign bit)
40 ms / 60 ms / 100 ms / 120 ms (adjustable)
typ. ± 0.1 K (Pt 100 with 3-wire connection)

Push-in technology
0.2 ... 1.5 mm² / 0.2 ... 1.5 mm² / 24 - 16
215 g
53.6 mm / 126.1 mm / 54 mm

Ordering data

Type	Order No.	Pcs. / Pkt.
AXL F RTD8 1F	2688077	1
AXL F RTD8 XC 1F	2701235	1

Accessories

AXL F BS F	2688129	5
AXL SHIELD SET	2700518	1

Technical data

Axioline F local bus
Bus base module

5 V DC (via bus base module)
Max. 180 mA

24 V DC
Surge protection
Protection against polarity reversal
Transient protection

2, 4-wire (shielded)
8 (for resistance temperature detectors)
Short-circuit protection, overload protection of the inputs
Transient protection of inputs
Transient protection of sensor supplies
Pt, Ni, Cu sensors
0 Ω ... 500 Ω

16 bits (15 bits + sign bit)
8 ms / 16 ms / 32 ms / 120 ms (adjustable)
typ. ± 0.1 K (Pt 100 with 4-wire connection)

Push-in technology
0.2 ... 1.5 mm² / 0.2 ... 1.5 mm² / 24 - 16
215 g
53.6 mm / 126.1 mm / 54 mm

Ordering data

Type	Order No.	Pcs. / Pkt.
AXL F RTD8 S 1F	2702120	1

Accessories

AXL F BS F	2688129	5
AXL SHIELD SET	2700518	1

Temperature measurement modules

These modules are designed for use within an Axioline F station.

They are used to acquire data from thermocouples. Connection is via 2-wire technology and a shield connection.

Features of UTH:

- Up to 8 inputs for thermocouples
- Linear voltages from -100 mV to +100 mV
- 1 input from -5 V to +5 V
- 4 Pt 100 inputs (external cold junction)
- Configurable cold junction type
- Stored device rating plate



4 UTH inputs



8 UTH inputs

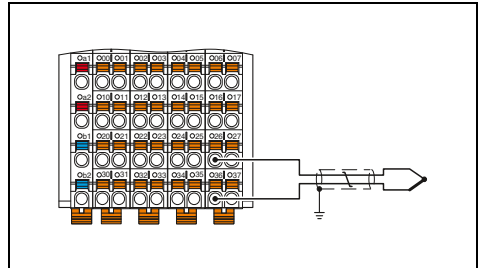
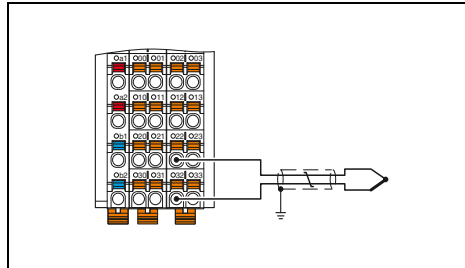

Technical data

Local bus interface	Axioline F local bus
Designation	Bus base module
Connection method	
Power supply for module electronics	5 V DC (via bus base module)
Communications power U_{BUS}	Max. 160 mA
Current consumption from U_{BUS}	
I/O supply	24 V DC
Supply of analog modules U_A	Surge protection of the supply voltage
Protective circuit	Polarity reversal protection of the supply voltage Transient protection
Analog inputs	
Connection technology	2-wire (shielded, twisted pair)
Number of inputs	4 + 1 (4 inputs for thermocouples or linear voltage, plus 1 input -5 V to +5 V)
Protective circuit	Short-circuit protection, overload protection of the inputs Transient protection of inputs
Sensor types (RTD) that can be used	Pt 100 (2 external cold junctions, can also be used as a sensor input)
Linear voltage range	-100 mV ... 100 mV
Characteristics	
Measured value representation	16 bits (15 bits + sign bit)
Input filter time	40 ms / 60 ms / 100 ms / 120 ms (adjustable)
Accuracy	typ. ± 0.19 K (thermocouple type K, plus tolerance of cold junction)
General data	
Connection method	Push-in technology
Connection data solid / stranded / AWG	0.2 ... 1.5 mm ² / 0.2 ... 1.5 mm ² / 24 - 16
Weight	144 g
Dimensions	35 mm / 126.1 mm / 54 mm

Technical data

Local bus interface	Axioline F local bus
Designation	Bus base module
Connection method	
Power supply for module electronics	5 V DC (via bus base module)
Communications power U_{BUS}	Max. 180 mA
Current consumption from U_{BUS}	
I/O supply	24 V DC
Supply of analog modules U_A	Surge protection of the supply voltage
Protective circuit	Polarity reversal protection of the supply voltage Transient protection
Analog inputs	
Connection technology	2-wire (shielded, twisted pair)
Number of inputs	8 + 1 (8 inputs for thermocouples or linear voltage, plus 1 input -5 V to +5 V)
Protective circuit	Short-circuit protection, overload protection of the inputs Transient protection of inputs
Sensor types (RTD) that can be used	Pt 100 (4 external cold junctions, can also be used as a sensor input)
Linear voltage range	-100 mV ... 100 mV
Characteristics	
Measured value representation	16 bits (15 bits + sign bit)
Input filter time	40 ms / 60 ms / 100 ms / 120 ms (adjustable)
Accuracy	typ. ± 0.19 K (thermocouple type K, plus tolerance of cold junction)
General data	
Connection method	Push-in technology
Connection data solid / stranded / AWG	0.2 ... 1.5 mm ² / 0.2 ... 1.5 mm ² / 24 - 16
Weight	203 g
Dimensions	53.6 mm / 126.1 mm / 54 mm

Ordering data

Description	Type	Order No.	Pcs. / Pkt.
Axioline analog input module , complete with accessories (bus base module)			
- 4 inputs for connection of thermocouple sensors	AXL F UTH4 1H	2688598	1
- 8 inputs for connection of thermocouple sensors			

Ordering data

Description	Type	Order No.	Pcs. / Pkt.
Axioline analog input module , complete with accessories (bus base module)			
- 8 inputs for connection of thermocouple sensors	AXL UTH 8	2688417	1

Accessories

Accessories	Type	Order No.	Pcs. / Pkt.
Axioline bus base module (replacement part)	AXL F BS H	2700992	5
Axioline shield connection set	AXL SHIELD SET	2700518	1

Accessories

Accessories	Type	Order No.	Pcs. / Pkt.
Axioline bus base module (replacement part)	AXL F BS F	2688129	5
Axioline shield connection set	AXL SHIELD SET	2700518	1

Serial communication module

This module is designed for use within an Axioline F station.

It is used to connect devices with a serial interface, e.g., barcode scanners.

Features:

- Baud rates of up to 250 kBaud
- Communication via acyclic services or process data
- Support for various protocols (e.g., end-to-end protocol)
- 5 RS-232 hardware handshake signals with status indication via LEDs
- Integrated RS-485/RS-422 termination resistor

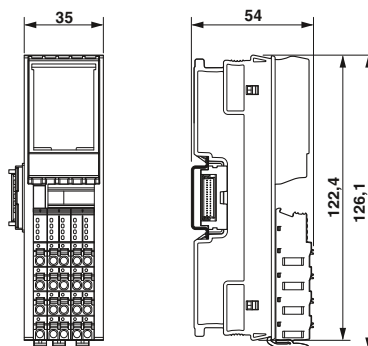

1 serial input and output channel as RS-485/422 or RS-232 version

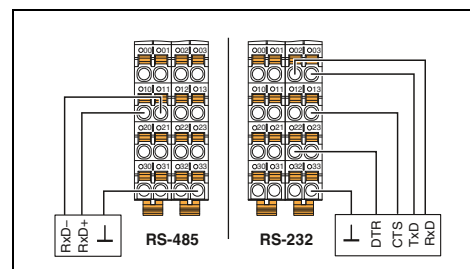

Technical data

Local bus interface	
Designation	Axioline F local bus
Connection method	Bus base module
Serial port	
Interface	RS-232, RS-485, RS-422
Connection method	Push-in technology
Power supply for module electronics	
Communications power U_{Bus}	5 V DC (via bus base module)
Current consumption from U_{Bus}	typ. 200 mA
Serial input/output channel	
Input buffer	4 kbyte
Output buffer	1 kbyte
Transmission speed	110 bps ... 250 kbps (can be parameterized)
Data bits	5 ... 8
Stop bits	1 or 2
Parity	Even, odd or no parity
Transmission type	Transparent mode, end-to-end mode, XON/XOFF, Modbus RTU
General data	
Connection method	Push-in technology
Connection data solid / stranded / AWG	0.2 ... 1.5 mm ² / 0.2 ... 1.5 mm ² / 24 - 16
Weight	135 g

Ordering data

Description	Type	Order No.	Pcs. / Pkt.
Axioline communication module , complete with accessories (bus base module)			
- 1 serial input and output channel as RS-485/RS-422 or RS-232 version	AXL F RS UNI 1H	2688666	1
- for extended temperature range of -40°C ... +70°C	AXL F RS UNI XC 1H	2702006	1

Accessories

Axioline bus base module (replacement part)	AXL F BS H	2700992	5
Axioline shield connection set	AXL SHIELD SET	2700518	1

Function/position detection module

This module is designed for use within an Axioline F station.

It is used for counting pulses and for position detection using incremental encoders.

Features:

- Two counter inputs (32-bit)
- Two incremental encoder interfaces (32-bit)
- Symmetrical or asymmetrical encoders can be connected
- Maximum frequency of 300 kHz
- Eight digital inputs (gate, direction signal, latch, home position switch)
- Two digital outputs
- 5 V and 24 V sensor/encoder supply
- Encoder monitoring
- Rotary axis function
- Ten homing methods

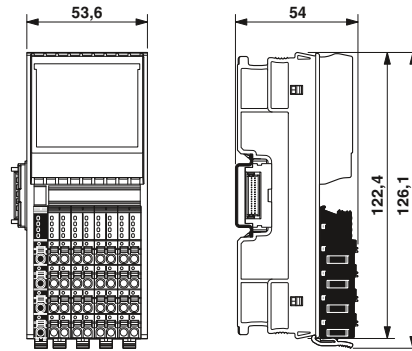

**2 counter inputs,
2 incremental encoder interfaces**

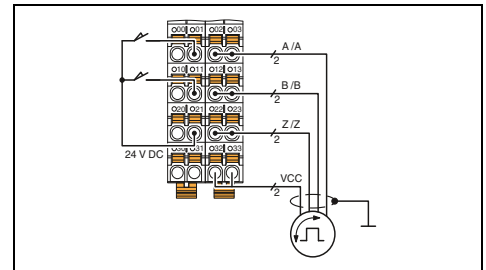

Technical data

Local bus interface	Axioline F local bus
Designation	Bus base module
Connection method	
Power supply for module electronics	
Communications power U_{Bus}	5 V DC (via bus base module)
Current consumption from U_{Bus}	typ. 100 mA
I/O supply	
Supply of digital input modules U_i	24 V DC
Supply voltage range U_i	19.2 V DC ... 30 V DC (including all tolerances, including ripple)
Protective circuit	Surge protection Polarity reversal protection of the supply voltage
Counter input	
Number of inputs	2 (S1, S2)
Input frequency	Max. 300 kHz (1 channel wired)
Input voltage	24 V DC
Encoder inputs	
Number of inputs	2 (A1, /A1, B1, /B1, Z1, /Z1; A2, /A2, B2, /B2, Z2, /Z2)
Encoder signals	Symmetrical and asymmetrical encoders
Input frequency	Max. 300 kHz (1 channel wired)
Digital inputs	
Connection technology	1-wire (optionally 2, 3-wire)
Number of inputs	8 (CNT: G1, G2, Dir1, Dir2; INC: Ref1, Ref2, L1, L2)
Description of the inputs	EN 61131-2, type 3
Nominal input voltage U_{IN}	24 V DC
Nominal input current at U_{IN}	2.5 mA (per channel)
Digital outputs	
Number of outputs	2 (Out1, Out2)
Output voltage	24 V DC
Maximum output current per channel	500 mA
Protective circuit	Short-circuit protection, overload protection of the outputs
General data	
Connection method	Push-in technology
Connection data solid / stranded / AWG	0.2 ... 1.5 mm ² / 0.2 ... 1.5 mm ² / 24 - 16
Weight	205 g

Ordering data

Description	Type	Order No.	Pcs. / Pkt.
Axioline special function module			
- 2 counter inputs, 2 incremental encoder inputs	AXL CNT 2/INC 2	2688093	1
- for extended temperature range of -40°C ... +70°C	AXL F CNT2 INC2 XC 1F	2701239	1

Accessories

Axioline bus base module (replacement part)	AXL F BS F	2688129	5
Axioline shield connection set	AXL SHIELD SET	2700518	1

Position detection module

This module is designed for use within an Axioline F station.

It is used to detect positions using an absolute encoder with an SSI interface.

At the same time, an analog output can be used for defining the setpoint of a drive controller, for example.

Features:

- Position detection using absolute encoders with SSI interface
- Encoder resolution up to 56 bits
- Transmission frequency of up to 2 MHz
- Gray or binary code
- Reversal of direction of rotation
- Synchronized transmission of encoder values
- Detailed encoder diagnostics
- Current and voltage measuring ranges
- 16-bit resolution of the analog output value
- D/A conversion time typically 5 μs

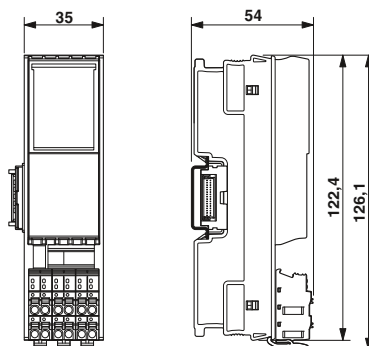

1 SSI interface for absolute encoder, 1 analog output

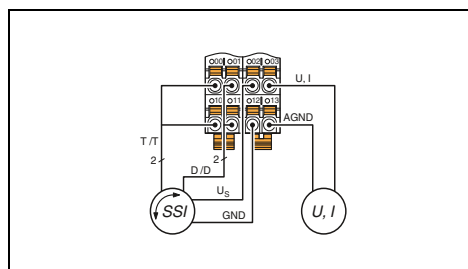

Technical data	
Local bus interface	
Designation	Axioline F local bus
Connection method	Bus base module
Power supply for module electronics	
Communications power U_{Bus}	5 V DC (via bus base module)
Current consumption from U_{Bus}	Max. 140 mA
I/O supply	
Supply U_1	24 V DC
Protective circuit	Surge protection Protection against polarity reversal Transient protection
Encoder inputs	
Input name	SSI interface
Number of inputs	1
Transmission frequency	2 MHz
Adjustable resolution	8 ... 56
Analog outputs	
Connection technology	2-wire (shielded, twisted pair)
Number of outputs	1
Voltage output signal	0 V ... 5 V / -5 V ... 5 V / 0 V ... 10 V / -10 V ... 10 V
Current output signal	0 mA ... 20 mA / 4 mA ... 20 mA / -20 mA ... 20 mA
Load/output load current output	Max. 500 Ω
Protective circuit	Surge protection Short-circuit and overload protection Transient protection
Accuracy	typ. 0.1 % (of output range final value)
Characteristics	
Representation of output values	16 bits (15 bits + sign)
General data	
Connection method	Push-in technology
Connection data solid / stranded / AWG	0.2 ... 1.5 mm ² / 0.2 ... 1.5 mm ² / 24 - 16
Weight	135 g

Ordering data		
Type	Order No.	Pcs. / Pkt.
AXL SSI 1/AO 1	2688433	1

Accessories		
AXL F BS H	2700992	5
AXL SHIELD SET	2700518	1

Description	
Axioline special function module	
- 1 SSI interface for absolute encoder, 1 analog output	
Axioline bus base module (replacement part)	
Axioline shield connection set	

Product overview

Bus coupler



EtherNet/IP	Modbus/TCP (UDP)	SERCOS the automation bus	PROFIBUS NET	CANopen	DeviceNet	INTERBUS	Modbus/RTU	PROFIBUS DI	MUX
168	168	169	169	170	170	171	172	173	173

Power, segment, and accessory terminals



Power terminals			Boost terminals	Segment terminals		Potential distributor terminals	
24 V DC	120 V AC	230 V AC		24 V DC		24 V DC	GND
174	175	175	176	178		179	179

Input and output terminals



Digital input						
1 channel	2 channels	4 channels	8 channels	16 channels	32 channels	
184	180	180	181	180	181	
Digital output						
1 channel	2 channels	4 channels	8 channels	16 channels	32 channels	
190	186	186	186	186	187	
Analog input		Strain gauge		Analog output		
2 channels	4 channels	8 channels	2 channels	1 channel	2 channels	8 channels
192	194	193	196	200	200	201
Temperature measurement terminals						
1 channel (TC)	2 channels (UTH/RTD)	4/8 channels (RTD)				
199	198	199				

Machine Edition (ME)



Digital input	Digital output	Analog input	Analog output
4/16 channels	4/16 channels	2 channels	2 channels
202	202	203	203

Building automation



DALI terminals
208

Branch terminals



Remote bus branch, Fieldline extension, line skipping
204

Communication terminals



Serial communication terminals		Master terminals			
RS-232	RS-485	INTERFACE system bus	CAN	IO-Link	PROFIBUS
206	207	209	210	211	212

Measurement terminals



Position detection terminals
216

Open and closed-loop control



Temperature controller terminals		Function terminals		Positioning control terminals	
RTD sensors	UTH sensors	Counter terminal	Pulse width terminal	INC	SSI
phoenixcontact.net/products		213	214	218	218

Power-level terminals



Servo amplifier EC motors	Direct starter	Reversing load starter
219	220	220

Intrinsically safe terminals (Ex-i)



PWR	DIO	AIO	TEMP
24 V	4/4 channels	4/4 channels	4 channels (RTD/TC)
432	433	433	433

PC Worx programmable terminals – Inline controllers



	100	Performance class	200	300
	474		phoenixcontact.net/products	478

Safety terminals



	Logic modules	Safety-related I/Os	
	8 channels	8 channels	4 channels
	82	83	85

General accessories

IB IL FIELD ... Marking fields	ESL 62X... Marking sheets	ZBF 6-... Zack marker strip marking	IL CP Coding profile	CLIPFIX 35-5 Standard end bracket	CLIPFIX 35 End clamp for CANopen® and DeviceNet™ bus couplers	E/AL-NS 35 End clamp for use in the event of vibrations

phoenixcontact.net/products

FLKM 14-PA-INLINE/... VARIOFACE front adapters	PSM-SET-FSMA/4-... F-SMA connectors for INTERBUS FO	IBS DSUB 9/... D-SUB 9 connectors	SUBCON ... SUBCON connectors	I-L ATP GN End cover plate	...-CABLE-...	PROJECT+ Software for planning the I/O configuration

phoenixcontact.net/products

454

General technical data

Ambient conditions

Operating temperature range	-25°C ... +55°C
- extended (...-XC modules)	-40°C ... +70°C
Storage temperature	-25°C ... +85°C
Relative humidity (operation)	5% to 95% (non-condensing)
Relative humidity (storage)	5% to 95% (non-condensing)
Vibration	5g, 2 hours in each space direction according to IEC 60068-2-6
Shock	25g, over 11 ms according to IEC 60068-2-6
Degree of protection	IP20 (according to IEC 60529)

Electromagnetic compatibility

Noise emission	EN 61000-6-3
Noise emission of housing	EN 55011 Class A
Noise immunity	EN 61000-6-2

Supply voltage

Nominal value	24 V DC
Ripple	±5%
Permissible range	19.2 V ... 30.0 V

Bus couplers

The Inline bus couplers are the link between the Inline system and the higher-level network.

Features:

- 8 digital inputs, 4 digital outputs onboard
- Automatic speed detection of the system bus
- Up to 61 terminals (maximum of 16 PCP devices) can be connected

EtherNet/IP



2-port RJ45 copper connection, 8 digital inputs and 4 digital outputs

Modbus/TCP (UDP)



2-port RJ45 copper connection, 8 digital inputs and 4 digital outputs

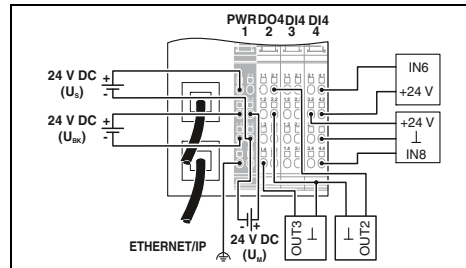

Technical data

Interface	
Fieldbus system	EtherNet/IP™
Connection method	RJ45 socket, auto negotiation and auto crossing
Transmission speed	10/100 Mbps (half or full duplex (automatic detection))
Local bus interface	
Connection method	Inline data jumper
Number of local bus devices that can be connected	Max. 61 (on board I/Os are two devices)
Power supply for module electronics	
Supply voltage	24 V DC (via Inline connector)
Supply voltage range	19.2 V DC ... 30 V DC (including all tolerances, including ripple)
Max. current consumption	Max. 0.98 A (from U _{BK})
Power supply at U _L	Max. 0.8 A DC
Power supply at U _{ANA}	Max. 0.5 A DC
Digital inputs	
Connection technology	2, 3-wire
Number of inputs	8 (EN 61131-2 type 1)
Typical response time	approx. 500 µs
Protective circuit	Protection against polarity reversal
Digital outputs	
Connection technology	2, 3-wire
Number of outputs	4
Maximum output current per channel	500 mA
Protective circuit	Short-circuit and overload protection
General data	
Connection technology	Spring-cage connection
Connection data solid / stranded / AWG	0.08 ... 1.5 mm ² / 0.08 ... 1.5 mm ² / 28 - 16
Dimensions	80 mm / 119.8 mm / 71.5 mm
Ambient temperature (operation)	-25 °C ... 55 °C
EMC note	Class A product, see page 527

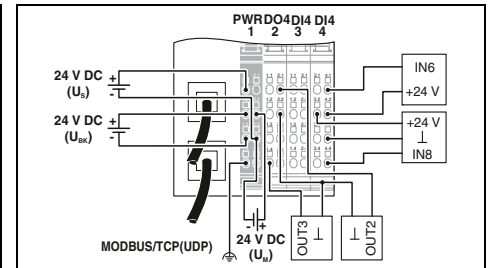

Technical data

Interface	
Fieldbus system	Modbus/TCP (UDP)
Connection method	RJ45 socket, auto negotiation
Transmission speed	10/100 Mbps
Local bus interface	
Connection method	Inline data jumper
Number of local bus devices that can be connected	Max. 61 (on board I/Os are two devices)
Power supply for module electronics	
Supply voltage	24 V DC (via Inline connector)
Supply voltage range	19.2 V DC ... 30 V DC (including all tolerances, including ripple)
Max. current consumption	Max. 0.98 A (from U _{BK})
Power supply at U _L	Max. 0.8 A DC
Power supply at U _{ANA}	Max. 0.5 A DC
Digital inputs	
Connection technology	2, 3-wire
Number of inputs	8 (EN 61131-2 type 1)
Typical response time	approx. 500 µs
Protective circuit	Protection against polarity reversal
Digital outputs	
Connection technology	2, 3-wire
Number of outputs	4
Maximum output current per channel	500 mA
Protective circuit	Short-circuit and overload protection
General data	
Connection technology	Spring-cage connection
Connection data solid / stranded / AWG	0.08 ... 1.5 mm ² / 0.08 ... 1.5 mm ² / 28 - 16
Dimensions	80 mm / 119.8 mm / 71.5 mm
Ambient temperature (operation)	-25 °C ... 55 °C
EMC note	Class A product, see page 527

Ordering data

Description	
Bus coupler , complete with accessories (connector plug and marking field)	
- for extended temperature range of -40°C ... +70°C	

Type	Order No.	Pcs. / Pkt.
IL EIP BK DI8 DO4 2TX-PAC	2897758	1
IL EIP BK DI8 DO4 2TX-XC-PAC	2702131	1

Accessories

Connector set for bus coupler	
-------------------------------	--

IL BKDIO-PLSET	2878599	1
----------------	---------	---

Ordering data

Type	Order No.	Pcs. / Pkt.
IL ETH BK DI8 DO4 2TX-PAC	2703981	1
IL ETH BK DI8 DO4 2TX-XC-PAC	2701388	1

Accessories

IL BKDIO-PLSET	2878599	1
----------------	---------	---



2-port RJ45 copper connection,
8 digital inputs and 4 digital outputs



2-port RJ45 copper connection,
8 digital inputs and 4 digital outputs



2-port SC-RJ FO connection,
8 digital inputs and 4 digital outputs

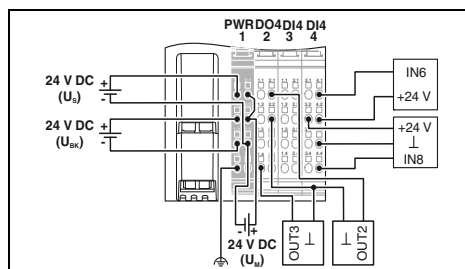
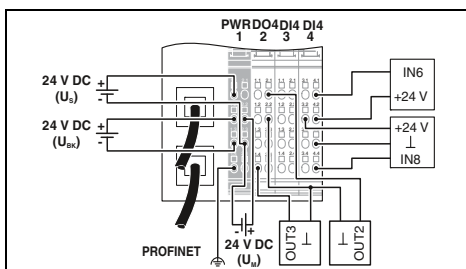
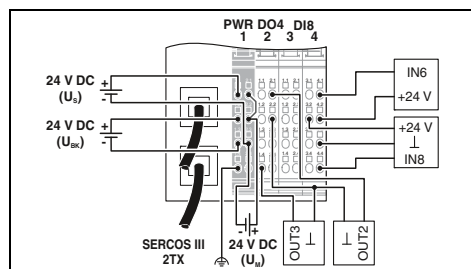

Technical data

Technical data

Technical data

Sercos
RJ45 socket, auto negotiation
100 Mbps

PROFINET
RJ45 socket, auto negotiation
100 Mbps (according to PROFINET standard)

PROFINET
SC-RJ socket
100 Mbps (according to PROFINET standard)

Inline data jumper
Max. 61 (on board I/Os are two devices)

Inline data jumper
Max. 61 (on board I/Os are two devices)

Inline data jumper
Max. 61 (on board I/Os are two devices)

24 V DC (via Inline connector)
19.2 V DC ... 30 V DC (including all tolerances, including ripple)

24 V DC (via Inline connector)
19.2 V DC ... 30 V DC (including all tolerances, including ripple)

24 V DC (via Inline connector)
19.2 V DC ... 30 V DC (including all tolerances, including ripple)

Max. 1.05 A (from U_{BK})
Max. 0.8 A DC
Max. 0.5 A DC

typ. 138 mA (from U_{BK})
Max. 0.8 A DC
Max. 0.5 A DC

Max. 0.83 A DC (from U_{BK})
Max. 0.8 A DC
Max. 0.5 A DC

2, 3-wire
8 (EN 61131-2 type 1)
approx. 500 µs
Protection against polarity reversal

2, 3-wire
8 (EN 61131-2 type 1)
approx. 500 µs
Protection against polarity reversal

2, 3-wire
8 (EN 61131-2 type 1)
approx. 500 µs
Protection against polarity reversal

2, 3-wire
4
500 mA
Short-circuit and overload protection

2, 3-wire
4
500 mA
Short-circuit and overload protection

2, 3-wire
4
500 mA
Short-circuit and overload protection

Spring-cage connection
0.08 ... 1.5 mm² / 0.08 ... 1.5 mm² / 28 - 16
80 mm / 119.8 mm / 71.5 mm
-25 °C ... 60 °C
Class A product, see page 527

Spring-cage connection
0.08 ... 1.5 mm² / 0.08 ... 1.5 mm² / 28 - 16
80 mm / 119.8 mm / 71.5 mm
-25 °C ... 55 °C (observe derating)
Class A product, see page 527

Spring-cage connection
0.08 ... 1.5 mm² / 0.08 ... 1.5 mm² / 28 - 16
80 mm / 119.8 mm / 71.5 mm
-25 °C ... 55 °C (observe derating)
Class A product, see page 527

Ordering data

Ordering data

Ordering data

Type	Order No.	Pcs. / Pkt.
IL S3 BK DI8 DO4 2TX-PAC	2692380	1

Type	Order No.	Pcs. / Pkt.
IL PN BK DI8 DO4 2TX-PAC	2703994	1

Type	Order No.	Pcs. / Pkt.
IL PN BK DI8 DO4 2SCRJ-PAC	2878379	1

Accessories

Accessories

Accessories

IB IL SCN-8-CP	2727608	10
----------------	---------	----

IL BKDIO-PLSET	2878599	1
----------------	---------	---

IL BKDIO-PLSET	2878599	1
----------------	---------	---

Bus couplers

The Inline bus couplers are the link between the Inline system and the higher-level network.

Features:

- Up to 63 terminals (maximum of 16 PCP devices) can be connected

CANopen® and DeviceNet™

features:

- Address can be set via DIP switches or software

CANopen



MINI-COMBICON connection

DeviceNet



MINI-COMBICON connection, 8 digital inputs and 4 digital outputs

UL US ENEC
Ex:

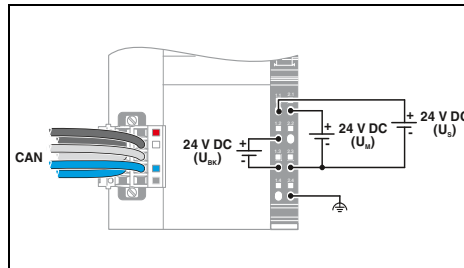

Technical data

UL US ENEC
Ex:

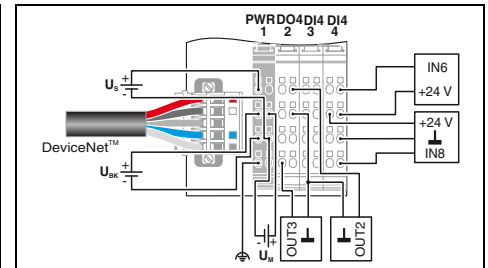

Technical data

Interface	
Fieldbus system	CANopen®
Connection method	2x 5-pos. TWIN-COMBICON connectors
Transmission speed	1 MBaud, 500 kBaud, 250 kBaud, 125 kBaud, 50 kBaud, 20 kBaud, 10 kBaud (can be set via DIP switch or programmed)
Local bus interface	
Connection method	Inline data jumper
Number of local bus devices that can be connected	Max. 63
Maximum distance to the next remote bus device	-
Power supply for module electronics	
Supply voltage	24 V DC
Supply voltage range	19.2 V DC ... 30 V DC (including all tolerances, including ripple)
Max. current consumption	Max. 1.25 A (from U _{BK})
Power supply at U _L	Max. 2 A DC
Power supply at U _{ANA}	Max. 0.5 A DC
Digital inputs	
Connection technology	-
Number of inputs	-
Typical response time	-
Protective circuit	-
Digital outputs	
Connection technology	-
Number of outputs	-
Maximum output current per channel	-
Protective circuit	-
General data	
Connection technology	Spring-cage connection
Connection data solid / stranded / AWG	0.08 ... 1.5 mm ² / 0.08 ... 1.5 mm ² / 28 - 16
Dimensions	85 mm / 119.8 mm / 71.5 mm
Ambient temperature (operation)	-25 °C ... 55 °C
EMC note	Class A product, see page 527

Interface	
Fieldbus system	DeviceNet™
Connection method	2x 5-pos. TWIN-COMBICON connectors
Transmission speed	500 kbps, 250 kbps, 125 kbps (can be set via DIP switch or programmed)
Local bus interface	
Connection method	Inline data jumper
Number of local bus devices that can be connected	Max. 61 (on board I/Os are two devices)
Maximum distance to the next remote bus device	-
Power supply for module electronics	
Supply voltage	24 V DC (via Inline connector)
Supply voltage range	19.2 V DC ... 30 V DC (including all tolerances, including ripple)
Max. current consumption	Max. 0.9 A (from U _{BK})
Power supply at U _L	Max. 0.8 A DC
Power supply at U _{ANA}	Max. 0.5 A DC
Digital inputs	
Connection technology	2, 3-wire
Number of inputs	8 (EN 61131-2 type 1)
Typical response time	approx. 500 µs
Protective circuit	Protection against polarity reversal
Digital outputs	
Connection technology	2, 3-wire
Number of outputs	4
Maximum output current per channel	500 mA
Protective circuit	Short-circuit and overload protection
General data	
Connection technology	Spring-cage connection
Connection data solid / stranded / AWG	0.08 ... 1.5 mm ² / 0.08 ... 1.5 mm ² / 28 - 16
Dimensions	80 mm / 119.8 mm / 71.5 mm
Ambient temperature (operation)	-25 °C ... 55 °C
EMC note	Class A product, see page 527

Description	
Bus coupler , complete with accessories (connector plug and marking field)	
- for extended temperature range of -40°C ... +70°C	
- 45° angled fiber optic connection	
- FO connection and FO remote bus branch	

Ordering data		
Type	Order No.	Pcs. / Pkt.
IL CAN BK-TC-PAC	2718701	1
IL CAN BK-TC-XC-PAC	2702130	1

Inline connector

Accessories		
IB IL SCN-8-CP	2727608	10

Ordering data		
Type	Order No.	Pcs. / Pkt.
IL DN BK DI8 DO4-PAC	2897211	1

Accessories		
IL BKDIO-PLSET	2878599	1



Inline shield connector connection

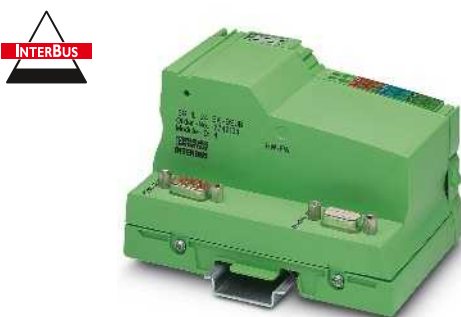

D-SUB connection



45° angled fiber optic connection

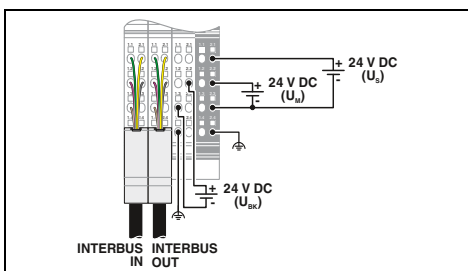

Technical data

INTERBUS
2x 6-pos. Inline shield connectors
500 kbps

Inline data jumper
Max. 63
400 m

24 V DC (via Inline connector)
19.2 V DC ... 30 V DC (including all tolerances, including ripple)

Max. 1.25 A (with max. number of connected I/O terminal blocks)

Max. 2 A DC (observe derating)
Max. 0.5 A DC (observe derating)

-
-
-
-
-
-

Spring-cage connection
0.08 ... 1.5 mm² / 0.08 ... 1.5 mm² / 28 - 16
48.8 mm / 135 mm / 71.5 mm
-25 °C ... 55 °C
Class A product, see page 527

Ordering data

Type	Order No.	Pcs. / Pkt.
IBS IL 24 BK-T/U-PAC	2861580	1
IBS IL 24 BK-T/U-XC-PAC	2701150	1

Accessories

IB IL BK-PLSET/CP	2860374	1
-------------------	---------	---

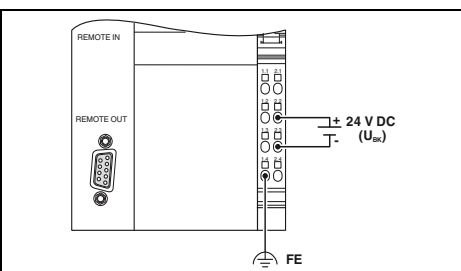

Technical data

INTERBUS
D-SUB-9 socket/D-SUB-9 connector
500 kbps

Inline data jumper
Max. 63
400 m

24 V DC (via Inline connector)
19.2 V DC ... 30 V DC (including all tolerances, including ripple)

Max. 1.25 A (with max. number of connected I/O terminal blocks)

Max. 2 A DC (observe derating)
Max. 0.5 A DC (observe derating)

-
-
-
-
-
-

Spring-cage connection
0.08 ... 1.5 mm² / 0.08 ... 1.5 mm² / 28 - 16
85 mm / 119.8 mm / 71.5 mm
-25 °C ... 55 °C
Class A product, see page 527

Ordering data

Type	Order No.	Pcs. / Pkt.
IBS IL 24 BK-DSUB-PAC	2861593	1

Accessories

IB IL SCN-8-CP	2727608	10
----------------	---------	----

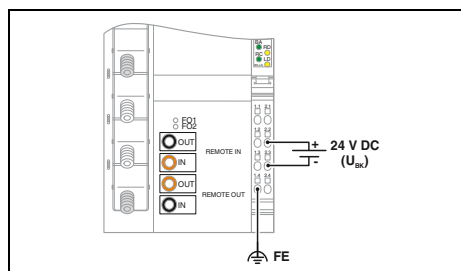

Technical data

IBS IL 24 BK-LK/45-PAC IBS IL 24 BK RB-LK-PAC

INTERBUS
4x F-SMA angled connectors 6x F-SMA connectors
500 kbps

Inline data jumper
Max. 63
400 m

24 V DC (via Inline connector)
19.2 V DC ... 30 V DC (including all tolerances, including ripple)

Max. 1.25 A (with max. number of connected I/O terminal blocks) Max. 1.3 A (with max. number of connected I/O terminal blocks)

Max. 2 A DC (observe derating)
Max. 0.5 A DC (observe derating)

-
-
-
-
-
-

Spring-cage connection
0.08 ... 1.5 mm² / 0.08 ... 1.5 mm² / 28 - 16
85 mm / 119.8 mm / 71.5 mm
-25 °C ... 55 °C
Class A product, see page 527

Ordering data

Type	Order No.	Pcs. / Pkt.
IBS IL 24 BK-LK/45-PAC	2862165	1
IBS IL 24 BK RB-LK-PAC	2861506	1

Accessories

IL BKDIO-PLSET	2878599	1
----------------	---------	---

Bus couplers

The Inline bus couplers are the link between the Inline system and the higher-level network.

Bus coupler features:

- Up to 63 terminals (16 PCP devices) can be connected
- Address can be set via rotary coding or DIP switches

The **field multiplexer**, together with the connected I/O terminals, forms one station. A system consists of a station and remote station with complementary arrangement of the I/O terminals.

MUX features:

- Maximum of 32 terminals per station
- Up to 512 digital or 32 analog I/Os (or a mixture) can be connected

Digital and analog Inline I/O terminals that can be used on the field multiplexer are indicated in this catalog with the adjacent logo.

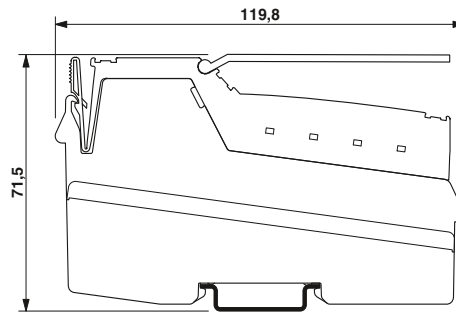

Modbus/RTU



**D-SUB connection,
8 digital inputs and 4 digital outputs**

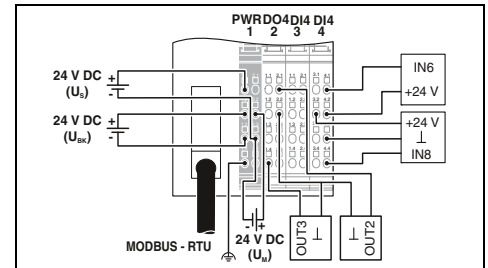

Technical data

Interface	
Fieldbus system	Modbus/RTU
Connection method	D-SUB-9 socket
Transmission speed	1.2 kbps ... 115.2 kbps
Local bus interface	
Connection method	Inline data jumper
Number of local bus devices that can be connected	Max. 61 (on board I/Os are two devices)
Power supply for module electronics	
Supply voltage	24 V DC (via Inline connector)
Supply voltage range	19.2 V DC ... 30 V DC (including all tolerances, including ripple)
Max. current consumption	Max. 0.98 A (from U _{BK})
Power supply at U _L	Max. 0.8 A DC
Power supply at U _{ANA}	Max. 0.5 A DC
Digital inputs	
Connection technology	2, 3-wire
Number of inputs	8 (EN 61131-2 type 1)
Typical response time	approx. 500 µs
Protective circuit	Protection against polarity reversal
Digital outputs	
Connection technology	2, 3-wire
Number of outputs	4
Maximum output current per channel	500 mA
Protective circuit	Short-circuit and overload protection
General data	
Connection method	Spring-cage connection
Connection data solid / stranded / AWG	0.08 ... 1.5 mm ² / 0.08 ... 1.5 mm ² / 28 - 16
Dimensions	80 mm / 119.8 mm / 71.5 mm
Ambient temperature (operation)	-25 °C ... 60 °C
EMC note	Class A product, see page 527

Technical data		
Modbus/RTU		
D-SUB-9 socket		
1.2 kbps ... 115.2 kbps		
Inline data jumper		
Max. 61 (on board I/Os are two devices)		
24 V DC (via Inline connector)		
19.2 V DC ... 30 V DC (including all tolerances, including ripple)		
Max. 0.98 A (from U _{BK})		
Max. 0.8 A DC		
Max. 0.5 A DC		
2, 3-wire		
8 (EN 61131-2 type 1)		
approx. 500 µs		
Protection against polarity reversal		
2, 3-wire		
4		
500 mA		
Short-circuit and overload protection		
Spring-cage connection		
0.08 ... 1.5 mm ² / 0.08 ... 1.5 mm ² / 28 - 16		
80 mm / 119.8 mm / 71.5 mm		
-25 °C ... 60 °C		
Class A product, see page 527		

Ordering data

Type	Order No.	Pcs. / Pkt.
IL MOD BK D18 DO4-PAC	2878696	1

Accessories

IL BKDIO-PLSET	2878599	1
SUBCON-PLUS-MODBUS/IL/BK	2310808	1

Description	
Bus coupler , complete with accessories (connector plug and marking field)	
- for extended temperature range of -40°C ... +70°C	
Connector set for bus coupler	
D-SUB connector , 9-pos. with two cable entries, termination resistor can be switched on via slide switch	
Adapter cable , Inline field multiplexer on PSI-MOS module	



D-SUB connection



D-SUB connection,
8 digital inputs and 4 digital outputs



Field multiplexer,
copper connection

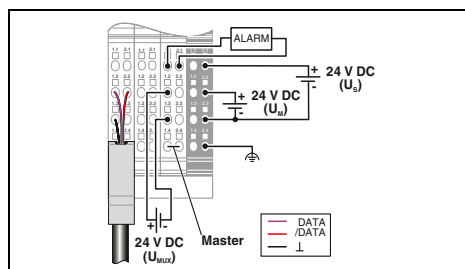
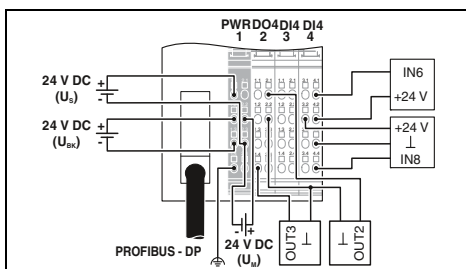
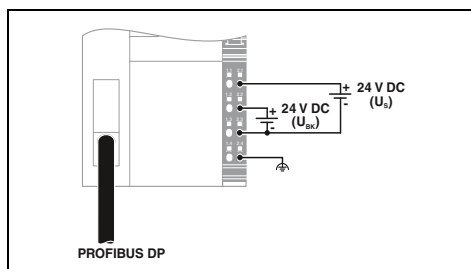

Technical data	
PROFIBUS DP	
D-SUB-9 socket	
9.6 kbps ... 12 Mbps	
Inline data jumper	
Max. 63	
24 V DC (via Inline connector)	
19.2 V DC ... 30 V DC (including all tolerances, including ripple)	
Max. 1.25 A	
Max. 2 A DC	
Max. 0.5 A DC	
-	
-	
-	
-	
Spring-cage connection	
0.08 ... 1.5 mm ² / 0.08 ... 1.5 mm ² / 28 - 16	
85 mm / 119.8 mm / 71.5 mm	
0 °C ... 55 °C	
Class A product, see page 527	

Technical data	
PROFIBUS DP	
D-SUB-9 socket	
9.6 kbps ... 12 Mbps	
Inline data jumper	
Max. 61 (on board I/Os are two devices)	
24 V DC (via Inline connector)	
19.2 V DC ... 30 V DC (including all tolerances, including ripple)	
Max. 0.98 A (from U _{BK})	
Max. 0.8 A DC	
Max. 0.5 A DC	
2, 3-wire	
8 (EN 61131-2 type 1)	
approx. 500 µs	
Protection against polarity reversal	
2, 3-wire	
4	
500 mA	
Short-circuit and overload protection	
Spring-cage connection	
0.08 ... 1.5 mm ² / 0.08 ... 1.5 mm ² / 28 - 16	
80 mm / 119.8 mm / 71.5 mm	
-25 °C ... 60 °C	
Class A product, see page 527	

Technical data	
RS-485	
Inline shield connector	
-	
Inline data jumper	
32 (without additional power terminal, observe permissible total current consumption)	
24 V DC (via Inline connector)	
19.2 V DC ... 30 V DC (including all tolerances, including ripple)	
Max. 1.25 A (with max. number of connected I/O terminal blocks)	
Max. 2 A DC (observe derating)	
Max. 0.5 A DC (observe derating)	
-	
-	
-	
-	
Spring-cage connection	
0.08 ... 1.5 mm ² / 0.08 ... 1.5 mm ² / 28 - 16	
48.8 mm / 135 mm / 71.5 mm	
-25 °C ... 55 °C	
Class A product, see page 527	

Ordering data		
Type	Order No.	Pcs. / Pkt.
IL PB BK DP/V1-PAC	2862246	1

Ordering data		
Type	Order No.	Pcs. / Pkt.
IL PB BK DI8 DO4/EF-PAC	2692322	1
IL PB BK DI8 DO4/EF-XC-PAC	2702132	1

Ordering data		
Type	Order No.	Pcs. / Pkt.
IB IL 24 MUX MA-PAC	2861205	1

Accessories		
IL BKDIO-PLSET	2878599	1
SUBCON-PLUS-PROFIB	2744348	1

Accessories		
IL BKDIO-PLSET	2878599	1
SUBCON-PLUS-PROFIB	2744348	1

Accessories		
IB IL MUX-CAB PSI	2878476	1

Power terminals

Inline power terminals are used to supply, protect, and diagnose the individual voltage routing within an Inline station.

Depending on the terminal type, various functions can be implemented.

Supply of:

- Main circuit (U_M) up to 8 A
- Segment circuit (U_S) for the I/O supply up to 8 A

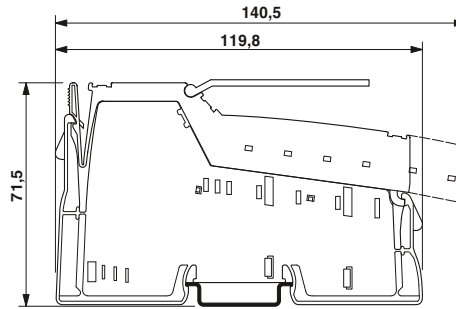

24 V

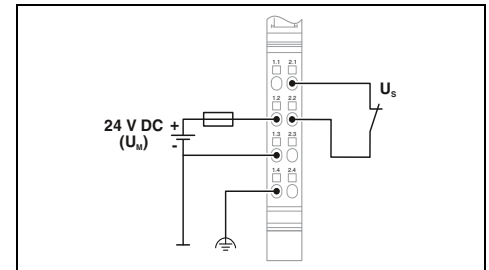

Technical data

Local bus interface	
Connection method	Inline data jumper
Power supply for module electronics	
Connection method	-
I/O voltage	-
I/O voltage range	-
Main circuit supply U_M	24 V DC
Power supply at U_M	8 A
Communications power U_L	7.5 V DC $\pm 5\%$ (via voltage jumper)
Power supply at U_L	-
Current consumption from U_L	-
I/O supply voltage U_{ANA}	-
Power supply at U_{ANA}	-
Segment supply voltage U_S	24 V DC
Power supply at U_S	8 A
Fuse	-
General data	
Connection method	Spring-cage connection
Connection data solid / stranded / AWG	0.08 ... 1.5 mm ² / 0.08 ... 1.5 mm ² / 28 - 16
Protective circuit	Surge protection, suppressor diode
Weight	59 g
Width	12.2 mm
Ambient temperature (operation)	-25 °C ... 55 °C

Ordering data

Type	Order No.	Pcs. / Pkt.
IB IL 24 PWR IN-PAC	2861331	1
IB IL 24 PWR IN-XC-PAC	2701161	1

Accessories

Inline distance terminal	
--------------------------	--

Boost terminal

The IB IL 24 PWR IN/R-PAC Inline boost terminal is used to boost the following voltages:

- Main circuit (U_M) up to 8 A
- Segment circuit (U_S) for the I/O supply up to 8 A
- Analog supply (U_{ANA}) up to 0.5 A
- Communications power (U_L) up to 2 A

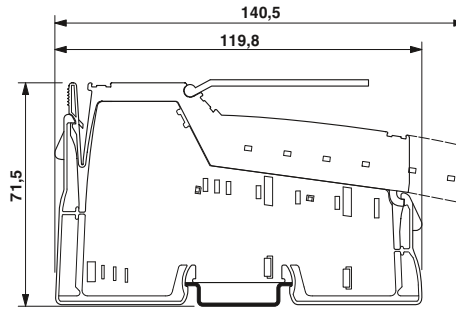

U_M, U_S, U_L, U_{ANA}

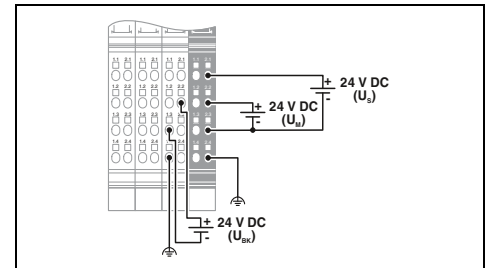

Technical data

Local bus interface	
Connection method	
Power supply for module electronics	
I/O voltage	
I/O voltage range	
Main circuit supply U_M	
Power supply at U_M	
Communications power U_L	
Power supply at U_L	
I/O supply voltage U_{ANA}	
Power supply at U_{ANA}	
Segment supply voltage U_S	
Power supply at U_S	
Fuse	
General data	
Connection method	
Connection data solid / stranded / AWG	
Protective circuit	
Weight	
Width	
Ambient temperature (operation)	

Inline data jumper	
24 V DC	
19.2 V DC ... 30 V DC (including all tolerances, including ripple)	
24 V DC	
8 A	
7.5 V DC $\pm 5\%$ (via voltage jumper)	
Max. 2 A DC	
24 V DC	
0.5 A DC	
24 V DC	
8 A DC	
Electrical/thermal overload protection, included in scope of delivery	
Spring-cage connection	
0.08 ... 1.5 mm ² / 0.08 ... 1.5 mm ² / 28 - 16	
Surge protection (segment supply, main supply, 24 V supply), input protective diodes (can be destroyed by permanent overload), pulse loads up to 1500 W are short circuited by the input protective diode.	
192 g	
48.8 mm	
-25 °C ... 55 °C	

Ordering data

Description	
Inline power terminal or boost terminal, complete with accessories (connector plug and marking field)	
- for extended temperature range of -40°C ... +70°C	

Type	Order No.	Pcs. / Pkt.
IB IL 24 PWR IN/R-PAC	2861674	1
IB IL 24 PWR IN/R-XC-PAC	2701298	1

Accessories

Connector set, for power terminal, color-coded	
--	--

IB IL PWR IN/R-PLSET	2860620	1
----------------------	---------	---

Boost terminal

The IB IL 24 PWR IN/R/L-0.8A-PAC Inline boost terminal is used to boost the following voltage:

- Communications power (U_L) up to 0.8 A

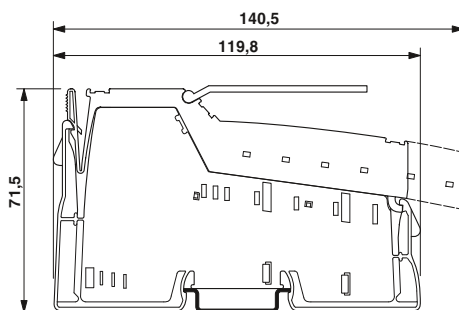

U_L

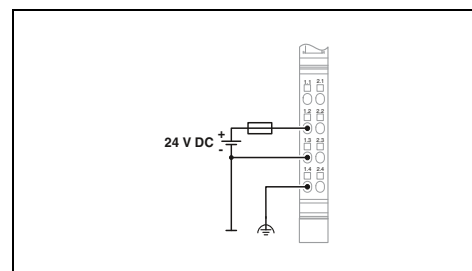

Local bus interface	
Connection method	
Power supply for module electronics	
I/O voltage	
I/O voltage range	
Communications power U_L	
Power supply at U_L	
Fuse	
General data	
Connection method	
Connection data solid / stranded / AWG	
Protective circuit	
Weight	65 g
Width	12.2 mm
Ambient temperature (operation)	-25 °C ... 55 °C

Technical data	
Inline data jumper	
24 V DC	
19.2 V DC ... 30 V DC (including all tolerances, including ripple)	
7.5 V DC $\pm 5\%$ (via voltage jumper)	
Max. 0.8 A DC	
Electrical/thermal overload protection, included in scope of delivery	
Spring-cage connection	
0.08 ... 1.5 mm ² / 0.08 ... 1.5 mm ² / 28 - 16	
Surge protection, input protective diodes (can be destroyed by permanent overload), pulse loads up to 1500 W are short circuited by the input protective diode.	

Description
Inline boost terminal , complete with accessories (connector plug and marking field)
- For communications power U_L of 0.8 A

Ordering data		
Type	Order No.	Pcs. / Pkt.
IB IL 24 PWR IN/R/L-0.8A-PAC	2693020	1

Connector plug for power and segment terminals
--

Accessories		
IB IL SCN-PWR IN-CP	2727637	10

Segment terminals

Inline segment terminals can be used to create several segment circuits (U_S) within the main circuit (U_M). The signal and initiator voltages for digital I/Os are always tapped from the segment circuit U_S .

Depending on the terminal type, various functions can be implemented:

- Segmentation without fuse
- Segmentation with fine fuse
- Segmentation with fine fuse and diagnostics
- Segmentation with electronic fuse and diagnostics

When combined with the IB IL PD 24V-PAC potential distributor terminal, 24 V supplies with electronic fuse protection and remote diagnostics can be provided in the field, for example. However, the potential distributor terminals are also suitable for the economical return wiring of sensor and actuator cables when using digital Inline terminals with the single-wire connection technology.

The IB IL DOR LV-SET-PAC distance terminal set creates the specified creepage distance when using AC terminals (gray housing). For example, when using IB IL 24/230 DOR 4/W-PAC relay terminals, the two end terminals interrupt all 24 V circuits as well as GND and functional earth ground.

AC power terminals for 120 V AC or 230 V AC already include distance terminals.

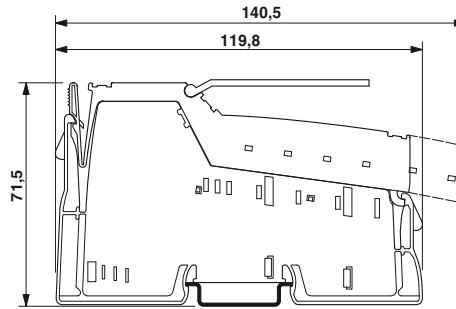

24 V

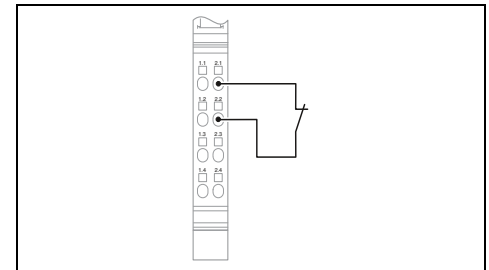

Technical data

Local bus interface	Inline data jumper
Connection method	Inline potential distributor
Power supply for module electronics	-
Connection method	-
Communications power U_L	24 V DC
Current consumption from U_L	8 A
Segment supply voltage U_S	-
Power supply at U_S	Spring-cage connection
Fuse	0.08 ... 1.5 mm ² / 0.08 ... 1.5 mm ² / 28 - 16
General data	Overload protection, fuse
Connection method	42 g
Connection data solid / stranded / AWG	12.2 mm
Protective circuit	-25 °C ... 55 °C
Weight	
Width	
Ambient temperature (operation)	

Ordering data

Description	Type	Order No.	Pcs. / Pkt.
Inline segment terminal , complete with accessories (connector plug and marking field)	IB IL 24 SEG-PAC	2861344	1
- With fuse			
- With fuse and diagnostics			
- For extended temperature range of -40°C ... +70°C			
Inline potential distributor terminal , complete with accessories (connector plug and marking field)			
- 24 V			
- GND			



24 V with fuse and diagnostics



24 V with electronic fuse



Potential distributor

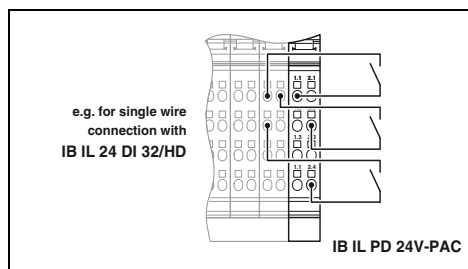
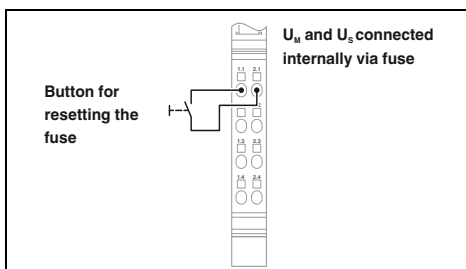
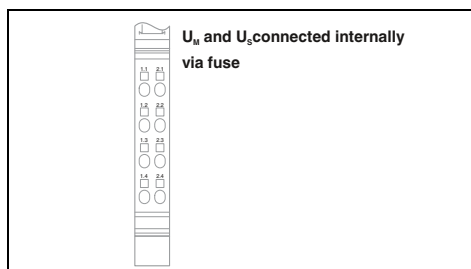

Technical data

Technical data

Technical data

Inline data jumper	-
Inline potential distributor	-
24 V DC	6 A
SI 5 x 20 6, 300 AT (in scope of delivery)	-
Spring-cage connection	0.08 ... 1.5 mm ² / 0.08 ... 1.5 mm ² / 28 - 16
Overload protection, fuse	59 g
	12.2 mm
	-25 °C ... 55 °C

Inline data jumper	-
Inline potential distributor	7.5 V DC (via voltage jumper)
	30 mA
	24 V DC
	2.5 A
	2.5 A (electronic)
Spring-cage connection	0.08 ... 1.5 mm ² / 0.08 ... 1.5 mm ² / 28 - 16
Overload protection	44 g
	12.2 mm
	-25 °C ... 55 °C

IB IL PD 24V-PAC	IB IL PD GND-PAC
Inline data jumper	
Inline potential distributor	-
24 V DC	-
	-
Spring-cage connection	0.08 ... 1.5 mm ² / 0.08 ... 1.5 mm ² / 28 - 16
	-
	44 g
	12.2 mm
	-25 °C ... 55 °C

Ordering data

Ordering data

Ordering data

Type	Order No.	Pcs. / Pkt.
IB IL 24 SEG/F-PAC	2861373	1
IB IL 24 SEG/F-D-PAC	2861904	1
IB IL 24 SEG/F-XC-PAC	2701163	1

Type	Order No.	Pcs. / Pkt.
IB IL 24 SEG-ELF-PAC	2861409	1

Type	Order No.	Pcs. / Pkt.
IB IL PD 24V-PAC	2862987	1
IB IL PD GND-PAC	2862990	1

Digital input terminals

Digital Inline input terminals are designed to connect digital signals, such as those supplied by buttons, limit switches or proximity switches.

Features, depending on the selected device:

- 2- to 32-channel
- According to EN 61131-2 Type 1 or 3
- Single-, 2-, 3- or 4-wire connection technology
- Maximum permissible load current per sensor: 250 mA



2 inputs



4 inputs

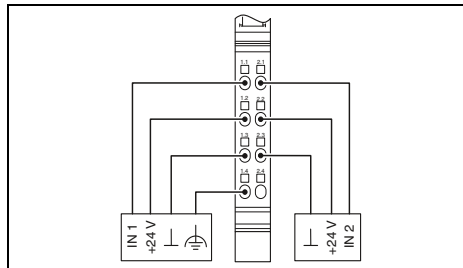

Technical data

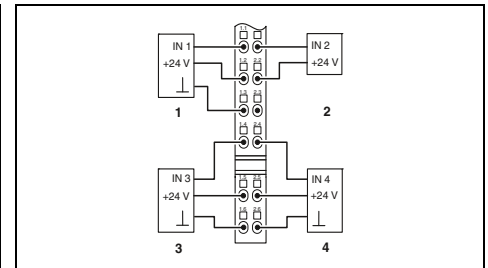

Technical data

Local bus interface	
Connection method	Inline data jumper
Power supply for module electronics	
Supply voltage	24 V DC (via voltage jumper)
Supply voltage range	19.2 V DC ... 30 V DC (including all tolerances, including ripple)
Current consumption from U _L	Max. 35 mA
Digital inputs	
Connection method	Spring-cage connection
Connection technology	2, 3, 4-wire
Number of inputs	2 (EN 61131-2 type 1)
Typical response time	< 1 ms
General data	
Connection method	Spring-cage connection
Connection data solid / stranded / AWG	0.08 ... 1.5 mm ² / 0.08 ... 1.5 mm ² / 28 - 16
Weight	53 g
Dimensions	12.2 mm / 119.8 mm / 71.5 mm
Ambient temperature (operation)	-25 °C ... 55 °C
EMC note	Class A product, see page 527

Local bus interface	
Connection method	Inline data jumper
Power supply for module electronics	
Supply voltage	24 V DC (via voltage jumper)
Supply voltage range	19.2 V DC ... 30 V DC (including all tolerances, including ripple)
Current consumption from U _L	Max. 40 mA
Digital inputs	
Connection method	Spring-cage connection
Connection technology	2, 3-wire
Number of inputs	4 (EN 61131-2 type 1)
Typical response time	< 1 ms
General data	
Connection method	Spring-cage connection
Connection data solid / stranded / AWG	0.08 ... 1.5 mm ² / 0.08 ... 1.5 mm ² / 28 - 16
Weight	66 g
Dimensions	12.2 mm / 140.5 mm / 71.5 mm
Ambient temperature (operation)	-25 °C ... 55 °C
EMC note	Class A product, see page 527

Description	
Inline digital input terminal , complete with accessories (connector plug and marking field)	
- Single-wire connection technology	
- For extended temperature range of -40°C ... +70°C	

Ordering data		
Type	Order No.	Pcs. / Pkt.
IB IL 24 DI 2-PAC	2861221	1

Ordering data		
Type	Order No.	Pcs. / Pkt.
IB IL 24 DI 4-PAC	2861234	1
IB IL 24 DI 4-XC-PAC	2701152	1

Connector set for IB IL DI/DO 8	
Connector set for IB IL DI 16, color-coded	
Inline connector	

Accessories		
Type	Order No.	Pcs. / Pkt.
IB IL SCN-8-CP	2727608	10

Accessories		
Type	Order No.	Pcs. / Pkt.
IB IL SCN-12-ICP	2727611	10



8 inputs



16 inputs



32 inputs

UL US ENEC ABS BSH CE RoHS Ex:

UL US ENEC ABS BSH CE RoHS Ex:

UL US ENEC ABS BSH CE RoHS Ex:

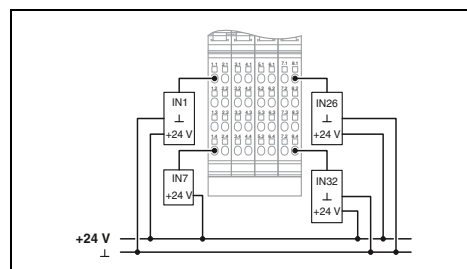
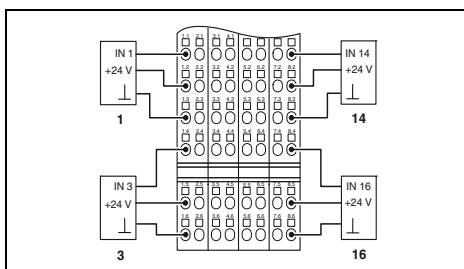
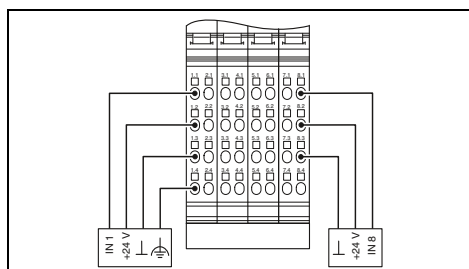

Technical data

IB IL 24 DI 8-PAC IB IL 24 DI8/HD-PAC

Inline data jumper

24 V DC (via voltage jumper)

19.2 V DC ... 30 V DC (including all tolerances, including ripple)

Max. 50 mA

Max. 30 mA DC

Spring-cage connection

2, 3, 4-wire

1-wire

8 (EN 61131-2 type 1)

8 (EN 61131-2 types 1 and 3)

< 1 ms

1 ms

Spring-cage connection

0.08 ... 1.5 mm² / 0.08 ... 1.5 mm² / 28 - 16

118 g

60 g

48.8 mm / 119.8 mm / 71.5 mm

12.2 mm / 119.8 mm / 71.5 mm

-25 °C ... 55 °C

Class A product, see page 527

Technical data

Inline data jumper

24 V DC (via voltage jumper)

19.2 V DC ... 30 V DC (including all tolerances, including ripple)

Max. 60 mA

Spring-cage connection

2, 3-wire

16 (EN 61131-2 type 1)

< 1 ms

Spring-cage connection

0.08 ... 1.5 mm² / 0.08 ... 1.5 mm² / 28 - 16

210 g

48.8 mm / 140.5 mm / 71.5 mm

-25 °C ... 55 °C

Class A product, see page 527

Technical data

Inline data jumper

24 V DC (via voltage jumper)

19.2 V DC ... 30 V DC (including all tolerances, including ripple)

Max. 90 mA

Spring-cage connection

1-wire

32 (EN 61131-2 type 1)

2 ms

Spring-cage connection

0.08 ... 1.5 mm² / 0.08 ... 1.5 mm² / 28 - 16

185 g

48.8 mm / 119.8 mm / 71.5 mm

-25 °C ... 55 °C

Class A product, see page 527

Ordering data

Type	Order No.	Pcs. / Pkt.
IB IL 24 DI 8-PAC	2861247	1
IB IL 24 DI8/HD-PAC	2700173	1
IB IL 24 DI8/HD-XC-PAC	2701212	1

Ordering data

Type	Order No.	Pcs. / Pkt.
IB IL 24 DI 16-PAC	2861250	1
IB IL 24 DI 16-XC-PAC	2701154	1

Ordering data

Type	Order No.	Pcs. / Pkt.
IB IL 24 DI 32/HD-PAC	2862835	1

Accessories

IB IL DI/DO 8-PLSET/CP	2860963	1
IB IL SCN-8	2726337	10

Accessories

IB IL DI16-PLSET/ICP	2860989	1
----------------------	---------	---

Accessories

IB IL DI/DO 8-PLSET	2860950	1
---------------------	---------	---

For the control cabinet (IP20) – Inline

Digital input terminals

The digital Inline input terminals are used to acquire digital input signals. They are designed for use within an Inline station.

NPN terminal features:

- 2- to 32-channel

T2 terminal features:

- According to EN 61131-2 Type 2

S0 terminal features:

- Connection of S0 pulse encoders
- 32-bit counter range

Pulse counter:

- Maximum counting frequency of up to 150 Hz

Operating hours counter:

- 1 s resolution
- Counter enabled on active or inactive input (configurable)



2 inputs, NPN-wired



16 inputs, NPN-wired

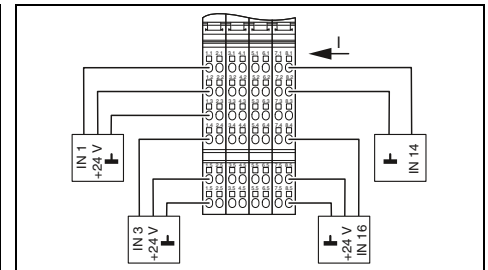
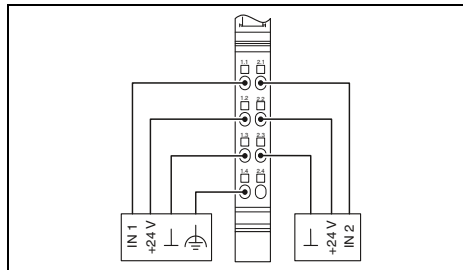

Technical data

Technical data

Local bus interface	
Connection method	
Power supply for module electronics	
Supply voltage	
Supply voltage range	
Current consumption from U _L	
Digital inputs	
Connection method	
Connection technology	
Number of inputs	
Description of the inputs	
Typical response time	
General data	
Connection method	
Connection data solid / stranded / AWG	
Weight	
Dimensions	W / H / D
Ambient temperature (operation)	
EMC note	

Inline data jumper	
24 V DC (via voltage jumper)	
19.2 V DC ... 30 V DC (including all tolerances, including ripple)	
Max. 35 mA	
Spring-cage connection	
2, 3, 4-wire	
2 (EN 61131-2 type 1)	
-	
< 1 ms	
Spring-cage connection	
0.08 ... 1.5 mm ² / 0.08 ... 1.5 mm ² / 28 - 16	
53 g	
12.2 mm / 119.8 mm / 71.5 mm	
-25 °C ... 55 °C	
Class A product, see page 527	

Inline data jumper	
24 V DC (via voltage jumper)	
19.2 V DC ... 30 V DC (including all tolerances, including ripple)	
Max. 60 mA	
Spring-cage connection	
2, 3-wire	
16 (EN 61131-2 type 1)	
-	
< 1 ms	
Spring-cage connection	
0.08 ... 1.5 mm ² / 0.08 ... 1.5 mm ² / 28 - 16	
122 g	
48.8 mm / 140.5 mm / 71.5 mm	
-25 °C ... 55 °C	
Class A product, see page 527	

Ordering data

Ordering data

Description	
Inline digital input terminal , complete with accessories (connector plug and marking field)	
- NPN-wired	
- Input according to EN 61131-2/Type 2	
- S0 counter	

Type	Order No.	Pcs. / Pkt.
IB IL 24 DI 2-NPN-PAC	2861483	1

Type	Order No.	Pcs. / Pkt.
IB IL 24 DI 16-NPN-PAC	2863520	1

Accessories

Accessories

Connector set for IB IL DI/DO 8	
Inline connector	

IB IL SCN-8-CP	2727608	10
-----------------------	----------------	----

IB IL SCN-12-ICP	2727611	10
-------------------------	----------------	----



32 inputs, NPN-wired



8 inputs, EN 61131-2/Type 2



8 S₀ counter inputs

UL ABS CE Ex: Ex

UL Ex: Ex

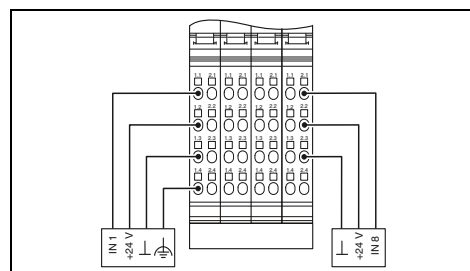
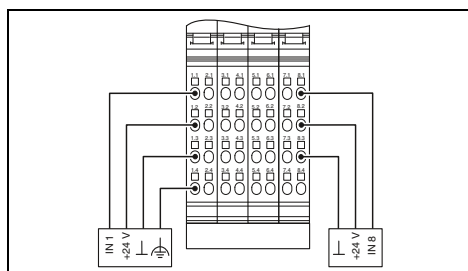
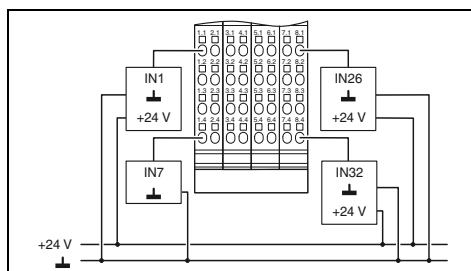

Technical data	
Inline data jumper	
24 V DC (via voltage jumper) 19.2 V DC ... 30 V DC (including all tolerances, including ripple)	
Max. 90 mA	
Spring-cage connection 1-wire 32 (EN 61131-2 type 1)	
< 1 ms	
Spring-cage connection 0.08 ... 1.5 mm ² / 0.08 ... 1.5 mm ² / 28 - 16 125 g 48.8 mm / 119.8 mm / 71.5 mm -25 °C ... 55 °C Class A product, see page 527	

Technical data	
Inline data jumper	
24 V DC (via voltage jumper) 19.2 V DC ... 30 V DC (including all tolerances, including ripple)	
Max. 50 mA	
Spring-cage connection 2, 3, 4-wire 8 (IEC 61131-2 type 2)	
< 1 ms	
Spring-cage connection 0.08 ... 1.5 mm ² / 0.08 ... 1.5 mm ² / 28 - 16 118 g 48.8 mm / 119.8 mm / 71.5 mm -25 °C ... 55 °C Class A product, see page 527	

Technical data	
Inline data jumper	
24 V DC (via voltage jumper) 19.2 V DC ... 30 V DC	
Max. 50 mA	
Spring-cage connection 2, 3, 4-wire 8 According to DIN 43864	
< 1 ms	
Spring-cage connection 0.08 ... 1.5 mm ² / 0.08 ... 1.5 mm ² / 28 - 16 118 g 48.8 mm / 119.8 mm / 71.5 mm -25 °C ... 55 °C Class A product, see page 527	

Ordering data		
Type	Order No.	Pcs. / Pkt.
IB IL 24 DI 32/HD-NPN-PAC	2878243	1

Ordering data		
Type	Order No.	Pcs. / Pkt.
IB IL 24 DI 8/T2-PAC	2862204	1

Ordering data		
Type	Order No.	Pcs. / Pkt.
IB IL DI 8/S0-PAC	2897020	1

Accessories		
Type	Order No.	Pcs. / Pkt.
IB IL DI/DO 8-PLSET	2860950	1

Accessories		
Type	Order No.	Pcs. / Pkt.
IB IL DI/DO 8-PLSET/CP	2860963	1

Accessories		
Type	Order No.	Pcs. / Pkt.
IB IL SCN-8-CP	2727608	10

Digital input terminals

The terminals are designed for use within an Inline station. They are used to acquire digital input signals in the 120 V AC or 230 V AC voltage range.

Features:

- Connections for one digital sensor
- Maximum permissible load current: 500 mA

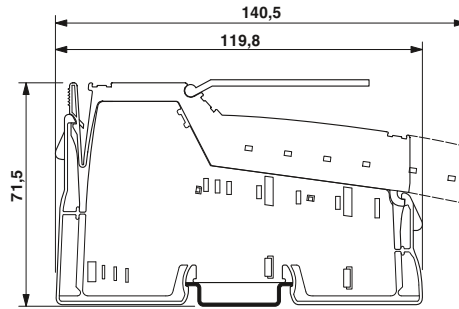

1 input, 120 V

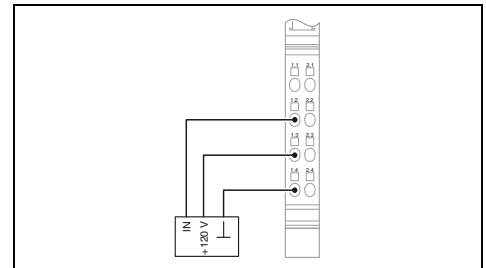

Local bus interface	
Connection method	
Power supply for module electronics	
Supply voltage	120 V AC (via voltage jumper)
Supply voltage range	108 V AC ... 135 V AC
Current consumption from U_L	Max. 30 mA
Digital inputs	
Connection method	Spring-cage connection
Connection technology	2, 3-wire
Number of inputs	1 (EN 61131-2 type 1)
General data	
Connection method	Spring-cage connection
Connection data solid / stranded / AWG	0.08 ... 1.5 mm ² / 0.08 ... 1.5 mm ² / 28 - 16
Weight	39 g
Width	12.2 mm
Ambient temperature (operation)	-25 °C ... 55 °C
EMC note	Class A product, see page 527

Technical data

Inline data jumper		
120 V AC (via voltage jumper)		
108 V AC ... 135 V AC		
Max. 30 mA		
Spring-cage connection		
2, 3-wire		
1 (EN 61131-2 type 1)		
Spring-cage connection		
0.08 ... 1.5 mm ² / 0.08 ... 1.5 mm ² / 28 - 16		
39 g		
12.2 mm		
-25 °C ... 55 °C		
Class A product, see page 527		

Description	
Inline digital input terminal , complete with accessories (connector plug and marking field)	
- 120 V AC	
- 230 V AC	

Ordering data

Type	Order No.	Pcs. / Pkt.
IB IL 120 DI 1-PAC	2861917	1

Inline distance terminal	
Connector for Inline input terminals with AC voltage, color-coded	

Accessories

IB IL DOR LV-SET-PAC	2861645	1
IB IL SCN-8-AC-ICP	2740261	10



1 input, 230 V

UL and ENEC certification logos.

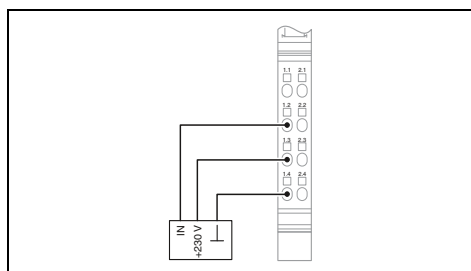

Technical data

Inline data jumper

230 V AC (via voltage jumper)
12 V AC ... 253 V AC
Max. 30 mA

Spring-cage connection
2, 3-wire
1 (EN 61131-2 type 1)

Spring-cage connection
0.08 ... 1.5 mm² / 0.08 ... 1.5 mm² / 28 - 16
39 g
12.2 mm
-25 °C ... 55 °C
Class A product, see page 527

Ordering data

Type	Order No.	Pcs. / Pkt.
IB IL 230 DI 1-PAC	2861548	1

Accessories

IB IL DOR LV-SET-PAC	2861645	1
IB IL SCN-8-AC-ICP	2740261	10

Digital output terminals

Digital Inline output terminals are designed for the connection of digital actuators, such as electromagnetic valves, contactors or visual indicators.

Features, depending on the selected device:

- 2- to 32-channel
- Connection of actuators in single-, 2-, 3-, and 4-wire technology
- Nominal current per output: 500 mA
- Short-circuit and overload protected outputs



2 outputs



4 outputs

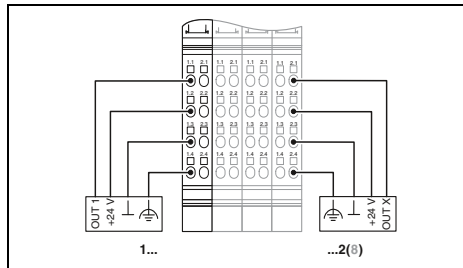

Technical data

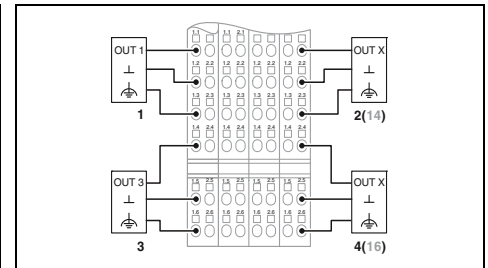

Technical data

Local bus interface	
Connection method	Inline data jumper
Power supply for module electronics	
Supply voltage	24 V DC (via voltage jumper)
Supply voltage range	19.2 V DC ... 30 V DC (including all tolerances, including ripple)
Current consumption from U _L	Max. 33 mA
Digital outputs	
Connection technology	2, 3, 4-wire
Maximum number of outputs	2
Maximum output current per channel	500 mA
Protective circuit	Overload protection, short-circuit protection of outputs
General data	
Connection method	Spring-cage connection
Connection data solid / stranded / AWG	0.08 ... 1.5 mm ² / 0.08 ... 1.5 mm ² / 28 - 16
Weight	41 g
Dimensions	12.2 mm / 119.8 mm / 71.5 mm
Ambient temperature (operation)	-25 °C ... 55 °C
EMC note	Class A product, see page 527

Local bus interface	
Connection method	Inline data jumper
Power supply for module electronics	
Supply voltage	24 V DC (via voltage jumper)
Supply voltage range	19.2 V DC ... 30 V DC (including all tolerances, including ripple)
Current consumption from U _L	Max. 44 mA
Digital outputs	
Connection technology	2, 3-wire
Maximum number of outputs	4
Maximum output current per channel	500 mA
Protective circuit	Overload protection, short-circuit protection of outputs
General data	
Connection method	Spring-cage connection
Connection data solid / stranded / AWG	0.08 ... 1.5 mm ² / 0.08 ... 1.5 mm ² / 28 - 16
Weight	66 g
Dimensions	12.2 mm / 140.5 mm / 71.5 mm
Ambient temperature (operation)	-25 °C ... 55 °C
EMC note	Class A product, see page 527

Description	Inline digital output terminal , complete with accessories (connector plug and marking field)
	- Single-wire connection technology - For extended temperature range of -40°C ... +70°C

Ordering data		
Type	Order No.	Pcs. / Pkt.
IB IL 24 DO 2-PAC	2861470	1

Ordering data		
Type	Order No.	Pcs. / Pkt.
IB IL 24 DO 4-PAC	2861276	1
IB IL 24 DO 4-XC-PAC	2701155	1

Connector set for IB IL DI/DO 8	
Inline connector	

Accessories		
Type	Order No.	Pcs. / Pkt.
IB IL SCN-8-CP	2727608	10

Accessories		
Type	Order No.	Pcs. / Pkt.
IB IL SCN-12-OC	2727624	10



8 outputs

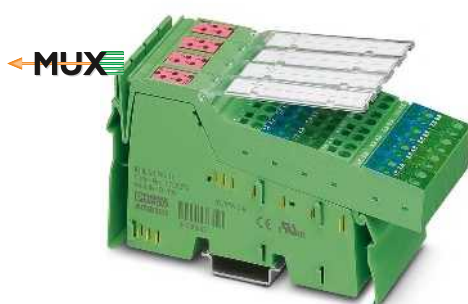

16 outputs



32 outputs

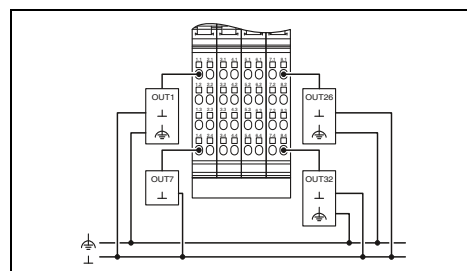
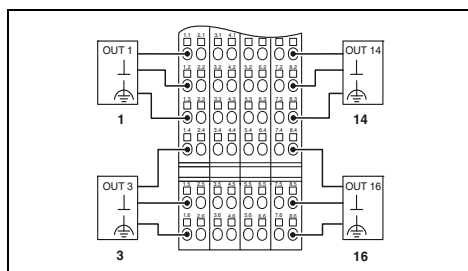
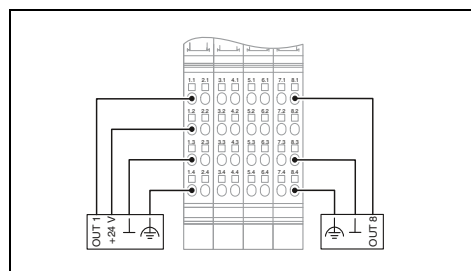

Technical data

Technical data

Technical data

IB IL 24 DO 8-PAC	IB IL 24 DO8/HD-PAC
Inline data jumper	
24 V DC (via voltage jumper)	
19.2 V DC ... 30 V DC (including all tolerances, including ripple)	
Max. 60 mA	Max. 45 mA
2, 3, 4-wire	1-wire
	8
	500 mA
Overload protection, short-circuit protection of outputs	
Spring-cage connection	
0.08 ... 1.5 mm ² / 0.08 ... 1.5 mm ² / 28 - 16	
130 g	60 g
48.8 mm / 119.8 mm / 71.5 mm	12.2 mm / 119.8 mm / 71.5 mm
-25 °C ... 55 °C	
Class A product, see page 527	

IB IL 24 DO 16-PAC	
Inline data jumper	
24 V DC (via voltage jumper)	
19.2 V DC ... 30 V DC (including all tolerances, including ripple)	
Max. 90 mA	
2, 3-wire	
16	
500 mA	
Overload protection, short-circuit protection of outputs	
Spring-cage connection	
0.08 ... 1.5 mm ² / 0.08 ... 1.5 mm ² / 28 - 16	
218 g	
48.8 mm / 140.5 mm / 71.5 mm	
-25 °C ... 55 °C	
Class A product, see page 527	

IB IL 24 DO 32-PAC	
Inline data jumper	
24 V DC (via voltage jumper)	
19.2 V DC ... 30 V DC (including all tolerances, including ripple)	
Max. 140 mA	
1-wire	
32	
500 mA	
Overload protection, short-circuit protection of outputs	
Spring-cage connection	
0.08 ... 1.5 mm ² / 0.08 ... 1.5 mm ² / 28 - 16	
195 g	
48.8 mm / 119.8 mm / 71.5 mm	
-25 °C ... 55 °C	
Class A product, see page 527	

Ordering data

Ordering data

Ordering data

Type	Order No.	Pcs. / Pkt.
IB IL 24 DO 8-PAC	2861289	1
IB IL 24 DO8/HD-PAC	2700172	1
IB IL 24 DO8/HD-XC-PAC	2701213	1

Type	Order No.	Pcs. / Pkt.
IB IL 24 DO 16-PAC	2861292	1
IB IL 24 DO 16-XC-PAC	2701156	1

Type	Order No.	Pcs. / Pkt.
IB IL 24 DO 32/HD-PAC	2862822	1

Accessories

Accessories

Accessories

IB IL DI/DO 8-PLSET/CP	2860963	1
IB IL SCN-8	2726337	10

IB IL DO16-PLSET/OCP	2860992	1
----------------------	---------	---

IB IL DI/DO 8-PLSET	2860950	1
---------------------	---------	---

Digital output terminals

The terminals are designed for use within an Inline station. They are used to output digital signals.

NPN terminal features:

- NPN-wired
- 2- to 32-channel
- Connection of sensors in single-, 2-, 3-, and 4-wire technology
- Maximum permissible load current per actuator: 500 mA
- Short-circuit and overload protected outputs

2 A module features:

- 2- to 8-channel
- Connection of sensors in 2-, 3-, and 4-wire technology
- Maximum permissible load current per actuator: 2 A
- Short-circuit and overload protected outputs



2 outputs, NPN-wired



8 outputs, NPN-wired

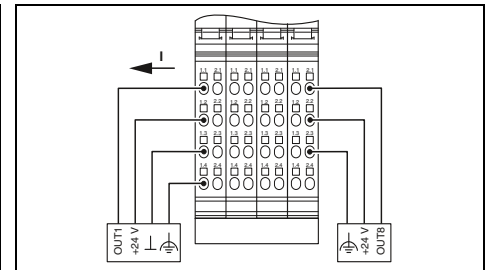
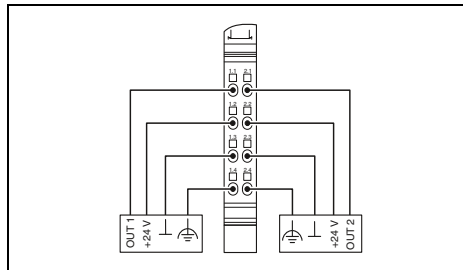

Technical data

Technical data

Local bus interface	
Connection method	Inline data jumper
Power supply for module electronics	
Supply voltage	24 V DC (via voltage jumper)
Supply voltage range	19.2 V DC ... 30 V DC (including all tolerances, including ripple)
Current consumption from U _I	Max. 32 mA
Digital outputs	
Connection technology	2, 3, 4-wire
Maximum number of outputs	2
Maximum output current per channel	500 mA
Protective circuit	Overload protection, short-circuit protection of outputs
General data	
Connection method	Spring-cage connection
Connection data solid / stranded / AWG	0.08 ... 1.5 mm ² / 0.08 ... 1.5 mm ² / 28 - 16
Weight	42 g
Dimensions	W / H / D 12.2 mm / 119.8 mm / 71.5 mm
Ambient temperature (operation)	-25 °C ... 55 °C
EMC note	Class A product, see page 527

Local bus interface	
Connection method	Inline data jumper
Power supply for module electronics	
Supply voltage	24 V DC (via voltage jumper)
Supply voltage range	19.2 V DC ... 30 V DC (including all tolerances, including ripple)
Current consumption from U _I	Max. 60 mA
Digital outputs	
Connection technology	2, 3, 4-wire
Maximum number of outputs	8
Maximum output current per channel	1 A
Protective circuit	Overload protection, short-circuit protection of outputs
General data	
Connection method	Spring-cage connection
Connection data solid / stranded / AWG	0.08 ... 1.5 mm ² / 0.08 ... 1.5 mm ² / 28 - 16
Weight	130 g
Dimensions	W / H / D 48.8 mm / 119.5 mm / 71.5 mm
Ambient temperature (operation)	-25 °C ... 55 °C
EMC note	Class A product, see page 527

Ordering data

Ordering data

Description	
Inline digital output terminal , complete with accessories (connector plug and marking field)	
- NPN-wired	
- Outputs 2 A	
- For extended temperature range of -40°C ... +70°C	

Type	Order No.	Pcs. / Pkt.
IB IL 24 DO 2-NPN-PAC	2861496	1

Type	Order No.	Pcs. / Pkt.
IB IL 24 DO 8-NPN-PAC	2863546	1

Accessories

Accessories

Connector set for IB IL DI/DO 8	
Inline connector	

IB IL SCN-8-CP	2727608	10
----------------	---------	----

IB IL DI/DO 8-PLSET/CP	2860963	1
------------------------	---------	---



32 outputs, NPN-wired



2 outputs, 2 A



8 outputs, 2 A

UL US ABS CE Ex: Ex

UL US ERG Ex: Ex

UL US ERG

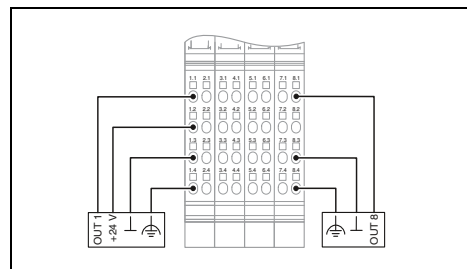
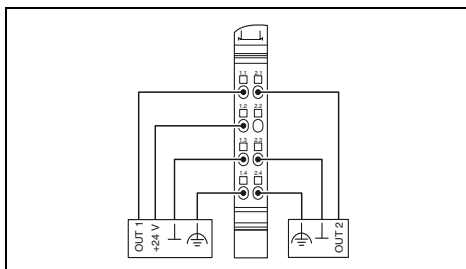
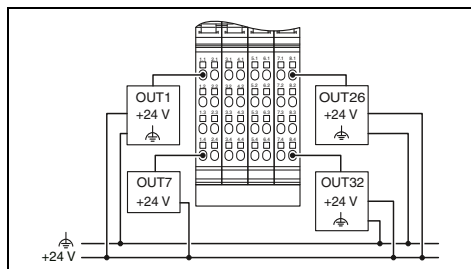

Technical data

Technical data

Technical data

Inline data jumper
 24 V DC (via voltage jumper)
 19.2 V DC ... 30 V DC (including all tolerances, including ripple)
 Max. 140 mA
 1-wire
 32
 500 mA
 Overload protection, short-circuit protection of outputs

Inline data jumper
 24 V DC (via voltage jumper)
 19.2 V DC ... 30 V DC (including all tolerances, including ripple)
 Max. 35 mA
 2, 3, 4-wire
 2
 2 A
 Overload protection, short-circuit protection of outputs

Inline data jumper
 24 V DC (via voltage jumper)
 19.2 V DC ... 30 V DC (including all tolerances, including ripple)
 Max. 60 mA
 2, 3, 4-wire
 8
 2 A
 Overload protection, short-circuit protection of outputs

Spring-cage connection
 0.08 ... 1.5 mm² / 0.08 ... 1.5 mm² / 28 - 16
 135 g
 48.8 mm / 119.8 mm / 71.5 mm
 -25 °C ... 55 °C
 Class A product, see page 527

Spring-cage connection
 0.08 ... 1.5 mm² / 0.08 ... 1.5 mm² / 28 - 16
 61 g
 12.2 mm / 119.8 mm / 71.5 mm
 -25 °C ... 55 °C
 Class A product, see page 527

Spring-cage connection
 0.08 ... 1.5 mm² / 0.08 ... 1.5 mm² / 28 - 16
 130 g
 48.8 mm / 119.8 mm / 71.5 mm
 -25 °C ... 55 °C
 Class A product, see page 527

Ordering data

Ordering data

Ordering data

Type	Order No.	Pcs. / Pkt.
IB IL 24 DO 32/HD-NPN-PAC	2878340	1

Type	Order No.	Pcs. / Pkt.
IB IL 24 DO 2-2A-PAC	2861263	1
IB IL 24 DO 2-2A-XC-PAC	2702133	1

Type	Order No.	Pcs. / Pkt.
IB IL 24 DO 8-2A-PAC	2861603	1

Accessories

Accessories

Accessories

IB IL DI/DO 8-PLSET	2860950	1
---------------------	---------	---

IB IL SCN-8-CP	2727608	10
----------------	---------	----

IB IL DI/DO 8-PLSET/CP	2860963	1
------------------------	---------	---

Digital output terminals

Digital Inline output terminals are designed for the connection of digital actuators, such as electromagnetic valves, contactors or visual indicators.

Inline relay terminals make it possible to switch any I/O voltage up to a maximum of 230 V AC.

Differing relay contact materials ensure low contact resistance for small loads and lamp loads in the ...W versions, while the ...W/PC versions are designed for capacitive loads.

The IB IL 24/48 DOR 2/W-PAC module is a relay module for small signals.

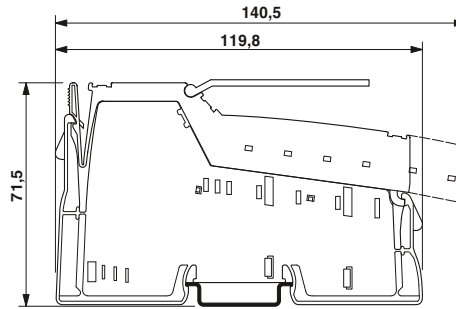

1/4 outputs, 12 - 253 V AC

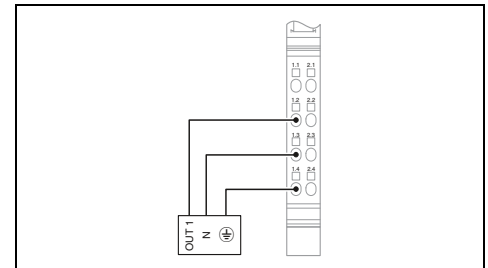

Local bus interface
Connection method
Power supply for module electronics
Supply voltage
Supply voltage range
Current consumption from U _L
Digital outputs
Connection method
Connection technology
Maximum number of outputs
Maximum output current per channel
General data
Connection method
Connection data solid / stranded / AWG
Weight
Width
Ambient temperature (operation)
EMC note

Technical data	
IB IL DO 1 AC-PAC	IB IL DO 4 AC-1A-PAC
Inline data jumper	
24 V DC (nominal value)	
19.2 V DC ... 30 V DC (including all tolerances, including ripple)	
Max. 35 mA	Max. 45 mA
Spring-cage connection	
3-wire	
1	4
500 mA	1 A
Spring-cage connection	
0.08 ... 1.5 mm ² / 0.08 ... 1.5 mm ² / 28 - 16	
45 g	130 g
12.2 mm	48.8 mm
-25 °C ... 55 °C	
Class A product, see page 527	

Description
Inline digital output terminal , complete with accessories (connector plug and marking field)
- 1 output
- 4 outputs 1 A
- 1 SPDT relay contact
- 2 SPDT relay contacts
- 4 SPDT relay contacts
- 4 SPDT relay contacts, 10 A, high inrush current
- for extended temperature range of -40°C ... +70°C

Ordering data		
Type	Order No.	Pcs. / Pkt.
IB IL DO 1 AC-PAC	2861920	1
IB IL DO 4 AC-1A-PAC	2861658	1

Inline distance terminal
Connector for digital Inline output terminals, color-coded
Connector for digital Inline terminals with AC voltage

Accessories		
Type	Order No.	Pcs. / Pkt.
IB IL DOR LV-SET-PAC	2861645	1
IB IL SCN-8-AC-OCP	2740274	10



1/4 relay outputs, 5 - 253 V AC, gold contacts



1/4 relay outputs, 5 - 253 V AC



2 relay outputs, 5 - 50 V AC, 5 - 120 V DC

UL US ENEC ABS BSH Ex:

UL US ENEC

ABS

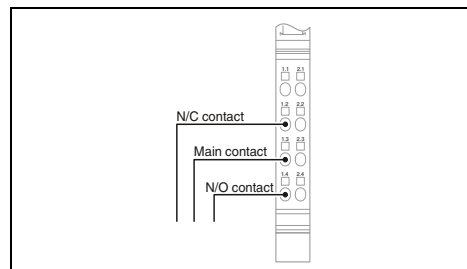
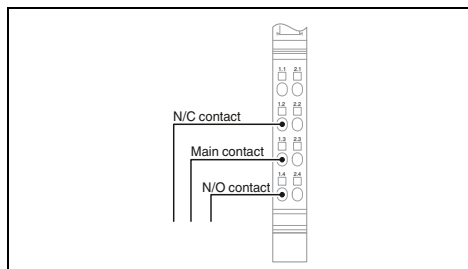
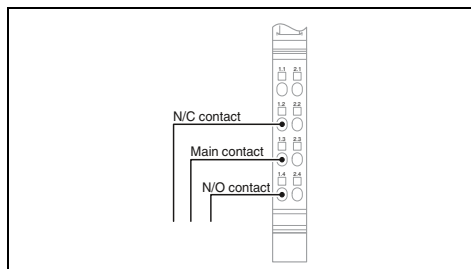

Technical data	
IB IL 24/230 DOR1/W-PAC	IB IL 24/230 DOR4/W-PC-PAC
Inline data jumper	
24 V DC (nominal value)	
19.2 V DC ... 30 V DC (including all tolerances, including ripple)	
Max. 60 mA	Max. 187 mA
Spring-cage connection	
Floating SPDT relay contact	
1	4
3 A	
Spring-cage connection	
0.08 ... 1.5 mm ² / 0.08 ... 1.5 mm ² / 28 - 16	
46 g	138 g
12.2 mm	48.8 mm
-25 °C ... 55 °C	
Class A product, see page 527	

Technical data	
IB IL 24/230 DOR1/W-PC-PAC	IB IL 24/230 DOR4/W-PC-PAC
Inline data jumper	Via data marshalling
24 V DC (nominal value)	
19.2 V DC ... 30 V DC (including all tolerances, including ripple)	
Max. 60 mA	Max. 187 mA
Spring-cage connection	
Floating SPDT relay contact	
1	4
2.6 A	
Spring-cage connection	
0.08 ... 1.5 mm ² / 0.08 ... 1.5 mm ² / 28 - 16	
46 g	138 g
12.2 mm	48.8 mm
-25 °C ... 55 °C	
Class A product, see page 527	

Technical data	
Inline data jumper	
24 V DC (nominal value)	
19.2 V DC ... 30 V DC (including all tolerances, including ripple)	
Max. 30 mA	
Spring-cage connection	
-	
2	2 A
Spring-cage connection	
0.08 ... 1.5 mm ² / 0.08 ... 1.5 mm ² / 28 - 16	
63 g	
12.2 mm	
-25 °C ... 55 °C	
Class A product, see page 527	

Ordering data		
Type	Order No.	Pcs. / Pkt.
IB IL 24/230 DOR1/W-PAC	2861881	1
IB IL 24/230 DOR4/W-PAC	2861878	1
IB IL 24/230 DOR4/HC-PAC	2897716	1

Ordering data		
Type	Order No.	Pcs. / Pkt.
IB IL 24/230 DOR1/W-PC-PAC	2862178	1
IB IL 24/230 DOR4/W-PC-PAC	2862181	1

Ordering data		
Type	Order No.	Pcs. / Pkt.
IB IL 24/48 DOR 2/W-PAC	2863119	1
IB IL 24/48 DOR 2/W-XC-PAC	2701214	1

Accessories		
IB IL DOR LV-SET-PAC	2861645	1
IB IL SCN-8-AC-REL	2740290	10

Accessories		
IB IL DOR LV-SET-PAC	2861645	1
IB IL SCN-8-AC-REL	2740290	10

Accessories		

Analog input terminals

Inline analog input terminals are suitable for connecting standard sensors for acquiring current and voltage signals.

Terminals with 2, 4 or 8 channels are available.

Features:

- Single-ended and differential inputs
- Connection of sensors in 2- or 3-wire technology
- Measured value acquisition with 13- or 16-bit resolution
- High level of measuring accuracy
- Excellent interference and common mode suppression
- Overload-protected current inputs
- Integrated short-circuit-proof sensor supply

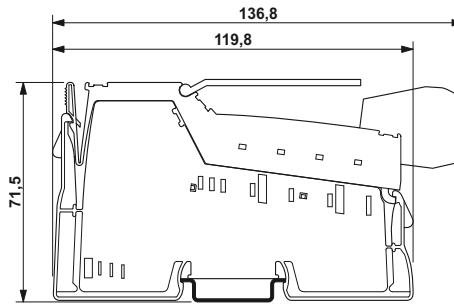

2 inputs

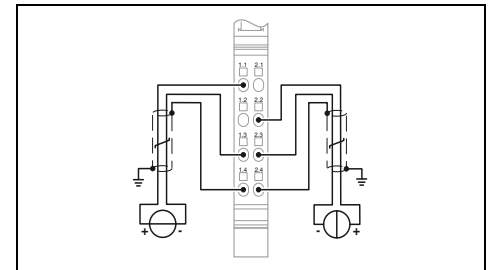

Technical data

Local bus interface	Inline data jumper
Connection method	24 V DC
Power supply for module electronics	Max. 18 mA
I/O supply voltage U_{ANA}	7,5 V DC (via voltage jumper)
Current consumption from U_{ANA}	Max. 60 mA
Communications power U_L	2-wire (shielded)
Current consumption from U_L	Max. 2 (single-ended)
Analog inputs	0 V ... 10 V / -10 V ... 10 V
Connection technology	0 mA ... 20 mA / 4 mA ... 20 mA / -20 mA ... 20 mA
Number of inputs	16 bits (15 bits + sign bit)
Voltage input signal	typ. 1.5 ms
Current input signal	IL, IB ST, IB RT, standardized display
Process data	Spring-cage connection
Measured value resolution	0.08 ... 1.5 mm ² / 0.08 ... 1.5 mm ² / 28 - 16
Process data update	69 g
Data formats	12.2 mm
General data	Ambient temperature (operation)
Connection method	-25 °C ... 55 °C
Connection data solid / stranded / AWG	Class A product, see page 527
Weight	
Width	
Ambient temperature (operation)	
EMC note	

Ordering data

Description	Type	Order No.	Pcs. / Pkt.
Inline analog input terminal , complete with accessories (connector plug and marking field)	IB IL AI 2/SF-PAC	2861302	1
- 8 inputs, initiator with supply outputs	IB IL AI 2/SF-XC-PAC	2701157	1
- for extended temperature range of -40°C ... +70°C			

Accessories

Shield connector	IB IL SCN 6-SHIELD-TWIN	2740245	5
------------------	-------------------------	---------	---



4 inputs



8 inputs



8 inputs, with initiator supply

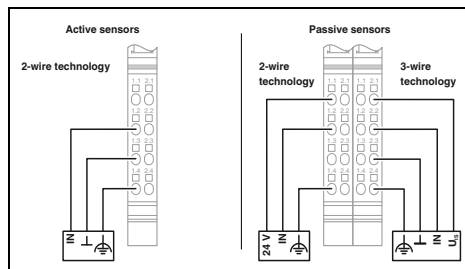
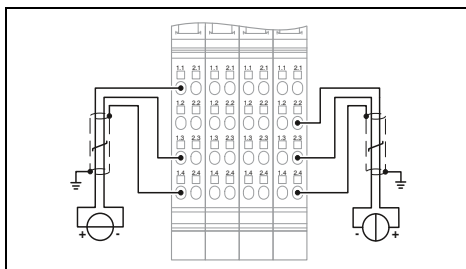
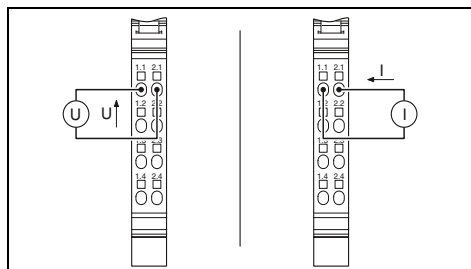

Technical data	
IB IL AI 4/U-PAC	IB IL AI 4/I-PAC
Inline data jumper	
24 V DC typ. 30 mA 7.5 V DC (via voltage jumper)	
2-wire	
4 (differential inputs, voltage)	4 (differential inputs, current)
0 V ... 10 V (default) / -10 V ... 10 V	-
-	0 mA ... 20 mA (default) / 4 mA ... 20 mA
12 bits (11 bits + sign bit)	13 bits (12 bits + sign bit)
typ. 250 µs (all channels) IB IL, S7-compatible	
Spring-cage connection 0.08 ... 1.5 mm ² / 0.08 ... 1.5 mm ² / 28 - 16 66 g 12.2 mm -25 °C ... 55 °C Class A product, see page 527	

Technical data	
Inline data jumper	
24 V DC Max. 35 mA 7.5 V DC (via voltage jumper) Max. 55 mA	
2-wire (shielded)	
Max. 8 (single-ended)	
0 V ... 5 V / -5 V ... 5 V / 0 V ... 10 V / -10 V ... 10 V	
0 mA ... 20 mA / 4 mA ... 20 mA / -20 mA ... 20 mA	
16 bits (15 bits + sign bit)	
typ. 1 ms (bus-synchronous) IL, IB ST, IB RT, standardized representation, PIO format	
Spring-cage connection 0.08 ... 1.5 mm ² / 0.08 ... 1.5 mm ² / 28 - 16 213 g 48.8 mm -25 °C ... 55 °C Class A product, see page 527	

Technical data	
Inline data jumper	
24 V DC Max. 40 mA 7.5 V DC (via voltage jumper) Max. 65 mA	
2-wire (shielded)	
Max. 8 (single-ended)	
-	
0 mA ... 20 mA / 4 mA ... 20 mA / -20 mA ... 20 mA	
16 bits (15 bits + sign bit)	
typ. 1 ms (bus-synchronous) IBS IL, IBS ST, IBS RT, standardized representation, PIO format	
Spring-cage connection 0.08 ... 1.5 mm ² / 0.08 ... 1.5 mm ² / 28 - 16 125 g 48.8 mm -25 °C ... 55 °C Class A product, see page 527	

Ordering data		
Type	Order No.	Pcs. / Pkt.
IB IL AI 4/U-PAC	2700459	1
IB IL AI 4/I-PAC	2700458	1

Ordering data		
Type	Order No.	Pcs. / Pkt.
IB IL AI 8/SF-PAC	2861412	1
IB IL AI 8/SF-XC-PAC	2701159	1

Ordering data		
Type	Order No.	Pcs. / Pkt.
IB IL AI 8/IS-PAC	2861661	1

Accessories		

Accessories		
IB IL SCN 6-SHIELD-TWIN	2740245	5

Accessories		
IB IL SCN 6-SHIELD-TWIN	2740245	5

Analog input terminals

The IB IL AI 4/EF (EF...Extended Functions) analog Inline terminal is suitable for connecting standard sensors for acquiring current and voltage signals.

Features:

- 4 differential signal inputs
- Connection of sensors in 2-, 3-, and 4-wire technology
- Measured value acquisition with 16-bit resolution
- Sensor supply with channel-specific integrated short-circuit and overload protection
- Short update time of < 1 ms, maximum for all channels
- Bus-synchronous provision of input values with very low jitter (< 10 μs)

Notes:

The driver function blocks can be obtained free of charge on the Internet at phoenixcontact.net/products under Download on the product page of the corresponding module.

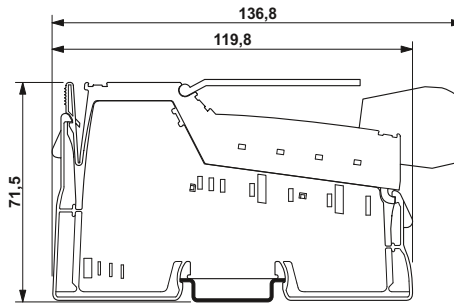

4 inputs, with extended functions

Ex:

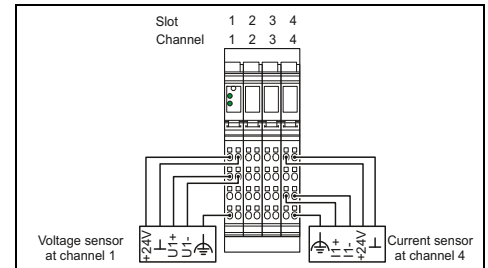

Technical data

Local bus interface	
Connection method	Inline data jumper
Power supply for module electronics	
I/O supply voltage U_{ANA}	24 V DC
Current consumption from U_{ANA}	Max. 20 mA
Communications power U_L	7.5 V DC (via voltage jumper)
Current consumption from U_L	Max. 100 mA
Analog inputs	
Connection technology	2, 3-wire
Number of inputs	Max. 4 (differential inputs, voltage or current can be selected separately)
Description of the input	Differential input, including sensor supply (24 V DC)
Voltage input signal	0 V ... 5 V / -5 V ... 5 V / 0 V ... 10 V / -10 V ... 10 V
Current input signal	0 mA ... 20 mA / 4 mA ... 20 mA / -20 mA ... 20 mA
Process data	
Measured value resolution	16 bits (15 bits + sign bit)
Process data update	typ. 1 ms (bus-synchronous)
Data formats	IL, IB ST, standardized display, S7-compatible
General data	
Connection method	Spring-cage connection
Connection data solid / stranded / AWG	0.08 ... 1.5 mm ² / 0.08 ... 1.5 mm ² / 28 - 16
Weight	210 g
Width	48.8 mm
EMC note	Class A product, see page 527

Ordering data

Description	Type	Order No.	Pcs. / Pkt.
Inline analog input terminal , complete with accessories (connector plug and marking field)	IB IL AI 4/EF-PAC	2878447	1
- for extended temperature range of -40°C ... +70°C	IB IL AI 4/EF-XC-PAC	2701215	1

Accessories

Shield connector	IB IL SCN 6-SHIELD-TWIN	2740245	5
------------------	-------------------------	---------	---

Analog input terminal with HART functionality

The Inline terminal offers the option of communicating with intelligent field devices using the standardized HART communication protocol.

It enables both analog and digital communication. The analog signal transmits the process information; the digital modulated signal also permits bidirectional communication with the HART-compatible sensor.

Features:

- Two differential signal inputs for current sensors
- Sensor connection with 2-wire connection technology
- Measured value acquisition with 16-bit resolution
- Point-to-point and multi-drop connections possible
- Polling and burst modes
- A maximum of 5 HART devices can be connected per channel
- A hand-held operator panel can be connected
- FDT/DTM support

Notes:

The driver function blocks can be obtained free of charge on the Internet at phoenixcontact.net/products under Download on the product page of the corresponding module.

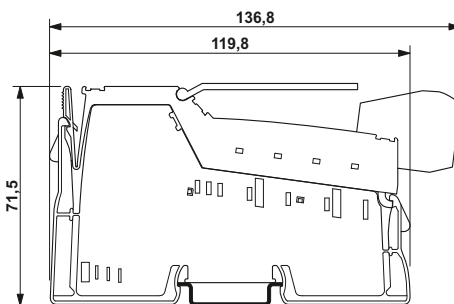

2 HART inputs

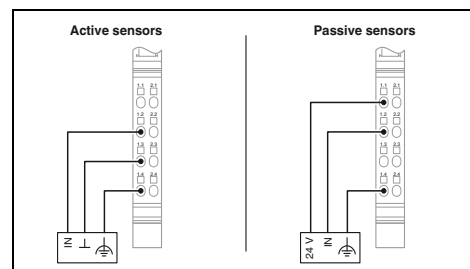

Technical data

Inline data jumper

24 V DC
Max. 150 mA
7.5 V DC
Max. 110 mA

2-wire (shielded)
Max. 2 (differential inputs, current)
4 mA ... 20 mA / 0 mA ... 25 mA

16 bits (15 bits + sign bit)
typ. 1 ms (bus-synchronous)
IL, standardized display

Spring-cage connection
0.08 ... 1.5 mm² / 0.08 ... 1.5 mm² / 28 - 16
134 g
48.8 mm
Class A product, see page 527

Ordering data

Type	Order No.	Pcs. / Pkt.
IB IL AI 2-HART-PAC	2862149	1

Accessories

IB IL SCN 6-SHIELD-TWIN	2740245	5
-------------------------	---------	---

Local bus interface
Connection method
Power supply for module electronics
I/O supply voltage U _{ANA}
Current consumption from U _{ANA}
Communications power U _L
Current consumption from U _L
Analog inputs
Connection technology
Number of inputs
Current input signal
Process data
Measured value resolution
Process data update
Data formats
General data
Connection method
Connection data solid / stranded / AWG
Weight
Width
EMC note

Description
Inline analog input terminal , complete with accessories (connector plug and marking field) - HART functionality

Shield connector

Strain gauge measurement terminals

Inline strain gauge measurement terminals enable the connection of load cells, force transducers, mass force transducers, and similar instruments, based on strain gauges.

IB IL SGI 2/F-PAC features:

- 2 fast inputs for strain gauge
- Bus-synchronous process data update with ≥ 1 ms (depending on the local bus cycle time)
- Typical deviation of the measuring range final value of $\pm 0.1\%$ (unipolar) or $\pm 0.2\%$ (bipolar)
- Optional: 16-sample mean-value generation

IB IL SGI 2/P-PAC features:

- 2 high-precision inputs for strain gauge
- Typical deviation of the measuring range final value of $\pm 0.01\%$
- Serial interface for external weight displays
- Zero point, tare, and standstill display
- Optional: 4-, 16-, and 32-sample mean-value generation

IB IL SGI 1/CAL features:

- 1 input for strain gauge
- Can be verified by EC type approval according to standards EN 45501 and OIML R76
- Electronic evaluating device to set up non-automatic weighing instruments (NAWI)
- Up to 3000 division counts
- Serial interface for external weight displays
- Zero point, tare, and standstill display
- Alibi memory for up to 65,536 measurement protocols
- Parameterization and calibration using FDT/DTM technology
- Various filter settings
- Calibration set for calibration required (Order No. [2700165](#))

Notes:

The driver function blocks can be obtained free of charge on the Internet at phoenixcontact.net/products under Download on the product page of the corresponding module.

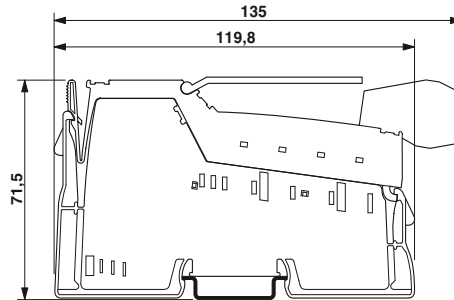

2 fast inputs

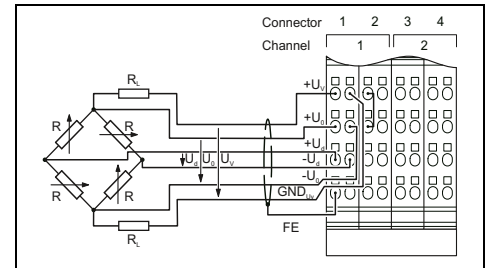

Technical data

Local bus interface	Inline data jumper
Connection method	24 V DC
Power supply for module electronics	typ. 32 mA (with maximum load of 58.3 Ω when $U_V = 5$ V)
I/O supply voltage U_{ANA}	7.5 V DC
Current consumption from U_{ANA}	Max. 85 mA
Communications power U_L	6 or 4-wire, twisted pair shielded cable
Current consumption from U_L	2
Analog inputs	Input channels for strain gauge
Connection technology	Measuring range specified by selecting the characteristic and the bridge voltage
Number of inputs	3.3 V / 5 V
Description of the inputs	Voltage output
Bridge difference U_d	2
Bridge voltage U_0	> 58.3 Ω (typical; permissible total resistance of the strain gauge)
Analog outputs	typ. 55 mA (at $U_V = 3.3$ V) / typ. 85 mA (at $U_V = 5$ V)
Description of the outputs	+1 mV/V, +2 mV/V, +3 mV/V, +4 mV/V
Number of outputs	± 1 mV/V, ± 2 mV/V, ± 3 mV/V, ± 4 mV/V
Impedance	15 bit + sign bit
Output current	Process data update
Characteristics	1 x per local bus cycle at a bus cycle time ≥ 1 ms
Unipolar	General data
Bipolar	Connection method
Measured value representation	Spring-cage connection
Process data update	0.08 ... 1.5 mm ² / 0.08 ... 1.5 mm ² / 28 - 16
General data	190 g
Connection method	48.8 mm
Connection data solid / stranded / AWG	Class A product, see page 527
Weight	Ordering data
Width	Type
EMC note	Order No.
	Pcs. / Pkt.

Description	Inline analog strain gauge input terminal , complete with accessories (connector plug and marking field)
	- Fast inputs
	- Precise inputs
	- Can be verified, precise input

Calibration set, approval-related	
Shield connector	

Type	Order No.	Pcs. / Pkt.
IB IL SGI 2/F-PAC	2878638	1

Accessories		
IB IL SCN 6-SHIELD-TWIN	2740245	5



2 precise inputs



1 input that can be verified

Ex: Ex

PTB-BG

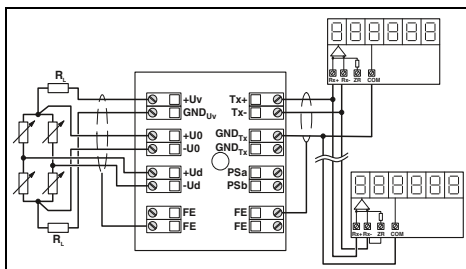
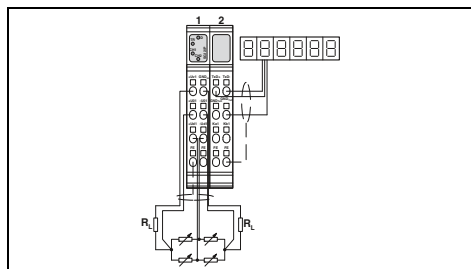

Technical data

Technical data

Inline data jumper

Inline data jumper

24 V DC
Max. 100 mA
7.5 V DC
Max. 100 mA

24 V DC
Max. 50 mA
7.5 V DC
typ. 80 mA

6 or 4-wire, twisted pair shielded cable

6-wire, twisted pair shielded cable

2
Input channels for strain gauge
Measuring range specified by selecting the characteristic

1
Input channel for strain gauge
Measuring range specified by selecting the characteristic

5 V

5 V

Voltage output
2
> 55 Ω (per channel)

Voltage output
1
> 55 Ω

Max. 90 mA (per channel)

Max. 90 mA

±1 mV/V, ±2 mV/V, ±3 mV/V, ±3.33 mV/V, ±4 mV/V, ±5 mV/V

±1 mV/V, ±2 mV/V, ±3 mV/V, ±3.33 mV/V, ±4 mV/V, ±5 mV/V

15 bits + sign bit (process data); 15 bits + sign bit and measured display value in the ASCII character set (PCP)

Process data: status bits and measured value including decimal places of the gross/net display

typ. 100 ms (12.5 ms, depends on the configuration)

typ. 100 ms

Spring-cage connection
0.08 ... 1.5 mm² / 0.08 ... 1.5 mm² / 28 - 16
220 g
48.8 mm
Class A product, see page 527

Spring-cage connection
0.08 ... 1.5 mm² / 0.08 ... 1.5 mm² / 28 - 16
160 g
48.8 mm
Class A product, see page 527

Ordering data

Ordering data

Type	Order No.	Pcs. / Pkt.
IB IL SGI 2/P-PAC	2884907	1

Type	Order No.	Pcs. / Pkt.
IB IL SGI 1/CAL	2700064	1

Accessories

Accessories

IB IL SCN 6-SHIELD-TWIN	2740245	5
-------------------------	---------	---

IB IL SGI EU CALSET	2700165	1
IB IL SCN-6 SHIELD	2726353	5

Temperature measurement terminals

These Inline terminals can be used to connect thermocouples (UTH) and resistive temperature sensors (RTD).

Features of UTH inputs:

- Connection of thermocouples according to DIN EN 60584-1 and DIN 43710
- Absolute and differential temperature measurement (configurable)
- Measured value acquisition with 16-bit resolution
- -15 mV to +85 mV linear input
- Internal and external cold junction

Features of RTD inputs:

- Pt, Ni, Cu, KTY sensor types according to DIN and SAMA
- Connection of sensors in 2-, 3-, and 4-wire technology
- Measured value acquisition with 16-bit resolution
- Channel scout for optical channel identification

The Inline thermistor terminal IB IL 24 TC is used for the evaluation of PTC thermistors. It makes it possible to monitor the temperature of motors and can be used in conjunction with Inline motor starters.

Notes:

The driver function blocks can be obtained free of charge on the Internet at phoenixcontact.net/products under Download on the product page of the corresponding module.

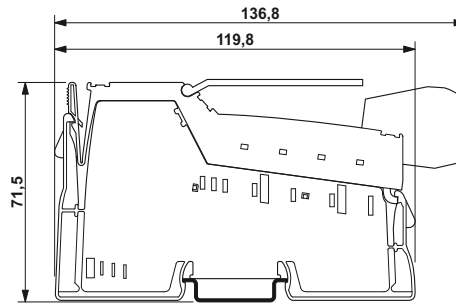

2 UTH inputs

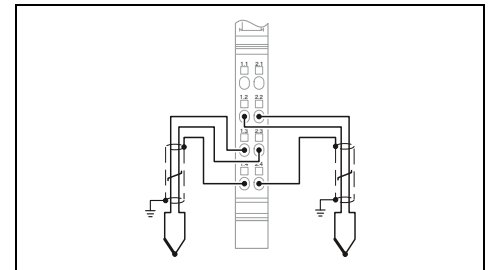

Technical data

Local bus interface	Inline data jumper
Connection method	24 V DC
Power supply for module electronics	Max. 18 mA
I/O supply voltage U_{ANA}	7,5 V DC (via voltage jumper)
Current consumption from U_{ANA}	Max. 60 mA
Communications power U_L	
Current consumption from U_L	
Analog inputs	
Connection technology	2-wire (shielded)
Number of inputs	2
Accuracy	typ. $\pm 0.6\text{ }^\circ\text{C}$
Description of the input	Inputs for thermocouples or linear voltage
Linear resistance measuring range	-
Sensor types (RTD) that can be used	-
Sensor types that can be used (TC)	U, T, L, J, E, K, N, S, R, B, C, W, HK
Measuring principle	Successive approximation
Process data update	30 ms (for both channels)
General data	
Connection method	Spring-cage connection
Connection data solid / stranded / AWG	0.08 ... 1.5 mm ² / 0.08 ... 1.5 mm ² / 28 - 16
Weight	67 g
Width	12.2 mm
EMC note	Class A product, see page 527

Ordering data

Description	Type	Order No.	Pcs. / Pkt.
Inline analog input terminal , complete with accessories (connector plug and marking field)			
- With extended functions	IB IL TEMP 2 UTH-PAC	2861386	1
- For extended temperature range of -40°C ... +70°C	IB IL TEMP 2 UTH-XC-PAC	2701216	1

Accessories

Shield connector	IB IL SCN 6-SHIELD-TWIN	2740245	5
-------------------------	-------------------------	---------	---



2 RTD inputs



4 or 8 RTD inputs



1 thermistor input

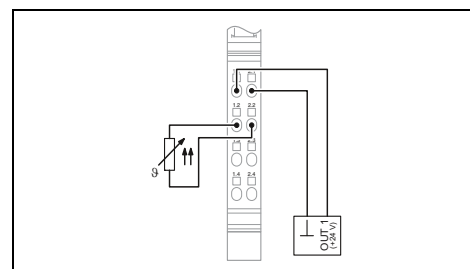
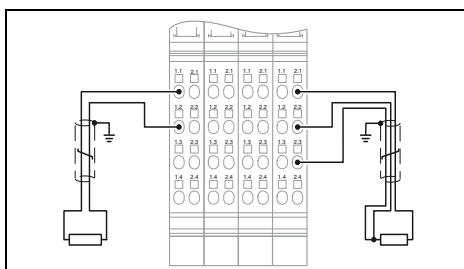
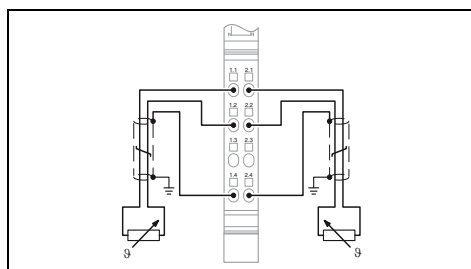

Technical data

Technical data

Technical data

Inline data jumper
24 V DC Max. 18 mA 7.5 V DC (via voltage jumper) Max. 60 mA
2, 3-wire 2 typ. ± 0.26 °C Input for resistive temperature sensors
0 Ω ... 400 Ω / 0 Ω ... 4 kΩ
Pt, Ni, KTY, Cu sensors, linear resistors
-
Successive approximation
30 ms
Spring-cage connection 0.08 ... 1.5 mm ² / 0.08 ... 1.5 mm ² / 28 - 16 67 g 12.2 mm Class A product, see page 527

IB IL TEMP 4/8 RTD-PAC	IB IL TEMP 4/8 RTD/EF-PAC
Inline data jumper	
24 V DC typ. 28 mA 7.5 V DC (via voltage jumper) typ. 75 mA	
2, 3-wire	4-wire
typ. ± 0.5 °C	8 typ. ± 0.05 °C
Input for resistive temperature sensors	
0 Ω ... 400 Ω / 0 Ω ... 20 kΩ	0 Ω ... 500 Ω / 0 Ω ... 5 kΩ
Pt, Ni, KTY, Cu sensors, linear resistors	Pt, Ni, KTY sensors, linear resistors
-	-
Successive approximation	Sigma/Delta process
6 ms (up to 230 ms possible depending on operating mode)	1.8 s (up to 3.3 s possible depending on operating mode)
Spring-cage connection 0.08 ... 1.5 mm ² / 0.08 ... 1.5 mm ² / 28 - 16 190 g 48.8 mm Class A product, see page 527	Spring-cage connection 0.08 ... 1.5 mm ² / 0.08 ... 1.5 mm ² / 28 - 16 50 g 12.2 mm Class A product, see page 527

Inline data jumper
24 V DC 0 A DC 7.5 V DC (via voltage jumper) Max. 60 mA
2-wire 1 - Input for PTC thermistor
2.7 kΩ ... 3.5 kΩ (shutdown range, total resistance) / 50 Ω ... 2.25 kΩ (operating range, total resistance)
PTC thermistor according to DIN 44081 or DIN 44082
-
-
-
Spring-cage connection 0.08 ... 1.5 mm ² / 0.08 ... 1.5 mm ² / 28 - 16 50 g 12.2 mm Class A product, see page 527

Ordering data

Ordering data

Ordering data

Type	Order No.	Pcs. / Pkt.
IB IL TEMP 2 RTD-PAC	2861328	1
IB IL TEMP 2 RTD-XC-PAC	2701217	1

Type	Order No.	Pcs. / Pkt.
IB IL TEMP 4/8 RTD-PAC	2863915	1
IB IL TEMP 4/8 RTD/EF-PAC	2897402	1
IB IL TEMP 4/8 RTD/EF-XC-PAC	2701218	1

Type	Order No.	Pcs. / Pkt.
IB IL 24 TC-PAC	2861360	1

Accessories

Accessories

Accessories

IB IL SCN 6-SHIELD-TWIN	2740245	5
-------------------------	---------	---

IB IL SCN 6-SHIELD-TWIN	2740245	5
-------------------------	---------	---

IB IL SCN-6 SHIELD	2726353	5
--------------------	---------	---

For the control cabinet (IP20) – Inline

Analog output terminals

These Inline terminals are used in applications in which analog actuators are to be controlled.

With these terminals, common current and voltage output ranges can be configured individually and channel-specifically.

Features:

- Connection of sensors in 2-wire technology
- Measured value output with 16-bit resolution
- Load of up to 500 Ω
- Bipolar outputs
- Short-circuit-proof current outputs
- Short update time of < 1 ms

Notes:

The driver function blocks can be obtained free of charge on the Internet at phoenixcontact.net/products under Download on the product page of the corresponding module.



1 output



2 outputs

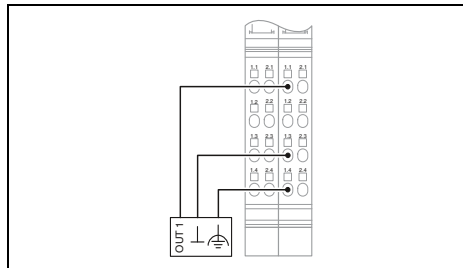

Technical data

Local bus interface	
Connection method	Inline data jumper
Power supply for module electronics	
I/O supply voltage U_{ANA}	24 V DC
Current consumption from U_{ANA}	Max. 65 mA
Communications power U_L	7.5 V DC (via voltage jumper)
Current consumption from U_L	Max. 40 mA
Analog outputs	
Connection technology	2-wire (shielded)
Number of outputs	1
Voltage output signal	0 V ... 10 V
Load/output load voltage output	> 2 kΩ 0.05 %
Current output signal	0 mA ... 20 mA / 4 mA ... 20 mA
Load/output load current output	> 500 Ω
Protective circuit	Transient protection of outputs
Characteristics	
Representation of output values	16 bits (15 bits + sign)
Process data update	< 1 ms
General data	
Connection method	Spring-cage connection
Connection data solid / stranded / AWG	0.08 ... 1.5 mm ² / 0.08 ... 1.5 mm ² / 28 - 16
Weight	126 g
Dimensions	24.4 mm / 135 mm / 71.5 mm
EMC note	Class A product, see page 527

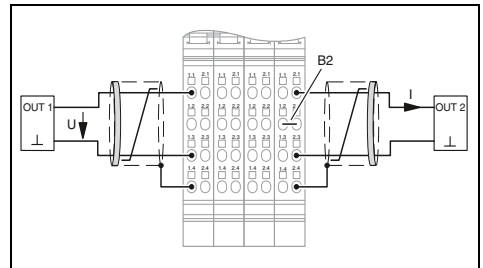

Technical data

Local bus interface	
Connection method	Inline data jumper
Power supply for module electronics	
I/O supply voltage U_{ANA}	24 V DC
Current consumption from U_{ANA}	Max. 95 mA
Communications power U_L	7.5 V DC (via voltage jumper)
Current consumption from U_L	Max. 45 mA
Analog outputs	
Connection technology	2-wire (shielded)
Number of outputs	2
Voltage output signal	0 V ... 10 V
Load/output load voltage output	> 2 kΩ 0.03%
Current output signal	0 mA ... 20 mA / 4 mA ... 20 mA
Load/output load current output	> 500 Ω
Protective circuit	Short-circuit protection of outputs
Characteristics	
Representation of output values	16 bits (15 bits + sign)
Process data update	< 1 ms
General data	
Connection method	Spring-cage connection
Connection data solid / stranded / AWG	0.08 ... 1.5 mm ² / 0.08 ... 1.5 mm ² / 28 - 16
Weight	125 g
Dimensions	48.8 mm / 135 mm / 71.5 mm
EMC note	Class A product, see page 527

Ordering data

Description	Type	Order No.	Pcs. / Pkt.
Inline analog output terminal , complete with accessories (connector plug and marking field) - For extended temperature range of -40°C ... +70°C	IB IL AO 1/SF-PAC	2861315	1
	IB IL AO 1/SF-XC-PAC	2701219	1

Ordering data

Description	Type	Order No.	Pcs. / Pkt.
Inline analog output terminal , complete with accessories (connector plug and marking field)	IB IL AO 2/SF-PAC	2863083	1

Accessories

Accessories	Type	Order No.	Pcs. / Pkt.
Connector set Shield connector for analog Inline terminals Connector	IB IL AO/CNT-PLSET	2732664	1

Accessories

Accessories	Type	Order No.	Pcs. / Pkt.
Shield connector for analog Inline terminals Connector	IB IL SCN-6 SHIELD	2726353	5



2 outputs, bipolar



2 outputs, multifunctional



4/8 outputs, bipolar

Ex:

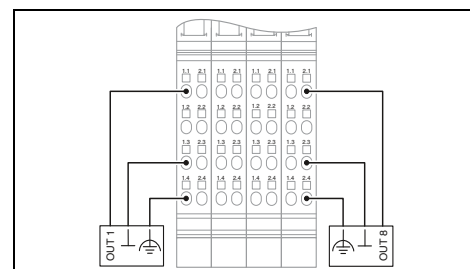
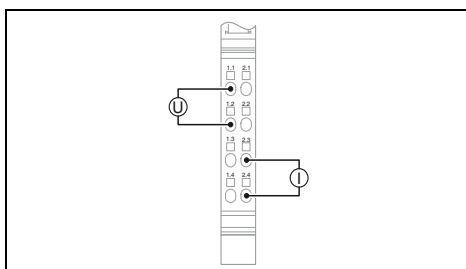
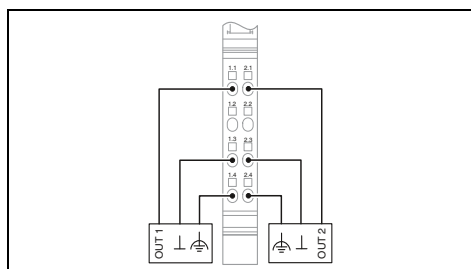

Technical data
Inline data jumper
24 V DC Max. 35 mA 7.5 V DC (via voltage jumper) Max. 40 mA
2-wire (shielded) 2 0 V ... 10 V / -10 V ... 10 V > 2 kΩ 0.05 % - - Transient protection of outputs
16 bits (15 bits + sign) < 2 ms
Spring-cage connection 0.08 ... 1.5 mm ² / 0.08 ... 1.5 mm ² / 28 - 16 48 g 12.2 mm / 136.8 mm / 71.5 mm Class A product, see page 527

Technical data
Inline data jumper
24 V DC typ. 24 mA (no-load) 7.5 V DC (via voltage jumper) typ. 55 mA
2-wire (shielded, twisted pair) 2 0 V ... 10 V / -10 V ... 10 V > 1 kΩ 0 mA ... 20 mA / 4 mA ... 20 mA / -20 mA ... 20 mA ≤ 450 Ω Short-circuit and overload protection Transient protection
12 bits (11 bits + sign bit) Bus-synchronous
Spring-cage connection 0.08 ... 1.5 mm ² / 0.08 ... 1.5 mm ² / 28 - 16 66 g 12.2 mm / 119.8 mm / 71.5 mm Class A product, see page 527

Technical data
Inline data jumper
24 V DC typ. 72 mA 7.5 V DC (via voltage jumper) typ. 80 mA
2, 3-wire 8 0 V ... 10 V / -10 V ... 10 V / 0 V ... 5 V / -5 V ... 5 V > 2 kΩ 0.05 % - - Transient protection of outputs
16 bits (15 bits + sign) < 2 ms (depends on operating mode)
Spring-cage connection 0.08 ... 1.5 mm ² / 0.08 ... 1.5 mm ² / 28 - 16 215 g 48.8 mm / 136.8 mm / 71.5 mm Class A product, see page 527

Ordering data		
Type	Order No.	Pcs. / Pkt.
IB IL AO 2/U/BP-PAC	2861467	1

Ordering data		
Type	Order No.	Pcs. / Pkt.
IB IL AO 2/UI-PAC	2700775	1

Ordering data		
Type	Order No.	Pcs. / Pkt.
IB IL AO 4/8/U/BP-PAC	2878036	1
IB IL AO 4/8/U/BP-XC-PAC	2701164	1

Accessories		
Type	Order No.	Pcs. / Pkt.
IB IL SCN 6-SHIELD-TWIN	2740245	5

Accessories		
Type	Order No.	Pcs. / Pkt.

Accessories		
Type	Order No.	Pcs. / Pkt.
IB IL SCN-8	2726337	10

Machine Edition (ME)

The Inline ME versions (Machine Edition) are designed to be used in a space-saving and inexpensive way, for example with machine applications if minimum connection technology is possible.

The digital Inline input terminal is designed for the connection of digital signals, such as are emitted from control switches, limit switches or proximity switches, and the digital Inline output terminals are designed for the connection of digital actuators, such as electromagnetic valves, contactors or visual indicators.

The digital ME variants are only available in packages of 4.



4/16 digital inputs



4/16 digital outputs

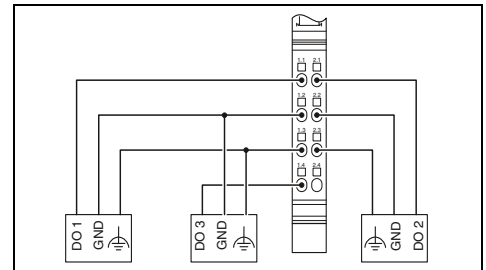
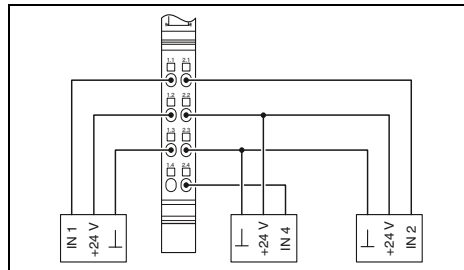

Technical data

	IB IL 24 DI 4-ME	IB IL 24 DI 16-ME
Local bus interface	Inline data jumper	
Connection method	24 V DC (via voltage jumper)	
Power supply for module electronics	19.2 V DC ... 30 V DC (including all tolerances, including ripple)	
Supply voltage	40 mA	
Supply voltage range	Spring-cage connection	
	2, 3-wire	
Supply current	4 (EN 61131-2 type 1)	16 (EN 61131-2 type 1)
Digital inputs	< 1 ms	
Connection method	-	
Connection technology	-	
Number of inputs	-	
Typical response time	-	
Digital outputs	Spring-cage connection	
Connection method	2, 3-wire	
Connection technology	4	16
Maximum number of outputs	500 mA	
Maximum output current per channel	-	
General data	Spring-cage connection	
Connection method	0.08 ... 1.5 mm ² / 0.08 ... 1.5 mm ² / 28 - 16	
Connection data solid / stranded / AWG	59 g	122 g
Weight	12.2 mm / 119.8 mm / 71.5 mm	48.8 mm / 119.8 mm / 71.5 mm
Dimensions W / H / D	-25 °C ... 55 °C	
Dimensions	Class A product, see page 527	
Ambient temperature (operation)	-	
EMC note	-	

Technical data

	IB IL 24 DO 4-ME	IB IL 24 DO 16-ME
Local bus interface	Inline data jumper	
Connection method	24 V DC (via voltage jumper)	
Power supply for module electronics	19.2 V DC ... 30 V DC (including all tolerances, including ripple)	
Supply voltage	44 mA	90 mA
Supply voltage range	Spring-cage connection	
Supply current	2, 3-wire	
Digital inputs	-	-
Connection method	-	
Connection technology	-	
Number of inputs	-	
Typical response time	-	
Digital outputs	Spring-cage connection	
Connection method	2, 3-wire	
Connection technology	4	16
Maximum number of outputs	500 mA	
Maximum output current per channel	-	
General data	Spring-cage connection	
Connection method	0.08 ... 1.5 mm ² / 0.08 ... 1.5 mm ² / 28 - 16	
Connection data solid / stranded / AWG	59 g	130 g
Weight	12.2 mm / 119.8 mm / 71.5 mm	48.8 mm / 119.8 mm / 71.5 mm
Dimensions W / H / D	-25 °C ... 55 °C	
Dimensions	Class A product, see page 527	
Ambient temperature (operation)	-	
EMC note	-	

Ordering data

Description	Type	Order No.	Pcs. / Pkt.
Inline digital input terminal , Machine Edition variant, complete with accessories (connector plug and marking field)			
- 4 inputs	IB IL 24 DI 4-ME	2863928	4
- 16 inputs	IB IL 24 DI 16-ME	2897156	4
Inline digital output terminal , Machine Edition variant, complete with accessories (connector plug and marking field)			
- 4 outputs			
- 16 outputs			

Ordering data

Description	Type	Order No.	Pcs. / Pkt.
Inline digital output terminal , Machine Edition variant, complete with accessories (connector plug and marking field)			
- 4 outputs	IB IL 24 DO 4-ME	2863931	4
- 16 outputs	IB IL 24 DO 16-ME	2897253	4

Machine Edition (ME)

The IB IL AI 2/SF-ME analog Inline terminal is suitable for connecting standard sensors for acquiring current and voltage signals.

The IB IL AO 2/U/BP-ME analog Inline terminal supplies the typical voltage signals 0 ... 10 V and ±10 V as manipulated variables.

Both terminals can be used to implement cost-optimized applications.

Features:

- Connection of sensors in 2- or 3-wire technology
- Measured value acquisition with 12-bit resolution



2 analog inputs



2 analog outputs

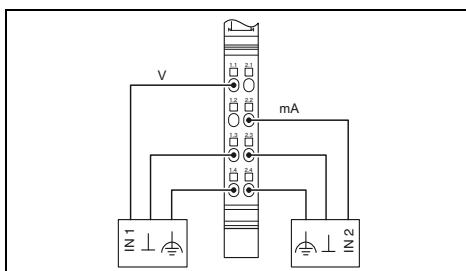

Technical data

Local bus interface	
Connection method	Inline data jumper
Power supply for module electronics	
I/O supply voltage U _{ANA}	24 V DC
Current consumption from U _{ANA}	Max. 18 mA
Analog inputs	
Connection technology	2, 3-wire
Number of inputs	Max. 2 (single-ended)
Voltage input signal	0 V ... 10 V / -10 V ... 10 V
Current input signal	0 mA ... 20 mA / 4 mA ... 20 mA / -20 mA ... 20 mA
Measured value resolution	13 bits (12 bits + sign bit)
Process data update	typ. 1.5 ms
Data formats	IL, IB ST, IB RT, standardized display
Analog outputs	
Connection technology	-
Number of outputs	-
Voltage output signal	-
Representation of output values	-
Process data update	-
Data formats	-
General data	
Connection method	Spring-cage connection
Connection data solid / stranded / AWG	0.08 ... 1.5 mm ² / 0.08 ... 1.5 mm ² / 28 - 16
Weight	47 g
Dimensions	12.2 mm / 119.8 mm / 71.5 mm
Ambient temperature (operation)	-25 °C ... 55 °C
EMC note	Class A product, see page 527

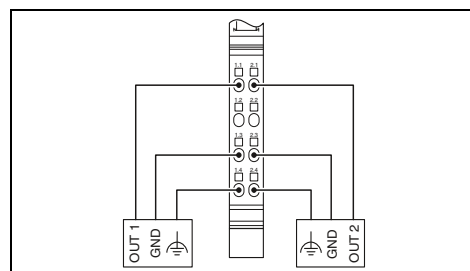

Technical data

Local bus interface	
Connection method	Inline data jumper
Power supply for module electronics	
I/O supply voltage U _{ANA}	24 V DC
Current consumption from U _{ANA}	Max. 35 mA
Analog outputs	
Connection technology	2-wire
Number of outputs	2
Voltage output signal	0 V ... 10 V / -10 V ... 10 V
Representation of output values	13 bits (12 bits + sign)
Process data update	< 1 ms
Data formats	IL, IB ST
General data	
Connection method	Spring-cage connection
Connection data solid / stranded / AWG	0.08 ... 1.5 mm ² / 0.08 ... 1.5 mm ² / 28 - 16
Weight	48 g
Dimensions	12.2 mm / 119.8 mm / 71.5 mm
Ambient temperature (operation)	-25 °C ... 55 °C
EMC note	Class A product, see page 527

Ordering data

Type	Order No.	Pcs. / Pkt.
IB IL AI 2/SF-ME	2863944	1

Ordering data

Type	Order No.	Pcs. / Pkt.
IB IL AO 2/U/BP-ME	2863957	1

Local bus interface	
Connection method	
Power supply for module electronics	
I/O supply voltage U _{ANA}	
Current consumption from U _{ANA}	
Analog inputs	
Connection technology	
Number of inputs	
Voltage input signal	
Current input signal	
Measured value resolution	
Process data update	
Data formats	
Analog outputs	
Connection technology	
Number of outputs	
Voltage output signal	
Representation of output values	
Process data update	
Data formats	
General data	
Connection method	
Connection data solid / stranded / AWG	
Weight	
Dimensions	W / H / D
Ambient temperature (operation)	
EMC note	

Description	
Inline analog input terminal, Machine Edition variant, complete with accessories (connector plug and marking field)	
Inline analog output terminal, Machine Edition variant, complete with accessories (connector plug and marking field)	

Branch terminals

The IBS IL 24 RB-T-PAC and IBS IL 24 RB-LK-PAC branch terminals make it possible to add more system levels to an INTERBUS network. A total of up to 15 levels can be operated in the network.

The IBS IL 24 RB-T terminal uses a copper cable as the transmission medium. The IBS IL 24 RB-LK terminal uses fiber optics as the outgoing remote bus interface.

The IB IL 24 FLM-PAC Inline branch terminal enables the direct connection of Fieldline Modular M8 and M12 local bus devices to an Inline Modular station.

In contrast to the IB IL 24 FLM-PAC, the IB IL 24 FLM MUL-TI-PAC branch terminal enables the integration of several Fieldline Modular M8 local buses in an Inline station.

When combined with the IB IL 24 LSKIP-PAC local bus extension terminal, it is possible to jump between two rows within an Inline station. This means that the Inline station can extend onto another DIN rail without having to use a new bus coupler.

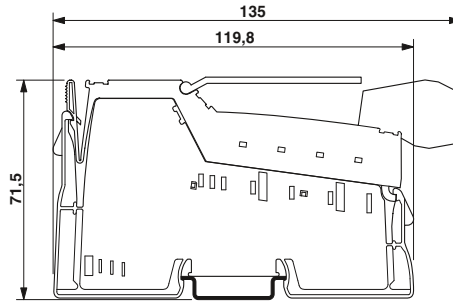

Remote bus branch

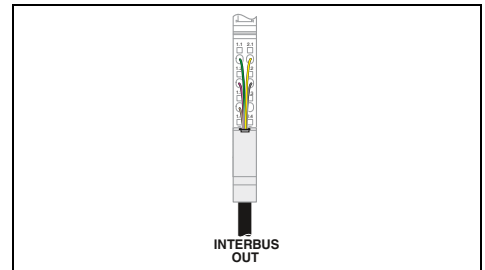

Technical data

Interface	
Connection method	Inline data jumper Inline shield connector
Local bus interface	
Connection method	Inline data jumper
Power supply for module electronics	
Supply voltage	24 V DC (via voltage jumper)
Supply voltage range	19.2 V DC ... 30 V DC (including all tolerances, including ripple)
Max. current consumption	-
Current consumption from U_L	-
Current consumption from U_{ANA}	typ. 29 mA
Power supply at U_L	-
Power supply at U_{ANA}	-
General data	
Connection method	Spring-cage connection
Connection data solid / stranded / AWG	0.08 ... 1.5 mm ² / 0.08 ... 1.5 mm ² / 28 - 16
Weight	67 g
Width	12.2 mm
Ambient temperature (operation)	-25 °C ... 55 °C
EMC note	Class A product, see page 527

Ordering data

Description	Type	Order No.	Pcs. / Pkt.
Inline branch terminal , complete with accessories (connector plug and marking field)	IBS IL 24 RB-T-PAC	2861441	1
- For extended temperature range of -40°C ... +70°C	IBS IL 24 RB-T-XC-PAC	2701151	1

Accessories

Inline segment terminal , complete with accessories (connector plug and marking field)			
Shield connector for analog Inline terminals	IB IL SCN-6 SHIELD	2726353	5



Fiber optic remote bus branch



Fieldline Modular extension

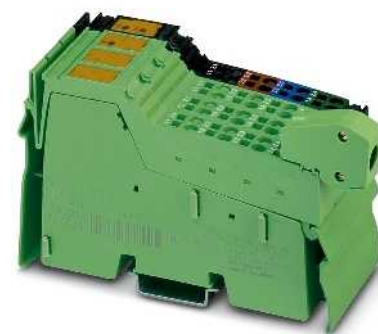

Local bus extension terminal

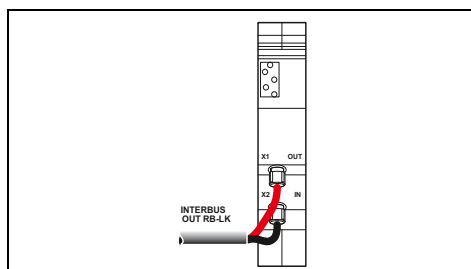

Technical data

FSMA connector
Inline data jumper
24 V DC (via voltage jumper) 19.2 V DC ... 30 V DC (including all tolerances, including ripple)
-
-
typ. 42 mA
-
-
FSMA connector
- ... - / - ... - / -
89 g
24.4 mm
-25 °C ... 55 °C
Class A product, see page 527

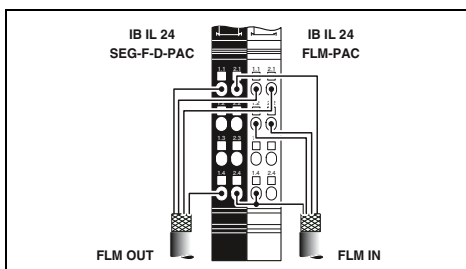

Technical data

IB IL 24 FLM-PAC	IB IL 24 FLM MULTI-PAC
Inline shield connector	
Inline data jumper	
110 mA	50 mA
Spring-cage connection	
0.08 ... 1.5 mm ² / 0.08 ... 1.5 mm ² / 28 - 16	
43 g	
12.2 mm	
-25 °C ... 55 °C	
Class A product, see page 527	

Ordering data

Type	Order No.	Pcs. / Pkt.
IB IL 24 FLM-PAC	2736903	1
IB IL 24 FLM MULTI-PAC	2737009	1

Accessories

IB IL 24 SEG/F-PAC	2861373	1
IB IL SCN-6 SHIELD	2726353	5

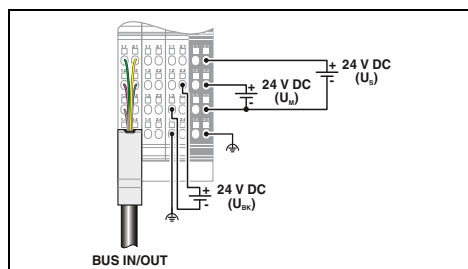

Technical data

Inline shield connector
Inline data jumper
24 V DC 19.2 V DC ... 30 V DC
Max. 1.25 A (with max. number of connected I/O terminal blocks)
-
-
Max. 2 A DC (observe derating) Max. 0.5 A DC (observe derating)
Spring-cage connection
0.08 ... 1.5 mm ² / 0.08 ... 1.5 mm ² / 28 - 16
207 g
48.8 mm
-25 °C ... 55 °C

Ordering data

Type	Order No.	Pcs. / Pkt.
IB IL 24 LSKIP-PAC	2897457	1

Accessories

--	--	--

Serial communication terminals

Inline communication terminals can be used to connect devices with a serial interface (e.g., barcode scanners).

Features:

- RS-232 or RS-485/RS-422 interface depending on the version
- Support for various protocols (e.g., end-to-end protocol)
- Baud rates of up to 250 kBaud
- Communication via process data (PRO versions)

Notes:

The driver function blocks can be obtained free of charge on the Internet at phoenixcontact.net/products under Download on the product page of the corresponding module.

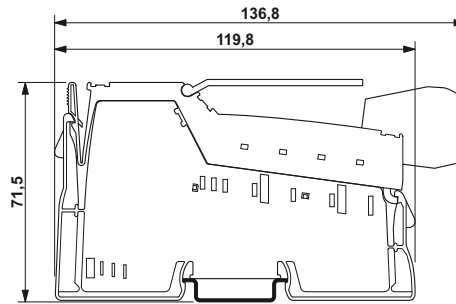

1 serial RS-232 interface, process data communication

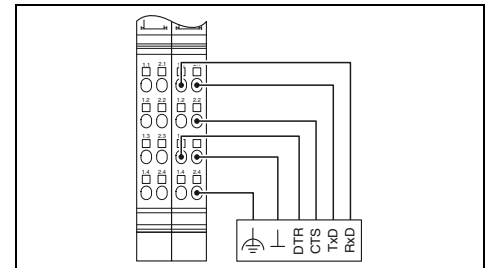

Technical data

Local bus interface	
Connection method	Inline data jumper
Serial port	
Interface	RS-232
Connection method	Spring-cage connection
Power supply for module electronics	
I/O voltage	24 V DC (via voltage jumper)
I/O voltage range	19.2 V DC ... 30 V DC (including all tolerances, including ripple)
Communications power U_L	7.5 V (via voltage jumper)
Current consumption from U_L	typ. 155 mA
Serial input/output channel	
Input buffer	4 kbyte
Output buffer	1 kbyte
Transmission speed	110 bps ... 38,400 bps (configurable)
Data bits	7 or 8
Stop bits	1 or 2
Parity	Even, odd or no parity
Transmission type	Transparent mode, end-end mode, dual buffer mode, 3964R, XON/XOFF
General data	
Connection method	Spring-cage connection
Connection data solid / stranded / AWG	0.08 ... 1.5 mm ² / 0.08 ... 1.5 mm ² / 28 - 16
Weight	135 g
Width	24.4 mm
Ambient temperature (operation)	-25 °C ... 55 °C

Ordering data

Type	Order No.	Pcs. / Pkt.
IB IL RS 232-PRO-PAC	2878722	1

Accessories

Connector set	IB IL AO/CNT-PLSET	2732664	1
---------------	--------------------	---------	---



1 serial RS-485/RS-422 interface, process data communication



1 serial RS-485/422 or RS-232 interface, process data communication

UL US ABS BSH CE RoHS

UL

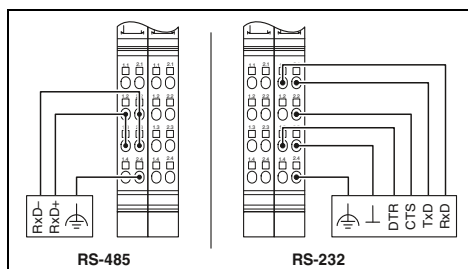
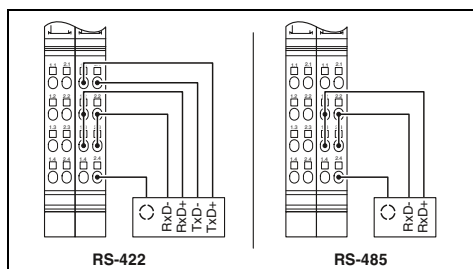

Technical data
Inline data jumper
RS-422/485 Spring-cage connection
24 V DC (via voltage jumper) 19.2 V DC ... 30 V DC (including all tolerances, including ripple)
7.5 V (via voltage jumper) typ. 170 mA
4 kbyte 1 kbyte 110 bps ... 38,400 bps (configurable) 7 or 8 1 or 2 Even, odd or no parity Transparent mode, end-end mode, dual buffer mode, 3964R, XON/XOFF, MOVILINK protocol
Spring-cage connection 0.08 ... 1.5 mm ² / 0.08 ... 1.5 mm ² / 28 - 16 135 g 24.4 mm -25 °C ... 55 °C

Technical data
Inline data jumper
RS-232, RS-485, RS-422 Inline connector
24 V DC (via voltage jumper) 19.2 V DC ... 30 V DC (including all tolerances, including ripple)
7.5 V (via voltage jumper) typ. 78 mA
4 kbyte 1 kbyte 110 bps ... 38,400 bps (configurable) 5 ... 8 1 or 2 Even, odd or no parity Transparent mode, end-to-end mode, XON/XOFF
Spring-cage connection 0.08 ... 1.5 mm ² / 0.08 ... 1.5 mm ² / 28 - 16 135 g 24.4 mm -25 °C ... 55 °C

Ordering data		
Type	Order No.	Pcs. / Pkt.
IB IL RS 485/422-PRO-PAC	2863627	1

Ordering data		
Type	Order No.	Pcs. / Pkt.
IB IL RS UNI-PAC	2700893	1

Accessories		
IB IL AO/CNT-PLSET	2732664	1

Accessories		
IB IL AO/CNT-PLSET	2732664	1

DALI terminals

The IB IL DALI/PWR-PAC terminal is a DALI master, which in addition to DALI communication also provides the DALI bus supply, without having to connect an external DALI power supply unit. This terminal can be easily extended with up to three IB IL DALI-PAC devices, each of which represents another DALI master.

Features:

- Up to 64 DALI devices per master terminal
- Safe electrical isolation of the DALI bus
- Protection of the DALI bus against accidental connection of the mains voltage (up to 250 V AC)
- Diagnosis, transmitting and receiving display
- Function blocks for PC Worx are available



DALI master



Extension for DALI master

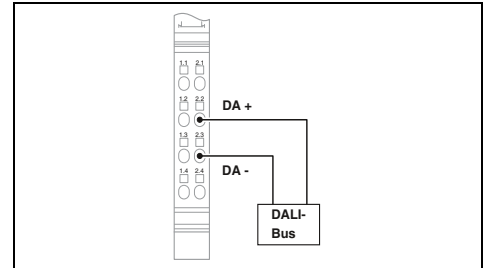
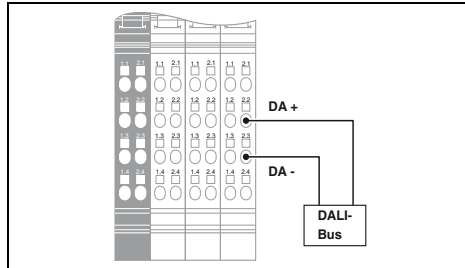

Technical data

Local bus interface
Connection method
Power supply for module electronics
Supply voltage
Supply voltage range
Current consumption from U_L
General data
Connection method
Connection data solid / stranded / AWG
Weight
Dimensions
Ambient temperature (operation)

Inline data jumper
24 V DC (nominal value)
19.2 V DC ... 30 V DC
Max. 38 mA
Spring-cage connection
0.2 ... 1.5 mm ² / 0.08 ... 1.5 mm ² / 24 - 16
194 g
48.8 mm / 119.8 mm / 71.5 mm
-25 °C ... 55 °C

Technical data

Inline data jumper
24 V DC (nominal value)
19.2 V DC ... 30 V DC
Max. 38 mA
Spring-cage connection
0.2 ... 1.5 mm ² / 0.08 ... 1.5 mm ² / 24 - 16
57 g
12.2 mm / 119.8 mm / 71.5 mm
-25 °C ... 55 °C

Ordering data

Description
1-channel DALI-master , complete with accessories (connection plug and marking field)
- Integrated DALI power supply unit
- Extension for IB IL DALI/PWR-PAC

Type	Order No.	Pcs. / Pkt.
IB IL DALI/PWR-PAC	2897813	1

Ordering data

Type	Order No.	Pcs. / Pkt.
IB IL DALI-PAC	2897910	1

INTERFACE system bus master terminal

The Inline terminal can be used to connect INTERFACE modules to the Inline station and thus the higher-level bus system via the INTERFACE system bus.

Features:

- Easy integration of up to 8 INTERFACE EMM and EEM modules with firmware 1.03 or later
- User-friendly parameterization, configuration, and diagnostics using DTMs (Device Type Managers)
- Serial interface (S port) including a memory stick for saving the configuration
- Acquisition and output of up to 31 measured values and 16 manipulated variables
- Application: motor and energy data management

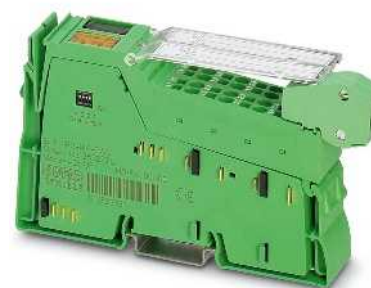
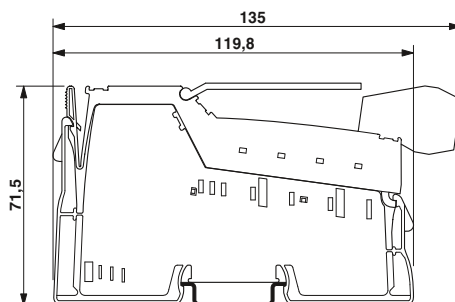

INTERFACE system bus master

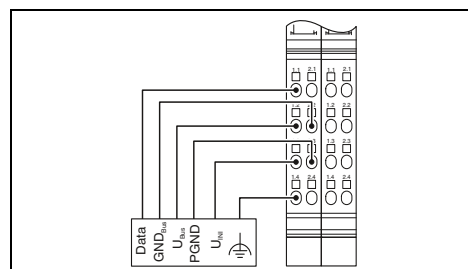

Local bus interface
Connection method
Communication interface
Interface
Connection method
Programming interface
Interface
Connection method
Power supply for module electronics
Communications power U_L
Current consumption from U_L
Supply of the connected INTERFACE modules
9 V supply
Voltage range
Type of protection
Max. current carrying capacity
24 V supply (EEM, EMM)
Voltage range
Type of protection
Max. current carrying capacity
General data
Connection method
Connection data solid / stranded / AWG
Weight
Width
Ambient temperature (operation)

Technical data
Inline data jumper
INTERFACE system bus
Inline shield connector
Programming interface (S port)
IFS-USB-PROG-ADAPTER
7.5 V (via voltage jumper)
typ. 66 mA
8.1 V ... 9.9 V
Short-circuit protection, electronic
300 mA
19.2 V ... 30 V (including ripple)
Short-circuit protection, electronic and thermal
4 A
Spring-cage connection
0.08 ... 1.5 mm ² / 0.08 ... 1.5 mm ² / 28 - 16
130 g
24.4 mm
-25 °C ... 55 °C

Description
Inline Modular communication terminal , complete with accessories (connector plug and marking field)
- For connecting the INTERFACE system bus

Ordering data		
Type	Order No.	Pcs. / Pkt.
IB IL IFS-MA-PAC	2692720	1

Connector set
Programming adapter with USB interface
Multifunctional memory module for the INTERFACE system
Assembled connecting cable, IL-IFS, 2 m in length

Accessories		
IB IL AO/CNT-PLSET	2732664	1
IFS-USB-PROG-ADAPTER	2811271	1
IFS-CONFSTICK	2986122	1
IMC 1,5/ 5-ST-3,81SET IL IFS 2M	1784729	1

CAN master terminal

The Inline terminal can be used to connect a lower-level CAN network. Within the Inline station, the terminal acts as a CAN master for the CAN system.

Any CAN frames with 11-bit or 29-bit identifier can be transmitted via the terminal by the PLC to all types of CAN devices, regardless of the CAN protocol present there.

Features:

- Transparent mode
- CAN 2.0A (11-bit identifier; standard frame)
- CAN 2.0B (29-bit identifier; extended frame)
- Transmission speed of 10 kbps to 1 Mbps
- Maximum data width:
126 bytes + 2-byte command/status word
- User-friendly controller-independent software tool for configuring the CAN network
- Serial interface (S port) including a memory stick for saving the configuration

Notes:

The driver function blocks can be obtained free of charge on the Internet at phoenixcontact.net/products under Download on the product page of the corresponding module.

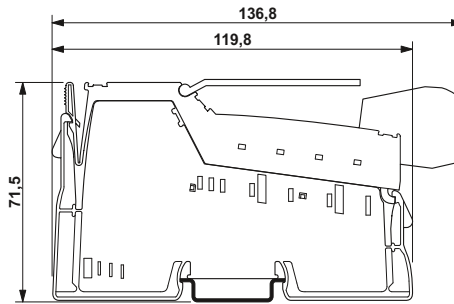

CAN master

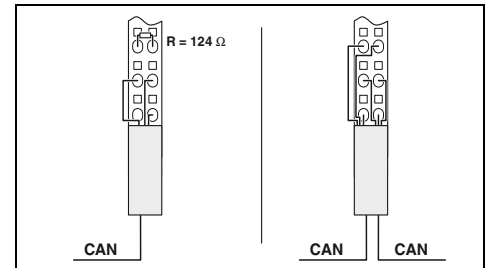

Technical data

Inline data jumper

CAN bus
Inline shield connector

CAN bus
Inline shield connector

7.5 V (via voltage jumper)
typ. 110 mA

Spring-cage connection
0.08 ... 1.5 mm² / 0.08 ... 1.5 mm² / 28 - 16
75 g
12.2 mm
-25 °C ... 55 °C

Ordering data

Type	Order No.	Pcs. / Pkt.
IB IL CAN-MA-PAC	2700196	1
IB IL CAN-MA-XC-PAC	2701160	1

Accessories

IB IL SCN 6-SHIELD-TWIN	2740245	5
IFS-CONFSTICK	2986122	1
IB IL CAN-MA CONF-CAB	2700620	1

Local bus interface
Connection method
Communication interface
Interface
Connection method
Programming interface
Interface
Connection method
Power supply for module electronics
Communications power U_L
Current consumption from U_L
General data
Connection method
Connection data solid / stranded / AWG
Weight
Width
Ambient temperature (operation)

Description
Inline Modular communication terminal , complete with accessories (connector plug and marking field)
- For connecting a CAN bus system
- For extended temperature range of -40°C ... +70°C

Shield connector
Multifunctional memory module for the INTERFACE system
Configuration cable for IB IL CAN-MA-PAC

IO-Link master terminal

The Inline IO-Link master enables the connection of IO-Link-compatible sensors and actuators (IO-Link devices).

Features:

- 4 type A IO-Link ports
- Transmission speeds
 - COM1: 4.8 kBaud
 - COM2: 38.4 kBaud
 - COM3: 230.4 kBaud
- Optional use of the IO-Link ports in SIO mode as standard inputs or standard outputs
- Connections for 12 digital sensors

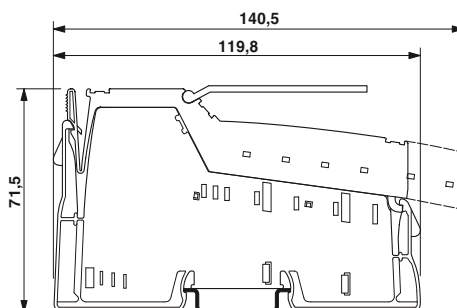

4 IO-Link ports, 12 digital inputs

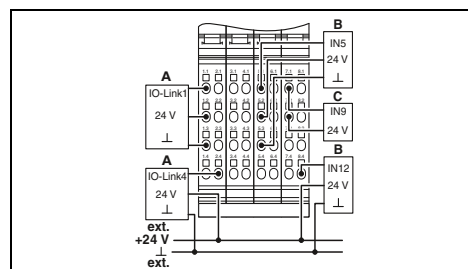
**Technical data**

Local bus interface	
Connection method	Inline data jumper
Power supply for module electronics	
Communications power U_L	7.5 V (via voltage jumper)
Current consumption from U_L	Max. 100 mA
Digital inputs	
Connection technology	2, 3-wire
Number of inputs	12 (EN 61131-2 type 1)
IO-Link ports	
Connection technology	2, 3-wire
Number of ports	4
IO-Link port supply	
I/O supply voltage	min. U_S - 1 V
Nominal current for every IO-Link port	Max. 200 mA
Nominal current per device	Max. 800 mA
Digital inputs in the SIO mode	
Number of inputs	Max. 4
Input voltage	24 V DC
Input voltage range	0 V DC ... 30 V DC
Nominal input current	5.5 mA (at 24 V DC)
Current flow	linear in the range of 0 V ... 7 V, constant in the range of 7 V ... 30 V
Signal delay	3 ms
Digital outputs in the SIO mode	
Number of outputs	Max. 4
Nominal output voltage	U_S - 3 V (U_{OUT} at $I_{OQ} \leq 200$ mA)
Nominal current per channel	Max. 200 mA ($I_{Nominal}$)
Maximum total current consumption	Max. 800 mA
Protective circuit	Short-circuit protection integrated per channel
General data	
Connection method	Spring-cage connection
Connection data solid / stranded / AWG	0.08 ... 1.5 mm ² / 0.08 ... 1.5 mm ² / 28 - 16
Weight	200 g
Width	48.8 mm
Ambient temperature (operation)	-25 °C ... 55 °C
EMC note	Class A product, see page 527

Ordering data

Description	Type	Order No.	Pcs. / Pkt.
Inline IO-Link master , complete with accessories (connector plug and marking field)	IB IL 24 IOL 4 DI 12-PAC	2692717	1

PROFIBUS terminal

The PROFIBUS terminal enables the connection of PROFIBUS modules to a PC Worx controller via INTERBUS or PROFINET.

Likewise, a PC Worx controller can be integrated into an existing PROFIBUS system.

The terminal supports both the master and slave functions.

Features:

- PROFIBUS DP V0 master for a maximum of ten PROFIBUS slaves with up to 48 data words of input and output data
- PROFIBUS DP V0 master for a maximum of three PROFIBUS slaves with up to 56 data words of input and output data
- PROFIBUS DP slave with a maximum of 56 data words
- User-friendly parameterization via PC Worx
- Local plug-in memory for backing up the configuration

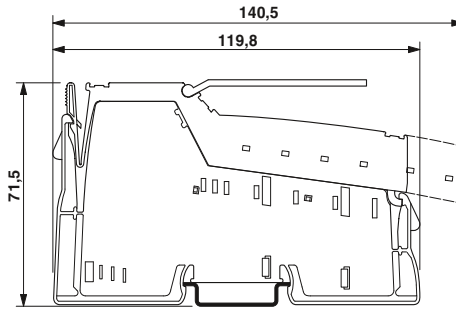

PROFIBUS master/slave

Local bus interface
Connection method
Communication interface
Interface
Connection method
Power supply for module electronics
Communications power U_L
Current consumption from U_L
General data
Connection method
Weight
Width
Ambient temperature (operation)

Technical data	
Inline data jumper	
PROFIBUS DP V0 master/slave	
9-pos. D-SUB socket	
7.5 V (via voltage jumper)	
typ. 98 mA	
9-pos. D-SUB socket	
200 g	
48.8 mm	
-25 °C ... 55 °C	

Description
Inline PROFIBUS master , complete with accessories (connector plug and marking field)

Ordering data		
Type	Order No.	Pcs. / Pkt.
IB IL PB MA-PAC	2700630	1

D-SUB connector , 9-pos. with two cable entries, termination resistor can be switched on via slide switch
--

Accessories		
	Order No.	Pcs. / Pkt.
SUBCON-PLUS-PROFIB	2744348	1

Counter terminal

The Inline counter terminal detects and processes fast pulse sequences from sensors.

Features:

- 1 counter
- 24 V sensor supply including monitoring
- Processing of 5 V or 24 V signals
- Input frequency of up to 100 kHz
- Gate input
- Four operating modes: event counting, time- or state-controlled frequency measurement, time measurement (period or pulse length), and pulse generator
- 24-bit counter value for event counting and frequency measurement
- 16-bit counter value for time measurement
- Time measurement resolutions: 2 μ s, 1 ms, and 10 ms
- Frequency measurement resolution of up to 0.1 Hz
- 24 V onboard output switches when relation condition is met
- Start and final value can be modified during counting

Notes:

The driver function blocks can be obtained free of charge on the Internet at phoenixcontact.net/products under Download on the product page of the corresponding module.

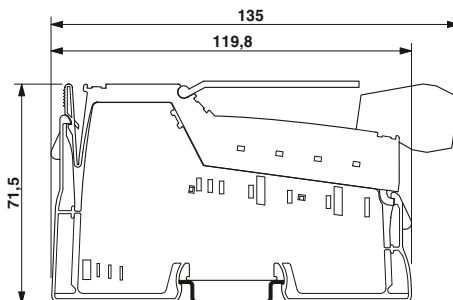

1 counter input

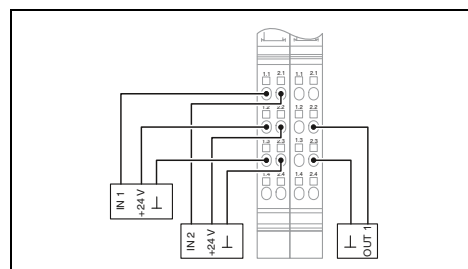

Technical data

Local bus interface	
Connection method	Inline data jumper
Power supply for module electronics	
Supply voltage	24 V DC (via voltage jumper)
Supply voltage range	19.2 V DC ... 30 V DC (including all tolerances, including ripple)
Communications power U_L	7.5 V DC (via voltage jumper)
Current consumption from U_L	typ. 40 mA
Counter input	
Operating modes	Event counting, frequency/time measurement
Input frequency	Max. 100 kHz
Input voltage	24 V DC (nominal voltage) / 30 V DC (maximum)
Input current	typ. 5 mA
Control input	
Connection technology	2, 3-wire
Input voltage	24 V DC (nominal voltage) / 30 V DC (maximum)
Input current	typ. 5 mA
Digital outputs	
Number of outputs	1
Connection technology	2-wire
Output voltage	24 V DC (nominal voltage)
Output current	Max. 0.5 A (nominal current)
General data	
Connection technology	Spring-cage connection
Connection data solid / stranded / AWG	0.08 ... 1.5 mm ² / 0.08 ... 1.5 mm ² / 28 - 16
Weight	130 g
Width	24.4 mm
Ambient temperature (operation)	-25 °C ... 55 °C

Ordering data

Description	Type	Order No.	Pcs. / Pkt.
Inline counter terminal , complete with accessories (connector plug and marking field)	IB IL CNT-PAC	2861852	1
- for extended temperature range of -40°C ... +70°C	IB IL CNT-XC-PAC	2702134	1

Accessories

Connector set	IB IL AO/CNT-PLSET	2732664	1
----------------------	--------------------	---------	---

Pulse width terminal

The Inline PWM terminal outputs signals; depending on the operating mode, either the pulse length, period length or frequency can be set.

Features:

- 2 independent channels
- Output of 5 V or 24 V signals
- Maximum frequency of 50 kHz
- Pulse width modulation (period length can be set in increments from 100 μ s to 10 s, duty factor in 0.39% increments)
- Frequency output (frequency can be set between 0 and 50 kHz)
- Single pulse output (pulse length of 10 μ s to 25.5 s can be set)
- Pulse/direction signal output without integrated ramp function to control step motor power sections

Notes:

The driver function blocks can be obtained free of charge on the Internet at phoenixcontact.net/products under Download on the product page of the corresponding module.

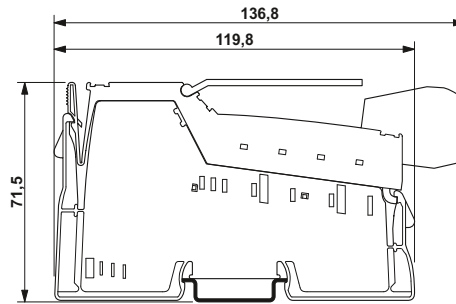

Pulse width modulation, frequency generator or step motor control

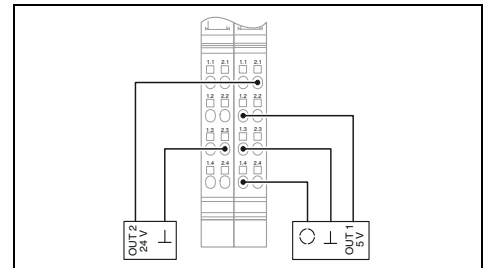

Technical data

Local bus interface	
Connection method	Inline data jumper
Power supply for module electronics	
Supply voltage	24 V DC (via voltage jumper)
Supply voltage range	19.2 V DC ... 30 V DC (including all tolerances, including ripple)
Communications power U_L	7.5 V (via voltage jumper)
Current consumption from U_L	Max. 130 mA
Digital outputs	
Number of outputs	Max. 2
Connection technology	2-wire (shielded)
Output voltage	24 V / 5 V DC
Output current	10 mA (5 V); 500 mA (24 V)
General data	
Connection technology	Spring-cage connection
Connection data solid / stranded / AWG	0.08 ... 1.5 mm ² / 0.08 ... 1.5 mm ² / 28 - 16
Weight	130 g
Width	24.4 mm
Ambient temperature (operation)	-25 °C ... 55 °C

Ordering data

Description	Type	Order No.	Pcs. / Pkt.
Inline function terminal , complete with accessories (connector plug and marking field)	IB IL PWM/2-PAC	2861632	1

Accessories

Connector	Order No.	Pcs. / Pkt.	
Shield connector	IB IL SCN-8	2726337	10
	IB IL SCN 6-SHIELD-TWIN	2740245	5

Power measurement terminal

This module is designed for use within an inline station.

The power measurement terminal enables you to analyze AC networks and is used in applications where conventional analog meters in distribution systems no longer meet growing requirements. This is particularly true in cases where it is important to analyze distortions and harmonics as well as measuring current, voltage, and power.

Features:

- 3 phases plus neutral conductor, connectable
- Direct current detection, 1 A or 5 A
- Line-to-line voltage up to 690 V AC (L-L)
- Specification according to EN 61010-1:2001:
 - Measurement category 3 (300 V AC (L-N))
 - Measurement category 2 (400 V AC (L-N))
- Network variables:
 - Phase currents and neutral conductor current
 - Phase and phase conductor voltages
 - Real, reactive, and apparent powers
 - Power factors of phases
 - Power flow directions
 - Frequency
- Operating modes:
 - Basic measured values
 - Scanning measured values (64 scans/full wave)
- Synchronization
- Triggers for measurement intervals can be freely defined
- Harmonic analysis up to 31st harmonic
- Determination of maximum value
- Operating hours counter
- Power meter
- Bimetal filtering

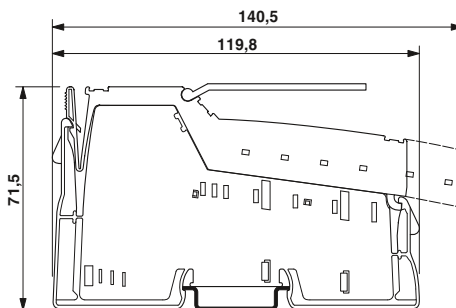

Analysis of AC networks

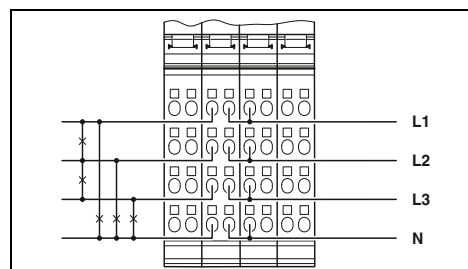

Local bus interface	
Designation	Inline local bus
Connection method	Inline data jumper
Power supply for module electronics	
Communications power U_L	7.5 V (via voltage jumper)
Current consumption from U_L	typ. 130 mA
Current measuring input	
Nominal current I_N	5 A AC (1 A AC, depending on parameterization)
Overload	1.4 times continuous; 150 A for 10 ms
Accuracy	0.25 % (of the nominal value)
Scanning rate	22.4 k samples/50 Hz
Voltage measuring input	
Nominal voltage U_N	400 V AC (nominal phase voltage)
Nominal voltage U_N	0 V AC ... 690 V AC (phase conductor voltage)
Overload	1.2 times the nominal value
Accuracy	0.25 % (of the nominal value)
Scanning rate	22.4 k samples/50 Hz
General data	
Connection method	Spring-cage connection
Connection data solid / stranded / AWG	0.2 ... 1.5 mm ² / 0.2 ... 1.5 mm ² / 24 - 16
Weight	200 g
Width	48.8 mm
Ambient temperature (operation)	-25 °C ... 60 °C

Technical data

Technical data	
Inline local bus	
Inline data jumper	
7.5 V (via voltage jumper)	
typ. 130 mA	
5 A AC (1 A AC, depending on parameterization)	
1.4 times continuous; 150 A for 10 ms	
0.25 % (of the nominal value)	
22.4 k samples/50 Hz	
400 V AC (nominal phase voltage)	
0 V AC ... 690 V AC (phase conductor voltage)	
1.2 times the nominal value	
0.25 % (of the nominal value)	
22.4 k samples/50 Hz	
Spring-cage connection	
0.2 ... 1.5 mm ² / 0.2 ... 1.5 mm ² / 24 - 16	
200 g	
48.8 mm	
-25 °C ... 60 °C	

Description	
Inline power measurement terminal, complete with accessories (connector plug and marking field)	

Marking field, width: 12.2 mm
Marking field, width: 48.8 mm

Ordering data

Type	Order No.	Pcs. / Pkt.
IB IL PM 3P/N/EF-PAC	2700965	1

Accessories

IB IL FIELD 2	2727501	10
IB IL FIELD 8	2727515	10

Position detection terminals

Inline position detection terminals can be used to detect the position with incremental encoders, absolute encoders with SSI interface or magnetostrictive encoders with start/stop interface.

IB IL INC-IN-PAC features:

- Symmetrical and asymmetrical incremental encoders with or without Z trace can be connected
- Shield connection
- Maximum input frequency of 300 kHz
- Single, double or quadruple evaluation
- 25-bit actual position value
- 5 V and 24 V encoder supply including monitoring
- 3 digital inputs to connect two limit switches and one home position switch
- 5 homing functions
- Direction of rotation indicator via LED
- Open circuit detection

IB IL SSI-IN-PAC features:

- 1 single- or multi-turn encoder with up to 25-bit resolution can be connected
- Transmission frequency of up to 1 MHz
- 5 V encoder supply including monitoring
- Gray or binary code
- Parity monitoring
- Reversal of direction of rotation
- Shield connection

IB IL IMPULSE-IN-PAC features:

- 1 magnetostrictive encoder can be connected
- Evaluation of the position of a magnet
- Length measuring range of up to 3.85 m
- Position resolution of 5 μm
- Ultrasonic encoder speed of 2500 m/s to 2999.99 m/s
- 24 V encoder supply including monitoring
- Shield connection

Notes:

The driver function blocks can be obtained free of charge on the Internet at phoenixcontact.net/products under Download on the product page of the corresponding module.

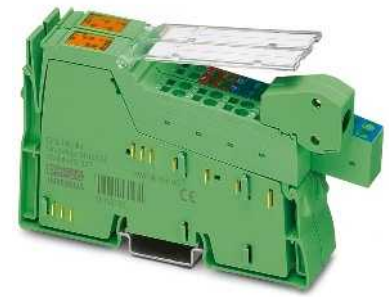
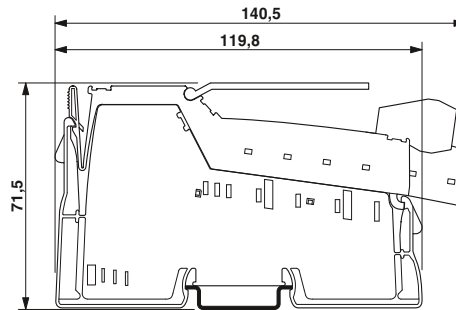

Input for incremental encoder with square-wave signal (symmetrical or asymmetrical)

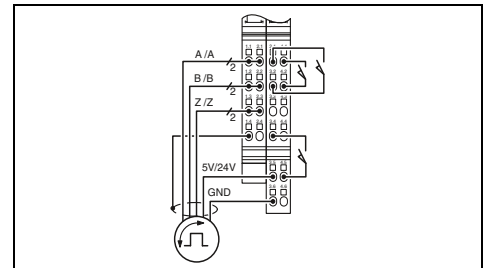

Local bus interface	
Connection method	Inline data jumper
Power supply for module electronics	
Communications power U_L	7.5 V (via voltage jumper)
Current consumption from U_L	Max. 70 mA
Encoder supply voltage	5 V DC / 24 V DC
Encoder supply current	Max. 250 mA
Drawing encoder supply voltage	Main circuit U_M
Drawing initiator supply	Main circuit U_M
Incremental encoder input	
Number of inputs	1
Description of the input	Symmetrical (RS-422) or asymmetrical (3.5 V - 27 V)
Input frequency (24 V)	0 Hz ... 300 kHz
Absolute position encoder input	
Number of inputs	-
Transmission frequency	-
Adjustable resolution	-
Input for magnetostrictive encoders	
Length measuring range	-
Ultrasound speed (gradient)	-
Digital inputs	
Number of inputs	3
Input voltage range "0" signal	-30 V DC ... 5 V DC
Input voltage range "1" signal	15 V DC ... 30 V DC
General data	
Connection method	Spring-cage connection
Connection data solid / stranded / AWG	0.08 ... 1.5 mm ² / 0.08 ... 1.5 mm ² / 28 - 16
Weight	143 g
Width	24.4 mm
Ambient temperature (operation)	-25 °C ... 55 °C

Technical data		
Inline data jumper		
7.5 V (via voltage jumper)		
Max. 70 mA		
5 V DC / 24 V DC		
Max. 250 mA		
Main circuit U_M		
Main circuit U_M		
1		
Symmetrical (RS-422) or asymmetrical (3.5 V - 27 V)		
0 Hz ... 300 kHz		
-		
-		
-		
-		
-		
-		
3		
-30 V DC ... 5 V DC		
15 V DC ... 30 V DC		
Spring-cage connection		
0.08 ... 1.5 mm ² / 0.08 ... 1.5 mm ² / 28 - 16		
143 g		
24.4 mm		
-25 °C ... 55 °C		

Inline position detection terminal, complete with accessories (connector plug and marking field)

Ordering data		
IB IL INC-IN-PAC	2861755	1

Connector plug
Shield connector for analog Inline terminals

Accessories		
IB IL SCN-12-ICP	2727611	10
IB IL SCN-6 SHIELD	2726353	5



Input for absolute rotation or travel measuring systems with SSI interface



Input for magnetostrictive encoder with start/stop interface

Ex:

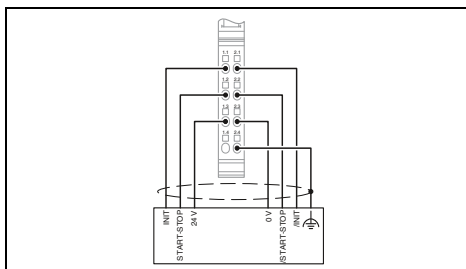
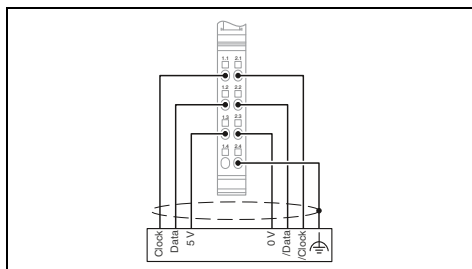

Technical data	
Inline data jumper	
7.5 V (via voltage jumper)	
Max. 28 mA	
5 V DC	
Max. 250 mA	
Main circuit U _M	
-	
-	
-	
1	
100 kHz / 200 kHz / 400 kHz / 800 kHz / 1 MHz	
25 Bit (maximum)	
-	
-	
-	
Spring-cage connection	
0.08 ... 1.5 mm ² / 0.08 ... 1.5 mm ² / 28 - 16	
71 g	
12.2 mm	
-25 °C ... 55 °C	

Technical data	
Inline data jumper	
7.5 V	
Max. 70 mA	
24 V	
Max. 250 mA	
Main circuit U _M	
-	
-	
-	
-	
-	
-	
-	
-	
-	
-	
Spring-cage connection	
0.08 ... 1.5 mm ² / 0.08 ... 1.5 mm ² / 28 - 16	
71 g	
12.2 mm	
-25 °C ... 55 °C	

Ordering data		
IB IL SSI-IN-PAC	2819574	1
Accessories		
IB IL SCN-6 SHIELD	2726353	5

Ordering data		
IB IL IMPULSE-IN-PAC	2861768	1
Accessories		
IB IL SCN-6 SHIELD	2726353	5

Positioning control terminals

The Inline positioning control system is suitable for point-to-point positioning of binary-controlled drives, e.g., pole-changing AC motors, according to the rapid motion/creeping motion principle and supports the positioning of rotary and linear axes.

It can be used to perform simple positioning tasks, such as positioning:

- Transportation equipment
- Format adjustments (adjustable axes)
- Tools

It is not necessary to set control parameters here. After specifying a target position, the terminal automatically, and therefore independently of the bus, assumes control of the drive by specifying both the traversing rate (rapid motion/creeping motion) and the traversing direction via four binary outputs and signaling when the target point has been reached.

Features:

- Position detection using absolute encoders with SSI interface
- 5 V and 24 V encoder supply including monitoring
- 24 V sensor supply including monitoring
- 3 digital inputs
- 4 digital outputs
- Software limit switch
- Integrated monitoring functions
- Gear ratio can be parameterized
- Backlash and friction compensation
- Startup using hand-held operator panel mode

Notes:

The driver function blocks can be obtained free of charge on the Internet at phoenixcontact.net/products under Download on the product page of the corresponding module.

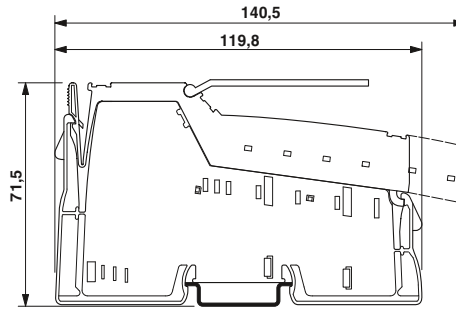

SSI interface for absolute encoders

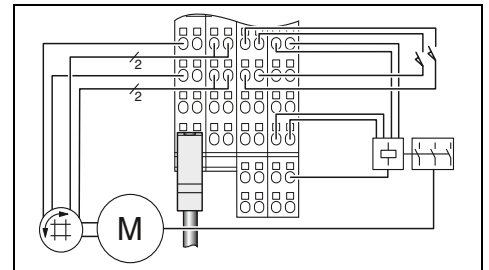

Local bus interface	
Connection method	Inline data jumper
Power supply for module electronics	
Communications power U_L	7.5 V (via voltage jumper)
Current consumption from U_L	Max. 60 mA
Encoder supply voltage	5 V DC / 24 V DC
Encoder supply current	500 mA
Drawing encoder supply voltage	Main circuit U_M
Drawing initiator supply	Main circuit U_M
Absolute position encoder input	
Number of inputs	1
Transmission frequency	400 kHz
Adjustable resolution	26 Bit (maximum)
Digital inputs	
Number of inputs	3
Input voltage range "0" signal	-30 V DC ... 5 V DC
Input voltage range "1" signal	13 V DC ... 30 V DC
Digital outputs	
Number of outputs	4
Output voltage	24 V DC
Output current	2 A
General data	
Connection method	Spring-cage connection
Connection data solid / stranded / AWG	0.08 ... 1.5 mm ² / 0.08 ... 1.5 mm ² / 28 - 16
Weight	210 g
Width	48.8 mm
Ambient temperature (operation)	-25 °C ... 55 °C

Technical data

Technical data	
Inline data jumper	
7.5 V (via voltage jumper)	
Max. 60 mA	
5 V DC / 24 V DC	
500 mA	
Main circuit U_M	
Main circuit U_M	
1	
400 kHz	
26 Bit (maximum)	
3	
-30 V DC ... 5 V DC	
13 V DC ... 30 V DC	
4	
24 V DC	
2 A	
Spring-cage connection	
0.08 ... 1.5 mm ² / 0.08 ... 1.5 mm ² / 28 - 16	
210 g	
48.8 mm	
-25 °C ... 55 °C	

Inline positioning terminal , complete with accessories (connector plug and marking field) - Absolute encoder input

Ordering data

IB IL SSI-PAC	2861865	1
----------------------	----------------	---

Connector plug Shield connector for analog Inline terminals

Accessories

IB IL SCN-12-ICP	2727611	10
IB IL SCN-6 SHIELD	2726353	5

Servo controller for EC motors

The IB IL EC AR 48/10A Inline servo controller is a universal power output module with a 4 quadrant function for permanently excited DC motors with brushgears or electronically commutated DC motors (EC motors) with up to 450 W power output.

Features:

- Variable frequency drive with positioning function
- Electronic commutation with Hall sensors
- Point-to-point positioning function
- Speed profile: Trapezoid or S curve
- Position, speed, and torque control
- Position detection with incremental encoder
- Homing
- Max. 48 V/10 A
- 97.6 mm overall width
- Software tool for operation and startup including oscilloscope function
- Cycle time of the position controller: 1 ms
- For single- and multi-axis applications

Applications:

- Handling machines in the semiconductor industry, in small parts protection, in the electronics industry, and in test engineering
- Assembly machines in small appliance production
- Bearing and conveying technology for small loads
- Format adjustment in processing machines and packaging machines
- Laboratory technology

Notes:

The driver function blocks can be obtained free of charge on the Internet at phoenixcontact.net/products under Download on the product page of the corresponding module.

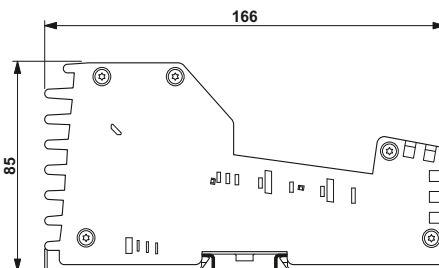

Servo controller for 24 V motors with positioning and homing function

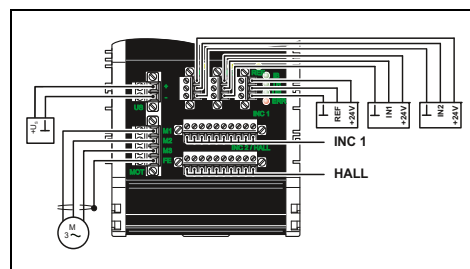

Technical data

Interface	Inline data jumper RS-232
Power supply for module electronics	7.5 V DC (via voltage jumper) typ. 30 mA
Power supply	2-pos. COMBICON connector 12 V DC ... 48 V DC $\pm 15\%$ (surge voltage shutdown $U_S > 60$ V DC)
Motor output	1 permanently excited DC motor with or without brushgear
Connection method	4-pos. COMBICON connector with shield connection clamp
Nominal current range	Max. 10 A (starting/continuous current)
Nominal motor power	450 W (power consumption)
Function	4 quadrant servo controller
Incremental encoder input	Max. 1 MHz
Symmetrical incremental encoders	Max. 500 kHz (at 4 V voltage level) / Max. 100 kHz (at 20 V voltage level)
Input frequency (5 V)	
Asymmetrical incremental encoders	
Input frequency (5 V) / Input frequency (24 V)	
Digital inputs	3
Number of inputs	MINI COMBICON
Connection method	3-wire (signal, Us, GND)
Connection technology	
General data	
Connection method	Screw connection
Connection data solid / stranded / AWG Front MSTB	0.2 ... 2.5 mm ² / 0.2 ... 2.5 mm ² / 24 - 12
Connection data solid / stranded / AWG Front MC	0.14 ... 2.5 mm ² / 0.2 ... 2.5 mm ² / 28 - 16
Weight	880 g
Width	97.6 mm
Ambient temperature (operation)	-25 °C ... 55 °C
EMC note	Class A product, see page 527

Ordering data

Description	Type	Order No.	Pcs. / Pkt.
Inline variable frequency drive , including connector plug			
- For DC motors with brushgear and EC motors (without brushgear)	IB IL EC AR 48/10A-PAC	2819587	1

Power-level terminals

The single-channel power-level terminals for direct and reversing starters and the electromechanical version with electronic motor protection enable a three-phase asynchronous motor to be switched, protected, and monitored via a bus system.

The power-level terminals are designed for use within the 24 V area of an Inline station.

Features:

- Integrated electronic motor protection according to IEC 60947-4
- Connection option for an external passive brake module
- Manual local operation
- Safe isolation between mains voltage and 24 V supply voltage according to EN 50178
- Diagnostic and status indicators
- Motor current monitoring
- Motor control via OUT process data

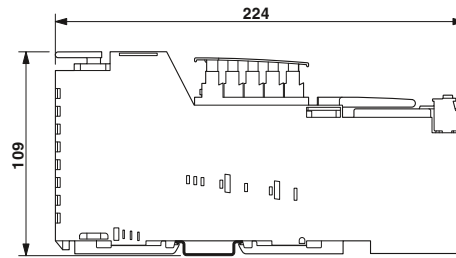

Electronic direct or reversing load starter, up to 1.5 kW/400 V AC

ERC

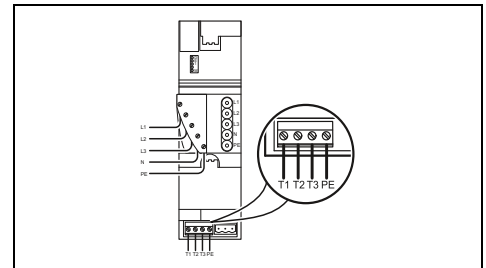

Interface	
Inline local bus	
Power supply for module electronics	
Communications power U_L	
Current consumption from U_L	
Motor starter, output	
Connection method	
Output voltage range	
Nominal current range	
Power factor	
Switching rate	
Motor monitoring	
Tripping class	
Overspeed tripping	
Output	
Maximum switching voltage	-
Max. switching current	-
Switch-off delay	-
Switch-on delay	-
General data	
Connection method	Screw connection
Connection data solid / stranded / AWG Motor circuit connector	0.2 ... 1.5 mm ² / 0.2 ... 1.5 mm ² / 24 - 16
Width	63 mm
EMC note	Class A product, see page 527

Technical data		
Inline data jumper		
7.5 V		
Max. 45 mA		
(3-phase), via COMBICON		
200 V AC ... 400 V AC (50 Hz ... 60 Hz)		
0.2 A ... 3.6 A		
0.3		
Max. 30 per minute (observe derating)		
Based on class 10 A of IEC 60947-4: 1990		
≥ 20 A (after 0.3 seconds)		
-		
-		
-		
-		
Screw connection		
0.2 ... 1.5 mm ² / 0.2 ... 1.5 mm ² / 24 - 16		
63 mm		
Class A product, see page 527		

Description
Inline power-level terminals , incl. motor circuit connector
- Electronic direct starter
- Electronic reversing load starter
- Electromechanical direct starter
Inline brake module , for brake control in connection with Inline power-level terminals
- For 440 V AC/DC brakes

Ordering data		
Type	Order No.	Pcs. / Pkt.
IB IL 400 ELR 1-3A	2727352	1
IB IL 400 ELR R-3A	2727378	1

Inline thermistor terminal , complete with accessories (connector plug and marking field)
Hand-held operator panel , for motor starters and variable frequency drives
Power connector for Inline power-level terminals
Power bridge , for Inline power-level terminals
Motor-circuit connector for Inline power-level terminals

Accessories		
IB IL 24 TC-PAC	2861360	1
IBS HVO	2836052	1
IB IL 400 CN-PWR-IN	2836078	1
IB IL 400 CN-BRG	2836081	1
GMVSTBW 2,5 HV/ 4-ST-7,62 NZIL	1893957	10



Electronic direct starter, up to 3.7 kW/400 V AC



Extension module, for brake control of power-level terminals

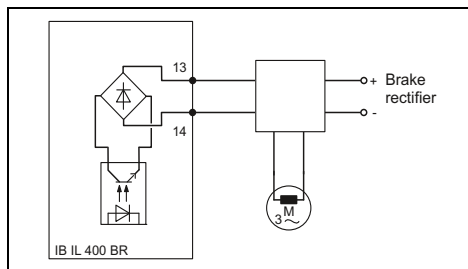
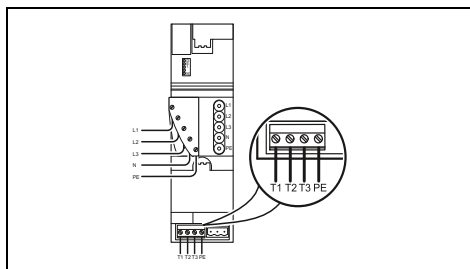

Technical data
Inline data jumper
7.5 V
Max. 45 mA
(3-phase), via COMBICON
200 V AC ... 600 V AC (50 Hz ... 60 Hz)
0.2 A ... 8 A
0.3
Max. 5 cycles per minute
Based on class 10 A of IEC 60947-4: 1990
≥ 40 A (after 0.3 seconds)
-
-
-
-
Screw connection
0.2 ... 1.5 mm ² / 0.2 ... 1.5 mm ² / 24 - 16
63 mm
Class A product, see page 527

Technical data
-
-
-
-
-
-
-
-
-
440 V AC/DC
300 mA AC/DC
< 1 ms
< 4 ms
-
-
55 mm
Class A product, see page 527

Ordering data		
Type	Order No.	Pcs. / Pkt.
IB IL 400 MLR 1-8A	2727365	1

Ordering data		
Type	Order No.	Pcs. / Pkt.
IB IL 400 BR	2727394	1

Accessories		
IB IL 24 TC-PAC	2861360	1
IBS HVO	2836052	1
IB IL 400 CN-PWR-IN	2836078	1
IB IL 400 CN-BRG	2836081	1
GMVSTBW 2,5 HV/ 4-ST-7,62 NZIL	1893957	10

Accessories		

Inline Block IO



The space-saving extension for modular Inline I/O modules: compact and flat Inline Block IO modules. Pre-assembled devices with a block design can be used to integrate a fixed number of I/Os into your network or bus system. Significant benefits can be achieved in terms of handling and costs for low numbers of I/Os in particular, as I/O modules and bus couplers are combined in a single device.

Your advantages:

- Particularly space saving: just 55 mm tall and 95 or 156 mm wide
- Manage low numbers of I/Os cost-effectively
- Time savings as no configuration is required and installation is easy
- Separate module, sensor, and actuator supply increases system availability

Find out more with the web code

Detailed information on these products can be found on our website. Simply enter # and numbers in the search field.

 Your web code: #0285



Distributed I/O system with a block design

Description
Inline Block IO digital I/O module for Modbus/TCP - 16 fixed inputs, 16 freely selectable inputs/outputs
Inline Block IO digital I/O module for PROFINET - 16 fixed inputs, 16 freely selectable inputs/outputs
Inline Block IO analog and digital I/O module and motion control for Sercos - 2 axes, drive control via speed setpoint, position detection with incremental signal from rotary/linear encoder
Inline Block IO digital I/O module for CANopen® - 16 inputs, 16 outputs
Inline Block IO digital I/O module for DeviceNet™ - 16 inputs, 16 outputs
Inline Block IO analog and digital I/O modules for INTERBUS - 4 analog inputs, 2 analog outputs - 16 inputs - 32 inputs - 16 outputs - 32 outputs - 8 inputs, 8 outputs - 16 inputs, 16 outputs - 16 inputs, 16 outputs, D-SUB bus connection
Inline Block IO analog and digital I/O modules for PROFIBUS - 4 analog inputs, 2 analog outputs - 8 inputs, 8 inputs or outputs - 16 inputs, 16 outputs - 32 inputs - 32 outputs

Ordering data		
Type	Order No.	Pcs. / Pkt.
ILB ETH 24 DI16 DIO16-2TX	2832962	1
ILB PN 24 DI16 DIO16-2TX	2878146	1
ILB S3 24 DI8 DO4 AO2 INC-IN2	2700174	1
ILB CO 24 DI16 DO16	2862592	1
ILB DN 24 DI16 DO16	2862602	1
ILB IB A14 AO2	2878777	1
ILB IB 24 DI16	2862330	1
ILB IB 24 DI32	2862343	1
ILB IB 24 DO16	2862356	1
ILB IB 24 DO32	2862369	1
ILB IB 24 DI 8 DO 8	2862372	1
ILB IB 24 DI16 DO16	2862385	1
ILB IB 24 DI16 DO16-DSUB	2878625	1
ILB PB A14 AO2	2878874	1
ILB PB 24 DI 8 DIO8	2863562	1
ILB PB 24 DI16 DO16	2862411	1
ILB PB 24 DI32	2862398	1
ILB PB 24 DO32	2862408	1

INTERBUS ST



INTERBUS ST (Smart Terminal) modules are used for medium to high numbers of I/Os – they connect sensors and actuators to INTERBUS, either distributed in the terminal box or centrally in the control cabinet.

Your advantages:

- Different connection methods increase flexibility when selecting the transmission medium
- Replaceable module electronics ensure reliable operation
- Adaptation to your individual needs, thanks to the modular design and connecting the modules as desired

Find out more with the web code

Detailed information on these products can be found on our website. Simply enter # and numbers in the search field.

i Your web code: **#0286**



Distributed I/O system with a modular design

Description	Ordering data		
	Type	Order No.	Pcs. / Pkt.
INTERBUS ST BK modules - D-SUB connector, 9-pos. - MINI-COMBICON connector, 8-pos. - Fiber optic F-SMA connector, optical path diagnostics - Additional remote bus branch, D-SUB connector - Additional local bus branch - D-SUB connector, 9-pos., 8 digital inputs and outputs each	IBS ST 24 BK-T	2754341	1
	IBS ST 24 BKM-T	2750154	1
	IBS ST 24 BKM-LK-OPC	2728665	1
	IBS ST 24 BK RB-T	2753504	1
INTERBUS ST digital modules - 16 inputs - 32 inputs - 32 outputs - 16 relay N/O contact outputs - 8 inputs, 8 outputs, 2 A	IB ST 24 BK LB-T	2753232	1
	IBS ST 24 BK DIO 8/8/3-T	2752411	1
	IB ST 24 DI 16/4	2754338	1
	IB ST 24 DI32/2	2754927	1
	IB ST 24 DO32/2	2754325	1
	IB ST 24 DO16R/S	2721112	1
IB ST 24 DIO 8/8/3-2A	2753708	1	
INTERBUS ST analog modules - 4 inputs, 0 - 20 mA, 4 - 20 mA, 0 - 10 V, ±10 V - 8 inputs, 0 - 20 mA, 4 - 20 mA, 0 - 10 V, etc.	IB ST 24 AI 4/EF	2700838	1
	IB ST 24 BAI 8/EF	2700842	1
- 4 inputs, RTD, Pt 100, Pt 1000, etc. - 4 outputs, 0 - 20 mA, 4 - 20 mA, 0 - 10 V	IB ST 24 TEMP 4 RTD	2700843	1
	IB ST 24 AO 4/EF	2700839	1

Product overview

Axioline I/O modules, metal, M12



	Digital input	Digital input/output		IO-Link
	16 channels	16 freely configurable channels	8/8 channels	8/4 channels
EtherCAT	Page 226			Page 227
EtherNet/IP	Page 228			Page 229
Modbus/TCP (UDP)	Page 230			Page 231
PROFINET	Page 232			Page 233
Sercos	Page 234			Page 235
PROFIBUS	Page 236			Page 237

Axioline I/O modules, plastic, M12



	Digital input	Digital input/output		IO-Link
	16 channels	16 freely configurable channels	8/8 channels	8/4 channels
EtherCAT	Page 226			Page 227
EtherNet/IP	Page 228			Page 229
Modbus/TCP (UDP)	Page 230			Page 231
PROFINET	Page 232			Page 233
Sercos	Page 234			Page 235
PROFIBUS	Page 236			Page 237

Axioline M12 I/O-Link devices



IO-Link

Analog input		Analog output		Temperature recording
1 channel Current input	1 channel Voltage input	1 channel Current output	1 channel Voltage output	1 channel RTD
Page 238		Page 239		

Axioline M12 I/O-Link devices



IO-Link

Analog input		Analog output		Temperature recording
1 channel Current input	1 channel Voltage input	1 channel Current output	1 channel Voltage output	1 channel RTD
Page 238		Page 239		

General technical data

Ambient conditions

Temperature range (operation)	-25°C ... +60°C
Permissible humidity (storage/transport)	95%
Vibration	5g according to EN 60068-2-6
Shock	30g according to EN 60068-2-27
Continuous shock	10g according to EN 60068-2-29
Degree of protection	IP65/IP67 according to IEC 60529

Electromagnetic compatibility

Noise emission	Class A according to DIN EN 55022
----------------	-----------------------------------

Supply voltage

Nominal value	24 V DC
Permissible range	18 V DC ... 31.2 V DC, including ripple

For field installation (IP67) – Axioline E

EtherCAT® Digital I/O devices – stand-alone

The I/O devices with a block design are used to acquire and output various signals.

Features:

- Robust metal or plastic housing
- Seamless connection via M12 connectors
- SPEEDCON fast locking system
- Maximum current carrying capacity of the supply 12 A
- Diagnostic and status indicators
- Short-circuit and overload protection

Additional features

IO-Link master:

- According to specification 1.1
- 4 digital inputs, 4 IO-Link ports Class A, 4 IO-Link ports Class B on one device

EtherCAT®
Technology Group



16 digital inputs

EtherCAT®
Technology Group



16 freely configurable inputs or outputs

Ex:

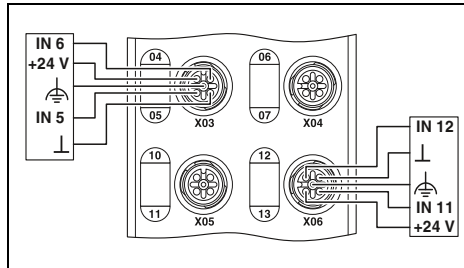

Ex:

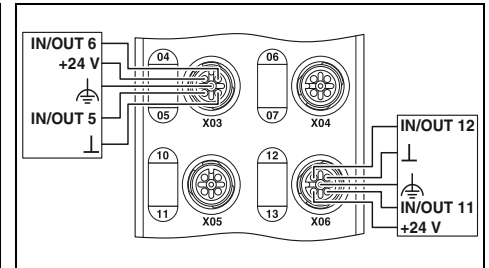

Technical data

AXL E EC DI16 M12 6M AXL E EC DI16 M12 6P

EtherCAT®

M12 connectors, D-coded
100 Mbps (with auto negotiation)

24 V DC

18 V DC ... 31.2 V DC (including all tolerances, including ripple)

M12 connector (T-coded)

M12 connector, double occupancy

2, 3, 4-wire

16 (EN 61131-2 types 1 and 3)

< 1000 µs

Overload protection, short-circuit protection of sensor supply

Technical data

AXL E EC DIO16 M12 6M AXL E EC DIO16 M12 6P

EtherCAT®

M12 connectors, D-coded
100 Mbps (with auto negotiation)

24 V DC

18 V DC ... 31.2 V DC (including all tolerances, including ripple)

M12 connector (T-coded)

M12 connector, double occupancy

2, 3, 4-wire

16 (EN 61131-2 types 1 and 3)

< 1000 µs

Overload protection, short-circuit protection of sensor supply

M12 connector, double occupancy

2, 3-wire

16

0.5 A

Overload protection, short-circuit protection of outputs

Interface	
Fieldbus system	
Connection method	
Transmission speed	
Power supply for module electronics	
Supply voltage	
Supply voltage range	
Connection method	
Digital inputs	
Connection method	
Connection technology	
Number of inputs	
Input filter time	
Protective circuit	
Digital outputs	
Connection method	
Connection technology	
Number of outputs	
Maximum output current per channel	
Protective circuit	
IO-Link ports	
Connection method	
Connection technology	
Number of ports	
IO-Link port supply	
I/O supply voltage	
Nominal current for every IO-Link port	
Protective circuit	
General data	
Weight	
Drill hole spacing	
Dimensions	W / H / D
Degree of protection	
Ambient temperature (operation)	
EMC note	

	AXL E EC DI16 M12 6M	AXL E EC DI16 M12 6P
	EtherCAT®	
	M12 connectors, D-coded 100 Mbps (with auto negotiation)	
	24 V DC	
	18 V DC ... 31.2 V DC (including all tolerances, including ripple)	
	M12 connector (T-coded)	
	M12 connector, double occupancy	
	2, 3, 4-wire	
	16 (EN 61131-2 types 1 and 3)	
	< 1000 µs	
	Overload protection, short-circuit protection of sensor supply	
	750 g	480 g
	198.5 mm	
	60 mm / 185 mm / 38 mm	60 mm / 185 mm / 30.5 mm
	IP65/IP67	
	-25 °C ... 60 °C	
	Class A product, see page 527	

	AXL E EC DIO16 M12 6M	AXL E EC DIO16 M12 6P
	EtherCAT®	
	M12 connectors, D-coded 100 Mbps (with auto negotiation)	
	24 V DC	
	18 V DC ... 31.2 V DC (including all tolerances, including ripple)	
	M12 connector (T-coded)	
	M12 connector, double occupancy	
	2, 3-wire	
	16	
	0.5 A	
	Overload protection, short-circuit protection of outputs	
	750 g	480 g
	198.5 mm	
	60 mm / 185 mm / 38 mm	60 mm / 185 mm / 30.5 mm
	IP65/IP67	
	-25 °C ... 60 °C	
	Class A product, see page 527	

Ordering data

Description	Type	Order No.	Pcs. / Pkt.
Axioline I/O device			
- Robust metal housing	AXL E EC DI16 M12 6M	2701526	1
- Plastic housing	AXL E EC DI16 M12 6P	2701521	1

Ordering data

Description	Type	Order No.	Pcs. / Pkt.
Axioline I/O device			
- Robust metal housing	AXL E EC DIO16 M12 6M	2701528	1
- Plastic housing	AXL E EC DIO16 M12 6P	2701522	1



8 digital inputs and 8 digital outputs



8 digital inputs and 4 digital outputs



8 IO-Link ports, 4 digital inputs

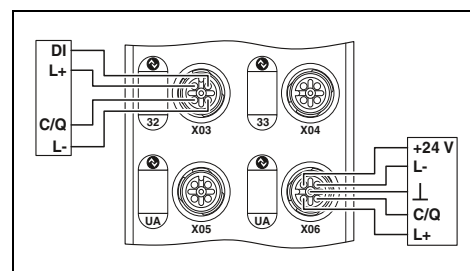
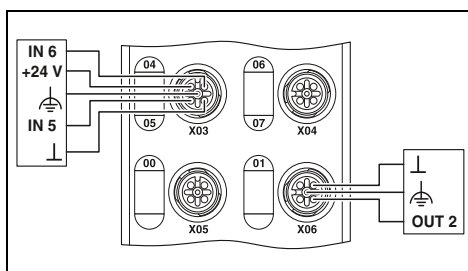
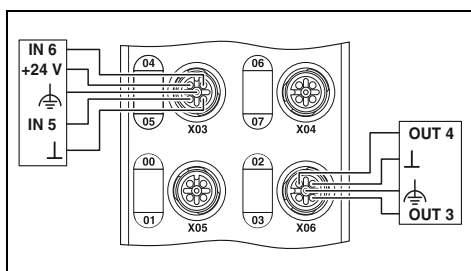

Technical data

AXL E EC DI8 DO8 M12 6M AXL E EC DI8 DO8 M12 6P

EtherCAT®
M12 connectors, D-coded
100 Mbps (with auto negotiation)

24 V DC
18 V DC ... 31.2 V DC (including all tolerances, including ripple)

M12 connector (T-coded)

M12 connector, double occupancy

2, 3, 4-wire

8 (EN 61131-2 types 1 and 3)

< 1000 µs

Overload protection, short-circuit protection of sensor supply

M12 connector, double occupancy

2, 3-wire

8

500 mA

Overload protection, short-circuit protection of outputs

-

-

-

-

-

-

750 g

198.5 mm

480 g

60 mm / 185 mm / 38 mm 60 mm / 185 mm / 30.5 mm

IP65/IP67

-25 °C ... 60 °C

Class A product, see page 527

Ordering data

Type	Order No.	Pcs. / Pkt.
AXL E EC DI8 DO8 M12 6M	2701525	1
AXL E EC DI8 DO8 M12 6P	2701520	1

Technical data

AXL E EC DI8 DO4 2A M12 6M AXL E EC DI8 DO4 2A M12 6P

EtherCAT®
M12 connectors, D-coded
100 Mbps (with auto negotiation)

24 V DC
18 V DC ... 31.2 V DC (including all tolerances, including ripple)

M12 connector (T-coded)

M12 connector, double occupancy

2, 3, 4-wire

8 (EN 61131-2 types 1 and 3)

< 1000 µs

Overload protection, short-circuit protection of sensor supply

M12 connector (A-coded)

2, 3-wire

4

2 A

Overload protection, short-circuit protection of outputs

-

-

-

-

-

-

750 g

198.5 mm

480 g

60 mm / 185 mm / 38 mm 60 mm / 185 mm / 30.5 mm

IP65/IP67

-25 °C ... 60 °C

Class A product, see page 527

Ordering data

Type	Order No.	Pcs. / Pkt.
AXL E EC DI8 DO4 2A M12 6M	2701529	1
AXL E EC DI8 DO4 2A M12 6P	2701523	1

Technical data

AXL E EC IOL8 DI4 M12 6M AXL E EC IOL8 DI4 M12 6P

EtherCAT®
M12 connectors, D-coded
100 Mbps (with auto negotiation)

24 V DC
18 V DC ... 31.2 V DC (including all tolerances, including ripple)

M12 connector (T-coded)

M12 connector, double occupancy

2, 3, 4-wire

4 (EN 61131-2 type 1)

< 1000 µs

Protection against polarity reversal

-

-

-

-

-

M12 connector

3, 5-wire

8

24 V DC

200 mA (during startup, up to 1.6 A for short periods)

Overload protection, electronics in the device

750 g

198.5 mm

480 g

60 mm / 185 mm / 38 mm 60 mm / 185 mm / 30.5 mm

IP65/IP67

-25 °C ... 60 °C

Class A product, see page 527

Ordering data

Type	Order No.	Pcs. / Pkt.
AXL E EC IOL8 DI4 M12 6M	2701531	1
AXL E EC IOL8 DI4 M12 6P	2701524	1

For field installation (IP67) – Axioline E

EtherNet/IP™

Digital I/O devices – stand-alone

The I/O devices with a block design are used to acquire and output various signals.

Features:

- Robust metal or plastic housing
- Seamless connection via M12 connectors
- SPEEDCON fast locking system
- Maximum current carrying capacity of the supply 12 A
- Diagnostic and status indicators
- Short-circuit and overload protection

Additional features

IO-Link master:

- According to specification 1.1
- 4 digital inputs, 4 IO-Link ports Class A, 4 IO-Link ports Class B on one device



16 digital inputs



16 freely configurable inputs or outputs

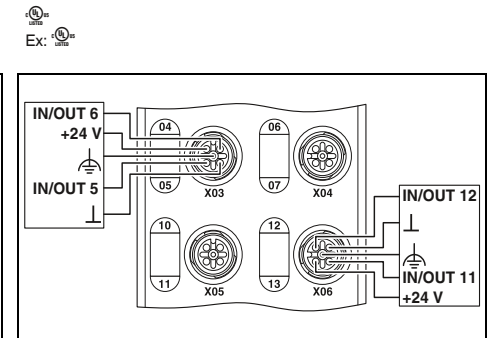
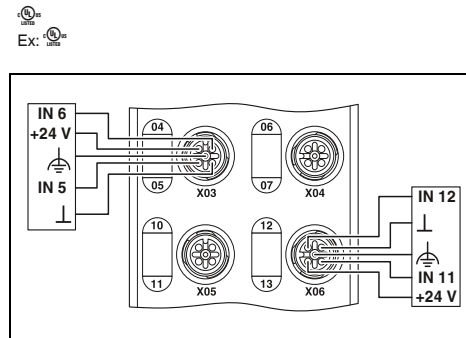

Technical data

AXL E EIP DI16 M12 6M AXL E EIP DI16 M12 6P

EtherNet/IP™

M12 connectors, D-coded
10/100 Mbps (with auto negotiation)

24 V DC

18 V DC ... 31.2 V DC (including all tolerances, including ripple)

M12 connector (T-coded)

M12 connector, double occupancy

2, 3, 4-wire

16 (EN 61131-2 types 1 and 3)

< 1000 µs

Overload protection, short-circuit protection of sensor supply

Technical data

AXL E EIP DIO16 M12 6M AXL E EIP DIO16 M12 6P

EtherNet/IP™

M12 connectors, D-coded
10/100 Mbps (with auto negotiation)

24 V DC

18 V DC ... 31.2 V DC (including all tolerances, including ripple)

M12 connector (T-coded)

M12 connector, double occupancy

2, 3, 4-wire

16 (EN 61131-2 types 1 and 3)

< 1000 µs

Overload protection, short-circuit protection of sensor supply

M12 connector, double occupancy

2, 3-wire

16

0.5 A

Overload protection, short-circuit protection of outputs

Interface	
Fieldbus system	
Connection method	
Transmission speed	
Power supply for module electronics	
Supply voltage	
Supply voltage range	
Connection method	
Digital inputs	
Connection method	
Connection technology	
Number of inputs	
Input filter time	
Protective circuit	
Digital outputs	
Connection method	
Connection technology	
Number of outputs	
Maximum output current per channel	
Protective circuit	
IO-Link ports	
Connection method	
Connection technology	
Number of ports	
IO-Link port supply	
I/O supply voltage	
Nominal current for every IO-Link port	
Protective circuit	
General data	
Weight	
Drill hole spacing	
Dimensions	W / H / D
Degree of protection	
Ambient temperature (operation)	
EMC note	

	750 g	480 g
	198.5 mm	
	60 mm / 185 mm / 38 mm	60 mm / 185 mm / 30.5 mm
	IP65/IP67	
	-25 °C ... 60 °C	
	Class A product, see page 527	

	750 g	480 g
	198.5 mm	
	60 mm / 185 mm / 38 mm	60 mm / 185 mm / 30.5 mm
	IP65/IP67	
	-25 °C ... 60 °C	
	Class A product, see page 527	

Ordering data

Description	Type	Order No.	Pcs. / Pkt.
Axioline I/O device			
- Robust metal housing	AXL E EIP DI16 M12 6M	2701488	1
- Plastic housing	AXL E EIP DI16 M12 6P	2701493	1

Ordering data

Description	Type	Order No.	Pcs. / Pkt.
Axioline I/O device			
- Robust metal housing	AXL E EIP DIO16 M12 6M	2701489	1
- Plastic housing	AXL E EIP DIO16 M12 6P	2701494	1



8 digital inputs and 8 digital outputs



8 digital inputs and 4 digital outputs



8 IO-Link ports, 4 digital inputs

Ex:

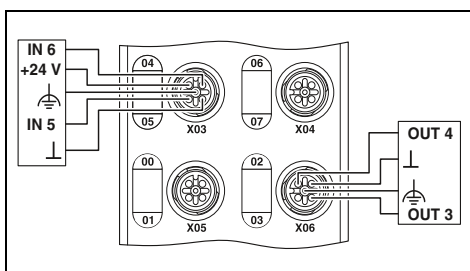

Ex:

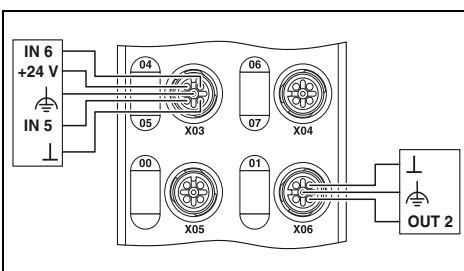

Ex:

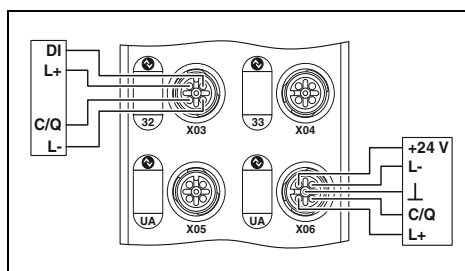

Technical data

AXL E EIP DI8 DO8 M12 6M AXL E EIP DI8 DO8 M12 6P

EtherNet/IP™
M12 connectors, D-coded
10/100 Mbps (with auto negotiation)

24 V DC
18 V DC ... 31.2 V DC (including all tolerances, including ripple)

M12 connector (T-coded)

M12 connector, double occupancy

2, 3, 4-wire

8 (EN 61131-2 types 1 and 3)

< 1000 µs

Overload protection, short-circuit protection of sensor supply

M12 connector, double occupancy

2, 3-wire

8

500 mA

Overload protection, short-circuit protection of outputs

-

-

-

-

-

750 g

198.5 mm

480 g

60 mm / 185 mm / 38 mm 60 mm / 185 mm / 30.5 mm

IP65/IP67

-25 °C ... 60 °C

Class A product, see page 527

Ordering data

Type	Order No.	Pcs. / Pkt.
AXL E EIP DI8 DO8 M12 6M	2701487	1
AXL E EIP DI8 DO8 M12 6P	2701492	1

Technical data

AXL E EIP DI8 DO4 2A M12 6M AXL E EIP DI8 DO4 2A M12 6P

EtherNet/IP™
M12 connectors, D-coded
10/100 Mbps (with auto negotiation)

24 V DC
18 V DC ... 31.2 V DC (including all tolerances, including ripple)

M12 connector (T-coded)

M12 connector, double occupancy

2, 3, 4-wire

8 (EN 61131-2 types 1 and 3)

< 1000 µs

Overload protection, short-circuit protection of sensor supply

M12 connector (A-coded)

2, 3-wire

4

2 A

Overload protection, short-circuit protection of outputs

-

-

-

-

-

750 g

198.5 mm

480 g

60 mm / 185 mm / 38 mm 60 mm / 185 mm / 30.5 mm

IP65/IP67

-25 °C ... 60 °C

Class A product, see page 527

Ordering data

Type	Order No.	Pcs. / Pkt.
AXL E EIP DI8 DO4 2A M12 6M	2701490	1
AXL E EIP DI8 DO4 2A M12 6P	2701495	1

Technical data

AXL E EIP IOL8 DI4 M12 6M AXL E EIP IOL8 DI4 M12 6P

EtherNet/IP™
M12 connectors, D-coded
10/100 Mbps (with auto negotiation)

24 V DC
18 V DC ... 31.2 V DC (including all tolerances, including ripple)

M12 connector (T-coded)

M12 connector, double occupancy

2, 3, 4-wire

4 (EN 61131-2 type 1)

< 1000 µs

Protection against polarity reversal

-

-

-

-

-

M12 connector

3, 5-wire

8

24 V DC

200 mA (during startup, up to 1.6 A for short periods)

Overload protection, electronics in the device

750 g

198.5 mm

480 g

60 mm / 185 mm / 38 mm 60 mm / 185 mm / 30.5 mm

IP65/IP67

-25 °C ... 60 °C

Class A product, see page 527

Ordering data

Type	Order No.	Pcs. / Pkt.
AXL E EIP IOL8 DI4 M12 6M	2701491	1
AXL E EIP IOL8 DI4 M12 6P	2701496	1

Modbus/TCP

Digital I/O devices – stand-alone

The I/O devices with a block design are used to acquire and output various signals.

Features:

- Robust metal or plastic housing
- Seamless connection via M12 connectors
- SPEEDCON fast locking system
- Maximum current carrying capacity of the supply 12 A
- Diagnostic and status indicators
- Short-circuit and overload protection

Additional features

IO-Link master:

- According to specification 1.1
- 4 digital inputs, 4 IO-Link ports Class A, 4 IO-Link ports Class B on one device



16 digital inputs



16 freely configurable inputs or outputs

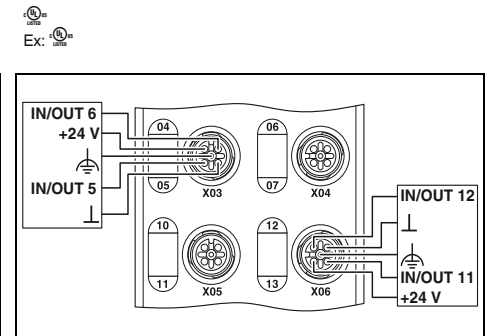
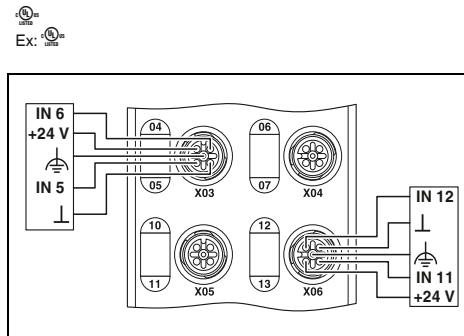

Technical data

AXL E ETH DI16 M12 6M AXL E ETH DI16 M12 6P

Ethernet
M12 connectors, D-coded
10/100 Mbps (with auto negotiation)

24 V DC
18 V DC ... 31.2 V DC (including all tolerances, including ripple)

M12 connector (T-coded)

M12 connector, double occupancy
2, 3, 4-wire
16 (EN 61131-2 types 1 and 3)
< 1000 µs

Overload protection, short-circuit protection of sensor supply

Technical data

AXL E ETH DIO16 M12 6M AXL E ETH DIO16 M12 6P

Ethernet
M12 connectors, D-coded
10/100 Mbps (with auto negotiation)

24 V DC
18 V DC ... 31.2 V DC (including all tolerances, including ripple)

M12 connector (T-coded)

M12 connector, double occupancy
2, 3, 4-wire
16 (EN 61131-2 types 1 and 3)
< 1000 µs

Overload protection, short-circuit protection of sensor supply

Interface	
Fieldbus system	Ethernet
Connection method	M12 connectors, D-coded
Transmission speed	10/100 Mbps (with auto negotiation)
Power supply for module electronics	24 V DC
Supply voltage	18 V DC ... 31.2 V DC (including all tolerances, including ripple)
Supply voltage range	
Connection method	M12 connector (T-coded)
Digital inputs	
Connection method	M12 connector, double occupancy
Connection technology	2, 3, 4-wire
Number of inputs	16 (EN 61131-2 types 1 and 3)
Input filter time	< 1000 µs
Protective circuit	Overload protection, short-circuit protection of sensor supply
Digital outputs	
Connection method	-
Connection technology	-
Number of outputs	-
Maximum output current per channel	-
Protective circuit	-
IO-Link ports	
Connection method	-
Connection technology	-
Number of ports	-
IO-Link port supply	-
I/O supply voltage	-
Nominal current for every IO-Link port	-
Protective circuit	-
General data	
Weight	750 g 480 g
Drill hole spacing	198.5 mm
Dimensions	W / H / D 60 mm / 185 mm / 38 mm 60 mm / 185 mm / 30.5 mm
Degree of protection	IP65/IP67
Ambient temperature (operation)	-25 °C ... 60 °C
EMC note	Class A product, see page 527

Ordering data

Description	Type	Order No.	Pcs. / Pkt.
Axioline I/O device			
- Robust metal housing	AXL E ETH DI16 M12 6M	2701538	1
- Plastic housing	AXL E ETH DI16 M12 6P	2701533	1

Ordering data

Description	Type	Order No.	Pcs. / Pkt.
Axioline I/O device			
- Robust metal housing	AXL E ETH DIO16 M12 6M	2701539	1
- Plastic housing	AXL E ETH DIO16 M12 6P	2701534	1



8 digital inputs and 8 digital outputs



8 digital inputs and 4 digital outputs



8 IO-Link ports, 4 digital inputs

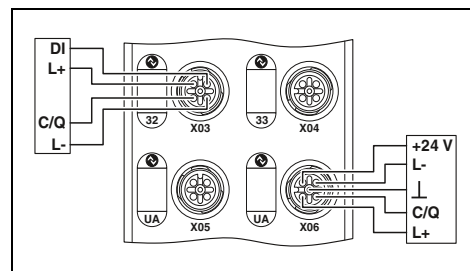
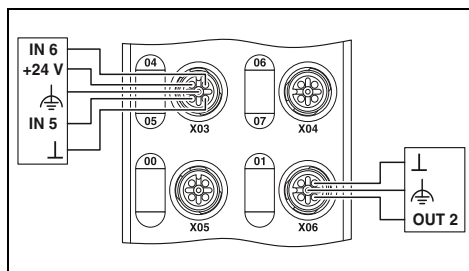
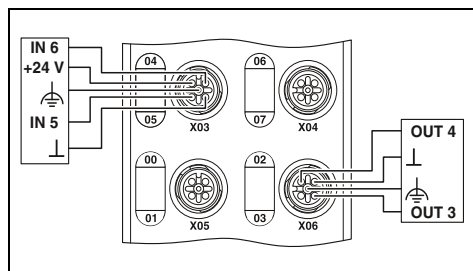

Technical data

Technical data

Technical data

AXL E ETH DI8 DO8 M12 6M AXL E ETH DI8 DO8 M12 6P

AXL E ETH DI8 DO4 2A M12 6M AXL E ETH DI8 DO4 2A M12 6P

AXL E ETH IOL8 DI4 M12 6M AXL E ETH IOL8 DI4 M12 6P

Ethernet
M12 connectors, D-coded
10/100 Mbps (with auto negotiation)

Ethernet
M12 connectors, D-coded
10/100 Mbps (with auto negotiation)

Ethernet
M12 connectors, D-coded
10/100 Mbps (with auto negotiation)

24 V DC
18 V DC ... 31.2 V DC (including all tolerances, including ripple)

24 V DC
18 V DC ... 31.2 V DC (including all tolerances, including ripple)

24 V DC
18 V DC ... 31.2 V DC (including all tolerances, including ripple)

M12 connector (T-coded)

M12 connector (T-coded)

M12 connector (T-coded)

M12 connector, double occupancy
2, 3, 4-wire
8 (EN 61131-2 types 1 and 3)
< 1000 µs

M12 connector, double occupancy
2, 3, 4-wire
8 (EN 61131-2 types 1 and 3)
< 1000 µs
Overload protection, short-circuit protection of sensor supply

M12 connector, double occupancy
2, 3, 4-wire
4 (EN 61131-2 type 1)
< 1000 µs
Protection against polarity reversal

M12 connector, double occupancy
2, 3-wire
8
500 mA
Overload protection, short-circuit protection of outputs

M12 connector (A-coded)
2, 3-wire
4
2 A
Overload protection, short-circuit protection of outputs

-
-
-
-

-
-
-
-
-

M12 connector
3, 5-wire
8

24 V DC
200 mA (during startup, up to 1.6 A for short periods)
Overload protection, electronics in the device

750 g 480 g
198.5 mm
60 mm / 185 mm / 38 mm 60 mm / 185 mm / 30.5 mm
IP65/IP67
-25 °C ... 60 °C
Class A product, see page 527

750 g 480 g
198.5 mm
60 mm / 185 mm / 38 mm 60 mm / 185 mm / 30.5 mm
IP65/IP67
-25 °C ... 60 °C
Class A product, see page 527

750 g 480 g
198.5 mm
60 mm / 185 mm / 38 mm 60 mm / 185 mm / 30.5 mm
IP65/IP67
-25 °C ... 60 °C
Class A product, see page 527

Ordering data

Ordering data

Ordering data

Type	Order No.	Pcs. / Pkt.
AXL E ETH DI8 DO8 M12 6M	2701537	1
AXL E ETH DI8 DO8 M12 6P	2701532	1

Type	Order No.	Pcs. / Pkt.
AXL E ETH DI8 DO4 2A M12 6M	2701540	1
AXL E ETH DI8 DO4 2A M12 6P	2701535	1

Type	Order No.	Pcs. / Pkt.
AXL E ETH IOL8 DI4 M12 6M	2701541	1
AXL E ETH IOL8 DI4 M12 6P	2701536	1

PROFINET

Digital I/O devices – stand-alone

The I/O devices with a block design are used to acquire and output various signals.

Features:

- Robust metal or plastic housing
- Seamless connection via M12 connectors
- SPEEDCON fast locking system
- Maximum current carrying capacity of the supply 12 A
- Diagnostic and status indicators
- Short-circuit and overload protection

Additional features

IO-Link master:

- According to specification 1.1
- 4 digital inputs, 4 IO-Link ports Class A, 4 IO-Link ports Class B on one device



16 digital inputs



16 freely configurable inputs or outputs

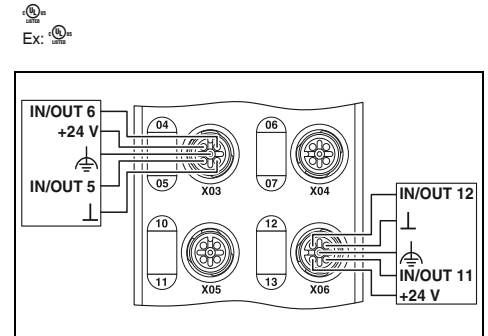
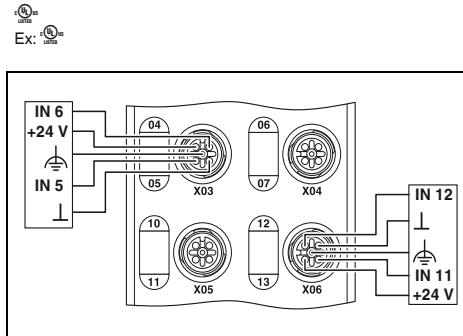

Technical data

AXL E PN DI16 M12 6M AXL E PN DI16 M12 6P

PROFINET

M12 connectors, D-coded
100 Mbps (with auto negotiation)

24 V DC

18 V DC ... 31.2 V DC (including all tolerances, including ripple)

M12 connector (T-coded)

M12 connector, double occupancy

2, 3, 4-wire

16 (EN 61131-2 types 1 and 3)

< 1000 µs

Overload protection, short-circuit protection of sensor supply

Technical data

AXL E PN DIO16 M12 6M AXL E PN DIO16 M12 6P

PROFINET

M12 connectors, D-coded
100 Mbps (with auto negotiation)

24 V DC

18 V DC ... 31.2 V DC (including all tolerances, including ripple)

M12 connector (T-coded)

M12 connector, double occupancy

2, 3, 4-wire

16 (EN 61131-2 types 1 and 3)

< 1000 µs

Overload protection, short-circuit protection of sensor supply

M12 connector, double occupancy

2, 3-wire

16

0.5 A

Overload protection, short-circuit protection of outputs

Interface	
Fieldbus system	PROFINET
Connection method	M12 connectors, D-coded
Transmission speed	100 Mbps (with auto negotiation)
Power supply for module electronics	
Supply voltage	24 V DC
Supply voltage range	18 V DC ... 31.2 V DC (including all tolerances, including ripple)
Connection method	M12 connector (T-coded)
Digital inputs	
Connection method	M12 connector, double occupancy
Connection technology	2, 3, 4-wire
Number of inputs	16 (EN 61131-2 types 1 and 3)
Input filter time	< 1000 µs
Protective circuit	Overload protection, short-circuit protection of sensor supply
Digital outputs	
Connection method	-
Connection technology	-
Number of outputs	-
Maximum output current per channel	-
Protective circuit	-
IO-Link ports	
Connection method	-
Connection technology	-
Number of ports	-
IO-Link port supply	
I/O supply voltage	-
Nominal current for every IO-Link port	-
Protective circuit	-
General data	
Weight	750 g 480 g
Drill hole spacing	198.5 mm
Dimensions	W / H / D 60 mm / 185 mm / 38 mm 60 mm / 185 mm / 30.5 mm
Degree of protection	IP65/IP67
Ambient temperature (operation)	-25 °C ... 60 °C
EMC note	Class A product, see page 527

Ordering data

Description	Type	Order No.	Pcs. / Pkt.
Axioline I/O device			
- Digital inputs	AXL E PN DI16 M12 6M	2701516	1
- Digital inputs	AXL E PN DI16 M12 6P	2701510	1

Ordering data

Description	Type	Order No.	Pcs. / Pkt.
Axioline I/O device			
- Freely configurable I/O	AXL E PN DIO16 M12 6M	2701517	1
- Freely configurable I/O	AXL E PN DIO16 M12 6P	2701511	1



8 digital inputs and 8 digital outputs



8 digital inputs and 4 digital outputs



8 IO-Link ports, 4 digital inputs

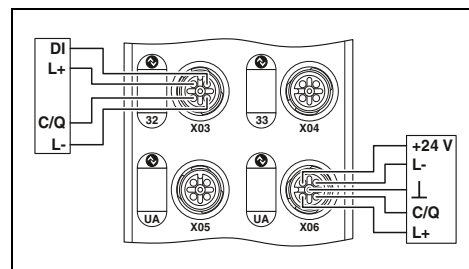
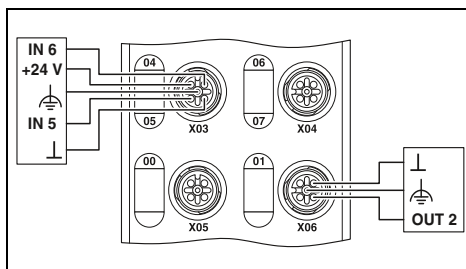
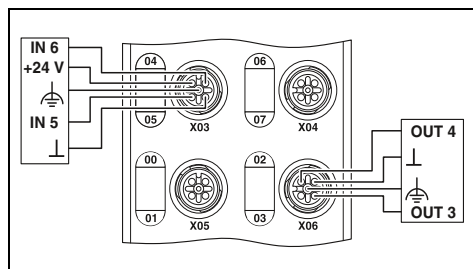

Technical data

Technical data

Technical data

AXL E PN DI8 DO8 M12 6M AXL E PN DI8 DO8 M12 6P

AXL E PN DI8 DO4 2A M12 6M AXL E PN DI8 DO4 2A M12 6P

AXL E PN IOL8 DI4 M12 6M AXL E PN IOL8 DI4 M12 6P

PROFINET
M12 connectors, D-coded
100 Mbps (with auto negotiation)

PROFINET
M12 connectors, D-coded
100 Mbps (with auto negotiation)

PROFINET
M12 connectors, D-coded
100 Mbps (with auto negotiation)

24 V DC

24 V DC

24 V DC

18 V DC ... 31.2 V DC (including all tolerances, including ripple)

18 V DC ... 31.2 V DC (including all tolerances, including ripple)

18 V DC ... 31.2 V DC (including all tolerances, including ripple)

M12 connector (T-coded)

M12 connector (T-coded)

M12 connector (T-coded)

M12 connector, double occupancy

M12 connector, double occupancy

M12 connector, double occupancy

2, 3, 4-wire

2, 3, 4-wire

2, 3, 4-wire

8 (EN 61131-2 types 1 and 3)

8 (EN 61131-2 types 1 and 3)

4 (EN 61131-2 type 1) 4 (EN 61131-2 types 1 and 3)

< 1000 µs

< 1000 µs

< 1000 µs

Overload protection, short-circuit protection of sensor supply

Overload protection, short-circuit protection of sensor supply

Protection against polarity reversal

M12 connector, double occupancy

M12 connector (A-coded)

-

2, 3-wire

2, 3-wire

-

8

4

-

500 mA

2 A

-

Overload protection, short-circuit protection of outputs

Overload protection, short-circuit protection of outputs

-

-

-

M12 connector

-

-

3, 5-wire

-

-

8

-

-

24 V DC

-

-

200 mA (during startup, up to 1.6 A for short periods)

-

-

Overload protection, electronics in the device

750 g

750 g

480 g

750 g

480 g

198.5 mm

198.5 mm

198.5 mm

60 mm / 185 mm / 38 mm 60 mm / 185 mm / 30.5 mm

60 mm / 185 mm / 38 mm 60 mm / 185 mm / 30.5 mm

60 mm / 185 mm / 38 mm 60 mm / 185 mm / 30.5 mm

IP65/IP67

IP65/IP67

IP65/IP67

-25 °C ... 60 °C

-25 °C ... 60 °C

-25 °C ... 60 °C

Class A product, see page 527

Class A product, see page 527

Class A product, see page 527

Ordering data

Ordering data

Ordering data

Type	Order No.	Pcs. / Pkt.
AXL E PN DI8 DO8 M12 6M	2701515	1
AXL E PN DI8 DO8 M12 6P	2701509	1

Type	Order No.	Pcs. / Pkt.
AXL E PN DI8 DO4 2A M12 6M	2701518	1
AXL E PN DI8 DO4 2A M12 6P	2701512	1

Type	Order No.	Pcs. / Pkt.
AXL E PN IOL8 DI4 M12 6M	2701519	1
AXL E PN IOL8 DI4 M12 6P	2701513	1

Sercos Digital I/O devices – stand-alone

The I/O devices with a block design are used to acquire and output various signals.

Features:

- Robust metal or plastic housing
- Seamless connection via M12 connectors
- SPEEDCON fast locking system
- Maximum current carrying capacity of the supply 12 A
- Diagnostic and status indicators
- Short-circuit and overload protection

Additional features

IO-Link master:

- According to specification 1.1
- 4 digital inputs, 4 IO-Link ports Class A, 4 IO-Link ports Class B on one device

SERCOS
the automation bus



16 digital inputs

SERCOS
the automation bus



16 freely configurable inputs or outputs

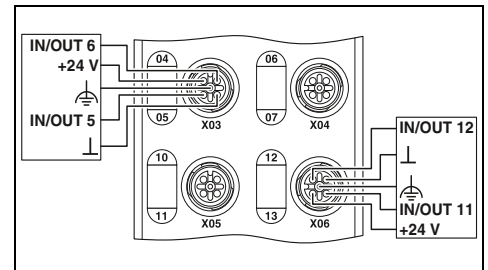
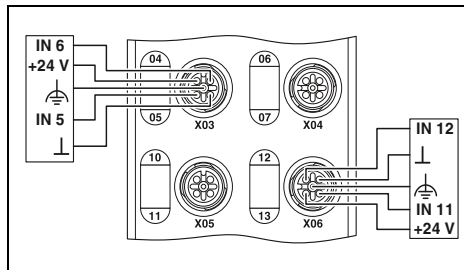

Technical data

AXL E S3 DI16 M12 6M AXL E S3 DI16 M12 6P

Sercos

M12 connectors, D-coded
100 Mbps (with auto negotiation)

24 V DC

18 V DC ... 31.2 V DC (including all tolerances, including ripple)

M12 connector (T-coded)

M12 connector, double occupancy

2, 3, 4-wire

16 (EN 61131-2 types 1 and 3)

< 1000 µs

Overload protection, short-circuit protection of sensor supply

Technical data

AXL E S3 DIO16 M12 6M AXL E S3 DIO16 M12 6P

Sercos

M12 connectors, D-coded
100 Mbps (with auto negotiation)

24 V DC

18 V DC ... 31.2 V DC (including all tolerances, including ripple)

M12 connector (T-coded)

M12 connector, double occupancy

2, 3, 4-wire

16 (EN 61131-2 types 1 and 3)

< 1000 µs

Overload protection, short-circuit protection of sensor supply

M12 connector, double occupancy

2, 3-wire

16

0.5 A

Overload protection, short-circuit protection of outputs

Interface	
Fieldbus system	Sercos
Connection method	M12 connectors, D-coded
Transmission speed	100 Mbps (with auto negotiation)
Power supply for module electronics	
Supply voltage	24 V DC
Supply voltage range	18 V DC ... 31.2 V DC (including all tolerances, including ripple)
Connection method	M12 connector (T-coded)
Digital inputs	
Connection method	M12 connector, double occupancy
Connection technology	2, 3, 4-wire
Number of inputs	16 (EN 61131-2 types 1 and 3)
Input filter time	< 1000 µs
Protective circuit	Overload protection, short-circuit protection of sensor supply
Digital outputs	
Connection method	-
Connection technology	-
Number of outputs	-
Maximum output current per channel	-
Protective circuit	-
IO-Link ports	
Connection method	-
Connection technology	-
Number of ports	-
IO-Link port supply	-
I/O supply voltage	-
Nominal current for every IO-Link port	-
Protective circuit	-
General data	
Weight	750 g 480 g
Drill hole spacing	198.5 mm
Dimensions	W / H / D 60 mm / 185 mm / 38 mm 60 mm / 185 mm / 30.5 mm
Degree of protection	IP65/IP67
Ambient temperature (operation)	-25 °C ... 60 °C
EMC note	Class A product, see page 527

Ordering data

Description	Type	Order No.	Pcs. / Pkt.
Axioline I/O device			
- Robust metal housing	AXL E S3 DI16 M12 6M	2701549	1
- Plastic housing	AXL E S3 DI16 M12 6P	2701544	1

Ordering data

Description	Type	Order No.	Pcs. / Pkt.
Axioline I/O device			
- Robust metal housing	AXL E S3 DIO16 M12 6M	2701550	1
- Plastic housing	AXL E S3 DIO16 M12 6P	2701545	1

SERCOS
the automation bus



8 digital inputs and 8 digital outputs

SERCOS
the automation bus



8 digital inputs and 4 digital outputs

SERCOS
the automation bus

IO-Link



8 IO-Link ports, 4 digital inputs

Ex:

Ex:

Ex:

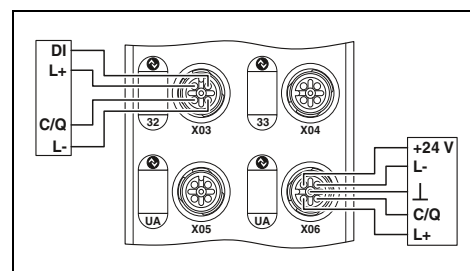
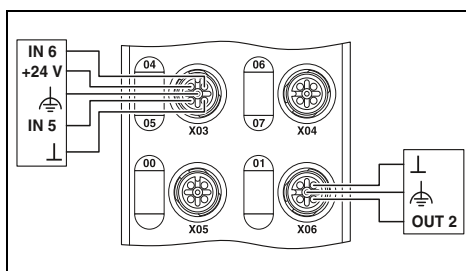
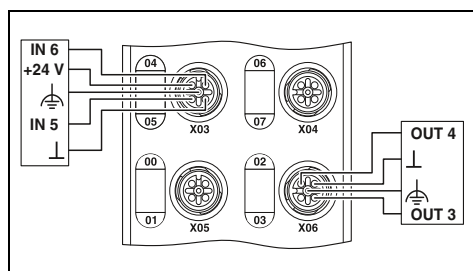

Technical data

Technical data

Technical data

AXL E S3 DI8 DO8 M12 6M AXL E S3 DI8 DO8 M12 6P

AXL E S3 DI8 DO4 2A M12 6M AXL E S3 DI8 DO4 2A M12 6P

AXL E S3 IOL8 DI4 M12 6M AXL E S3 IOL8 DI4 M12 6P

Sercos
M12 connectors, D-coded
100 Mbps (with auto negotiation)

Sercos
M12 connectors, D-coded
100 Mbps (with auto negotiation)

Sercos
M12 connectors, D-coded
100 Mbps (with auto negotiation)

24 V DC
18 V DC ... 31.2 V DC (including all tolerances, including ripple)

24 V DC
18 V DC ... 31.2 V DC (including all tolerances, including ripple)

24 V DC
18 V DC ... 31.2 V DC (including all tolerances, including ripple)

M12 connector (T-coded)

M12 connector (T-coded)

M12 connector (T-coded)

M12 connector, double occupancy

M12 connector, double occupancy

M12 connector, double occupancy

2, 3, 4-wire

2, 3, 4-wire

2, 3, 4-wire

8 (EN 61131-2 types 1 and 3)

8 (EN 61131-2 types 1 and 3)

4 (EN 61131-2 type 1)

< 1000 µs

< 1000 µs

< 1000 µs

Overload protection, short-circuit protection of sensor supply

Overload protection, short-circuit protection of sensor supply

Protection against polarity reversal

M12 connector, double occupancy

M12 connector (A-coded)

-

2, 3-wire

2, 3-wire

-

8

4

-

500 mA

2 A

-

Overload protection, short-circuit protection of outputs

Overload protection, short-circuit protection of outputs

-

-

-

M12 connector

-

-

3, 5-wire

-

-

8

-

-

24 V DC

-

-

200 mA (during startup, up to 1.6 A for short periods)

-

-

Overload protection, electronics in the device

750 g

750 g

480 g

750 g

480 g

198.5 mm

198.5 mm

198.5 mm

60 mm / 185 mm / 38 mm

60 mm / 185 mm / 38 mm

60 mm / 185 mm / 38 mm

60 mm / 185 mm / 30.5 mm

60 mm / 185 mm / 30.5 mm

60 mm / 185 mm / 30.5 mm

IP65/IP67

IP65/IP67

IP65/IP67

-25 °C ... 60 °C

-25 °C ... 60 °C

-25 °C ... 60 °C

Class A product, see page 527

Class A product, see page 527

Class A product, see page 527

Ordering data

Ordering data

Ordering data

Type	Order No.	Pcs. / Pkt.
AXL E S3 DI8 DO8 M12 6M	2701548	1
AXL E S3 DI8 DO8 M12 6P	2701542	1

Type	Order No.	Pcs. / Pkt.
AXL E S3 DI8 DO4 2A M12 6M	2701551	1
AXL E S3 DI8 DO4 2A M12 6P	2701546	1

Type	Order No.	Pcs. / Pkt.
AXL E S3 IOL8 DI4 M12 6M	2701552	1
AXL E S3 IOL8 DI4 M12 6P	2701547	1

PROFIBUS DP

Digital I/O devices – stand-alone

The I/O devices with a block design are used to acquire and output various signals.

Features:

- Robust metal or plastic housing
- Seamless connection via M12 connectors
- SPEEDCON fast locking system
- Maximum current carrying capacity of the supply 12 A
- Diagnostic and status indicators
- Short-circuit and overload protection

Additional features

IO-Link master:

- According to specification 1.1
- 4 digital inputs, 4 IO-Link ports Class A, 4 IO-Link ports Class B on one device



16 digital inputs



16 freely configurable inputs or outputs

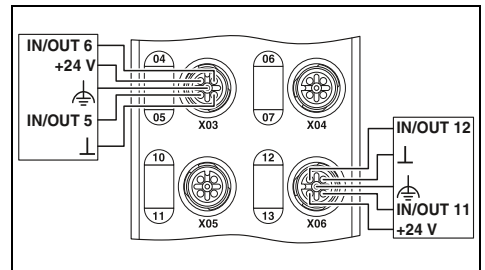
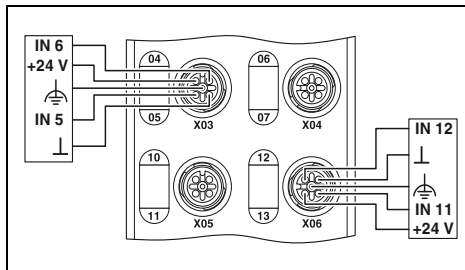

Technical data

AXL E PB DI16 M12 6M AXL E PB DI16 M12 6P

PROFIBUS DP

2x M12 connectors, B-coded
9.6 kbps ... 12 Mbps (automatic baud rate detection)

24 V DC

18 V DC ... 31.2 V DC (including all tolerances, including ripple)

M12 connector (T-coded)

M12 connector, double occupancy

2, 3, 4-wire

16 (EN 61131-2 types 1 and 3)

< 1000 µs

Overload protection, short-circuit protection of sensor supply

Technical data

AXL E PB DIO16 M12 6M AXL E PB DIO16 M12 6P

PROFIBUS DP

2x M12 connectors, B-coded
9.6 kbps ... 12 Mbps (automatic baud rate detection)

24 V DC

18 V DC ... 31.2 V DC (including all tolerances, including ripple)

M12 connector (T-coded)

M12 connector, double occupancy

2, 3, 4-wire

16 (EN 61131-2 types 1 and 3)

< 1000 µs

Overload protection, short-circuit protection of sensor supply

M12 connector, double occupancy

2, 3-wire

16

0.5 A

Overload protection, short-circuit protection of outputs

Interface	
Fieldbus system	
Connection method	
Transmission speed	
Power supply for module electronics	
Supply voltage	
Supply voltage range	
Connection method	
Digital inputs	
Connection method	
Connection technology	
Number of inputs	
Input filter time	
Protective circuit	
Digital outputs	
Connection method	
Connection technology	
Number of outputs	
Maximum output current per channel	
Protective circuit	
IO-Link ports	
Connection method	
Connection technology	
Number of ports	
IO-Link port supply	
I/O supply voltage	
Nominal current for every IO-Link port	
Protective circuit	
General data	
Weight	750 g 480 g
Drill hole spacing	198.5 mm
Dimensions	W / H / D 60 mm / 185 mm / 38 mm 60 mm / 185 mm / 30.5 mm
Degree of protection	IP65/IP67
Ambient temperature (operation)	-25 °C ... 60 °C
EMC note	Class A product, see page 527

Ordering data

Description	Type	Order No.	Pcs. / Pkt.
Axioline I/O device			
- Robust metal housing	AXL E PB DI16 M12 6M	2701505	1
- Plastic housing	AXL E PB DI16 M12 6P	2701498	1

Ordering data

Description	Type	Order No.	Pcs. / Pkt.
Axioline I/O device			
- Robust metal housing	AXL E PB DIO16 M12 6M	2701506	1
- Plastic housing	AXL E PB DIO16 M12 6P	2701499	1



8 digital inputs and 8 digital outputs



8 digital inputs and 4 digital outputs



8 IO-Link ports, 4 digital inputs

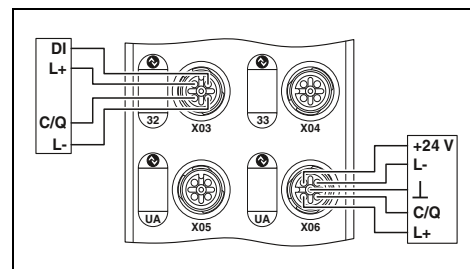
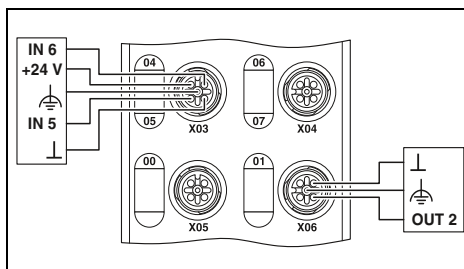
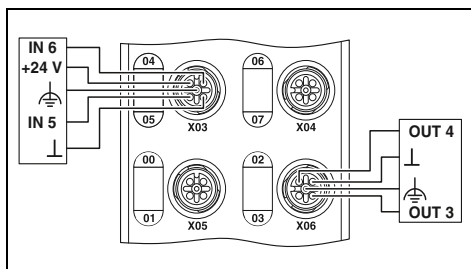

Technical data

AXL E PB DI8 DO8 M12 6M AXL E PB DI8 DO8 M12 6P

PROFIBUS DP
2x M12 connectors, B-coded
9.6 kbps ... 12 Mbps (automatic baud rate detection)

24 V DC
18 V DC ... 31.2 V DC (including all tolerances, including ripple)

M12 connector (T-coded)

M12 connector, double occupancy
2, 3, 4-wire
8 (EN 61131-2 types 1 and 3)

< 1000 µs
Overload protection, short-circuit protection of sensor supply

M12 connector, double occupancy
2, 3-wire
8
500 mA

Overload protection, short-circuit protection of outputs

-
-
-
-

750 g 480 g
198.5 mm
60 mm / 185 mm / 38 mm 60 mm / 185 mm / 30.5 mm
IP65/IP67
-25 °C ... 60 °C
Class A product, see page 527

Technical data

AXL E PB DI8 DO4 2A M12 6M AXL E PB DI8 DO4 2A M12 6P

PROFIBUS DP
2x M12 connectors, B-coded
9.6 kbps ... 12 Mbps (automatic baud rate detection)

24 V DC
18 V DC ... 31.2 V DC (including all tolerances, including ripple)

M12 connector (T-coded)

M12 connector, double occupancy
2, 3, 4-wire
8 (EN 61131-2 types 1 and 3)

< 1000 µs
Overload protection, short-circuit protection of sensor supply

M12 connector (A-coded)
2, 3-wire
4
2 A

Overload protection, short-circuit protection of outputs

-
-
-
-

750 g 480 g
198.5 mm
60 mm / 185 mm / 38 mm 60 mm / 185 mm / 30.5 mm
IP65/IP67
-25 °C ... 60 °C
Class A product, see page 527

Technical data

AXL E PB IOL8 DI4 M12 6M AXL E PB IOL8 DI4 M12 6P

PROFIBUS DP
2x M12 connectors, B-coded
9.6 kbps ... 12 Mbps (automatic baud rate detection)

24 V DC
18 V DC ... 31.2 V DC (including all tolerances, including ripple)

M12 connector (T-coded)

M12 connector, double occupancy
2, 3, 4-wire
4 (EN 61131-2 type 1) 4 (EN 61131-2 types 1 and 3)

< 1000 µs
Protection against polarity reversal

M12 connector
3, 5-wire
8

24 V DC
200 mA (during startup, up to 1.6 A for short periods)
Overload protection, electronics in the device

750 g 480 g
198.5 mm
60 mm / 185 mm / 38 mm 60 mm / 185 mm / 30.5 mm
IP65/IP67
-25 °C ... 60 °C
Class A product, see page 527

Ordering data

Type	Order No.	Pcs. / Pkt.
AXL E PB DI8 DO8 M12 6M	2701504	1
AXL E PB DI8 DO8 M12 6P	2701497	1

Ordering data

Type	Order No.	Pcs. / Pkt.
AXL E PB DI8 DO4 2A M12 6M	2701507	1
AXL E PB DI8 DO4 2A M12 6P	2701502	1

Ordering data

Type	Order No.	Pcs. / Pkt.
AXL E PB IOL8 DI4 M12 6M	2701508	1
AXL E PB IOL8 DI4 M12 6P	2701503	1

IO-Link/analog converters

IO-Link/analog converters are used to convert analog input or output signals to the IO-Link interface. You can connect the converters directly in the field.

Features:

- Large variety of analog functions
- Tailored combination of analog functions
- High transmission reliability
- Reduced cabling

IO-Link



1 analog input (0 ... 10 V)

IO-Link



1 analog input (4 ... 20 mA)

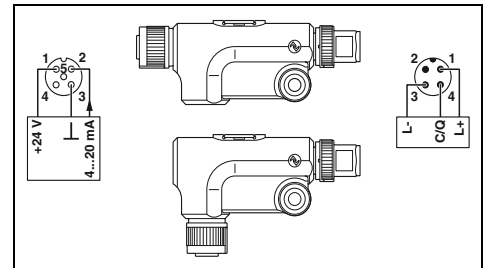
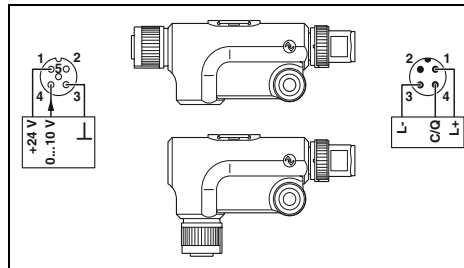

Technical data

AXL E IOL AI1 U M12 R AXL E IOL AI1 U M12 S

M12 connector, A-coded
3-wire
1

24 V DC (this supply voltage is provided via the IO-Link interface of the IO-Link master)

Max. 100 mA
Protection against polarity reversal
Short-circuit protection
Overload protection

M12 connector, A-coded
3-wire (optionally 4-wire)
1 (voltage)
0 V ... 10 V

-

-
-
-
-
-

-
-
-
-
-

34 g
16.6 mm / 42 mm / 66.5 mm 16.6 mm / 29 mm / 79.5 mm
IP65/IP67
-25 °C ... 60 °C
Class A product, see page 527

Ordering data

IO-Link ports
Connection method
Connection technology
Number of ports
IO-Link port supply
I/O supply voltage

Nominal current for every IO-Link port
Protective circuit

Analog inputs

Connection method
Connection technology
Number of inputs
Voltage input signal
Current input signal

Analog outputs

Connection method
Connection technology
Number of outputs
Voltage output signal
Current output signal

Temperature input

Connection method
Connection technology
Number of inputs
Sensor types (RTD) that can be used
Linear resistance measuring range

General data

Weight
Dimensions W / H / D
Degree of protection
Ambient temperature (operation)
EMC note

Technical data

AXL E IOL AI1 I M12 R AXL E IOL AI1 I M12 S

M12 connector, A-coded
3-wire
1

24 V DC (this supply voltage is provided via the IO-Link interface of the IO-Link master)

Max. 100 mA
Protection against polarity reversal
Short-circuit protection
Overload protection

M12 connector, A-coded
3-wire
1 (current)
4 mA ... 20 mA

-
-
-
-
-

-
-
-
-
-

34 g
16.6 mm / 42 mm / 66.5 mm 16.6 mm / 29 mm / 79.5 mm
IP65/IP67
-25 °C ... 60 °C
Class A product, see page 527

Ordering data

Description
IO-Link/analog converter
- Angled version
- Straight version

Type	Order No.	Pcs. / Pkt.
AXL E IOL AI1 U M12 R	2700273	1
AXL E IOL AI1 U M12 S	2700336	1

Type	Order No.	Pcs. / Pkt.
AXL E IOL AI1 I M12 R	2700275	1
AXL E IOL AI1 I M12 S	2700338	1



1 analog output (0 ... 10 V)



1 analog output (4 ... 20 mA)



1 RTD input

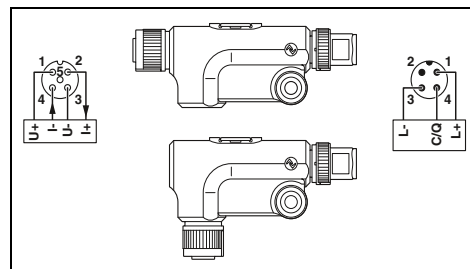
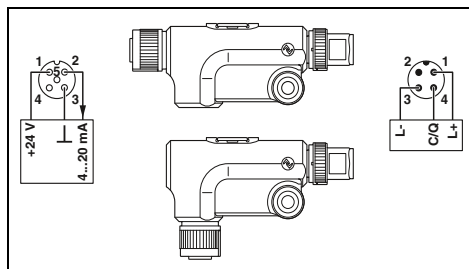
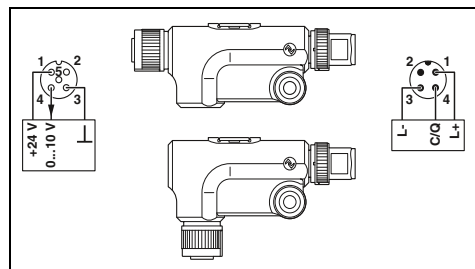

Technical data

AXL E IOL AO1 U M12 R AXL E IOL AO1 U M12 S

M12 connector, A-coded
3-wire
1

24 V DC (this supply voltage is provided via the IO-Link interface of the IO-Link master)

Max. 100 mA
Protection against polarity reversal
Short-circuit protection
Overload protection

M12 connector, A-coded
3-wire
1 (voltage)
0 V ... 10 V

34 g
16.6 mm / 42 mm / 66.5 mm 16.6 mm / 29 mm / 79.5 mm
IP65/IP67
-25 °C ... 60 °C
Class A product, see page 527

Ordering data

Type	Order No.	Pcs. / Pkt.
AXL E IOL AO1 U M12 R	2700278	1
AXL E IOL AO1 U M12 S	2700350	1

Technical data

AXL E IOL AO1 I M12 R AXL E IOL AO1 I M12 S

M12 connector, A-coded
3-wire
1

24 V DC (this supply voltage is provided via the IO-Link interface of the IO-Link master)

Max. 100 mA
Protection against polarity reversal
Short-circuit protection
Overload protection

M12 connector, A-coded
3-wire
1 (current)
4 mA ... 20 mA

34 g
16.6 mm / 42 mm / 66.5 mm 16.6 mm / 29 mm / 79.5 mm
IP65/IP67
-25 °C ... 60 °C
Class A product, see page 527

Ordering data

Type	Order No.	Pcs. / Pkt.
AXL E IOL AO1 I M12 R	2700282	1
AXL E IOL AO1 I M12 S	2700351	1

Technical data

AXL E IOL RTD1 M12 R AXL E IOL RTD1 M12 S

M12 connector, A-coded
3-wire
1

24 V DC (this supply voltage is provided via the IO-Link interface of the IO-Link master)

Max. 100 mA
Protection against polarity reversal
Short-circuit protection
Overload protection

M12 connector, A-coded
3-wire (optionally 4-wire)
1 (for resistance temperature detectors)
Pt 100, Pt 1000
0 Ω ... 500 Ω (IB IL format) / 0 Ω ... 5 kΩ (IB IL format) / 0 Ω ... 600 Ω (format: S7-compatible) / 0 Ω ... 6 kΩ (format: S7-compatible)

34 g
16.6 mm / 42 mm / 66.5 mm 16.6 mm / 29 mm / 79.5 mm
IP65/IP67
-25 °C ... 60 °C
Class A product, see page 527

Ordering data

Type	Order No.	Pcs. / Pkt.
AXL E IOL RTD1 M12 R	2700305	1
AXL E IOL RTD1 M12 S	2700352	1

I/O systems

For field installation (IP67) – Fieldline Modular

Product overview

Bus couplers – modular



					
242	243	243	244	245	245

M12 I/O devices – modular



Digital input		Digital input/output		Digital output	
8 channels	16 channels	4/4 channels	8/8 channels	16/16 channels	8 channels
246	246	247	247	247	247
IO-Link master		Analog input		Analog output	
4 IO-Link ports	4 channels	4 channels	4 channels	4 channels (RTD)	
248	249	249	249	249	

M8 I/O devices – modular



Digital input	Digital input/output	Digital output	
8 channels	8 channels	4 channels	8 channels
250	251	251	251

Accessories



FLM ADAP M12/M8
Fieldline Modular
M12/M8 adapters

252



IB IL 24 FLM ...-PAC
Inline Modular branch terminal

252



SAC...2XM12...
M12 bus system T-connector

253



SAC-5P-M12MS ... TR
M12 termination resistor,
PROFIBUS and
DeviceNet™/CANopen®

253



SAC-3P-M12Y/2XM12FS PE
M12 Y-distributor/connector

253



FLM MP...
Mounting plates

252



PROT-M12/M8 ...
Sealing caps

253



ZBF 12 .../ZBF 8 ...
Marking material

253



...
Bus and power cables with M12
connector

254



SAC-4P-M ...
Bus and power cables with M8
connector

256



SACC-M12.../SACC-M8...
M12/M8 connectors that can be
assembled

257



PROJECT+
Software for planning the
I/O configuration

454

General technical data**Ambient conditions**

Temperature range (operation)	-25°C ... +60°C
Permissible humidity (storage/transport)	95%
Vibration	5g according to EN 60068-2-6
Shock	30g according to EN 60068-2-27
Degree of protection	IP65/IP67 according to IEC 60529

Electromagnetic compatibility

Noise emission	Class A according to DIN EN 55022
----------------	-----------------------------------

Supply voltage

Nominal value	24 V DC
Permissible range	19.2 V DC ... 30.0 V DC, including ripple

Bus couplers – Modular

The bus couplers open a high-performance local bus with up to 16 devices.

The following protocols are supported:

- INTERBUS
- PROFINET
- PROFIBUS
- DeviceNet™
- EtherNet/IP™
- Modbus/TCP

Notes:

A comprehensive range of installation materials for field installation can be found on page 252

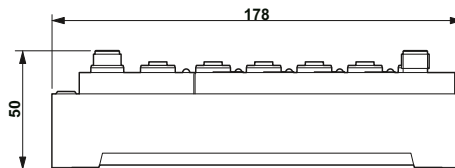

INTERBUS

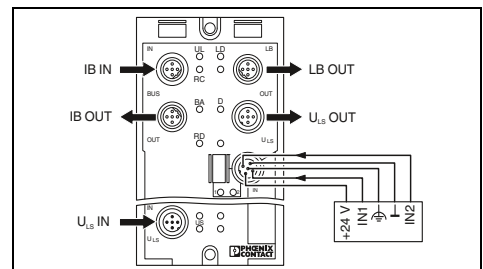

Technical data

Interface	Fieldbus system Connection method Number of positions Transmission speed	INTERBUS M12 connector, B-coded 5 500 kBaud/2 Mbaud, can be selected
Power supply for module electronics	Supply voltage Connection method Supply voltage range	24 V DC M12 connector 18 V DC ... 30 V DC (including ripple)
Local bus gateway	Transmission speed Connection method Max. number of local bus devices Max. length of local bus	500 kBaud/2 Mbaud, can be selected M12 connector, B-coded 16 20 m
Digital inputs	Connection method Connection technology Number of inputs Filter time Input characteristic curve Protective circuit	M12 connector 2, 3, 4-wire 8 (double occupancy) 3 ms IEC 61131-2 type 1 Protection against polarity reversal
General data	Weight Drill hole spacing Width Degree of protection Ambient temperature (operation) EMC note	280 g 168 mm 70 mm IP65/IP67 -25 °C ... 60 °C Class A product, see page 527

Ordering data

Description	Type	Order No.	Pcs. / Pkt.
Fieldline Modular M12 bus coupler - INTERBUS M12 - PROFINET M12 - PROFIBUS M12	FLM BK IB M12 DI 8 M12	2736301	1



PROFINET



PROFIBUS

PROFIBUS

PROFIBUS
Ex: PROFIBUS

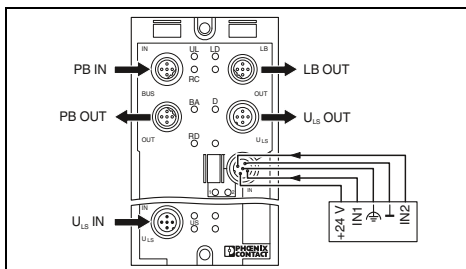
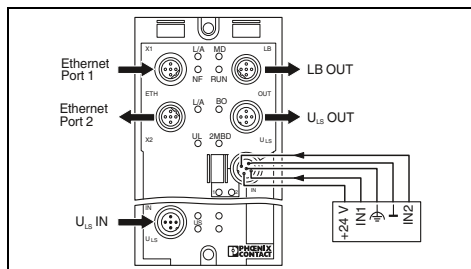

Technical data

Technical data

PROFINET
M12 connectors, D-coded
4
100 Mbps, auto negotiation

PROFIBUS DP
M12 connector, B-coded
5
9.64 kBaud to 12 Mbaud automatic detection

24 V DC
M12 connector
18 V DC ... 30 V DC (including ripple)

24 V DC
M12 connector
18 V DC ... 30 V DC (including ripple)

500 kBaud/2 Mbaud, can be selected
M12 connector, B-coded
16
20 m

500 kBaud/2 Mbaud, can be selected
M12 connector, B-coded
16
20 m

M12 connector
2, 3, 4-wire
8 (EN 61131-2 type 1)
3 ms
IEC 61131-2 type 1
Protection against polarity reversal

M12 connector
2, 3, 4-wire
8 (double occupancy)
3 ms
IEC 61131-2 type 1
Protection against polarity reversal

280 g
168 mm
70 mm
IP65/IP67
-25 °C ... 55 °C
Class A product, see page 527

280 g
168 mm
70 mm
IP65/IP67
-25 °C ... 60 °C
Class A product, see page 527

Ordering data

Ordering data

Type	Order No.	Pcs. / Pkt.
FLM BK PN M12 DI 8 M12-2TX	2736741	1

Type	Order No.	Pcs. / Pkt.
FLM BK PB M12 DI 8 M12-EF	2773377	1

Bus couplers – Modular

The bus couplers open a high-performance local bus with up to 16 devices.

The following protocols are supported:

- INTERBUS
- PROFINET
- PROFIBUS
- DeviceNet™
- EtherNet/IP™
- Modbus/TCP

Notes:

A comprehensive range of installation materials for field installation can be found on page 252

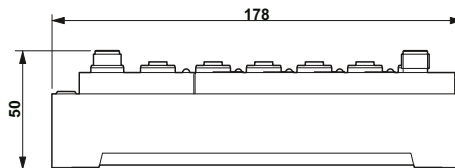

DeviceNet



DeviceNet™



EX: 0 94 US

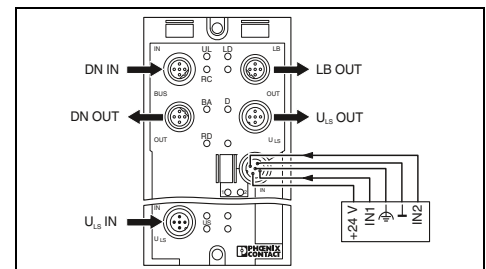

Technical data

Interface	
Fieldbus system	DeviceNet™
Connection method	M12 connector, A-coded
Number of positions	5
Transmission speed	125 kBaud, 250 kBaud, 500 kBaud automatic detection
Address area assignment	0 ... 63, can be set
Power supply for module electronics	
Supply voltage	24 V DC
Connection method	M12 connector
Supply voltage range	18 V DC ... 30 V DC (including ripple)
Local bus gateway	
Transmission speed	500 kBaud/2 Mbaud, can be selected
Connection method	M12 connector, B-coded
Max. number of local bus devices	16
Max. length of local bus	20 m
Digital inputs	
Connection method	M12 connector
Connection technology	2, 3, 4-wire
Number of inputs	8 (double occupancy)
Filter time	3 ms
Input characteristic curve	IEC 61131-2 type 1
Protective circuit	Protection against polarity reversal
General data	
Weight	280 g
Drill hole spacing	178 mm
Width	70 mm
Degree of protection	IP65/IP67
Ambient temperature (operation)	-25 °C ... 60 °C
EMC note	Class A product, see page 527

Ordering data

Description	Type	Order No.	Pcs. / Pkt.
Fieldline Modular M12 bus coupler - DeviceNet™ M12 - EtherNet/IP™ M12 - Ethernet M12	FLM BK DN M12 DI 8 M12	2736343	1

EtherNet/IP



EtherNet/IP™

Ethernet



Modbus/TCP

Ex:

Ex:

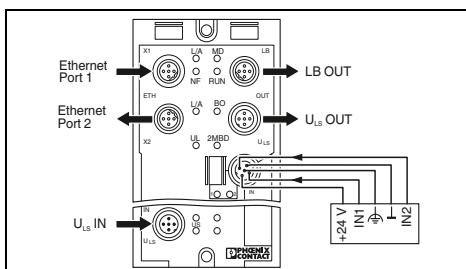
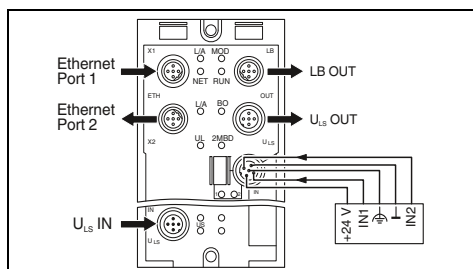

Technical data

Technical data

EtherNet/IP™
M12 connectors, D-coded
4
10/100 Mbps, auto negotiation

Ethernet
M12 connectors, D-coded
4
10/100 Mbps, auto negotiation

24 V DC
M12 connector
18 V DC ... 30 V DC (including ripple)

24 V DC
M12 connector
18 V DC ... 30 V DC (including ripple)

500 kBaud/2 Mbaud, can be selected
M12 connector, B-coded
16
20 m

500 kBaud/2 Mbaud, can be selected
M12 connector, B-coded
16
20 m

M12 connector
2, 3, 4-wire
8 (EN 61131-2 type 1)
3 ms
IEC 61131-2 type 1
Protection against polarity reversal

M12 connector
2, 3, 4-wire
8 (EN 61131-2 type 1)
3 ms
IEC 61131-2 type 1
Protection against polarity reversal

280 g
178 mm
70 mm
IP65/IP67
-25 °C ... 60 °C

280 g
178 mm
70 mm
IP65/IP67
-25 °C ... 60 °C

Ordering data

Ordering data

Type	Order No.	Pcs. / Pkt.
FLM BK EIP M12 DI 8 M12-2TX	2773322	1

Type	Order No.	Pcs. / Pkt.
FLM BK ETH M12 DI 8 M12-2TX	2736916	1

M12 digital I/O devices – Modular

The local bus devices are used to acquire and output digital signals in a Fieldline Modular station.

Features:

- Seamless connection via M12 connectors
- SPEEDCON fast locking system
- Flexible power supply concept
- Diagnostic and status indicators
- Short-circuit and overload protection

Notes:

A comprehensive range of installation materials for field installation can be found on page 252

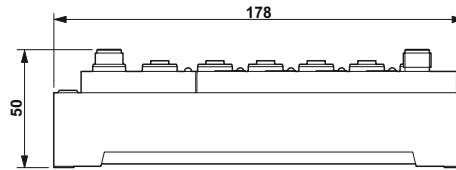

8/16 digital inputs

UL US
EX: UL US

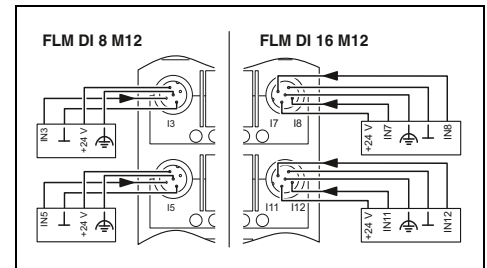

Technical data

	FLM DI 8 M12		FLM DI 16 M12	
	Interface			
Designation	Fieldline local bus			
Connection method	M12 connector, B-coded			
Transmission speed	500 kbps / 2 Mbps			
Power supply for module electronics				
Supply voltage	24 V DC			
Connection method	M12 connector			
Supply voltage range	18 V DC ... 30 V DC (including ripple)			
Digital inputs				
Connection method	M12 connector			
Connection technology	2, 3, 4-wire			
Number of inputs	8		16	
Filter time	3 ms			
Input characteristic curve	IEC 61131-2 type 1			
Protective circuit	Protection against polarity reversal			
Digital outputs				
Connection method	-			
Connection technology	-			
Number of outputs	-			
Maximum output current per channel	-			
Protective circuit	-			
General data				
Weight	290 g		310 g	
Drill hole spacing	168 mm			
Width	70 mm			
Degree of protection	IP65/IP67			
Ambient temperature (operation)	-25 °C ... 60 °C			
EMC note	Class A product, see page 527			

Ordering data

Description	Type	Order No.	Pcs. / Pkt.
Fieldline Modular M12 digital input device			
- 8 inputs	FLM DI 8 M12	2736288	1
- 16 inputs	FLM DI 16 M12	2736835	1
Fieldline Modular M12 digital I/O device			
- 4 inputs, 4 outputs, 2 A			
- 8 inputs, 8 outputs			
- 16 inputs, 16 outputs			
Fieldline Modular M12 digital output device			
- 8 outputs			



4/8 digital inputs and
4/8 digital outputs



16 digital inputs,
16 digital outputs,
and extended diagnostics



8 digital outputs

ERIC
Ex: ERIC

ERIC
Ex: ERIC

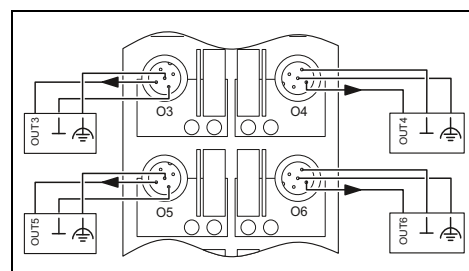
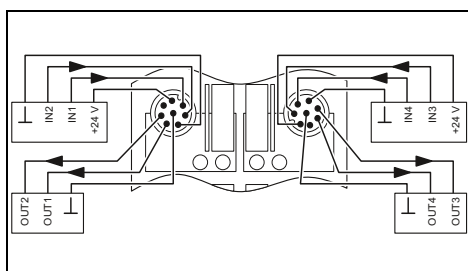
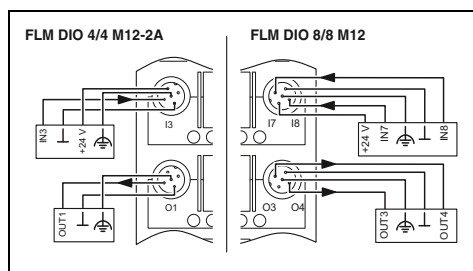

Technical data		
FLM DIO 4/4 M12-2A	FLM DIO 8/8 M12	
Fieldline local bus M12 connector, B-coded 500 kbps / 2 Mbps		
24 V DC M12 connector 18 V DC ... 30 V DC (including ripple)		
M12 connector 2, 3, 4-wire	4	8
3 ms IEC 61131-2 type 1 Protection against polarity reversal		
M12 connector 2, 3-wire	4	8
2 A	500 mA	500 mA
Short-circuit protection		
315 g	330 g	
168 mm 70 mm IP65/IP67 -25 °C ... 60 °C Class A product, see page 527		

Technical data		
Fieldline local bus M12 connector, B-coded 500 kbps / 2 Mbps		
24 V DC M12 connector 18 V DC ... 30 V DC (including ripple)		
M12 connector, 8-pos. 2, 3-wire	16	16
3 ms IEC 61131-2 type 1 Protection against polarity reversal		
M12 connector, 8-pos. 2-wire	16	500 mA
Short-circuit protection, overload protection of the sensor supply		
400 g		
168 mm 70 mm IP65/IP67 -25 °C ... 60 °C Class A product, see page 527		

Technical data		
Fieldline local bus M12 connector, B-coded 500 kbps / 2 Mbps		
24 V DC M12 connector 18 V DC ... 30 V DC (including ripple)		
-	-	-
M12 connector 2, 3-wire		
8	500 mA	500 mA
Short-circuit protection		
310 g		
168 mm 70 mm IP65/IP67 -25 °C ... 60 °C Class A product, see page 527		

Ordering data		
Type	Order No.	Pcs. / Pkt.
FLM DIO 4/4 M12-2A	2736369	1
FLM DIO 8/8 M12	2736848	1

Ordering data		
Type	Order No.	Pcs. / Pkt.
FLM DIO 16/16 M12/8-DIAG	2736738	1

Ordering data		
Type	Order No.	Pcs. / Pkt.
FLM DO 8 M12	2736291	1

M12 IO-Link master – Modular

The IO-Link master enables the easy integration of IO-Link devices into a Fieldline Modular station.

Features:

- 4 IO-Link ports and 4 digital inputs
- Seamless connection via M12 connectors
- SPEEDCON fast locking system
- Flexible power supply concept
- Diagnostic and status indicators
- Short-circuit and overload protection

Notes:

A comprehensive range of installation materials for field installation can be found on page 252

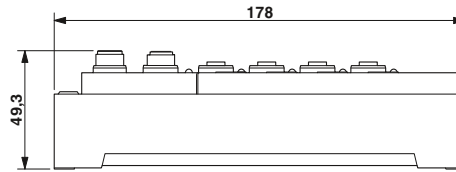

IO-Link



4 IO-Link ports and 4 digital inputs

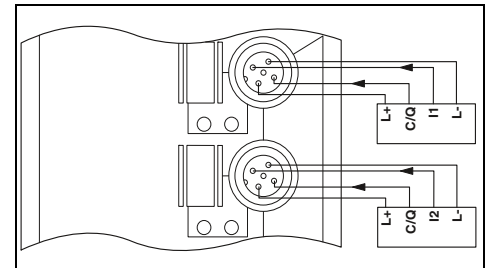

Technical data

Interface	
Designation	Fieldline local bus
Connection method	M12 connector, B-coded
Transmission speed	500 kbps / 2 Mbps
Power supply for module electronics	
Supply voltage	24 V DC
Connection method	M12 connector
Supply voltage range	18 V DC ... 30 V DC (including ripple)
IO-Link ports	
Connection method	M12 connector
Connection technology	3-wire
Number of ports	4
IO-Link port supply	
I/O supply voltage	min. $U_S - 1$ V
Nominal current for every IO-Link port	Max. 200 mA
Nominal current per device	800 mA
Protective circuit	Overload protection, electronics in the device Short-circuit protection, electronics in the device
Digital inputs	
Connection method	M12 connector
Connection technology	2, 3-wire
Number of inputs	4
Input filter time	typ. 3 ms
Input characteristic curve	IEC 61131-2 type 1
Protective circuit	Protection against polarity reversal
General data	
Weight	280 g
Drill hole spacing	168 mm
Width	70 mm
Degree of protection	IP65/IP67
Ambient temperature (operation)	-25 °C ... 60 °C

Ordering data

Description	Type	Order No.	Pcs. / Pkt.
Fieldline Modular M12 I/O device - IO-Link master with four IO-Link ports and four digital inputs	FLM IOL4 DI4 M12	2736990	1

M12 analog I/O devices – Modular

The local bus devices are used to acquire and output analog signals in a Fieldline Modular station.

Features:

- Seamless connection via M12 connectors
- SPEEDCON fast locking system
- Flexible power supply concept
- Diagnostic and status indicators
- Short-circuit and overload protection

Notes:
A comprehensive range of installation materials for field installation can be found on page 252



4 analog inputs/outputs



4 temperature inputs for resistive sensors

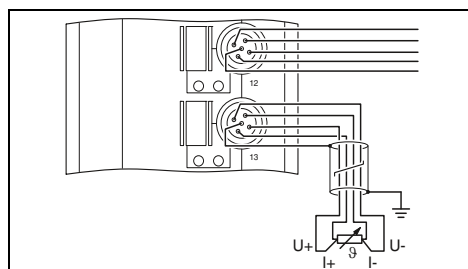
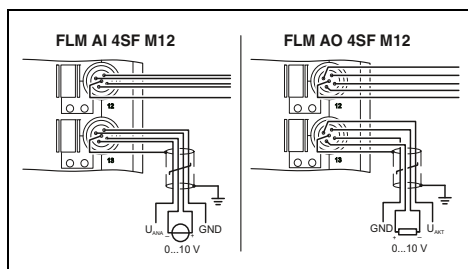

Interface	
Designation	Fieldline local bus
Connection method	M12 connector, B-coded
Transmission speed	500 kbps / 2 Mbps
Power supply for module electronics	
Supply voltage	24 V DC
Supply voltage range	18 V DC ... 30 V DC (including ripple)
Analog inputs	
Connection technology	2, 4-wire
Number of inputs	Max. 4 (differential inputs, voltage or current)
Voltage input signal	0 V ... 5 V / -5 V ... 5 V / 0 V ... 10 V / -10 V ... 10 V
Current input signal	0 mA ... 20 mA / 4 mA ... 20 mA / -20 mA ... 20 mA
Protective circuit for voltage input	Protection against polarity reversal
Process data update	-
Analog outputs	
Connection technology	2, 4-wire
Number of outputs	4
Voltage output signal	0 V ... 5 V / -5 V ... 5 V / 0 V ... 10 V / -10 V ... 10 V
Current output signal	0 mA ... 20 mA / 4 mA ... 20 mA
Protective circuit	Short-circuit protection
General data	
Connection method	M12 connector
Weight	280 g
Drill hole spacing	168 mm
Width	70 mm
Degree of protection	IP65/IP67
Ambient temperature (operation)	-25 °C ... 60 °C
EMC note	Class A product, see page 527

Technical data	
FLM AI 4 SF M12	FLM AO 4 SF M12
Fieldline local bus	
M12 connector, B-coded	
500 kbps / 2 Mbps	
24 V DC	
18 V DC ... 30 V DC (including ripple)	
2, 4-wire	-
Max. 4 (differential inputs, voltage or current)	-
0 V ... 5 V / -5 V ... 5 V / 0 V ... 10 V / -10 V ... 10 V	-
0 mA ... 20 mA / 4 mA ... 20 mA / -20 mA ... 20 mA	-
Protection against polarity reversal	-
-	-
-	2, 4-wire
-	4
-	0 V ... 5 V / -5 V ... 5 V / 0 V ... 10 V / -10 V ... 10 V
-	0 mA ... 20 mA / 4 mA ... 20 mA
-	Short-circuit protection
M12 connector	
280 g	
168 mm	
70 mm	
IP65/IP67	
-25 °C ... 60 °C	
Class A product, see page 527	

Technical data	
Fieldline local bus	
M12 connector, B-coded	
500 kbps / 2 Mbps	
24 V DC	
18 V DC ... 30 V DC (including ripple)	
2, 3, 4-wire (shielded)	
Max. 4 (for resistance temperature detectors)	
-	
-	
Dependent on the connection technology	
M12 connector	
280 g	
168 mm	
70 mm	
IP65/IP67	
-25 °C ... 60 °C	
Class A product, see page 527	

Ordering data	
Description	Type
Fieldline Modular M12 analog input device	
- 4 inputs	FLM AI 4 SF M12
Fieldline Modular M12 analog output device	
- 4 outputs	FLM AO 4 SF M12

Ordering data		
Type	Order No.	Pcs. / Pkt.
FLM AI 4 SF M12	2736453	1
FLM AO 4 SF M12	2736466	1

Ordering data		
Type	Order No.	Pcs. / Pkt.
FLM TEMP 4 RTD M12	2736819	1

M8 digital I/O devices – Modular

The narrow local bus devices are particularly suitable for use on machines close to the process.

Features:

- Seamless connection via M8 connectors
- Optimized for 30 mm mounting profile
- Can also be connected to an Inline station
- Diagnostic and status indicators
- Short-circuit and overload protection

Notes:

A comprehensive range of installation materials for field installation can be found on page 252

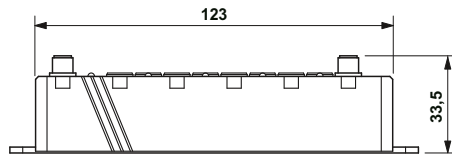

8 digital inputs

UL US
Ex: cUL US

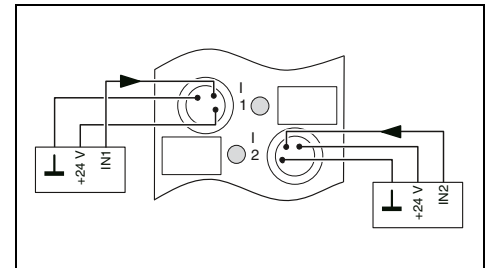

Technical data

Interface	
Designation	Fieldline local bus
Connection method	M8 connector
Power supply for module electronics	
Supply voltage	24 V DC
Connection method	M8 connector
Supply voltage range	18 V DC ... 30 V DC (including ripple)
Digital inputs	
Connection method	M8 connector
Connection technology	2, 3-wire
Number of inputs	8
Filter time	3 ms
Input characteristic curve	IEC 61131-2 type 1
Protective circuit	Protection against polarity reversal
Digital outputs	
Connection method	-
Connection technology	-
Number of outputs	-
Maximum output current per channel	-
Protective circuit	-
General data	
Weight	137 g
Drill hole spacing	133 mm
Width	29.8 mm
Degree of protection	IP65/IP67
Ambient temperature (operation)	-25 °C ... 60 °C
EMC note	

Ordering data

Description	Type	Order No.	Pcs. / Pkt.
Fieldline Modular M8 digital input device			
- 8 inputs, 500 kBD			
Fieldline Modular M8 digital I/O device			
- 4 inputs fixed, 4 inputs/outputs freely selectable, 500 kBD	FLM DI 8 M8	2773348	1
Fieldline Modular M8 digital output device			
- 4 outputs, 2 A, 500 kBD			
- 8 outputs, 500 kBD			



4 digital inputs and 4 digital inputs or outputs



4 digital outputs



8 digital outputs

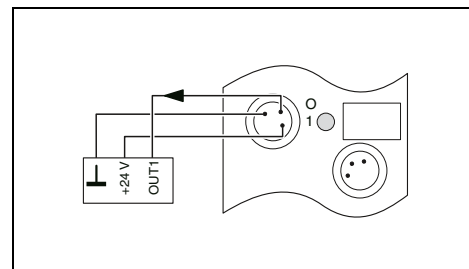
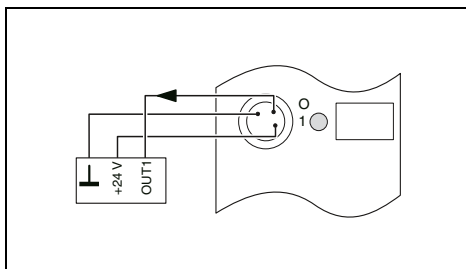
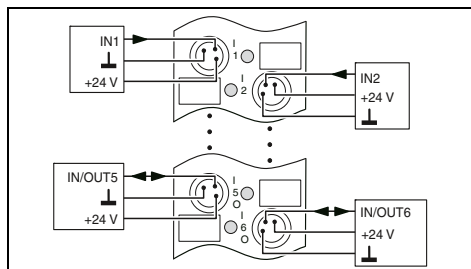

Technical data
Fieldline local bus M8 connector
24 V DC M8 connector 18 V DC ... 30 V DC (including ripple)
M8 connector 2, 3-wire 8 (4 fixed, 4 freely selectable) 3 ms IEC 61131-2 type 1 Protection against polarity reversal
M8 connector 2, 3-wire 4 (can also be used as an input) 500 mA Short-circuit protection
144 g 133 mm 29.8 mm IP65/IP67 -25 °C ... 60 °C Class A product, see page 527

Technical data
Fieldline local bus 2 M8 connectors
24 V DC M8 connector 18 V DC ... 30 V DC (including ripple)
M8 connector 2, 3-wire 4 2 A Short-circuit protection
137 g 133 mm 29.8 mm IP65/IP67 -25 °C ... 60 °C Class A product, see page 527

Technical data
Fieldline local bus M8 connector
24 V DC M8 connector 18 V DC ... 30 V DC (including ripple)
M8 connector 2, 3-wire 8 500 mA Short-circuit protection
137 g 133 mm 29.8 mm IP65/IP67 -25 °C ... 60 °C Class A product, see page 527

Ordering data		
Type	Order No.	Pcs. / Pkt.
FLM DIO 8/4 M8	2773351	1

Ordering data		
Type	Order No.	Pcs. / Pkt.
FLM DO 4 M8-2A	2736932	1

Ordering data		
Type	Order No.	Pcs. / Pkt.
FLM DO 8 M8	2736893	1

Coupling options

Various adapters are available for connecting two systems.

- Connection of Fieldline Modular M8 to Fieldline Modular M12
- Connection of Fieldline Modular M8 or M12 to Inline Modular



Fieldline Modular M12/M8/Inline adapter

Local bus interface
Interface
Connection method
Local bus interface
Interface
Connection method

Technical data

Fieldline Modular M12 local bus
M12 connector, B-coded

Fieldline Modular M8 local bus
2 M8 connectors

Description
Adapter piece for coupling Fieldline Modular M8 local bus devices to a Fieldline Modular M12 local bus
Inline Modular branch terminal for coupling one Fieldline Modular M8 local bus at the end of an Inline station
Inline Modular branch terminal for coupling one Fieldline Modular M8 local bus to any location on each Inline station

Ordering data

Type	Order No.	Pcs. / Pkt.
FLM ADAP M12/M8	2736961	1
IB IL 24 FLM-PAC	2736903	1
IB IL 24 FLM MULTI-PAC	2737009	1

Mounting plates

Up to seven Fieldline Modular M12 devices can be mounted on the mounting plates.



Mounting plate for up to 5 or 7 Fieldline Modular devices

General data
Width
Depth
Height
Hole diameter
Note on dimensions
Assembly instructions
Material
Weight

Technical data

FLM MP 5	FLM MP 7
360 mm	502 mm
	11 mm
	185 mm
	8.50 mm
For fastening the mounting plate	
For mounting 5 Fieldline Modular devices	For mounting 7 Fieldline Modular devices
Chromated aluminum	
650 g	900 g

Description
Fieldline Modular mounting plate - For five Fieldline Modular M12 devices - For seven Fieldline Modular M12 devices

Ordering data

Type	Order No.	Pcs. / Pkt.
FLM MP 5	2736660	1
FLM MP 7	2736673	1

System components

Various system components with M12 connectors enable the easy creation of different topologies.

- T-connectors
- Termination resistors
- Y-distributors for power and signal connections



Distributors and termination resistors

Ordering data			
Description	Type	Order No.	Pcs. / Pkt.
Bus system T-connector , 5-pos., M12 - PROFIBUS - DeviceNet™/CANopen®	SAC-M12T/2XM12 PBDP	1458884	1
	SAC-5P-M12T/2XM12 VP	1541186	1
PROFIBUS termination resistor - M12 pin design - M12 pin design	SAC-5P-M12MS PB TR	1507803	5
	SAC-5P-M12MS CAN TR	1507816	5
Power cable , 4-pos., PUR/PVC black, straight M12 Y-connector to 2x straight M12 sockets, length: 0.3 m	SAC-4P-M12Y/2X0,3-PUR/M12FS VP	1510722	1
	SAC-3P-M12Y/2XM12FS PE	1683455	5
M12 Y-distributor/connector , with M12 socket			
M12 connector to 2x M12 sockets			

Installation material

- Sealing caps with external or inner thread
- Printed marking labels or marking labels without color print



Sealing caps and marking material

Ordering data			
Description	Type	Order No.	Pcs. / Pkt.
M12 screw plug for non-assigned M12 sensor/actuator connections for unused M12 connectors of sensor/actuator cables, device connectors, and I/O devices in the field	PROT-M12	1680539	5
	PROT-M12 FS	1560251	5
M8 screw plug for unused M8 sockets of sensor/actuator cables, boxes, and device connectors	PROT-M8	1682540	5
Zack marker strip, flat, 5-section, without color print 5-section	ZBF 12:UNBEDRUCKT	0809735	10
	ZBF 8:UNBEDRUCKT	0808781	10
5-section	ZBF 12 CUS	0825018	1
	ZBF 8 CUS	0825030	1

For field installation (IP67) – Fieldline Modular

Bus and power cables with M12 connector

Phoenix Contact offers a complete range of bus and power cables for the Fieldline system.



INTERBUS bus cable



PROFINET bus cable



PROFIBUS bus cable



DeviceNet™/CANopen® bus cable

Description	Length of cable	Ordering data		Ordering data		Ordering data		Ordering data	
		Order No.	Pcs. / Pkt.	Order No.	Pcs. / Pkt.	Order No.	Pcs. / Pkt.	Order No.	Pcs. / Pkt.
Pre-assembled bus cable									
M12 pin, straight, shielded, free cable end									
	1 m			1407495	1				
	2 m	1517877	1	1407496	1	1518025	1	1518177	1
	5 m	1517880	1	1407497	1	1518038	1	1518180	1
	10 m	1517893	1	1407498	1	1518041	1	1518193	1
	15 m	1517903	1	1524336	1	1518054	1	1518203	1
Pre-assembled bus cable									
M12 socket, straight, shielded, free cable end									
	1 m			1407528	1				
	2 m	1517916	1	1407529	1	1518067	1	1518216	1
	5 m	1517929	1	1407530	1	1518070	1	1518229	1
	10 m	1517932	1	1407531	1	1518083	1	1518232	1
	15 m	1517945	1			1518096	1	1518245	1
Pre-assembled bus cable									
M12 pin, straight, shielded, M12 socket, straight, shielded									
	0.3 m	1517958	1			1518106	1	1518258	1
	0.5 m	1517961	1			1518119	1	1518261	1
	1 m	1517974	1	1407553	1	1518122	1	1518274	1
	2 m	1517987	1	1407554	1	1518135	1	1518287	1
	5 m	1517990	1	1407555	1	1518148	1	1518290	1
	10 m	1518009	1	1407556	1	1518151	1	1518300	1
	15 m	1518012	1			1518164	1	1518313	1
Pre-assembled bus cable									
M12 pin, straight, shielded, M12 pin, straight, shielded									
	0.3 m			1524349	1				
	0.5 m			1524352	1				
	1 m			1407524	1				
	2 m			1407525	1				
	5 m			1407526	1				
	10 m			1407527	1				
	15 m			1524404	1				

For field installation (IP67) – Fieldline Modular

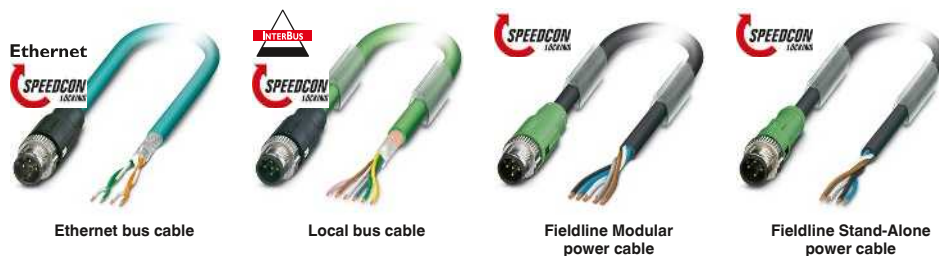

Description	Length of cable	Ordering data		Ordering data		Ordering data		Ordering data	
		Order No.	Pcs. / Pkt.	Order No.	Pcs. / Pkt.	Order No.	Pcs. / Pkt.	Order No.	Pcs. / Pkt.
Pre-assembled bus cable M12 pin, straight, shielded, free cable end	1 m	1407356	1						
	2 m	1407357	1	1517877	1				
	5 m	1407358	1	1517880	1				
	10 m	1407359	1	1517893	1				
	15 m	1569427	1	1517903	1				
Pre-assembled bus cable M12 socket, straight, shielded, free cable end	1 m	1407380	1						
	2 m	1407381	1	1517916	1				
	5 m	1407382	1	1517929	1				
	10 m	1407383	1	1517932	1				
	15 m			1517945	1				
Pre-assembled bus cable M12 pin, straight, shielded, M12 socket, straight, shielded	0.13 m			1518478	1				
	0.3 m			1517958	1				
	0.5 m			1517961	1				
	1 m	1407400	1	1517974	1				
	2 m	1407401	1	1517987	1				
	5 m	1407402	1	1517990	1				
	10 m	1407403	1	1518009	1				
	15 m			1518012	1				
Pre-assembled bus cable M12 pin, straight, shielded, M12 pin, straight, shielded	0.5 m	1569443	1						
	1 m	1407376	1						
	2 m	1407377	1						
	5 m	1407378	1						
	10 m	1407379	1						
Pre-assembled power cable M12 pin, straight, free cable end	2 m					1518326	1	1555606	1
	5 m					1518339	1	1555619	1
	10 m					1518342	1	1555622	1
	15 m					1518355	1	1555635	1
Pre-assembled power cable M12 socket, straight, free cable end	2 m					1518368	1	1555648	1
	5 m					1518371	1	1555651	1
	10 m					1518384	1	1555664	1
	15 m					1518397	1	1555677	1
Pre-assembled power cable M12 pin, straight, M12 socket, straight	0.13 m					1518481	1		
	0.3 m					1518407	1	1555680	1
	0.5 m					1518410	1	1555693	1
	1 m					1518423	1	1555703	1
	2 m					1518436	1	1555716	1
	5 m					1518449	1	1555729	1
	10 m					1518452	1	1555732	1
	15 m					1518465	1	1555745	1

For field installation (IP67) – Fieldline Modular

Bus and power cables with M8 connector

The following assembled cables are available for connecting Fieldline Modular M8 devices:

- System cables for the supply voltage and bus signal
- Power cables for the actuator voltage



Straight connector



Angled connector

Description	Length of cable	Ordering data			Ordering data			
		Type	Order No.	Pcs. / Pkt.	Type	Order No.	Pcs. / Pkt.	
Pre-assembled system cable M8 pin, straight, shielded, free cable end	2 m	SAC-4P-M 8MS/ 2,0-950	1543249	1				
	5 m	SAC-4P-M 8MS/ 5,0-950	1543252	1				
	10 m	SAC-4P-M 8MS/10,0-950	1543265	1				
	20 m	SAC-4P-M 8MS/20,0-950	1543281	1				
Pre-assembled system cable M8 pin, angled, shielded, free cable end	2 m				SAC-4P-M 8MR/ 2,0-950	1550850	1	
	5 m				SAC-4P-M 8MR/ 5,0-950	1550863	1	
	10 m				SAC-4P-M 8MR/10,0-950	1550876	1	
	20 m				SAC-4P-M 8MR/20,0-950	1550892	1	
Pre-assembled system cable M8 socket, straight, shielded, free cable end	2 m	SAC-4P- 2,0-950/M 8FS	1543294	1				
	5 m	SAC-4P- 5,0-950/M 8FS	1543304	1				
	10 m	SAC-4P-10,0-950/M 8FS	1543317	1				
	20 m	SAC-4P-20,0-950/M 8FS	1543333	1				
Pre-assembled system cable M8 socket, angled, shielded, free cable end	2 m				SAC-4P- 2,0-950/M 8FR	1550902	1	
	5 m				SAC-4P- 5,0-950/M 8FR	1550915	1	
	10 m				SAC-4P-10,0-950/M 8FR	1550928	1	
	20 m				SAC-4P-20,0-950/M 8FR	1550944	1	
Pre-assembled system cable M8 pin, straight, shielded, M8 socket, straight, shielded	0.13 m	SAC-4P-M 8MS/ 0,13-950/M 8FS	1543346	1				
	0.3 m	SAC-4P-M 8MS/ 0,3-950/M 8FS	1543511	1				
	0.5 m	SAC-4P-M 8MS/ 0,5-950/M 8FS	1543524	1				
	1 m	SAC-4P-M 8MS/ 1,0-950/M 8FS	1543537	1				
	2 m	SAC-4P-M 8MS/ 2,0-950/M 8FS	1543359	1				
	5 m	SAC-4P-M 8MS/ 5,0-950/M 8FS	1543362	1				
	10 m	SAC-4P-M 8MS/10,0-950/M 8FS	1543375	1				
	20 m	SAC-4P-M 8MS/20,0-950/M 8FS	1543391	1				
Pre-assembled system cable M8 pin, angled, shielded, M8 socket, angled, shielded	0.13 m				SAC-4P-M 8MR/ 0,13-950/M 8FR	1550957	1	
	0.3 m				SAC-4P-M 8MR/ 0,3-950/M 8FR	1550960	1	
	0.5 m				SAC-4P-M 8MR/ 0,5-950/M 8FR	1550973	1	
	1 m				SAC-4P-M 8MR/ 1,0-950/M 8FR	1550986	1	
	2 m				SAC-4P-M 8MR/ 2,0-950/M 8FR	1550999	1	
	5 m				SAC-4P-M 8MR/ 5,0-950/M 8FR	1551008	1	
	10 m				SAC-4P-M 8MR/10,0-950/M 8FR	1551011	1	
	20 m				SAC-4P-M 8MR/20,0-950/M 8FR	1551037	1	
	Pre-assembled power cable M8 socket, straight, free cable end, 4 x 0.34 mm ²	2 m	SAC-4P- 2,0-PUR/M 8FS 0,34	1543582	1			
		5 m	SAC-4P- 5,0-PUR/M 8FS 0,34	1534818	5			
10 m		SAC-4P-10,0-PUR/M 8FS 0,34	1543595	1				
20 m		SAC-4P-20,0-PUR/M 8FS 0,34	1543618	1				
Pre-assembled power cable M8 socket, angled, free cable end, 4 x 0.34 mm ²	2 m				SAC-4P- 2,0-PUR/M 8FR 0,34	1553077	1	
	5 m				SAC-4P- 5,0-PUR/M 8FR 0,34	1553080	1	
	10 m				SAC-4P-10,0-PUR/M 8FR 0,34	1553093	1	
	20 m				SAC-4P-20,0-PUR/M 8FR 0,34	1553116	1	

Connectors that can be assembled

Connectors that can be assembled enable the flexible cabling of Fieldline devices.

- M12 or M8 connection technology
- Shielded or unshielded
- Spring-cage, QUICKON or Piercecon connection



M12 connector



M8 connector

.FA ERIC

ERIC

Description	Ordering data			Ordering data		
	Type	Order No.	Pcs. / Pkt.	Type	Order No.	Pcs. / Pkt.
M12 connector, shielded M12 pin, 5-pos., A-coded, spring-cage connection	SACC-M12MS-5SC SH	1512555	1			
M12 pin, 5-pos., B-coded, spring-cage connection	SACC-M12MSB-5SC SH	1513570	1			
M12 pin, 4-pos., D-coded, QUICKON connection	SACC-M12MSD-4Q SH	1543223	1			
M12 socket, 5-pos., A-coded, spring-cage connection	SACC-M12FS-5SC SH	1512571	1			
M12 socket, 5-pos., B-coded, spring-cage connection	SACC-M12FSB-5SC SH	1513596	1			
M8 connector, shielded M8 pin, 4-pos., screw connection M8 socket, 4-pos., screw connection				SACC-M 8MS-4CON-M-0,34-SH SACC-M 8FS-4CON-M-0,34-SH	1542897 1542910	1 1
M12 connector, unshielded M12 pin, 4-pos., A-coded, QUICKON connection technology, cross section 0.14 - 0.34 mm ² , SPEEDCON quick locking system	SACC-MS-4QO-0,34-M SCO	1521575	1			
M12 socket, 4-pos., A-coded, QUICKON connection technology, cross section 0.14 - 0.34 mm ² , SPEEDCON quick locking system	SACC-FS-4QO-0,34-M SCO	1521588	1			
M12 pin, 4-pos., A-coded, QUICKON connection technology, cross section 0.34 - 0.75 mm ² , SPEEDCON quick locking system	SACC-MS-4QO-0,75-M SCO	1521591	1			
M12 socket, 4-pos., A-coded, QUICKON connection technology, cross section 0.34 - 0.75 mm ² , SPEEDCON quick locking system	SACC-FS-4QO-0,75-M SCO	1521601	1			
M12 pin, 5-pos., A-coded, spring-cage connection	SACC-M12MS-5SC M	1508187	1			
M12 socket, 5-pos., A-coded, spring-cage connection	SACC-M12FS-5SC M	1508200	1			
M8 connector, unshielded M8 pin, 3-pos., Piercecon® connection M8 socket, 4-pos., Piercecon® connection				SACC-M 8MS-3PCON SACC-M 8FS-4PCON	1506752 1506781	1 1

I/O systems

For field installation (IP67) – AS-Interface

Product overview

M12 I/O devices



Digital input 4 channels	2/2 channels	Digital input/output 4/3 channels	4/4 channels	Digital output 8 channels
260	261	261	261	260

M8 I/O devices



Digital input 4 channels	Digital output 4/4 channels
262	262

I/O devices in ME housing



Digital input/output		Digital output
4/4 channels	4/3 channels	4 channels
263	263	263

Gateways



PROFIBUS DP	
Standard function	Extended function
264	264



Inline Modular Standard function
265

Power supplies



Primary-switched	
2.4 A	4.8 A
266	266

Accessories – installation material

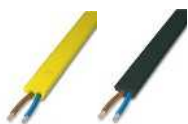

VS-ASI-FC-...
Flat-ribbon conductors

267



...ASI-...-FIX
Mounting material

267



Q 1,5/...-ASI BK
Panel feed-throughs

267



HC-M-KV-...
Screw connections

267



VS-ASI-J-Y-...
Distributors

268



VS-ASI-...-PUR-...M12...
Distributors with M12 round cable

268



VS-ASI-J-Y-...
Distributors with M12 connection

269



SAC-4P-...
M12 round cables

255



ASI CC ADR
Manual addressing device
for AS-i modules



ASI CC ADR CAB CINCH
Cinch connecting cable,
for addressing
FLX ASI M12 devices



PB ECO LINK
PROFIBUS ECO Link,
RS-232 PROFIBUS converter

phoenixcontact.net/products

For field installation (IP67) – AS-Interface

Digital I/O devices with M12 connection technology

The innovative locking mechanism enables quick and easy installation of the I/O devices.

Features:

- Optimized for direct mounting and DIN rail mounting
- Tool-free connection to AS-Interface using penetration technique
- M12 connection technology with SPEEDCON fast locking system for the I/Os



4 digital inputs



4 digital outputs

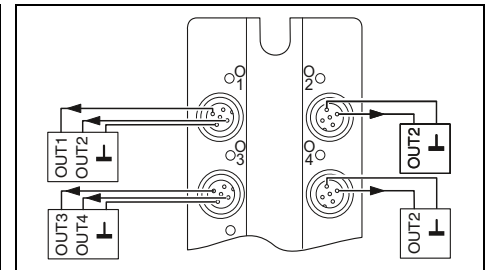
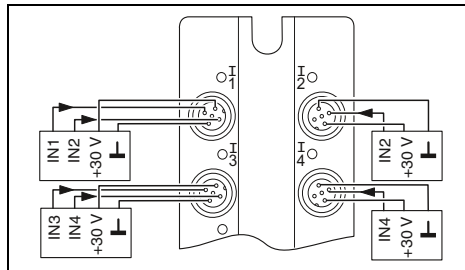

Technical data

Technical data

Interface	
Fieldbus system	AS-i
Connection method	Flat-ribbon cable penetration technique
AS-Interface	
AS-i specification	2.1
Required master specification	>= 2.0
AS-i profile	S-0.A.2
Digital inputs	
Connection method	M12 connector
Connection technology	2, 3-wire
Number of inputs	4
Input characteristic curve	IEC 61131-2 type 2
Digital outputs	
Connection method	-
Connection technology	-
Number of outputs	-
Maximum output current per channel	-
Maximum output current per module / terminal block	-
General data	
Weight	195 g
Drill hole spacing	108 mm
Dimensions	58 mm / 118 mm / 35 mm
Degree of protection	IP65/IP67
Ambient temperature (operation)	-25 °C ... 70 °C
EMC note	Class A product, see page 527

Interface	
Fieldbus system	AS-i
Connection method	Flat-ribbon cable penetration technique
AS-Interface	
AS-i specification	2.0
Required master specification	>= 2.0
AS-i profile	S-8.1
Digital inputs	
Connection method	-
Connection technology	-
Number of inputs	-
Input characteristic curve	-
Digital outputs	
Connection method	M12 connector
Connection technology	2-wire
Number of outputs	-
Maximum output current per channel	2 A
Maximum output current per module / terminal block	4 A
General data	
Weight	195 g
Drill hole spacing	108 mm
Dimensions	58 mm / 118 mm / 35 mm
Degree of protection	IP65/IP67
Ambient temperature (operation)	-25 °C ... 70 °C
EMC note	Class A product, see page 527

Ordering data

Ordering data

Description	Type	Order No.	Pcs. / Pkt.
Fieldline Extension AS-i digital input device			
- 4 inputs	FLX ASI DI 4 M12	2773429	1
Fieldline Extension AS-i digital output device			
- Four outputs, 2 A			
Fieldline Extension AS-i digital I/O device			
- 2 inputs, 2 outputs, 2 A			
- 4 inputs, 3 outputs, 2 A			
- 4 inputs, 4 outputs, 2 A			

Description	Type	Order No.	Pcs. / Pkt.
Fieldline Extension AS-i digital input device			
- 4 inputs	FLX ASI DI 4 M12	2773429	1
Fieldline Extension AS-i digital output device			
- Four outputs, 2 A	FLX ASI DO 4 M12-2A	2773458	1

Accessories

Accessories

M12 screw plug	PROT-M12	1680539	5
Label sheet for laser printers, 64 x 16 mm, color: White	BMKL 64X16 WH	0821807	2
Label sheet for laser printers, 108 x 16 mm, color: White			
Manual addressing device , for AS-Interface devices	ASI CC ADR	2741338	1
Programming cable , for addressing the AS-i devices	ASI CC ADR CAB CINCH	2741341	1

M12 screw plug	PROT-M12	1680539	5
Label sheet for laser printers, 64 x 16 mm, color: White	BMKL 64X16 WH	0821807	2
Label sheet for laser printers, 108 x 16 mm, color: White			
Manual addressing device , for AS-Interface devices	ASI CC ADR	2741338	1
Programming cable , for addressing the AS-i devices	ASI CC ADR CAB CINCH	2741341	1



2 digital inputs and 2 digital outputs



4 digital inputs and 3 digital outputs



4 digital inputs and 4 digital outputs

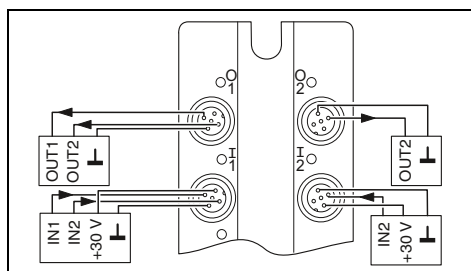

Technical data

AS-i
Flat-ribbon cable penetration technique

2.1
≥ 2.0
S-B.A.2

M12 connector
2, 3-wire
2
IEC 61131-2 type 2

M12 connector
2-wire
2
2 A
4 A

195 g
108 mm
58 mm / 118 mm / 35 mm
IP65/IP67
-25 °C ... 70 °C
Class A product, see page 527

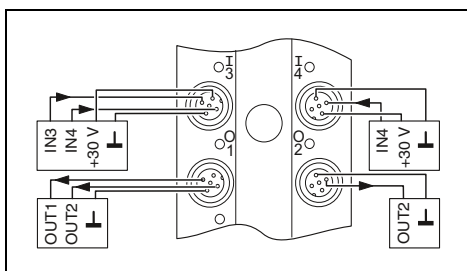

Technical data

AS-i
Flat-ribbon cable penetration technique

2.1
≥ 2.0
S-7.A.2

M12 connector
2, 3-wire
4
IEC 61131-2 type 2

M12 connector
2-wire
3
2 A
4 A

245 g
108 mm
58 mm / 150 mm / 35 mm
IP65/IP67
-25 °C ... 70 °C
Class A product, see page 527

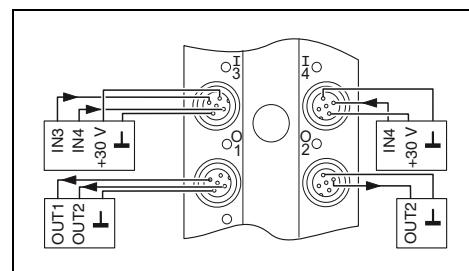

Technical data

AS-i
Flat-ribbon cable penetration technique

3.0
≥ 3.0
S-7.A.7

M12 connector
2, 3-wire
4
IEC 61131-2 type 2

M12 connector
2-wire
4
2 A

245 g
108 mm
58 mm / 150 mm / 35 mm
IP65/IP67
-25 °C ... 70 °C
Class A product, see page 527

Ordering data

Type	Order No.	Pcs. / Pkt.
FLX ASI DIO 2/2 M12-2A	2773432	1

Accessories

PROT-M12	1680539	5
BMKL 64X16 WH	0821807	2
ASI CC ADR	2741338	1
ASI CC ADR CAB CINCH	2741341	1

Ordering data

Type	Order No.	Pcs. / Pkt.
FLX ASI DIO 4/3 M12-2A	2773445	1

Accessories

PROT-M12	1680539	5
BMKL 11,5 (108X16) WH	0821797	2
ASI CC ADR	2741338	1
ASI CC ADR CAB CINCH	2741341	1

Ordering data

Type	Order No.	Pcs. / Pkt.
FLX ASI 3.0 DIO 4/4 M12-2A	2773474	1

Accessories

PROT-M12	1680539	5
BMKL 11,5 (108X16) WH	0821797	2
ASI CC ADR	2741338	1
ASI CC ADR CAB CINCH	2741341	1

I/O systems

For field installation (IP67) – AS-Interface

Digital I/O devices with M8 connection technology

The digital I/O devices are particularly suitable for use in machines close to the process.

Features:

- Optimized for 30 mm mounting profile
- M12 connection technology with SPEEDCON fast locking system for the AS-Interface connection
- M8 connection technology for the I/Os



4 digital inputs



4 digital inputs and 4 digital outputs

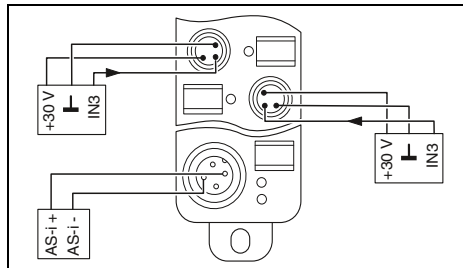

Technical data

Interface	
Fieldbus system	AS-i
Connection method	M12 connector (A-coded)
AS-Interface	
AS-i specification	2.0
Required master specification	>= 2.0
AS-i profile	S-0.0
Digital inputs	
Connection method	M8 connector
Connection technology	2, 3-wire
Number of inputs	4
Input characteristic curve	IEC 61131-2 type 2
Digital outputs	
Connection method	-
Connection technology	-
Number of outputs	-
Maximum output current per channel	-
Maximum output current per module / terminal block	-
General data	
Weight	85 g
Drill hole spacing	93 mm
Dimensions	W / H / D 30 mm / 26 mm / 103 mm
Degree of protection	IP65/IP67
Ambient temperature (operation)	-25 °C ... 70 °C
EMC note	Class A product, see page 527

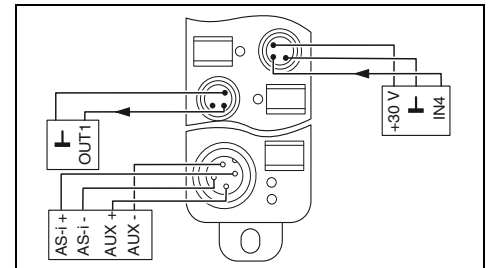

Technical data

Interface	
Fieldbus system	AS-i
Connection method	M12 connector (A-coded)
AS-Interface	
AS-i specification	2.0
Required master specification	>= 2.0
AS-i profile	S-7.0
Digital inputs	
Connection method	M8 connector
Connection technology	2, 3-wire
Number of inputs	4
Input characteristic curve	IEC 61131-2 type 2
Digital outputs	
Connection method	M8 connector
Connection technology	2-wire
Number of outputs	4
Maximum output current per channel	1 A
Maximum output current per module / terminal block	4 A
General data	
Weight	125 g
Drill hole spacing	133 mm
Dimensions	W / H / D 30 mm / 26 mm / 143 mm
Degree of protection	IP65/IP67
Ambient temperature (operation)	-25 °C ... 70 °C
EMC note	Class A product, see page 527

Ordering data

Description	
Fieldline Extension AS-i digital input device	
- 4 inputs	
Fieldline Extension AS-i digital I/O device	
- 4 inputs, 4 outputs, 1 A	

Type	Order No.	Pcs. / Pkt.
FLX ASI DI 4 M8	2773403	1

Accessories

M8 screw plug	PROT-M8	1682540	5
Zack marker strip, flat, 10-section, without color print	ZBF 8:UNBEDRUCKT	0808781	10
Manual addressing device, for AS-Interface devices	ASI CC ADR	2741338	1

Type	Order No.	Pcs. / Pkt.
FLX ASI DIO 4/4 M8-1A	2773416	1

Ordering data

Type	Order No.	Pcs. / Pkt.
FLX ASI DIO 4/4 M8-1A	2773416	1

Accessories

M8 screw plug	PROT-M8	1682540	5
Zack marker strip, flat, 10-section, without color print	ZBF 8:UNBEDRUCKT	0808781	10
Manual addressing device, for AS-Interface devices	ASI CC ADR	2741338	1

Digital I/O devices with COMBICON connection technology

The slim digital I/O devices in the ME range are particularly suitable for use in the control cabinet.

Features:

- 12.5 mm overall width
- Optimized for DIN rail mounting
- COMBICON connection technology for AS-Interface
- COMBICON connection technology for the I/Os



4 digital inputs



4 digital inputs and 3/4 digital outputs



Technical data

Interface	
Fieldbus system	AS-i
Connection method	COMBICON connectors
AS-Interface	
AS-i specification	2.1
Required master specification	>= 2.0
AS-i profile	S-0.A.0
Digital inputs	
Connection method	COMBICON connectors
Connection technology	2, 3-wire
Number of inputs	4
Digital outputs	
Connection method	-
Connection technology	-
Number of outputs	-
Maximum output current per channel	-
Maximum output current per module / terminal block	-
General data	
Weight	150 g
Dimensions	W / H / D 22.5 mm / 102 mm / 105 mm
Degree of protection	IP20
Ambient temperature (operation)	-25 °C ... 60 °C
EMC note	Class A product, see page 527



Technical data

ASI IO ME DIO 4/4 AB	ASI IO ME DIO 4/3 AB
AS-i	
COMBICON connectors	
3.0	2.1
>= 3.0	>= 2.0
S-7.A.7	S-7.A.0
COMBICON connectors	
2, 3-wire	2, 3-wire
4	4
COMBICON connectors	
2-wire	2, 3-wire
4	3
0.7 A	1.5 A
2.8 A	6 A
General data	
Weight	
150 g	
Dimensions	
22.5 mm / 102 mm / 105 mm	
Degree of protection	
IP20	
Ambient temperature (operation)	
-25 °C ... 60 °C	
EMC note	
Class A product, see page 527	

Ordering data

Description	Type	Order No.	Pcs. / Pkt.
Fieldline Extension AS-i digital input device, including COMBICON connector - 4 inputs	ASI IO ME DI 4 AB	2741671	1
Fieldline Extension AS-i digital I/O device, including COMBICON connector - 4 inputs, 4 outputs - 4 inputs, 3 outputs			

Ordering data

Type	Order No.	Pcs. / Pkt.
ASI IO ME DIO 4/4 AB	2773542	1
ASI IO ME DIO 4/3 AB	2741668	1

Accessories

Manual addressing device, for AS-Interface devices	ASI CC ADR	2741338	1
Programming cable, for addressing the AS-i devices	ASI CC ADR CAB CINCH	2741341	1

Accessories

ASI CC ADR	2741338	1
ASI CC ADR CAB CINCH	2741341	1

Gateways for PROFIBUS DP

Fieldline Extension AS-Interface gateways enable the easy integration of AS-Interface into a PROFIBUS DP system.

Features:

- AS-Interface specification 3.0
- For one or two AS-Interface networks
- Stainless steel housing
- IP20 protection



Standard function



Extended function, double master



		Technical data			Technical data		
Interfaces		1x D-SUB-9 connector			1x D-SUB-9 connector		
PROFIBUS DP remote bus		2-pos. COMBICON connector			2 x 2-pos. COMBICON connector		
AS-Interface		approx. 200 mA (from the AS-i network)			approx. 200 mA (from AS-i circuit 1)		
Power supply							
Typical current consumption							
Indicators		Green LED			Green LED		
Operating voltage, module electronics		Green LED			Green LED		
Operating voltage, AS-i		Green LED			Green LED		
AS-i transmission		Green LED			Green LED		
Programming mode active, automatic slave programming possible		Green LED			Green LED		
Configuration mode active		Yellow LED			Yellow LED		
AS-i configuration error		Red LED			Red LED		
AS-Interface							
Number of AS-i slaves		62			62		
AS-i specification		3.0			3.0		
Operating elements		2 buttons (Mode/Set) for configuring the AS-i network			4 buttons (Mode/Set/ESC/OK) for configuring the AS-i network		
Keys							
General data							
Weight		300 g			460 g		
Dimensions		W / H / D 45 mm / 120 mm / 44 mm			75 mm / 120 mm / 83 mm		
Degree of protection		IP20			IP20		
Ambient temperature (operation)		0 °C ... 55 °C			0 °C ... 55 °C		
Ambient temperature (storage/transport)		-25 °C ... 85 °C			-25 °C ... 85 °C		
		Ordering data			Ordering data		
Description		Type	Order No.	Pcs. / Pkt.	Type	Order No.	Pcs. / Pkt.
Fieldline Extension AS-i gateway for PROFIBUS DP							
- With standard function		FLX ASI MA PB SF	2773597	1	FLX ASI MA 2 PB EF	2773607	1
- With extended function, double master							
		Accessories			Accessories		
PROFIBUS ECO Link, RS-232 PROFIBUS converter, incl. software for PC		PB ECO LINK	2741480	1	PB ECO LINK	2741480	1

Gateway for Inline Modular

When used in combination with an appropriate Inline bus coupler, the AS-Interface gateway for Inline enables universal integration into the following networks, for example:

- INTERBUS
- PROFINET
- PROFIBUS
- CANopen®
- DeviceNet™
- EtherNet/IP™

Notes:

The driver function blocks can be obtained free of charge on the Internet at phoenixcontact.net/products under Download on the product page of the corresponding module.



Standard function

Technical data			
Interfaces			
Inline local bus	Inline data jumper		
AS-Interface	Inline connector		
Power supply			
Typical current consumption	200 mA (from the AS-i network)		
Indicators			
Local bus diagnostics	Green LED		
Operating voltage, AS-i	Green LED		
PCP communication	Green LED		
Automatic address programming active	Green LED		
Configuration mode active	Yellow LED		
AS-i configuration error	Red LED		
AS-Interface			
Number of AS-i slaves	62		
AS-i specification	2.1		
Operating elements			
Keys	2 buttons (Mode/Set) for configuring the AS-i network		
General data			
Amount of PCP data	1 word		
Weight	210 g		
Dimensions	W / H / D 73.2 mm / 119.8 mm / 71.5 mm		
Degree of protection	IP20		
Ambient temperature (operation)	-25 °C ... 55 °C		
Ambient temperature (storage/transport)	-25 °C ... 85 °C		
Ordering data			
Description	Type	Order No.	Pcs. / Pkt.
Fieldline Extension AS-i gateway for Inline Modular	ASI MA IL UNI	2736628	1

Power supply units

The power supply units specially designed for AS-Interface offer the following features:

- 2.4 A or 4.8 A nominal output current
- Integrated ground fault detector
- Wide-range input for operation on all common AC and DC networks



2.4 A



4.8 A

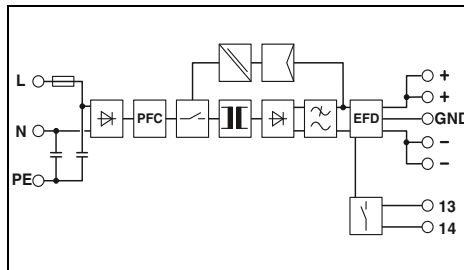

Technical data

Input data	100 V AC ... 240 V AC
Nominal input voltage	45 Hz ... 65 Hz / 0 Hz
Frequency range	approx. 1 A (120 V AC) / 0.5 A (230 V AC)
Current consumption (nominal load)	< 15 A / 2.2 A ^{2s}
Inrush current limitation at 25°C (typ.) / I _{2t}	> 20 ms (120 V AC) / > 80 ms (230 V AC)
Mains buffering (I _N , typ.)	< 0.5 s
Switch-on time after applying the mains voltage	5 A (slow-blow, internal)
Input fuse	
Output data	
Nominal output voltage	30.1 V DC ±1.5 %
Output current	2.4 A / 3 A
Output current / Max. output current	2.4 A / - 3 A
Max. power dissipation (no load/nominal load)	3 W / 11 W
Residual ripple	< 30 mV _{pp}
Signaling	
Signaling DC OK	LED
Signaling EFD	LED, relay contact
General data	
Weight / Dimensions W x H x D	0.75 kg / 55 x 145 x 125 mm
Installation position	Horizontal DIN rail NS 35, EN 60715
Spacing when mounting	Can be aligned: horizontally 0 mm, vertically 50 mm
Connection method	Plug-in spring-cage connection
Degree of protection	IP20
MTBF (IEC 61709, SN 29500)	> 50,000 h
Type of housing	AluNox (AlMg1)
Ambient temperature (operation)	-25 °C ... 70 °C (> 60 °C Derating: 2.5 %/K)
Ambient temperature (storage/transport)	-40 °C ... 85 °C
UL approvals	UL/C-UL Listed UL 508, UL/C-UL Recognized UL 60950

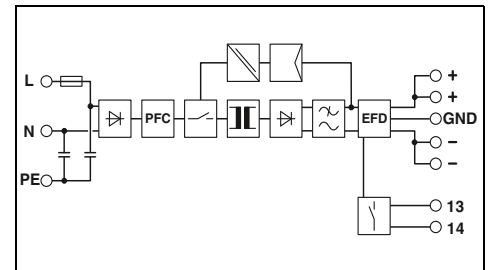

Technical data

Input data	100 V AC ... 240 V AC
Nominal input voltage	45 Hz ... 65 Hz / 0 Hz
Frequency range	approx. 1.8 A (120 V AC) / 1 A (230 V AC)
Current consumption (nominal load)	< 15 A / 2.2 A ^{2s}
Inrush current limitation at 25°C (typ.) / I _{2t}	> 60 ms (120 V AC) / > 100 ms (230 V AC)
Mains buffering (I _N , typ.)	< 0.5 s
Switch-on time after applying the mains voltage	5 A (slow-blow, internal)
Input fuse	
Output data	
Nominal output voltage	30.1 V DC ±1.5 %
Output current	4.8 A / 6 A
Output current / Max. output current	4.8 A / - 6 A
Max. power dissipation (no load/nominal load)	4 W / 16 W
Residual ripple	< 30 mV _{pp}
Signaling	
Signaling DC OK	LED
Signaling EFD	LED, relay contact
General data	
Weight / Dimensions W x H x D	0.9 kg / 70 x 145 x 125 mm
Installation position	Horizontal DIN rail NS 35, EN 60715
Spacing when mounting	Can be aligned: horizontally 0 mm, vertically 50 mm
Connection method	Plug-in spring-cage connection
Degree of protection	IP20
MTBF (IEC 61709, SN 29500)	> 50,000 h
Type of housing	AluNox (AlMg1)
Ambient temperature (operation)	-25 °C ... 70 °C (> 60 °C Derating: 2.5 %/K)
Ambient temperature (storage/transport)	-40 °C ... 85 °C
UL approvals	UL/C-UL Listed UL 508, UL/C-UL Recognized UL 60950

Ordering data

Description	Type	Order No.	Pcs. / Pkt.
Power supply unit, primary-switched	ASI QUINT 100-240/2.4 EFD	2736686	1

Ordering data

Description	Type	Order No.	Pcs. / Pkt.
Power supply unit, primary-switched	ASI QUINT 100-240/4.8 EFD	2736699	1

Flat-ribbon conductors, flat-ribbon conductor connectors and panel feed-throughs

Applications can be implemented in a wide range of fields thanks to the four different flat-ribbon conductor materials.

Components, e.g., with QUICKON fast connection technology, are available to connect or feed through these flat-ribbon conductors.



Flat-ribbon conductors and accessories



Flat-ribbon conductors and panel feed-throughs with QUICKON fast connection technology



			Technical data			Technical data		
			VS-ASI-FC-PVC...	VS-ASI-FC-PUR...	Q 1,5/4IDC	Q 1,5/4M20		
Mechanical data								
Number of positions			2	2	4	4		
Degree of protection			-	-	IP65/IP67	IP65/IP67		
Cable data								
Outer sheath material			PVC	PUR	-	-		
Conductor cross section			1.5 mm ²	1.5 mm ²	-	-		
Connector data, QUICKON connection								
Conductor cross section [mm ²]			-	-	0.75 mm ² ... 1.5 mm ²	0.75 mm ² ... 1.5 mm ²		
Conductor cross section [AWG]			-	-	18 ... 16	18 ... 16		
Temperature data								
Connector/socket	[°C]		-	-	-25 ... 80	-25 ... 80		
Cable, fixed installation	[°C]		-30 ... 90	-40 ... 85	-	-		
Cable, flexible installation	[°C]		-20 ... 90	-30 ... 85	-	-		
			Ordering data			Ordering data		
Description	Cable length		Type	Order No.	Pcs. / Pkt.	Type	Order No.	Pcs. / Pkt.
AS-Interface EPDM flat-ribbon conductor, 2 x 1.5 mm²								
Yellow	100 m		VS-ASI-FC-EPDM-YE 100M	1432402	1			
Yellow	1000 m		VS-ASI-FC-EPDM-YE 1000M	1434646	1			
Black	100 m		VS-ASI-FC-EPDM-BK 100M	1432415	1			
Black	1000 m		VS-ASI-FC-EPDM-BK 1000M	1434659	1			
AS-Interface PVC flat-ribbon conductor to UL, 2 x 1.5 mm²								
Yellow	100 m		VS-ASI-FC-PVC-UL-YE 100M	1404906	1			
Yellow	1000 m		VS-ASI-FC-PVC-UL-YE/1000	1404867	1			
Black	100 m		VS-ASI-FC-PVC-UL-BK 100M	1404919	1			
Black	1000 m		VS-ASI-FC-PVC-UL-BK/1000	1404870	1			
AS-Interface TPE flat-ribbon conductor to UL, 2 x 1.5 mm²								
Yellow	100 m		VS-ASI-FC-TPE-UL-YE 100M	1404922	1			
Yellow	1000 m		VS-ASI-FC-TPE-UL-YE 1000M	1434662	1			
Black	100 m		VS-ASI-FC-TPE-UL-BK 100M	1404935	1			
Black	1000 m		VS-ASI-FC-TPE-UL-BK 1000M	1434675	1			
AS-Interface PUR flat-ribbon conductor, 2 x 1.5 mm²								
Yellow	100 m		VS-ASI-FC-PUR-YE 100M	1404883	1			
Yellow	1000 m		VS-ASI-FC-PUR-YE/1000	1404841	1			
Black	100 m		VS-ASI-FC-PUR-BK 100M	1404896	1			
Black	1000 m		VS-ASI-FC-PUR-BK/1000	1404854	1			
Flat connector, 4-pos., for connecting one or two AS-i flat-ribbon conductors								
Panel feed-through, for accommodating one or two AS-i flat-ribbon conductors, on the rear side with manual solder/slip-on connection 4.8 x 0.8 mm						Q 1,5/4IDC/24-24KU-KU-ASI-BK	1585058	1
Panel feed-through, for accommodating one or two AS-Interface flat-ribbon conductors, on the rear side with four individual 1.5 mm² wires						Q 1,5/4FL/24-M20KU-ESA-ASI BK	1437261	1
Metal gland, for AS-Interface flat-ribbon conductor						Q 1,5/4A50/24-M20KU-ESA-ASI BK	1437274	1
Thread type: M20						HC-M-KV-M20(1ASI)	1584017	10
Thread type: M25						HC-M-KV-M25(1ASI)	1584020	10

For field installation (IP67) – AS-Interface

Distributor with spring-cage connection and with round conductors

Thanks to the distributors, it is extremely easy to create various topologies.

The following combinations are available:

- Flat-ribbon conductor to spring-cage terminal block
- Flat-ribbon conductor to flat-ribbon conductor
- Flat-ribbon conductor to round cable



Flat-ribbon conductor distributors and distributors with spring-cage connection



Distributor with round cable and molded M12 connector with SPEEDCON

		Technical data		Technical data			
		SAC-ASI-J-Y-B...	VS-ASI-J-Y-Y-N	SAC-ASI-J-Y-N...	SAC-ASI-J-Y-B...		
Electrical data							
Rated voltage		≤ 35 V	≤ 35 V	≤ 35 V	≤ 35 V		
Rated current		≤ 6 A	≤ 8 A	≤ 4 A	≤ 4 A		
Material specifications for exit							
Material of grip body		-	-	TPU	TPU		
Material specifications for distributor							
Housing material		PA-GF	PA-GF	PA-GF	PA-GF		
Mechanical data							
Number of positions		4	4	2	4		
Degree of protection		IP20	IP65/IP67/IP69K	IP65/IP67	IP65/IP67		
Connection data for spring-cage terminal blocks							
Conductor cross section		0.2 mm ² ... 1.5 mm ²	-	-	-		
Connection cross section AWG		24 ... 16	-	-	-		
Cable data							
Outer sheath material		-	-	PUR	PUR		
External cable diameter		-	-	4.70 mm	4.70 mm		
Conductor cross section		-	-	0.34 mm ²	0.34 mm ²		
Temperature data							
Connector/socket	[°C]	-25 ... 75	-25 ... 75	-25 ... 75	-25 ... 75		
Cable, fixed installation	[°C]	-	-	-40 ... 80	-40 ... 80		
Cable, flexible installation	[°C]	-	-	-25 ... 80	-25 ... 80		
		Ordering data		Ordering data			
Description	Cable length	Type	Order No.	Pcs. / Pkt.	Type	Order No.	Pcs. / Pkt.
AS-Interface distributor with IP20 degree of protection for two flat conductors , 4-pos., with spring-cage terminal blocks		VS-ASI-J-Y-B-FFKDS	1404498	1			
AS-Interface H-distributor with high degree of protection, for distribution from one to two flat-ribbon conductors		VS-ASI-J-Y-Y-N	1404508	1			
AS-Interface distributor with IP67 protection for one flat-ribbon conductor , with PUR round cable and molded, straight , A-coded, 2-pos. M12 socket with SPEEDCON	1 m 2 m				VS-ASI-J-Y-N-PUR-1,0-M12FS SCO VS-ASI-J-Y-N-PUR-2,0-M12FS SCO	1404430 1404443	1 1
AS-Interface distributor with IP67 protection for two flat connectors , with PUR round cable and molded, straight , A-coded, 4-pos. M12 socket with SPEEDCON	1 m 2 m				VS-ASI-J-Y-B-PUR-1,0-M12FS SCO VS-ASI-J-Y-B-PUR-2,0-M12FS SCO	1404456 1404472	1 1
AS-Interface distributors with IP67 protection for two flat connectors , with PUR round cable and molded, angled , A-coded, 4-pos. M12 socket with SPEEDCON	1 m 2 m				VS-ASI-J-Y-B-PUR-1,0-M12FR SCO VS-ASI-J-Y-B-PUR-2,0-M12FR SCO	1404469 1404485	1 1

Distributors with M12 sockets, with screw connection, pre-assembled round conductors

Thanks to the distributors, it is extremely easy to create various topologies.

The following combinations are available:

- Flat-ribbon conductor to M12 socket
- Flat-ribbon conductor to screw connection



Distributors with M12 slot and with screw connection



PUR round conductors with molded M12-SPEEDCON connectors



	Technical data			Technical data			
	VS-ASI-J-Y-N-M12FS	VS-ASI-J-Y-N-SWA-LC	-				
Material data							
Housing material	PA-GF	PA	-				
Material of grip body	-	-	-			TPU, hardly inflammable, self-extinguishing	
Number of positions	2	2	4				
Degree of protection	IP65/IP67/IP69K	IP67	IP65/IP67				
Connection data for screw connection							
Conductor cross section	-	0.14 mm ² ... 1 mm ² (solid)	-				
Connection cross section AWG	-	26 ... 17 (solid)	-				
Conductor cross section	-	0.14 mm ² ... 0.75 mm ² (with ferrules)	-				
Connection cross section AWG	-	26 ... 18 (with ferrules)	-				
Cable data							
Conductor cross section	-	-	0.75 mm ²				
Temperature data							
Connector/socket	[°C]	-25 ... 75	-25 ... 70	[°C]		-25 ... 90	
Cable, fixed installation	[°C]	-	-	[°C]		-25 ... 80	
Cable, flexible installation	[°C]	-	-	[°C]		-5 ... 80	
	Ordering data			Ordering data			
Description	Cable length	Type	Order No.	Pcs. / Pkt.	Type	Order No.	Pcs. / Pkt.
AS-Interface distributor for flat-ribbon conductors, with straight, A-coded M12 socket							
One flat conductor, 2-pos.		VS-ASI-J-Y-N-M12FS	1404414	1			
Two flat conductors, 4-pos.		VS-ASI-J-Y-B-M12FS	1404427	1			
AS-Interface distributor , with straight, A-coded M12 socket							
One flat conductor, 2-pos.		VS-ASI-J-Y-N-M12FS-LC	1433155	1			
AS-Interface distributor , with screw connection, angled							
One flat conductor, 2-pos.		VS-ASI-J-Y-N-SWA-LC	1433168	1			
Pre-assembled round conductor							
M12 pin, straight, free cable end	2 m				SAC-4P-MS/ 2,0-186 SCO	1555606	1
	5 m				SAC-4P-MS/ 5,0-186 SCO	1555619	1
	10 m				SAC-4P-MS/10,0-186 SCO	1555622	1
	15 m				SAC-4P-MS/15,0-186 SCO	1555635	1
Pre-assembled round conductor							
M12 socket, straight, free cable end	2 m				SAC-4P- 2,0-186/FS SCO	1555648	1
	5 m				SAC-4P- 5,0-186/FS SCO	1555651	1
	10 m				SAC-4P-10,0-186/FS SCO	1555664	1
	15 m				SAC-4P-15,0-186/FS SCO	1555677	1
Pre-assembled round conductor							
M12 pin, straight, M12 socket, straight	0.3 m				SAC-4P-MS/ 0,3-186/FS SCO	1555680	1
	0.5 m				SAC-4P-MS/ 0,5-186/FS SCO	1555693	1
	1 m				SAC-4P-MS/ 1,0-186/FS SCO	1555703	1
	2 m				SAC-4P-MS/ 2,0-186/FS SCO	1555716	1
	5 m				SAC-4P-MS/ 5,0-186/FS SCO	1555729	1
	10 m				SAC-4P-MS/10,0-186/FS SCO	1555732	1
	15 m				SAC-4P-MS/15,0-186/FS SCO	1555745	1

Fieldline Stand-Alone

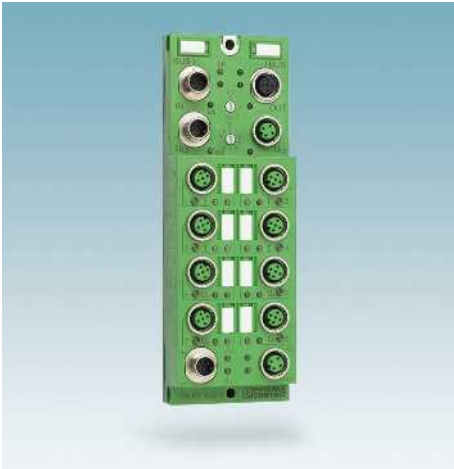

Fieldline Stand-Alone is an I/O system with a block design for field installation. Open to all common fieldbus systems, Fieldline Stand-Alone is optimized for the acquisition of digital signals directly in the field. The I/O system has a compact design and is versatile when it comes to mounting.

Your advantages:

- Flexible mounting, thanks to lateral and front mounting options
- Bus addresses can be set easily using rotary coding switches
- Ergonomic slot arrangement simplifies installation
- Integrated FE connection concept enables safe network operation

Find out more with the web code

Detailed information on these products can be found on our website. Simply enter # and numbers in the search field.

i Your web code: #0287

Notes:

A comprehensive range of installation materials for field installation can be found on page 252



Distributed I/O system with a block design

Description

Fieldline Stand-Alone digital I/O devices for INTERBUS M12

- 8 inputs
- 16 inputs
- 4 inputs, 4 outputs
- 8 inputs, 8 outputs
- 8 outputs

Fieldline Stand-Alone digital I/O devices for PROFIBUS M12

- 8 inputs
- 16 inputs
- 4 inputs, 4 outputs
- 8 inputs, 8 outputs
- 8 outputs
- IO-Link master with 4 IO-Link ports

Fieldline Stand-Alone digital I/O devices for DeviceNet™ M12

- 8 inputs
- 16 inputs
- 4 inputs, 4 outputs
- 8 inputs, 8 outputs
- 8 outputs

Fieldline Stand-Alone digital I/O devices for CANopen® M12

- 8 inputs
- 16 inputs
- 4 inputs, 4 outputs
- 8 inputs, 8 outputs
- 8 outputs

Ordering data

Type	Order No.	Pcs. / Pkt.
FLS IB M12 DI 8 M12	2736013	1
FLS IB M12 DI 16 M12	2736314	1
FLS IB M12 DIO 4/4 M12-2A	2736026	1
FLS IB M12 DIO 8/8 M12	2736385	1
FLS IB M12 DO 8 M12-2A	2736039	1
FLS PB M12 DI 8 M12	2736123	1
FLS PB M12 DI 16 M12	2736220	1
FLS PB M12 DIO 4/4 M12-2A	2736107	1
FLS PB M12 DIO 8/8 M12	2736372	1
FLS PB M12 DO 8 M12-2A	2736110	1
FLS PB M12 IOL 4 M12	2736987	1
FLS DN M12 DI 8 M12	2736068	1
FLS DN M12 DI 16 M12	2736327	1
FLS DN M12 DIO 4/4 M12-2A	2736042	1
FLS DN M12 DIO 8/8 M12	2736398	1
FLS DN M12 DO 8 M12-2A	2736055	1
FLS CO M12 DI 8 M12	2736097	1
FLS CO M12 DI 16 M12	2736479	1
FLS CO M12 DIO 4/4 M12-2A	2736071	1
FLS CO M12 DIO 8/8 M12	2736482	1
FLS CO M12 DO 8 M12-2A	2736084	1

Ruggedline



Distributed I/O system
for the automotive body shop

The robust I/O devices with a block design are ideal for use in harsh industrial environments. They are available for INTERBUS and PROFINET systems. The I/O system was specially developed for body shop requirements in the automotive industry.

Your advantages:

- Safe communication even in environments subject to high levels of electromagnetic interference, thanks to data transmission via fiber optics
- Snap-in mounting plate assembly without the use of tools makes installation easier
- Particularly resistant to welding splash and mechanical damage
- Developed specifically for body shop requirements in the automotive industry

Find out more with the web code

Detailed information on these products can be found on our website. Simply enter # and numbers in the search field.

 Your web code: #0288

Description
Ruggedline devices for PROFINET
- Monitoring device, FO connection
- 16 inputs, twisted pair connection
- 8 inputs, 8 I/Os, twisted pair connection
- 8 inputs, 8 outputs, FO connection
Ruggedline devices for INTERBUS
- BK module, FO connection
- BK module, twisted pair connection
- Monitoring device, FO connection
- 16 inputs, FO connection
- 16 inputs, twisted pair connection
- 4 inputs, 2 outputs, FO connection
- 8 inputs, 8 outputs, FO connection
- 8 inputs, 8 readback outputs, FO connection
- 8 inputs, 8 outputs, twisted pair connection
- 8 readback outputs, FO connection
- 8 outputs, 2 A, FO connection
- 8 outputs, 2 A, twisted pair connection
- Motor starter, 400 V, 6 inputs, 1 output, FO connection
- Motor starter, 480 V, 6 inputs, 1 output, FO connection

Ordering data			
Type	Order No.	Pcs. / Pkt.	
RL PN 24-2 OC 2SCRJ	2700654	1	
RL PN 24-2 DI 16 2TX	2773665	1	
RL PN 24-2 DIO 16/8 2TX	2773652	1	
RL PN 24-2 DIO 8/8 2SCRJ	2773513	1	
IBS RL 24 BK RB-LK-LK	2725024	1	
IBS RL 24 BK RB-T-T	2731063	1	
IBS RL 24 OC-LK	2819972	1	
IBS RL 24 DI 16/8-LK	2724850	1	
IBS RL 24 DI 16/8-T	2836463	1	
IBS RL 24 DIO 4/2/4-LK	2819985	1	
IBS RL 24 DIO 8/8-8-LK	2724847	1	
IBS RL 24 DIO 8/8/8-R-LK	2734167	1	
IBS RL 24 DIO 8/8/8-T	2836476	1	
IBS RL 24 DO 16/8-R-LK	2734170	1	
IBS RL 24 DO 8/8-2A-LK	2731034	1	
IBS RL 24 DO 8/8-2A-T	2731856	1	
IBS RL 400 MLR R DIO6/1 LK	2734769	1	
IBS RL 480 MLR R DIO6/1-LK	2737384	1	



Industrial Ethernet

Make the most of all the options offered by your Ethernet network.

Phoenix Contact offers you more realtime, more wireless, more safety, and more reliability.

Industrial Ethernet from Phoenix Contact can be easily integrated in your automation infrastructure - because we make Ethernet easy.

Benefit from our experience in automation which spans decades and the experience we have gained in industrial Ethernet networks over the past ten plus years.

We know and understand the expectations and demands placed on automation. This is evident and embodied in our products and solutions.

Product overview	274
<hr/>	
Unmanaged Switches	
- Standard switches with basic functions	276
- Standard switches	279
- Standard Gigabit switches	282
- Standard switches with wide temperature range	284
- Standard switches with flat design	286
- Hubs, IP67 switches, and Power over Ethernet	289
<hr/>	
Managed Switches	
- 3000 series managed switches	292
- 4000 series managed Gigabit switches	294
- Lean Managed Switches	296
- Smart Managed Switches	300
- PROFINET realtime switches	302
- Gigabit Modular Switches	307
- Interface modules	308
<hr/>	
Network infrastructure for IEC 61850	310
<hr/>	
Security routers and firewalls	
Security routers for DIN rails	317
Firewall/router for office-based/mobile use	320
<hr/>	
Software for Ethernet networks	322
<hr/>	
Services for Industrial Ethernet	324
<hr/>	
Gateways and proxies	326
<hr/>	
Network installation	328
<hr/>	
Wireless Ethernet	494

Product overview

Unmanaged switches



Standard Switches with basic function
Page 276

Managed switches



Managed Switches feature flexible, scalable performance
Page 292



Lean Managed Switches up to 8 ports (RJ45/FO)
Page 296



Smart Managed Compact Switches with up to 16 ports (RJ45/FO)
Page 300

Managed switches



PROFINET Realtime Switch (RJ45/SC-RJ)
Page 302



Switches for high-availability EtherNet/IP™ networks
Page 304



Gigabit Modular Switches with up to 28 ports (RJ45/FO)
Page 307

Accessories



Plug-in I/O module and replaceable configuration connector
Page 308

Hubs



Ethernet hubs with 8/16 RJ45 ports
Page 289

Power over Ethernet



Power over Ethernet module with 2 PoE ports
Page 291

Network infrastructure for IEC 61850



Unmanaged Switch
Page 310



Managed Switch for the DIN rail
Page 311



Managed Switch for 19" rack mounting
Page 312



Redundancy modules
Page 314

Secure networks



Firewall/router and Layer 3 switches
Page 306



Security routers for DIN rails
Page 316



Security routers without DIN rail
Page 320



VPN routers for mobile communication
Page 397

Software



Network management software
Page 453

Services



Service packages for Industrial Ethernet
Page 324

Wireless Ethernet



Industrial WLAN
Page 494



Industrial Bluetooth
Page 496

Wireless accessories



Antennas, adapter cables, and surge protection
Page 514

Gateways/proxies



Proxies as a link between PROFINET networks and other fieldbus systems
Page 326

Media converters



Media converters for conversion to fiber optics
Page 380

COM server



Device servers for converting serial interfaces
Page 380

ISOLATOR



Isolator for electrical isolation
Page 386

Accessories



Patch fields and cables
Page 388

Unmanaged Switches

Standard switches with basic functions

- FL SWITCH SFNB...** unmanaged switches are optimized for basic and entry level applications where low installed costs with full industrialization are required.
- 5 to 8 ports in a narrow, metal housing
 - Optional SC and ST fiber optic ports
 - For longer distances, multi-mode and single-mode fiber connections are available
 - RJ45 ports provide 10/100 Mbps speeds; fiber optic ports operate at 100 Mbps
 - Auto Negotiation and autocross recognition provide easy installation and setup
 - LED indicators provide local diagnostics
 - Cable locking security options

Ethernet



5 RJ45 ports



Technical data	
Ethernet interface	
Number of ports	5 (RJ45 ports)
Transmission speed	10/100 Mbps
Fiber optic interface	
Number of ports	-
Transmission speed	-
Connection method	-
Wavelength	-
Transmission length	-
Function	
Basic functions	Unmanaged switch / auto negotiation, complies with IEEE 802.3, store-and-forward switching mode
Status and diagnostics indicators	LEDs: U _S , link and activity per port
Power supply	
Supply voltage	24 V DC
Residual ripple	3.6 V _{PP}
Supply voltage range	12 V DC ... 48 V DC
Typical current consumption	185 mA (at U _S = 24 V DC)
General data	
Dimensions	W / H / D 28 mm / 110 mm / 70 mm
Degree of protection	IP20
Ambient temperature (operation)	-10 °C ... 60 °C
Permissible humidity (operation)	5 % ... 95 % (non-condensing)
Noise emission	EN 61000-6-4
Noise immunity	EN 61000-6-2

Ordering data			
Description	Type	Order No.	Pcs. / Pkt.
Ethernet switch - 5 RJ45 ports - 8 RJ45 ports - 4 RJ45 ports, 1 SC FO port - 4 RJ45 ports, 1 ST FO port	FL SWITCH SFNB 5TX	2891001	1

Ethernet



8 RJ45 ports

Ethernet



4 RJ45 ports and 1 fiber optic port (multi mode)

Ethernet



4 RJ45 ports and 1 fiber optic port (single mode)



Ex:



Ex:



Ex:

Technical data

8 (RJ45 ports)
10/100 Mbps

-
-
-
-

Unmanaged switch / auto negotiation, complies with IEEE 802.3, store-and-forward switching mode

LEDs: U_S, link and activity per port

24 V DC
3.6 V_{PP}
9 V DC ... 32 V DC
140 mA (at U_S = 24 V DC)

50 mm / 110 mm / 70 mm
IP20
-10 °C ... 60 °C
5 % ... 95 % (non-condensing)
EN 61000-6-4
EN 61000-6-2:2005

Ordering data

Type	Order No.	Pcs. / Pkt.
FL SWITCH SFNB 8TX	2891002	1

Technical data

FL SWITCH SFNB 4TX/FX FL SWITCH SFNB 4TX/FX ST

4 (RJ45 ports)
10/100 Mbps

1 (SC multi mode)	1 (ST multi mode)
100 Mbps (full duplex)	
SC	ST
1300 nm	
12.1 km (fiberglass with F-G 62.5/125 0.7 dB/km F1000)	

Unmanaged switch / auto negotiation, complies with IEEE 802.3, store-and-forward switching mode

LEDs: U_S, link and activity per port

24 V DC	24 V DC
3.6 V _{PP}	3.6 V _{PP}
12 V DC ... 48 V DC	12 V DC ... 48 V DC
185 mA (at U _S = 24 V DC)	175 mA (at U _S = 24 V DC)

28 mm / 110 mm / 70 mm	28 mm / 110 mm / 70 mm
IP20	
0 °C ... 60 °C	-10 °C ... 60 °C
5 % ... 95 % (non-condensing)	
EN 61000-6-4	
EN 61000-6-2	

Ordering data

Type	Order No.	Pcs. / Pkt.
FL SWITCH SFNB 4TX/FX	2891027	1
FL SWITCH SFNB 4TX/FX ST	2891028	1

Technical data

4 (RJ45 ports)
10/100 Mbps

1 (SC single mode)
100 Mbps (full duplex)
SC
1300 nm
25 km (fiberglass with F-G 9/125 0.5 dB/km)

Unmanaged switch / auto negotiation, complies with IEEE 802.3, store-and-forward switching mode

LEDs: U_S, link and activity per port

24 V DC
3.6 V_{PP}
12 V DC ... 48 V DC
175 mA (at U_S = 24 V DC)

28 mm / 110 mm / 70 mm
IP20
-10 °C ... 60 °C
5 % ... 95 % (non-condensing)
EN 61000-6-4
EN 61000-6-2

Ordering data

Type	Order No.	Pcs. / Pkt.
FL SWITCH SFNB 4TX/FX SM20	2891029	1

Standard switches with up to 8 ports

FL SWITCH SFN... unmanaged switches have a wide range of configurations and features for general purpose applications.

- 5 to 8 ports in a narrow, metal housing
- Optional SC and ST fiber optic ports
- Quality of Service (QoS) prioritized messages
- RJ45 ports provide 10/100 Mbps speeds; fiber optic ports operate at 100 Mbps
- Auto Negotiation and autocross recognition provide easy installation and setup
- LED indicators provide local diagnostics
- Switch-mounted cable locking and port blocking options

Ethernet



new

5/8 RJ45 ports
for PROFINET

Ethernet interface	
Number of ports	
Transmission speed	
Fiber optic interface	
Number of ports	
Transmission speed	
Wavelength	
Transmission length	
Function	
Basic functions	
Status and diagnostics indicators	
Power supply	
Supply voltage	
Residual ripple	
Supply voltage range	
Typical current consumption	
General data	
Dimensions	W / H / D
Degree of protection	
Ambient temperature (operation)	
Permissible humidity (operation)	
Noise emission	
Noise immunity	

Technical data		
	FL SWITCH SFN 5TX-PN	FL SWITCH SFN 8TX-PN
Number of ports	5 (RJ45 ports)	8 (RJ45 ports)
Transmission speed	10/100 Mbps	
Number of ports	-	-
Transmission speed	-	-
Wavelength	-	-
Transmission length	-	-
Function		
Basic functions		
Unmanaged switch / auto negotiation, complies with IEEE 802.3, store-and-forward switching mode		
Status and diagnostics indicators		
	LEDs: U _S , link and activity per port	LEDs: U _{S1} , link and activity per port
Power supply		
Supply voltage	24 V DC	
Residual ripple	3.6 V _{pp}	
Supply voltage range	9 V DC ... 32 V DC	
Typical current consumption	typ. 90 mA (at U _S = 24 V DC)	typ. 140 mA (at U _S = 24 V DC)
General data		
Dimensions	30 mm / 130 mm / 100 mm	50 mm / 130 mm / 100 mm
Degree of protection	IP20	
Ambient temperature (operation)	0 °C ... 60 °C	
Permissible humidity (operation)	5 % ... 95 % (non-condensing)	
Noise emission	EN 61000-6-4	
Noise immunity	-	EN 61000-6-2:2005

Description	
Ethernet switch	
- 5 RJ45 ports	
- 8 RJ45 ports	
- 8 RJ45 ports, flow control disabled	
- 4 RJ45 ports, 1 SC FO port	
- 4 RJ45 ports, 1 ST FO port	
- 7 RJ45 ports, 1 SC FO port	
- 7 RJ45 ports, 1 ST FO port	
- 7 RJ45 ports, 1 SC FO port, flow control disabled	
- 6 RJ45 ports, 2 SC FO ports	
- 6 RJ45 ports, 2 ST FO ports	
- 6 RJ45 ports, 2 SC FO ports, flow control disabled	

Ordering data		
Type	Order No.	Pcs. / Pkt.
FL SWITCH SFN 5TX-PN	2891151	1
FL SWITCH SFN 8TX-PN	2891018	1

Layer-1 security elements

Accessories
FL PLUG GUARD...

Ethernet



5/8 RJ45 ports

Ethernet



4/7 RJ45 ports and 1 FO port

Ethernet



6 RJ45 ports and 2 FO ports



Ex:



Ex:



Ex:

Technical data	
FL SWITCH SFN 5TX	FL SWITCH SFN 8TX
5 (RJ45 ports)	8 (RJ45 ports)
10/100 Mbps	
-	-
-	-
-	-
Unmanaged switch / auto negotiation, complies with IEEE 802.3, store-and-forward switching mode	
LEDs: U _S , link and activity per port	LEDs: U _{S1} , link and activity per port
24 V DC	24 V DC
3.6 V _{PP}	3.6 V _{PP}
9 V DC ... 32 V DC	9 V DC ... 32 V DC
90 mA (at U _S = 24 V DC)	typ. 140 mA (at U _S = 24 V DC)
30 mm / 120 mm / 70 mm	50 mm / 120 mm / 70 mm
IP20	
0 °C ... 60 °C	
5 % ... 95 % (non-condensing)	
EN 61000-6-4	
EN 61000-6-2:2005	

Technical data	
FL SWITCH SFN 4TX/FX	FL SWITCH SFN 7TX/FX ST
4 (RJ45 ports)	7 (RJ45 ports)
10/100 Mbps	
1 (SC multi mode)	1 (ST multi mode)
100 Mbps (full duplex)	
1300 nm/1310 nm	
2000 m (fiberglass 50/125)	
2000 m (fiberglass 62.5/125)	
Unmanaged switch / auto negotiation, complies with IEEE 802.3, store-and-forward switching mode	
LEDs: U _S , link and activity per port	
24 V DC	24 V DC
3.6 V _{PP}	3.6 V _{PP}
9 V DC ... 32 V DC	9 V DC ... 32 V DC
typ. 140 mA (at U _S = 24 V DC)	typ. 190 mA (at U _S = 24 V DC)
30 mm / 120 mm / 70 mm	50 mm / 120 mm / 70 mm
IP20	
0 °C ... 60 °C	
5 % ... 95 % (non-condensing)	
EN 61000-6-4	
EN 61000-6-2:2005	

Technical data	
FL SWITCH SFN 6TX/2FX	FL SWITCH SFN 6TX/2FX ST
6 (RJ45 ports)	
10/100 Mbps	
2 (SC multi mode)	2 (ST multi mode)
100 Mbps (full duplex)	
1300 nm	
2000 m (fiberglass 50/125)	
2000 m (fiberglass 62.5/125)	
Unmanaged switch / auto negotiation, complies with IEEE 802.3, store-and-forward switching mode	
LEDs: U _S , link and activity per port	
24 V DC	24 V DC
3.6 V _{PP}	3.6 V _{PP}
9 V DC ... 32 V DC	9 V DC ... 32 V DC
typ. 230 mA (at U _S = 24 V DC)	
50 mm / 120 mm / 70 mm	
IP20	
0 °C ... 60 °C	
5 % ... 95 % (non-condensing)	
EN 61000-6-4	
EN 61000-6-2:2005	

Ordering data		
Type	Order No.	Pcs. / Pkt.
FL SWITCH SFN 5TX	2891152	1
FL SWITCH SFN 8TX	2891929	1
FL SWITCH SFN 8TX-NF	2891022	1

Ordering data		
Type	Order No.	Pcs. / Pkt.
FL SWITCH SFN 4TX/FX	2891851	1
FL SWITCH SFN 4TX/FX ST	2891453	1
FL SWITCH SFN 7TX/FX	2891097	1
FL SWITCH SFN 7TX/FX ST	2891110	1
FL SWITCH SFN 7TX/FX-NF	2891023	1

Ordering data		
Type	Order No.	Pcs. / Pkt.
FL SWITCH SFN 6TX/2FX	2891314	1
FL SWITCH SFN 6TX/2FX ST	2891411	1
FL SWITCH SFN 6TX/2FX-NF	2891024	1

Accessories
FL PLUG GUARD...

Accessories
FL PLUG GUARD...

Accessories
FL PLUG GUARD...

Standard switches with up to 16 ports

- FL SWITCH SFN(T)...** 16-port unmanaged switches provide high-density Ethernet connections for large or supervisory applications.
- 16 ports in a narrow, metal housing with redundant power supply
 - Optional SC fiber optic ports
 - Standard temperature (0 °C ... 60 °C) and wide temperature (-40 °C ... 75 °C) devices available
 - RJ45 ports provide 10/100 Mbps speeds; fiber optic ports operate at 100 Mbps
 - Auto Negotiation and autocross recognition provide easy installation and setup
 - LED indicators provide local diagnostics
 - Cable locking security options
 - DC and AC power supply options

Ethernet



5/8 RJ45 ports with AC supply



Ethernet interface	
Number of ports	
Transmission speed	
Fiber optic interface	
Number of ports	
Transmission speed	
Wavelength	
Transmission length	
Function	
Basic functions	
Status and diagnostics indicators	
Power supply	
Supply voltage	
Residual ripple	
Supply voltage range	
Typical current consumption	
General data	
Dimensions	W / H / D
Degree of protection	
Ambient temperature (operation)	
Permissible humidity (operation)	
Noise emission	
Noise immunity	

Technical data		
	FL SWITCH SFN 5TX-24VAC	FL SWITCH SFN 8TX-24VAC
Number of ports	5 (RJ45 ports)	8 (RJ45 ports)
Transmission speed	10/100 Mbps	
Number of ports	-	-
Transmission speed	-	-
Wavelength	-	-
Transmission length	-	-
Unmanaged switch / auto negotiation, complies with IEEE 802.3, store-and-forward switching mode		
LEDs: U _S , link and activity per port	LEDs: U _{S1} , link and activity per port	
Supply voltage	24 V AC/DC	
Residual ripple	3.6 V _{pp}	
Supply voltage range	20 V AC ... 28 V AC	
Typical current consumption	typ. 114 mA	189 mA
Dimensions	30 mm / 120 mm / 70 mm	50 mm / 120 mm / 70 mm
Degree of protection	IP20	
Ambient temperature (operation)	0 °C ... 60 °C	
Permissible humidity (operation)	5 % ... 95 % (non-condensing)	
Noise emission	EN 61000-6-4	
Noise immunity	EN 61000-6-2:2005	

Description	
Ethernet switch	
- 5 RJ45 ports	
- 8 RJ45 ports	
Ethernet switch	
- 16 RJ45 ports	
- 15 RJ45 ports, 1 FO port	
Ethernet switch, wide temperature	
- 16 RJ45 ports	
- 15 RJ45 ports, 1 FO port	
- 14 RJ45 ports, 2 FO ports	

Ordering data		
Type	Order No.	Pcs. / Pkt.
FL SWITCH SFN 5TX-24VAC	2891021	1
FL SWITCH SFN 8TX-24VAC	2891020	1

Ethernet



16 RJ45 ports

Ethernet



15 RJ45 ports and 1 FO port

Ethernet



14 RJ45 ports and 2 FO ports



Technical data	
FL SWITCH SFN 16TX	FL SWITCH SFNT 16TX
16 (RJ45 ports) 10/100 Mbps	
-	
-	
-	
Unmanaged switch / auto negotiation, complies with IEEE 802.3, store-and-forward switching mode, includes alarm contacts	
LEDs: U _{S1} , U _{S2} (redundant voltage supply), link and activity per port, voltage alarm	
24 V DC (redundant) 3.6 V _{PP} 12 V DC ... 48 V DC 350 mA (at U _S = 24 V DC)	
70 mm / 135 mm / 110 mm IP20	
0 °C ... 60 °C -40 °C ... 75 °C 5 % ... 95 % (non-condensing) EN 61000-6-4 EN 61000-6-2	

Technical data	
FL SWITCH SFN 15TX/FX	FL SWITCH SFNT 15TX/FX
15 (RJ45 ports) 10/100 Mbps	
1 (SC multi mode) 100 Mbps (full duplex) 1300 nm 12.1 km (fiberglass with F-G 62.5/125 0.7 dB/km F1000)	
Unmanaged switch / auto negotiation, complies with IEEE 802.3, store-and-forward switching mode, includes alarm contacts	
LEDs: U _{S1} , U _{S2} (redundant voltage supply), link and activity per port, voltage alarm	
24 V DC (redundant) 3.6 V _{PP} 12 V DC ... 48 V DC 350 mA (at U _S = 24 V DC)	
70 mm / 135 mm / 110 mm IP20	
0 °C ... 60 °C -40 °C ... 75 °C 5 % ... 95 % (non-condensing) EN 61000-6-4 EN 61000-6-2	

Technical data	
FL SWITCH SFN 14TX/2FX	FL SWITCH SFNT 14TX/2FX
14 (RJ45 ports) 10/100 Mbps	
2 (SC multi mode) 100 Mbps (full duplex) 1300 nm 12.1 km (fiberglass with F-G 62.5/125 0.7 dB/km F1000)	
Unmanaged switch / auto negotiation, complies with IEEE 802.3, store-and-forward switching mode, includes alarm contacts	
LEDs: U _{S1} , U _{S2} (redundant voltage supply), link and activity per port, voltage alarm	
24 V DC (redundant) 3.6 V _{PP} 12 V DC ... 48 V DC 350 mA (at U _S = 24 V DC)	
70 mm / 135 mm / 110 mm IP20	
0 °C ... 60 °C -40 °C ... 75 °C 5 % ... 95 % (non-condensing) EN 61000-6-4 EN 61000-6-2	

Ordering data		
Type	Order No.	Pcs. / Pkt.
FL SWITCH SFN 16TX	2891933	1
FL SWITCH SFNT 16TX	2891952	1

Ordering data		
Type	Order No.	Pcs. / Pkt.
FL SWITCH SFN 15TX/FX	2891934	1
FL SWITCH SFNT 15TX/FX	2891953	1

Ordering data		
Type	Order No.	Pcs. / Pkt.
FL SWITCH SFNT 14TX/2FX	2891954	1

FL SWITCH SFN... Gigabit unmanaged switches have a wide range of fiber and copper port configurations for high performance applications.

- 5/8 ports in a narrow, metal housing with redundant power supply
- All ports provide 1000 Mbps speeds
- LED indicators provide local diagnostics
- Relay contact
- **FL SWITCH SFN 6GT/2LX** provides up to 10 km transmission length with 2 single-mode fiber ports
- **FL SWITCH SFN 6GT/2LX-20** provides up to 20 km transmission length with 2 single-mode fiber ports

Ethernet



new

5/8 RJ45 ports

Ethernet interface	
Number of ports	
Transmission speed	
Fiber optic interface	
Number of ports	
Transmission speed	
Wavelength	
Transmission length	
Other connections	
-	
Function	
Basic functions	
Status and diagnostics indicators	
Power supply	
Supply voltage	
Residual ripple	
Supply voltage range	
Typical current consumption	
General data	
Dimensions	W / H / D
Degree of protection	
Ambient temperature (operation)	
Permissible humidity (operation)	
EMC note	
Noise emission	
Noise immunity	

Technical data	
FL SWITCH SFN 5GT	FL SWITCH SFN 8GT
5 (RJ45 ports)	8 (RJ45 ports)
10/100/1000 Mbps	
-	-
-	-
-	-
-	Plug-in/screw connection via COMBICON
Unmanaged switch / auto negotiation, complies with IEEE 802.3, store-and-forward switching mode	
LEDs: U _S , link and activity per port	LEDs: U _{S1} , U _{S2} (redundant voltage supply), link and activity per port
24 V DC	24 V DC (redundant)
	3.6 V _{PP}
10 V DC ... 60 V DC	9 V DC ... 32 V DC
typ. 200 mA (at U _S = 24 V DC)	typ. 430 mA (at U _S = 24 V DC)
28 mm / 110 mm / 70 mm	50 mm / 120 mm / 70 mm
	IP20
-10 °C ... 60 °C	-25 °C ... 75 °C
	5 % ... 95 % (non-condensing)
	EN 61000-6-4
	EN 61000-6-2:2005

Description
Ethernet switch
- 5 RJ45 ports
- 8 RJ45 ports
- 7 RJ45 ports, 1 SC FO port (multi mode)
- 6 RJ45 ports, 2 SC FO ports (multi mode)
- 6 RJ45 ports, 2 SC FO ports (single mode) with 10 km range
- 6 RJ45 ports, 2 SC FO ports (single mode) with 20 km range
Ethernet switch, wide temperature
- 5 RJ45 ports
Ethernet switch, wide temperature, conformal coating for harsh environments
- 5 RJ45 ports

Ordering data		
Type	Order No.	Pcs. / Pkt.
FL SWITCH SFN 5GT	2891444	1
FL SWITCH SFN 8GT	2891673	1

Layer-1 security elements

Accessories

new

Ethernet



7 / 6 RJ45 ports and
1 / 2 fiber optic ports (multi mode)

Ethernet



6 RJ45 ports and
2 fiber optic ports (single mode)

Ethernet



5 RJ45 ports, extended temperature range
(-40 °C ... 75 °C)



Technical data	
FL SWITCH SFN 7GT/SX	FL SWITCH SFN 6GT/2SX
7 (RJ45 ports)	6 (RJ45 ports)
10/100/1000 Mbps	
1 (SC multi mode)	2 (SC multi mode)
1000 Mbps (full duplex)	
850 nm	
220 m (fiberglass 62.5/125)	
Plug-in/screw connection via COMBICON	
Unmanaged switch / auto negotiation, complies with IEEE 802.3, store-and-forward switching mode	
LEDs: U _{S1} , U _{S2} (redundant voltage supply), link and activity per port	
24 V DC (redundant)	
3.6 V _{PP}	
9 V DC ... 32 V DC	
typ. 320 mA (at U _S = 24 V DC)	typ. 350 mA (at U _S = 24 V DC)
50 mm / 120 mm / 70 mm	
IP20	
-25 °C ... 75 °C	
5 % ... 95 % (non-condensing)	
Class A product, see page 527	
EN 61000-6-4	
EN 61000-6-2:2005	

Technical data	
FL SWITCH SFN 6GT/2LX	FL SWITCH SFN 6GT/2LX-20
6 (RJ45 ports)	
10/100/1000 Mbps	
2 (SC single mode)	
1000 Mbps (full duplex)	
1310 nm	
10000 m (fiberglass 9/125)	20000 m (fiberglass 9/125)
Plug-in/screw connection via COMBICON	
Unmanaged switch / auto negotiation, complies with IEEE 802.3, store-and-forward switching mode	
LEDs: U _{S1} , U _{S2} (redundant voltage supply), link and activity per port	
24 V DC (redundant)	
3.6 V _{PP}	
9 V DC ... 32 V DC	
typ. 360 mA (at U _S = 24 V DC)	
50 mm / 120 mm / 70 mm	
IP20	
-25 °C ... 75 °C	
5 % ... 95 % (non-condensing)	
EN 61000-6-4	
EN 61000-6-2:2005	

Technical data	
FL SWITCH SFNT 5GT	FL SWITCH SFNT 5GT-C
5 (RJ45 ports)	
10/100/1000 Mbps	
-	
-	
-	
-	
Unmanaged switch / auto negotiation, complies with IEEE 802.3, store-and-forward switching mode, includes QoS and alarm contact	
LEDs: U _{S1} , U _{S2} (redundant voltage supply), link and activity per port, alarm (power and link down)	
24 V DC (redundant)	
3.6 V _{PP}	
10 V DC ... 60 V DC	
typ. 223 mA (at U _S = 24 V DC)	
50 mm / 130 mm / 100 mm	
IP20	
-40 °C ... 75 °C	
5 % ... 95 % (non-condensing)	
EN 61000-6-4	
-	

Ordering data		
Type	Order No.	Pcs. / Pkt.
FL SWITCH SFN 7GT/SX	2891518	1
FL SWITCH SFN 6GT/2SX	2891398	1

Ordering data		
Type	Order No.	Pcs. / Pkt.
FL SWITCH SFN 6GT/2LX	2891987	1
FL SWITCH SFN 6GT/2LX-20	2891563	1

Ordering data		
Type	Order No.	Pcs. / Pkt.
FL SWITCH SFNT 5GT	2891390	1
FL SWITCH SFNT 5GT-C	2891391	1

Accessories
FL PLUG GUARD...

Accessories
FL PLUG GUARD...

Accessories
FL PLUG GUARD...

Unmanaged Switches

Standard switches with wide temperature range

- FL SWITCH SFNT...** unmanaged switches are optimized for use in extreme environments and marine applications.
- 5 to 8 ports in a narrow, metal housing with redundant power supply
 - Optional SC and ST fiber optic ports
 - RJ45 ports provide 10/100 Mbps speeds; fiber optic ports operate at 100 Mbps
 - Extended temperature range (–40°C ... +75°C) for harsh environments
 - Auto Negotiation and autocross recognition provide easy installation and setup
 - Quality of Service (QoS) prioritized messages
 - LED indicators provide local diagnostics
 - Alarm contact provides power and link status diagnostics
 - Switch-mounted cable locking and port blocking options

Ethernet



5/8 RJ45 ports

Ex:

Ethernet interface	
Number of ports	
Transmission speed	
Connection method	
Fiber optic interface	
Number of ports	
Transmission speed	
Wavelength	
Transmission length	
Function	
Basic functions	
Status and diagnostics indicators	
Power supply	
Supply voltage	
Residual ripple	
Supply voltage range	
Typical current consumption	
General data	
Dimensions	W / H / D
Degree of protection	
Ambient temperature (operation)	
Permissible humidity (operation)	
EMC note	
Noise emission	
Noise immunity	

Technical data	
FL SWITCH SFNT 5TX	FL SWITCH SFNT 8TX
5 (RJ45 ports)	8 (RJ45 ports)
	10/100 Mbps RJ45
	-
	-
	-
	-
Unmanaged switch / auto negotiation, complies with IEEE 802.3, store-and-forward switching mode, includes QoS and alarm contact	
LEDs: U _{S1} , U _{S2} (redundant voltage supply), link and activity per port, alarm (power and link down)	
	24 V DC (redundant)
	3.6 V _{PP}
	9 V DC ... 32 V DC
125 mA (at U _S = 24 V DC)	155 mA (at U _S = 24 V DC)
General data	
Dimensions	30 mm / 130 mm / 100 mm
Degree of protection	IP20
Ambient temperature (operation)	-40 °C ... 75 °C
Permissible humidity (operation)	5 % ... 95 % (non-condensing)
EMC note	
Noise emission	EN 61000-6-4
Noise immunity	EN 61000-6-2

Description
Ethernet switch, wide temperature
- 5 RJ45 ports
- 8 RJ45 ports
- 4 RJ45 ports, 1 SC FO port
- 7 RJ45 ports, 1 SC FO port
- 7 RJ45 ports, 1 ST FO port
- 6 RJ45 ports, 2 SC FO ports
- 6 RJ45 ports, 2 ST FO ports
Ethernet switch, wide temperature, conformal coating for harsh environments
- 5 RJ45 ports
- 8 RJ45 ports
- 4 RJ45 ports, 1 SC FO port
- 7 RJ45 ports, 1 SC FO port
- 7 RJ45 ports, 1 ST FO port
- 6 RJ45 ports, 2 SC FO ports
- 6 RJ45 ports, 2 ST FO ports

Ordering data		
Type	Order No.	Pcs. / Pkt.
FL SWITCH SFNT 5TX	2891003	1
FL SWITCH SFNT 8TX	2891005	1
FL SWITCH SFNT 5TX-C	2891043	1
FL SWITCH SFNT 8TX-C	2891045	1

Mounting plate, for 5- and 8-port SFNT switches
--

Accessories		
FL PA SFNT 5-8	2891012	1

Ethernet



4 RJ45 ports and 1 FO port

Ethernet



7 RJ45 ports and 1 FO port

Ethernet



6 RJ45 ports and 2 FO ports

Ex:

Ex:

Ex:

Technical data
FL SWITCH SFNT 4TX/FX
4 (RJ45 ports) 10/100 Mbps RJ45
1 (SC multi mode) 100 Mbps (full duplex) 1300 nm 12.1 km (fiberglass with F-G 62.5/125 0.7 dB/km F1000)
Unmanaged switch / auto negotiation, complies with IEEE 802.3, store-and-forward switching mode, includes QoS and alarm contact
LEDs: U _{S1} , U _{S2} (redundant voltage supply), link and activity per port, alarm (power and link down)
24 V DC (redundant) 3.6 V _{PP} 9 V DC ... 32 V DC 180 mA (at U _S = 24 V DC)
30 mm / 130 mm / 100 mm IP20 -40 °C ... 75 °C 5 % ... 95 % (non-condensing)
EN 61000-6-4 EN 61000-6-2

Technical data
FL SWITCH SFNT 7TX/FX
7 (RJ45 ports) 10/100 Mbps RJ45
1 (SC multi mode) 100 Mbps (full duplex) 1300 nm 12.1 km (fiberglass with F-G 62.5/125 0.7 dB/km F1000)
1 (ST multi mode) 100 Mbps (full duplex)
Unmanaged switch / auto negotiation, complies with IEEE 802.3, store-and-forward switching mode, includes QoS and alarm contact
LEDs: U _{S1} , U _{S2} (redundant voltage supply), link and activity per port, alarm (power and link down)
24 V DC (redundant) 3.6 V _{PP} 9 V DC ... 32 V DC 180 mA (at U _S = 24 V DC)
50 mm / 130 mm / 100 mm IP20 -40 °C ... 75 °C 5 % ... 95 % (non-condensing)
EN 61000-6-4 EN 61000-6-2

Technical data
FL SWITCH SFNT 6TX/2FX
6 (RJ45 ports) 10/100 Mbps RJ45
2 (SC multi mode) 100 Mbps (full duplex) 1300 nm 12.1 km (fiberglass with F-G 62.5/125 0.7 dB/km F1000)
2 (ST multi mode) 100 Mbps (full duplex)
Unmanaged switch / auto negotiation, complies with IEEE 802.3, store-and-forward switching mode, includes QoS and alarm contact
LEDs: U _{S1} , U _{S2} (redundant voltage supply), link and activity per port, alarm (power and link down)
24 V DC (redundant) 3.6 V _{PP} 9 V DC ... 32 V DC 250 mA (at U _S = 24 V DC)
50 mm / 130 mm / 100 mm IP20 -40 °C ... 75 °C 5 % ... 95 % (non-condensing) Class A product, see page 527
EN 61000-6-4 EN 61000-6-2

Ordering data		
Type	Order No.	Pcs. / Pkt.
FL SWITCH SFNT 4TX/FX	2891004	1
FL SWITCH SFNT 4TX/FX-C	2891044	1

Ordering data		
Type	Order No.	Pcs. / Pkt.
FL SWITCH SFNT 7TX/FX	2891006	1
FL SWITCH SFNT 7TX/FX ST	2891007	1
FL SWITCH SFNT 7TX/FX-C	2891046	1
FL SWITCH SFNT 7TX/FX ST-C	2891047	1

Ordering data		
Type	Order No.	Pcs. / Pkt.
FL SWITCH SFNT 6TX/2FX	2891025	1
FL SWITCH SFNT 6TX/2FX ST	2891026	1
FL SWITCH SFNT 6TX/2FX-C	2891048	1
FL SWITCH SFNT 6TX/2FX ST-C	2891049	1

Accessories		
FL PA SFNT 5-8	2891012	1

Accessories		
FL PA SFNT 5-8	2891012	1

Accessories		
FL PA SFNT 5-8	2891012	1

Standard SF switch

FL SWITCH SF... unmanaged switches have a wide variety of port configurations in a low-profile, metal housing for general-purpose applications.

- Up to 16 ports in a low-profile, metal housing with redundant power supply
- Optional SC and ST fiber optic ports
- RJ45 ports provide 10/100 Mbps speeds; fiber optic ports operate at 100 Mbps
- Auto Negotiation and autocross recognition provide easy installation and setup
- LED indicators provide local diagnostics
- Relay contact provides power status alarming
- Cable locking security options

Ethernet



8/16 RJ45 ports



Ethernet interface	
Number of ports	
Transmission speed	
Fiber optic interface	
Number of ports	
Transmission speed	
Wavelength	
Transmission length	
Other connections	
Potential-free signaling contact	
Function	
Basic functions	
Status and diagnostics indicators	
Power supply	
Supply voltage	
Residual ripple	
Supply voltage range	
Typical current consumption	
General data	
Dimensions	W / H / D
Degree of protection	
Ambient temperature (operation)	
Permissible humidity (operation)	
EMC note	
Noise emission	
Noise immunity	

Technical data	
FL SWITCH SF 8TX	FL SWITCH SF 16TX
8 (RJ45 ports)	16 (RJ45 ports)
10/100 Mbps	
	-
	-
	-
	-
Plug-in/screw connection via COMBICON	
Unmanaged switch / auto negotiation, complies with IEEE 802.3, store-and-forward switching mode	
LEDs: U _{S1} , U _{S2} (redundant voltage supply), link and activity per port	
24 V DC (redundant)	
3.6 V _{pp}	
18.5 V DC ... 30.2 V DC	
typ. 200 mA (at U _S = 24 V DC)	typ. 300 mA (at U _S = 24 V DC)
IP20	
0 °C ... 55 °C	
5 % ... 95 % (non-condensing)	
Class A product, see page 527	
EN 61000-6-4	
EN 61000-6-2:2005	

Description
Ethernet switch
- 8 RJ45 ports
- 16 RJ45 ports
- 7 RJ45 ports, 1 SC FO port
- 7 RJ45 ports, 1 ST FO port
- 15 RJ45 ports, 1 SC FO port
- 6 RJ45 ports, 2 SC FO ports
- 6 RJ45 ports, 2 ST FO ports
- 14 RJ45 ports, 2 SC FO ports
- 4 RJ45 ports, 3 ST FO ports

Ordering data		
Type	Order No.	Pcs. / Pkt.
FL SWITCH SF 8TX	2832771	1
FL SWITCH SF 16TX	2832849	1

Ethernet



7/15 RJ45 ports and 1 FO port

Ethernet



6/14 RJ45 ports and 2 FO ports

Ethernet



4 RJ45 ports and 3 FO ports



Technical data	
FL SWITCH SF 7TX/FX	FL SWITCH SF 15TX/FX
7 (RJ45 ports)	15 (RJ45 ports)
10/100 Mbps	
1 (SC multi mode)	
100 Mbps (full duplex)	
1300 nm	
6400 m (fiberglass with F-G 50/125 0.7 dB/km F1200)	
Plug-in/screw connection via COMBICON	
Unmanaged switch / auto negotiation, complies with IEEE 802.3, store-and-forward switching mode	
LEDs: U _{S1} , U _{S2} (redundant voltage supply), link and activity per port	
24 V DC (redundant)	
3.6 V _{PP}	
18.5 V DC ... 30.2 V DC	
typ. 220 mA (at U _S = 24 V DC)	typ. 330 mA (at U _S = 24 V DC)
135 mm / 115.3 mm / 30 mm	205 mm / 115.3 mm / 30 mm
IP20	
0 °C ... 55 °C	
5 % ... 95 % (non-condensing)	
EN 61000-6-4	
EN 61000-6-2:2005	

Technical data	
FL SWITCH SF 6TX/2FX	FL SWITCH SF 14TX/2FX
6 (RJ45 ports)	14 (RJ45 ports)
10/100 Mbps	
2 (SC multi mode)	
100 Mbps (full duplex)	
1300 nm	
6400 m (fiberglass with F-G 50/125 0.7 dB/km F1200)	
Plug-in/screw connection via COMBICON	
Unmanaged switch / auto negotiation, complies with IEEE 802.3, store-and-forward switching mode	
LEDs: U _{S1} , U _{S2} (redundant voltage supply), link and activity per port	
24 V DC (redundant)	
3.6 V _{PP}	
18.5 V DC ... 30.2 V DC	
typ. 240 mA (at U _S = 24 V DC)	typ. 360 mA (at U _S = 24 V DC)
135 mm / 115.3 mm / 30 mm	205 mm / 115.3 mm / 30 mm
IP20	
0 °C ... 55 °C	
5 % ... 95 % (non-condensing)	
EN 61000-6-4	
EN 61000-6-2:2005	

Technical data	
4 (RJ45 ports)	
10/100 Mbps	
3 (ST multi mode)	
100 Mbps (full duplex)	
1300 nm	
6400 m (fiberglass with F-G 50/125 0.7 dB/km F1200)	
Plug-in/screw connection via COMBICON	
Unmanaged switch / auto negotiation, complies with IEEE 802.3, store-and-forward switching mode	
LEDs: U _{S1} , U _{S2} (redundant voltage supply), link and activity per port	
24 V DC (redundant)	
3.6 V _{PP}	
18.5 V DC ... 30.2 V DC	
typ. 240 mA (at U _S = 24 V DC)	
135 mm / 115.3 mm / 30 mm	
IP20	
0 °C ... 55 °C	
5 % ... 95 % (non-condensing)	
EN 61000-6-4	
EN 61000-6-2:2005	

Ordering data		
Type	Order No.	Pcs. / Pkt.
FL SWITCH SF 7TX/FX	2832726	1
FL SWITCH SF 7TX/FX ST	2832577	1
FL SWITCH SF 15TX/FX	2832661	1

Ordering data		
Type	Order No.	Pcs. / Pkt.
FL SWITCH SF 6TX/2FX	2832933	1
FL SWITCH SF 6TX/2FX ST	2832674	1
FL SWITCH SF 14TX/2FX	2832593	1

Ordering data		
Type	Order No.	Pcs. / Pkt.
FL SWITCH SF 4TX/3FX ST	2832603	1

Unmanaged Switches

Unmanaged Switches

FL SWITCH 1824... and **...1924** rack mount switches provide 24 twisted pair ports (RJ45) of 10/100 or 10/100/1000 Mbps and are optimized for large scale or 19" rack mount preferred applications.

Features:

- Fully industrial switches with high IEC 61000-4 noise immunity and 0 - 60°C operation
- Wide input AC voltage range for flexible use - AC powered 100-240 V AC

Ethernet



24 RJ45 ports
10/100 Mbps

Ethernet



24 RJ45 ports
10/100/1000 Mbps



	Technical data			Technical data		
Ethernet interface						
Number of ports	24 (RJ45 ports)			24 (RJ45 ports)		
Transmission speed	10/100 Mbps			10/100/1000 Mbps (full or half duplex)		
Connection method	RJ45			RJ45		
Function						
Basic functions	Unmanaged switch / auto negotiation, complies with IEEE 802.3, store-and-forward switching mode			Unmanaged switch / auto negotiation, complies with IEEE 802.3, store-and-forward switching mode		
Status and diagnostics indicators	LEDs: U _S , link and activity per port			LEDs: U _S , link and activity per port		
Power supply						
Supply voltage	120 V AC 220 V AC			120 V AC 220 V AC		
Supply voltage range	100 V AC ... 240 V AC (50/60 Hz)			100 V AC ... 240 V AC (50/60 Hz)		
Typical current consumption	270 mA (100 V AC)			312 mA (100 V AC)		
General data						
Dimensions	W / H / D	440 mm / 44 mm / 173 mm		482 mm / 44 mm / 210 mm		
Degree of protection	IP20			IP20		
Ambient temperature (operation)	0 °C ... 60 °C			0 °C ... 60 °C		
Permissible humidity (operation)	5 % ... 95 % (non-condensing)			5 % ... 95 % (non-condensing)		
EMC note				Class A product, see page 527		
Noise emission	EN 61000-6-4			EN 61000-6-4		
Noise immunity	EN 61000-6-2:2005			EN 61000-6-2:2005		
	Ordering data			Ordering data		
Description	Type	Order No.	Pcs. / Pkt.	Type	Order No.	Pcs. / Pkt.
Ethernet switch	FL SWITCH 1824	2891041	1	FL SWITCH 1924	2891057	1

Hubs

The **FL HUB 8/16TX ZF** is particularly flexible for use in applications where hubs are required. It is ideal for special automation protocols, such as Powerlink or FL Net.

The Ethernet T-coupler allows easy system conversion from fieldbus to industrial Ethernet. Thanks to the number of ports, it is particularly suitable for the distributed integration of field devices in a POF line or ring structure.

Ethernet



Hub with RJ45 ports



Ethernet



Ethernet fiber optics T-coupler for polymer and PCF fibers



Technical data	
FL HUB 8TX-ZF	FL HUB 16TX-ZF
Ethernet interface	
Number of ports	8 (RJ45 ports) / 16 (RJ45 ports)
Transmission speed	10/100 Mbps
Fiber optic interface	
Number of ports	-
Transmission length	-
Function	
Basic functions	Hub/repeater, compliance with IEEE 802.3
Status and diagnostics indicators	LEDs: UL (communications voltage), COL (collision) link and receive LED per port
Power supply	
Supply voltage	24 V DC
Residual ripple	3.6 V _{PP}
Supply voltage range	18.5 V DC ... 30.5 V DC
Typical current consumption	typ. 144 mA (at U _S = 24 V DC)
General data	
Dimensions	45 mm / 99 mm / 112 mm / 90 mm / 99 mm / 112 mm
Degree of protection	IP20
Ambient temperature (operation)	0 °C ... 60 °C / 0 °C ... 55 °C
Permissible humidity (operation)	30 % ... 95 % (non-condensing)
EMC note	Class A product, see page 527



Technical data	
Ethernet interface	
Number of ports	2 (RJ45 ports) / 2 (SCRJ)
Transmission speed	10/100 Mbps
Fiber optic interface	
Number of ports	2 (SCRJ)
Transmission length	Up to 250 m (depending on the fiber used)
Function	
Basic functions	Store-and-forward media converter standard-compliant IEEE 802.3 2, priority classes according to IEEE 802.1 P, TCP/IP protocol, BootP-compatible, port mirroring, integrated web server function, multicast filtering, IGMP snooping, VLAN, Rapid Spanning Tree (RSTP)
Status and diagnostics indicators	2 status LEDs per Ethernet: activity and duplex mode, supply voltage U _{S1} and U _{S2} (redundant supply voltage) as well as LED BAR GRAPH for FO ports for displaying the system reserve for each optical interface.
Power supply	
Supply voltage	24 V DC
Residual ripple	3.6 V _{PP}
Supply voltage range	18.5 V DC ... 30.5 V DC
Typical current consumption	400 mA (at U _S = 24 V DC)
General data	
Dimensions	45 mm / 99 mm / 123 mm
Degree of protection	IP20
Ambient temperature (operation)	-20 °C ... 55 °C
Permissible humidity (operation)	10 % ... 95 % (non-condensing)
EMC note	Class A product, see page 527

Ordering data		
Type	Order No.	Pcs. / Pkt.
FL HUB 8TX-ZF	2832551	1
FL HUB 16TX-ZF	2832564	1
FO T coupler, for converting 10/100BASE-T to polymer or PCF fiber, (660 nm), SC-RJ connection		

Ordering data		
Type	Order No.	Pcs. / Pkt.
FL MC ETH/FO 660 T	2313164	1

Unmanaged Switches

IP67 switches and Power over Ethernet switches

The **FL SWITCH 1605** was developed for use in harsh environments. Thanks to its degree of protection and compact design, it is ideal for use directly in the machine.

Power over Ethernet solutions

Power over Ethernet enables the common transmission of power and data.

FL PSE 2TX power source equipment

Thanks to the use of the Power over Ethernet standard IEEE 802.3af, the following terminal devices can be operated, for example:

- WLAN access points
- IP phones
- IP cameras

The **FL SWITCH 1001T-4POE** 5-port unmanaged switch provides four Power over Ethernet connections with 10/100 Mbps. Save time and money when installing industrial devices such as WLAN access points or security cameras.

Features:

- Flexible use of PoE devices thanks to powerful 30 W PoE ports (IEEE 802.3at)
- Extended temperature range (–40°C ... +75°C) for harsh environments
- Redundant supply with alarm contact for maximum network availability

The **FL SWITCH 1708 M12 POE** Gigabit Switch offers a unique combination of a high degree of protection, Gigabit transmission, and Power over Ethernet.

The IP67 switches can be installed in a distributed manner and enable connection of Power over Ethernet devices with gigabit transmission.

Features:

- Connection via gigabit M12 connector CAT6A
- Flexible use of PoE devices thanks to powerful 30 W PoE ports (IEEE 802.3at)
- –40°C ... +70°C ambient temperature
- Gigabit support
- Jumbo frames with up to 9720 bytes
- Robust metal housing
- IP67 protection
- Easy panel mounting

Ethernet



Standard switch, IP67 protection



Technical data

Ethernet interface	
Number of ports	5 (M12 socket)
Transmission speed	10/100 Mbps
Connection method	M12
Function	
Basic functions	Unmanaged switch/auto negotiation, complies with standard IEEE 802.3, store-and-forward switching mode, 2 priority classes according to IEEE802.1p, PTCP filter
Status and diagnostics indicators	LEDs: US (power supply), 2 LEDs per Ethernet port (Link and Activity)
Power supply	
Supply voltage	24 V DC (M12 connector)
Residual ripple	3,6 V _{pp}
Supply voltage range	18 V DC ... 32 V DC
Typical current consumption	40 mA (at U _s = 24 V DC)
General data	
Dimensions	W / H / D 30 mm / 200 mm / 41 mm
Degree of protection	IP65/IP66/IP67
Ambient temperature (operation)	–40 °C ... 70 °C
Permissible humidity (operation)	10 % ... 95 %
EMC note	

Ordering data

Description	Type	Order No.	Pcs. / Pkt.
Ethernet switch - 5 Ethernet ports in M12 format	FL SWITCH 1605 M12	2700200	1
Power-over-Ethernet module (PSE)			
Power-over-Ethernet switch			
Gigabit Power-over-Ethernet switch			

Ethernet



Power Source Equipment

Ethernet



Power-over-Ethernet switch

Ethernet



8 ports (M12 socket),
for wall mounting



Technical data
2 (PoE ports) 10/100 Mbps 8-pos. RJ45 socket
PSE/midspan, complies with IEEE 802.3af
LEDs: US, PoE detection per port
24 V DC (via COMBICON; max. conductor cross section 2.5 mm ²)
3.6 V _{pp} 18.5 V DC ... 30.5 V DC typ. 100 mA (During no load; approx. 1800 mA at 24 V at the input with maximum load and 25°C ambient temperature)
45 mm / 99 mm / 112 mm IP20 0 °C ... 55 °C 30 % ... 95 % (non-condensing) Class A product, see page 527

Technical data
5 (4x POE ports, 1x 10/100 port) 10/100 Mbps RJ45 socket
PSE, complies with IEEE 802.3at
LEDs: U _{S1} , U _{S2} (redundant voltage supply); alarm; LNK/ACT, POE, 100 Mbps per port
24 V DC
3.6 V _{pp} 18 V DC ... 57 V DC 2.7 A (at U _S = 48 V DC)
55 mm / 117 mm / 78 mm IP20 -40 °C ... 75 °C 5 % ... 95 % (non-condensing)

Technical data
8 (M12 socket) 10/100/1000 Mbps M12 connector, 8-pos.
Store-and-forward switch, 10/100/1000 Mbps, auto negotiation, complies with standard IEEE 802.3, 4 priority classes according to IEEE 802.1p, PoE according to IEEE 802.3at/802.3af, jumbo frames up to 9720 bytes
LEDs: US1, US2 (power supply), fail (alarm contact), 3 LEDs per Ethernet port (Link, Activity, and PoE Status), and PoE performance
24 V DC (M12 connector)
3.6 V _{pp} 18.7 V DC ... 30.5 V DC 300 mA (at U _S = 24 V DC)
176 mm / 112 mm / 100 mm IP65/IP66/IP67 -40 °C ... 70 °C (non-condensing) 10 % ... 95 %

Ordering data		
Type	Order No.	Pcs. / Pkt.
FL PSE 2TX	2891013	1

Ordering data		
Type	Order No.	Pcs. / Pkt.
FL SWITCH 1001T-4POE	2891064	1

Ordering data		
Type	Order No.	Pcs. / Pkt.
FL SWITCH 1708 M12 POE	2701883	1

Managed Switches

Managed Switches

The **FL SWITCH 3000** industrial managed switches provide scalable power for application flexibility and ease of use.

Features:

- Standard (-10 °C ... 60 °C) and wide temperature (-40 °C ... 75 °C) devices available
- Extended Ring Redundancy provides a 15 ms recovery time
- Extensive IEEE and security functions

Ethernet



5/8 RJ45 ports

Ethernet



16 RJ45 ports



	Technical data		Technical data			
	FL SWITCH 3005	FL SWITCH 3008T	FL SWITCH 3016	FL SWITCH 3016T		
Ethernet interface						
Number of ports	5 (RJ45 ports)	8 (RJ45 ports)	16 (RJ45 ports)			
Transmission speed	10/100 Mbps (with auto negotiation)		10/100 Mbps (with auto negotiation)			
Fiber optic interface						
Number of ports	-		-			
Transmission speed	-		-			
Wavelength	-		-			
Transmission length	-		-			
Function	Managed switch		Managed switch			
Basic functions	LEDs: U _{S1} , U _{S2} (redundant voltage supply), link and activity per port		LEDs: U _{S1} , U _{S2} (redundant voltage supply), link and activity per port			
Status and diagnostics indicators						
Power supply						
Supply voltage	24 V DC (redundant)		24 V DC (redundant)			
Residual ripple	3.6 V _{PP}		3.6 V _{PP}			
Supply voltage range	12 V DC ... 48 V DC		12 V DC ... 48 V DC			
Typical current consumption	200 mA (at U _S = 24 V DC)	210 mA (at U _S = 24 V DC)	312 mA (24 V DC)			
General data						
Dimensions	54.4 mm / 146.4 mm / 125 mm		66 mm / 173 mm / 140 mm			
Degree of protection	IP20		IP20			
Ambient temperature (operation)	-10 °C ... 60 °C	-40 °C ... 75 °C	-10 °C ... 60 °C	-40 °C ... 75 °C		
Permissible humidity (operation)	5 % ... 95 % (non-condensing)		5 % ... 95 % (non-condensing)			
Noise emission	EN 61000-6-4		EN 61000-6-4			
Noise immunity	EN 61000-6-2:2005		EN 61000-6-2:2005			
	Ordering data			Ordering data		
Description	Type	Order No.	Pcs. / Pkt.	Type	Order No.	Pcs. / Pkt.
Ethernet switch						
- 5 RJ45 ports	FL SWITCH 3005	2891030	1			
- 8 RJ45 ports	FL SWITCH 3008	2891031	1			
- 16 RJ45 ports				FL SWITCH 3016	2891058	1
Ethernet switch, wide temperature						
- 5 RJ45 ports	FL SWITCH 3005T	2891032	1			
- 8 RJ45 ports	FL SWITCH 3008T	2891035	1			
- 16 RJ45 ports				FL SWITCH 3016T	2891059	1
- 4 RJ45 ports, 1 SC FO port						
- 4 RJ45 ports, 1 ST FO port						
- 6 RJ45 ports, 2 SC FO ports						
- 6 RJ45 ports, 2 ST FO ports						

Ethernet



4 RJ45 ports and 1 fiber optic port (multi mode)

Ethernet



6 RJ45 ports and 2 fiber optic ports (multi mode)

6 RJ45 ports and 2 fiber optic ports (single mode)

Ex:

Technical data	
FL SWITCH 3004T-FX	FL SWITCH 3004T-FX ST
4 (RJ45 ports) 10/100 Mbps (with auto negotiation)	
1 (SC multi mode)	1 (ST multi mode)
100 Mbps (full duplex) 1300/1310 nm	
12.1 km (fiberglass with F-G 62.5/125 0.7 dB/km F1000)	
Managed switch	
LEDs: U _{S1} , U _{S2} (redundant voltage supply), link and activity per port	
24 V DC (redundant) 3.6 V _{PP} 12 V DC ... 48 V DC 230 mA (at U _S = 24 V DC)	
54.4 mm / 146.4 mm / 125 mm IP20 -40 °C ... 75 °C 5 % ... 95 % (non-condensing) EN 61000-6-4 EN 61000-6-2:2005	

Technical data	
FL SWITCH 3006T-2FX	FL SWITCH 3006T-2FX ST
6 (RJ45 ports) 10/100 Mbps (with auto negotiation)	
2 (SC multi mode)	2 (ST multi mode)
100 Mbps (full duplex) 1300/1310 nm	
12.1 km (fiberglass with F-G 62.5/125 0.7 dB/km F1000)	
Managed switch	
LEDs: U _{S1} , U _{S2} (redundant voltage supply), link and activity per port	
24 V DC (redundant) 3.6 V _{PP} 12 V DC ... 48 V DC 330 mA (at U _S = 24 V DC)	
54.4 mm / 146.4 mm / 125 mm IP20 -40 °C ... 75 °C 5 % ... 95 % (non-condensing) EN 61000-6-4 EN 61000-6-2:2005	

Technical data	
6 (RJ45 ports) 10/100 Mbps (with auto negotiation)	
2 (SC single mode)	
100 Mbps (full duplex) -	
40 km	
Managed switch	
LEDs: U _{S1} , U _{S2} (redundant voltage supply), link and activity per port	
24 V DC (redundant) 3.6 V _{PP} 12 V DC ... 48 V DC 330 mA (at U _S = 24 V DC)	
54.4 mm / 146.4 mm / 125 mm IP20 -40 °C ... 75 °C 5 % ... 95 % (non-condensing) EN 61000-6-4 EN 61000-6-2:2005	

Ordering data		
Type	Order No.	Pcs. / Pkt.
FL SWITCH 3004T-FX	2891033	1
FL SWITCH 3004T-FX ST	2891034	1

Ordering data		
Type	Order No.	Pcs. / Pkt.
FL SWITCH 3006T-2FX	2891036	1
FL SWITCH 3006T-2FX ST	2891037	1

Ordering data		
Type	Order No.	Pcs. / Pkt.
FL SWITCH 3006T-2FX SM	2891060	1

Managed Switches

The infrastructure managed switches **FL SWITCH 4000** provide gigabit trunk ports and can be flexibly scaled in their performance while maintaining ease of operation.

Features:

- 2 Gigabit ports for high performance data trunk lines
- Extended temperature range (–40°C ... +75°C) for harsh environments
- 15 ms recovery time with extended ring redundancy
- Extensive IEEE and security functions
- Flexible fiber interface options

Ethernet



8 RJ45 ports and 2 SFP ports

		Technical data		
Ethernet interface				
Number of ports		8 (RJ45 ports)		
Transmission speed		10/100 Mbps		
Gigabit Ethernet interface				
Number of ports		-		
Transmission speed		-		
Fiber optic interface				
Number of ports		2 (SFP ports)		
Transmission speed		1000 Mbps (full duplex)		
Wavelength		-		
Transmission length		up to 80 km (Depending on the fiber/SFP module used)		
Function				
Basic functions		Managed switch		
Status and diagnostics indicators		LEDs: U _{S1} , U _{S2} (redundant voltage supply), link and activity per port		
Power supply				
Supply voltage		24 V DC (redundant)		
Residual ripple		3,6 V _{PP}		
Supply voltage range		12 V DC ... 48 V DC		
Typical current consumption		278 mA (at U _S = 24 V DC)		
General data				
Dimensions	W / H / D	66 mm / 173 mm / 140 mm		
Degree of protection		IP20		
Ambient temperature (operation)		-40 °C ... 75 °C		
Permissible humidity (operation)		5 % ... 95 % (non-condensing)		
Noise emission		EN 61000-6-4		
Noise immunity		EN 61000-6-2:2005		
		Ordering data		
Description		Type	Order No.	Pcs. / Pkt.
Ethernet switch, wide temperature		FL SWITCH 4008T-2SFP	2891062	1

Ethernet



10 RJ45 ports and
4 fiber optic ports (single mode)

Ethernet



14 RJ45 ports and
2 fiber optic ports (multi mode)

Technical data

8 (RJ45 ports)
10/100 Mbps

2 (RJ45 ports)
10/100/1000 Mbps

4 (SC single mode)
100 Mbps (full duplex)

-

-

Managed switch
LEDs: U_{S1}, U_{S2} (redundant voltage supply), link and activity per port

24 V DC (redundant)
3.6 V_{PP}
12 V DC ... 48 V DC
488 mA (at U_S = 24 V DC)

66 mm / 173 mm / 140 mm
IP20
-40 °C ... 75 °C
5 % ... 95 % (non-condensing)
EN 61000-6-4
EN 61000-6-2:2005

Ordering data

Type	Order No.	Pcs. / Pkt.
FL SWITCH 4008T-2GT-4FX SM	2891061	1

Technical data

12 (RJ45 ports)
10/100 Mbps

2 (RJ45 ports)
10/100/1000 Mbps

2 (SC multi mode)
100 Mbps (full duplex)
1300/1310 nm
8 km (fiberglass with F-G 62.5/125 0.7 dB/km F1000)

Managed switch
LEDs: U_{S1}, U_{S2} (redundant voltage supply), link and activity per port

24 V DC (redundant)
3.6 V_{PP}
12 V DC ... 48 V DC
474 mA (24 V DC)

66 mm / 173 mm / 140 mm
IP20
-40 °C ... 75 °C
5 % ... 95 % (non-condensing)
EN 61000-6-4
EN 61000-6-2:2005

Ordering data

Type	Order No.	Pcs. / Pkt.
FL SWITCH 4012T-2GT-2FX	2891063	1

Maximum possible diagnostics in the minimum amount of space. The compact FO-compatible and managed Ethernet switches can be optimally incorporated in a wide range of applications thanks to their connection properties.

They have all the necessary standard functions for operating an Ethernet network that is both flexible and robust.

Features:

- Extended temperature range (-40 °C ... +70 °C)
- Comprehensive fiber optic versions
- Compact housing
- Configurable alarm contact

Ethernet

EtherNet/IP



5 RJ45 ports



Technical data

Ethernet interface	
Number of ports	5 (RJ45 ports)
Transmission speed	10/100 Mbps
Fiber optic interface	
Number of ports	-
Transmission speed	-
Wavelength	-
Transmission length	-
Other connections	
Serial (RS-232)	RS-232-C, 6-pos. MINI-DIN socket (PS/2)
Function	
Basic functions	Store-and-forward switch complies with IEEE 802.3, 2 priority classes according to IEEE 802.1p, TCP/IP protocol, BootP-compatible, port mirroring, integrated web server function, multicast filtering, IGMP snooping, VLAN, Rapid Spanning Tree (RSTP), DHCP server, PTCP filter
SNMP – Simple Network Management Protocol	Supported SNMP-MIBs: Enterprise, MIB II, Bridge
Redundancy	Rapid Spanning Tree 802.1w, Fast Ring Detection
Status and diagnostics indicators	LEDs: US1, US2 (power supply), fail (alarm contact), 2 LEDs per Ethernet port (link/activity and speed)
Power supply	
Supply voltage	24 V DC (redundant)
Residual ripple	3.6 V _{pp}
Supply voltage range	18.5 V DC ... 30.5 V DC
Typical current consumption	170 mA (at U _S = 24 V DC)
General data	
Dimensions	W / H / D 45 mm / 99 mm / 112 mm
Degree of protection	IP20
Ambient temperature (operation)	-40 °C ... 70 °C
Permissible humidity (operation)	30 % ... 95 % (non-condensing)
EMC note	Class A product, see page 527
Noise emission	EN 61000-6-3/-4
Noise immunity	EN 61000-6-2:2005

Ordering data

Description	Type	Order No.	Pcs. / Pkt.
Lean Managed Switch - 5 RJ45 ports - 8 RJ45 ports - 4 RJ45 ports, 1 SC FO port - 4 RJ45 ports, 1 ST FO port	FL SWITCH LM 5TX	2989527	1
Lean Managed Switch , preconfigured for Ethernet/IP - 5 RJ45 ports - 8 RJ45 ports - 4 RJ45 ports, 1 SC FO port - 4 RJ45 ports, 1 ST FO port Lean Managed Switch , for machine building	FL SWITCH LM 5TX-E	2989336	1
- 8 RJ45 ports			

Ethernet

EtherNet/IP



8 RJ45 ports

Ethernet

EtherNet/IP



4 RJ45 ports and 1 fiber optic port (multi mode)

Ethernet

EtherNet/IP



4 RJ45 ports and 1 fiber optic port (single mode)



Technical data

Technical data

Technical data

FL SWITCH LM 4TX/1FX	FL SWITCH LM 4TX/1FX ST
4 (RJ45 ports) 10/100 Mbps	
1 (SC multi mode) 100 Mbps (full duplex) 1300 nm	
11000 m (fiberglass with F-G 62.5/125 0.7 dB/km F1000) 6400 m (fiberglass with F-G 50/125 0.7 dB/km F1200) 3000 m (fiberglass with F-G 62.5/125 2.6 dB/km F600) 2800 m (fiberglass with F-G 50/125 1.6 dB/km F800)	
RS-232-C, 6-pos. MINI-DIN socket (PS/2)	
Store-and-forward switch complies with IEEE 802.3, 2 priority classes according to IEEE 802.1p, TCP/IP protocol, BootP-compatible, port mirroring, integrated web server function, multicast filtering, IGMP snooping, VLAN, Rapid Spanning Tree (RSTP), DHCP server, PTCP filter	
Supported SNMP-MIBs: Enterprise, MIB II, Bridge	
Rapid Spanning Tree 802.1w, Fast Ring Detection	
LEDs: US1, US2 (power supply), fail (alarm contact), 2 LEDs per Ethernet port (link/activity and speed)	
24 V DC (redundant) 3.6 V _{PP} 18.5 V DC ... 30.5 V DC 170 mA (at U _S = 24 V DC)	24 V DC (redundant) 3.6 V _{PP} 18.5 V DC ... 30.5 V DC 250 mA (at U _S = 24 V DC)
45 mm / 99 mm / 112 mm IP20 -40 °C ... 70 °C 30 % ... 95 % (non-condensing) Class A product, see page 527 EN 61000-6-3/-4 EN 61000-6-2:2005	45 mm / 99 mm / 112 mm IP20 -40 °C ... 70 °C 30 % ... 95 % (non-condensing) Class A product, see page 527 EN 61000-6-3/-4 EN 61000-6-2:2005

FL SWITCH LM 4TX/1FX SM	FL SWITCH LM 4TX/1FX SM ST
4 (RJ45 ports) 10/100 Mbps	
1 (SC single mode) 100 Mbps (full duplex) 1300 nm	
36000 m (fiberglass with F-G 9/125 0.36 dB/km) 32000 m (fiberglass with F-G 9/125 0.4 dB/km) 26000 m (fiberglass with F-G 9/125 0.5 dB/km) -	
RS-232-C, 6-pos. MINI-DIN socket (PS/2)	
Store-and-forward switch complies with IEEE 802.3, 2 priority classes according to IEEE 802.1p, TCP/IP protocol, BootP-compatible, port mirroring, integrated web server function, multicast filtering, IGMP snooping, VLAN, Rapid Spanning Tree (RSTP), DHCP server, PTCP filter	
Supported SNMP-MIBs: Enterprise, MIB II, Bridge	
Rapid Spanning Tree 802.1w, Fast Ring Detection	
LEDs: US1, US2 (power supply), fail (alarm contact), 2 LEDs per Ethernet port (link/activity and speed)	
24 V DC (redundant) 3.6 V _{PP} 18.5 V DC ... 30.5 V DC 250 mA (at U _S = 24 V DC)	24 V DC (redundant) 3.6 V _{PP} 18.5 V DC ... 30.5 V DC 250 mA (at U _S = 24 V DC)
45 mm / 99 mm / 112 mm IP20 -40 °C ... 70 °C 30 % ... 95 % (non-condensing) Class A product, see page 527 EN 61000-6-3/-4 EN 61000-6-2:2005	45 mm / 99 mm / 112 mm IP20 -40 °C ... 70 °C 30 % ... 95 % (non-condensing) Class A product, see page 527 EN 61000-6-3/-4 EN 61000-6-2:2005

Type	Order No.	Pcs. / Pkt.
FL SWITCH LM 8TX	2832632	1
FL SWITCH LM 8TX-E	2891466	1
FL SWITCH LM 8TX-B	2989446	1

Type	Order No.	Pcs. / Pkt.
FL SWITCH LM 4TX/1FX	2989624	1
FL SWITCH LM 4TX/1FX ST	2989721	1
FL SWITCH LM 4TX/1FX-E	2989433	1
FL SWITCH LM 4TX/1FX ST-E	2989530	1

Type	Order No.	Pcs. / Pkt.
FL SWITCH LM 4TX/1FX SM	2989828	1
FL SWITCH LM 4TX/1FX SM ST	2989925	1
FL SWITCH LM 4TX/1FX SM-E	2989637	1
FL SWITCH LM 4TX/1FX SM ST-E	2989734	1

Managed Switches

Lean Managed Switches

Features:

- RSTP with fast switch-over
- Port mirroring
- Configuration can be stored externally
- Web-based management, SNMP

Ethernet

EtherNet/IP



**4 RJ45 ports and
2 fiber optic ports (multi mode)**



Ethernet

EtherNet/IP



**4 RJ45 ports and
2 fiber optic ports (single mode)**



Technical data

FL SWITCH LM 4TX/2FX FL SWITCH LM 4TX/2FX ST

Ethernet interface	
Number of ports	4 (RJ45 ports)
Transmission speed	10/100 Mbps
Fiber optic interface	
Number of ports	2 (SC multi mode) 2 (ST multi mode)
Transmission speed	100 Mbps (full duplex)
Wavelength	1300 nm
Transmission length	11000 m (fiberglass with F-G 62.5/125 0.7 dB/km F1000) 6400 m (fiberglass with F-G 50/125 0.7 dB/km F1200) 3000 m (fiberglass with F-G 62.5/125 2.6 dB/km F600) 2800 m (fiberglass with F-G 50/125 1.6 dB/km F800)
Other connections	
Serial (RS-232)	RS-232-C, 6-pos. MINI-DIN socket (PS/2)
Function	
Basic functions	Store-and-forward switch complies with IEEE 802.3, 2 priority classes according to IEEE 802.1p, TCP/IP protocol, BootP-compatible, port mirroring, integrated web server function, multicast filtering, IGMP snooping, VLAN, Rapid Spanning Tree (RSTP), DHCP server, PTCP filter
Redundancy	Rapid Spanning Tree 802.1w, Fast Ring Detection
Status and diagnostics indicators	LEDs: US1, US2 (power supply), fail (alarm contact), 2 LEDs per Ethernet port (link/activity and speed)
Power supply	
Supply voltage	24 V DC (redundant)
Residual ripple	3.6 V _{PP}
Supply voltage range	18.5 V DC ... 30.5 V DC
Typical current consumption	250 mA (at U _S = 24 V DC)
General data	
Dimensions	W / H / D 45 mm / 99 mm / 112 mm
Degree of protection	IP20
Ambient temperature (operation)	-40 °C ... 70 °C
Permissible humidity (operation)	30 % ... 95 % (non-condensing)
EMC note	Class A product, see page 527
Noise emission	EN 61000-6-3/-4
Noise immunity	EN 61000-6-2:2005

Technical data

FL SWITCH LM 4TX/2FX SM FL SWITCH LM 4TX/2FX SM ST

Ethernet interface	
Number of ports	4 (RJ45 ports)
Transmission speed	10/100 Mbps
Fiber optic interface	
Number of ports	2 (SC single mode) 2 (ST single mode)
Transmission speed	100 Mbps (full duplex)
Wavelength	1300 nm
Transmission length	36000 m (fiberglass with F-G 9/125 0.36 dB/km) 32000 m (fiberglass with F-G 9/125 0.4 dB/km) 26000 m (fiberglass with F-G 9/125 0.5 dB/km)
Other connections	
Serial (RS-232)	RS-232-C, 6-pos. MINI-DIN socket (PS/2)
Function	
Basic functions	Store-and-forward switch complies with IEEE 802.3, 2 priority classes according to IEEE 802.1p, TCP/IP protocol, BootP-compatible, port mirroring, integrated web server function, multicast filtering, IGMP snooping, VLAN, Rapid Spanning Tree (RSTP), DHCP server, PTCP filter
Redundancy	Rapid Spanning Tree 802.1w, Fast Ring Detection
Status and diagnostics indicators	LEDs: US1, US2 (power supply), fail (alarm contact), 2 LEDs per Ethernet port (link/activity and speed)
Power supply	
Supply voltage	24 V DC (redundant)
Residual ripple	3.6 V _{PP}
Supply voltage range	18.5 V DC ... 30.5 V DC
Typical current consumption	250 mA (at U _S = 24 V DC)
General data	
Dimensions	W / H / D 45 mm / 99 mm / 112 mm
Degree of protection	IP20
Ambient temperature (operation)	-40 °C ... 70 °C
Permissible humidity (operation)	30 % ... 95 % (non-condensing)
EMC note	Class A product, see page 527
Noise emission	EN 61000-6-3/-4
Noise immunity	EN 61000-6-2:2005

Ordering data

Description	Type	Order No.	Pcs. / Pkt.
Lean Managed Switch			
- 4 RJ45 ports, 2 SC FO ports	FL SWITCH LM 4TX/2FX	2832658	1
- 4 RJ45 ports, 2 ST FO ports	FL SWITCH LM 4TX/2FX ST	2989132	1
Lean Managed Switch, preconfigured for Ethernet/IP			
- 4 RJ45 ports, 2 SC FO ports	FL SWITCH LM 4TX/2FX-E	2891660	1
- 4 RJ45 ports, 2 ST FO ports	FL SWITCH LM 4TX/2FX ST-E	2989931	1

Ordering data

Description	Type	Order No.	Pcs. / Pkt.
Lean Managed Switch			
- 4 RJ45 ports, 2 SC FO ports	FL SWITCH LM 4TX/2FX SM	2891916	1
- 4 RJ45 ports, 2 ST FO ports	FL SWITCH LM 4TX/2FX SM ST	2989239	1
Lean Managed Switch, preconfigured for Ethernet/IP			
- 4 RJ45 ports, 2 SC FO ports	FL SWITCH LM 4TX/2FX SM-E	2891864	1
- 4 RJ45 ports, 2 ST FO ports	FL SWITCH LM 4TX/2FX SM ST-E	2989938	1

Smart Managed Switches

The Smart Managed Narrow switch **FL SWITCH SMN 8TX-PN** is an Ethernet switch suitable for industrial applications with eight Fast Ethernet ports in RJ45 format. The switch is optimized for use in PROFINET RT and EtherNet/IP™ applications.

The switch has PROFINET mode activated by default.

Ethernet



8 RJ45 ports

Ethernet



6 RJ45 Ports and 2 FO Ports



Technical data	
Ethernet interface	
Number of ports	8 (RJ45 ports)
Transmission speed	10/100 Mbps
Fiber optic interface	
Number of ports	-
Transmission speed	-
Wavelength	-
Transmission length	-
Other connections	
Serial (RS-232)	RS-232-C, 6-pos. MINI-DIN socket (PS/2)
Function	
Basic functions	Store-and-forward switch complies with IEEE 802.3 4 priority classes according to IEEE 802.1 P TCP/IP protocol, BootP-capable, port-mirroring, integrated web server function, multicast filtering, IGMP snooping, VLAN, Rapid Spanning Tree (RSTP), PROFINET Device, Media Redundancy Protocol (MRP).
Status and diagnostics indicators	LEDs: US1, US2 (power supply), fail (alarm contact), 2 LEDs per Ethernet port (link and switchable activity/speed/duplex)
Power supply	
Supply voltage	24 V DC (redundant)
Residual ripple	3.6 V _{PP}
Supply voltage range	18 V DC ... 32 V DC
Typical current consumption	320 mA (at U _S = 24 V DC)
General data	
Dimensions	W / H / D 56 mm / 133 mm / 125 mm
Degree of protection	IP20
Ambient temperature (operation)	0 °C ... 55 °C (non-condensing)
Permissible humidity (operation)	5 % ... 95 % (non-condensing)
EMC note	Class A product, see page 527
Noise emission	EN 61000-6-3 +A11
Noise immunity	EN 61000-6-2:2005



Technical data	
Ethernet interface	
Number of ports	6 (RJ45 ports)
Transmission speed	10/100 Mbps
Fiber optic interface	
Number of ports	2 (SCRJ)
Transmission speed	10/100 Mbps (full duplex)
Wavelength	650 nm
Transmission length	Up to 250 m (depending on the fiber used)
Other connections	
Serial (RS-232)	RS-232-C, 6-pos. MINI-DIN socket (PS/2)
Function	
Basic functions	Store-and-forward switch complies with IEEE 802.3 4 priority classes according to IEEE 802.1 P TCP/IP protocol, BootP-capable, port-mirroring, integrated web server function, multicast filtering, IGMP snooping, VLAN, Rapid Spanning Tree (RSTP), PROFINET Device, Media Redundancy Protocol (MRP).
Status and diagnostics indicators	LEDs: US1, US2 (power supply), fail (alarm contact), 2 LEDs per Ethernet port (link and switchable activity/speed/duplex)
Power supply	
Supply voltage	24 V DC (redundant)
Residual ripple	3.6 V _{PP}
Supply voltage range	18 V DC ... 32 V DC
Typical current consumption	320 mA (at U _S = 24 V DC)
General data	
Dimensions	W / H / D 56 mm / 133 mm / 125 mm
Degree of protection	IP20
Ambient temperature (operation)	0 °C ... 55 °C (non-condensing)
Permissible humidity (operation)	5 % ... 95 % (non-condensing)
EMC note	Class A product, see page 527
Noise emission	EN 61000-6-3 +A11
Noise immunity	EN 61000-6-2:2005

Ordering data

Type	Order No.	Pcs. / Pkt.
FL SWITCH SMN 8TX-PN	2989501	1

Ordering data

Type	Order No.	Pcs. / Pkt.
FL SWITCH SMN 6TX/2POF-PN	2700290	1

Accessories

Accessories	Order No.	Pcs. / Pkt.
FL MEM PLUG	2891259	1
FL MEM PLUG/MRM	2891275	1

Accessories

Accessories	Order No.	Pcs. / Pkt.
FL MEM PLUG	2891259	1
FL MEM PLUG/MRM	2891275	1

Description
Smart Managed Narrow Switch
- 8 RJ45 ports
- 6 RJ45 ports, 2 POF FO ports

Configuration memory, replaceable
Configuration memory, can be replaced with MRM function

Smart Managed Switches offer excellent realtime properties with high data throughput at the same time.

The industrial DIN rail switches support Fast Ethernet or Gigabit on all ports and are ideal for use in the PROFINET RT or EtherNet/IP™ environment.

The **FL SWITCH SMCS 8GT** and **6GT/2SFP** Gigabit versions also have maritime approvals GL, BV, ABS, LR, and DNV.

All eight-port versions of the SMCS switches can be used in Ex zone II.

All devices support:

- RSTP
- MRP (client and master)
- VLANs
- SNMP

Ethernet



8 RJ45 ports



Ethernet interface
Number of ports
Transmission speed
Fiber optic interface
Number of ports
Transmission speed
Wavelength
Transmission length

Other connections
Serial (RS-232)
Function
Basic functions

Status and diagnostics indicators

Power supply	
Supply voltage	
Residual ripple	
Supply voltage range	
Typical current consumption	
General data	
Dimensions	W / H / D
Degree of protection	
Ambient temperature (operation)	
Permissible humidity (operation)	
Noise emission	
Noise immunity	

Technical data

FL SWITCH SMCS 8GT	FL SWITCH SMCS 8TX
8 (RJ45 ports)	
10/100/1000 Mbps	10/100 Mbps
-	-
-	-
-	-
-	-

Store-and-forward switch complies with IEEE 802.3 4 priority classes according to IEEE 802.1 P TCP/IP protocol, BootP-capable, port-mirroring, integrated web server function, multicast filtering, IGMP snooping, VLAN, Rapid Spanning Tree (RSTP), PROFINET Device, Media Redundancy Protocol (MRP).

LEDs: US1, US2 (power supply), fail (alarm contact), 2 LEDs per Ethernet port (link and switchable activity/speed/duplex)

Ordering data

Type	Order No.	Pcs. / Pkt.
FL SWITCH SMCS 8TX	2989226	1
FL SWITCH SMCS 8GT	2891123	1

Description
Smart Managed Compact Switch
- 8 RJ45 ports
- 8 RJ45 ports, 1000 Mbps
- 6 RJ45 ports, 2 SFP fiber optics ports
- 6 RJ45 ports, 2 SFP fiber optics ports, 1000 Mbps
- 16 RJ45 ports
- 14 RJ45 ports, 2 SC fiber optics ports (multi mode)
- 14 RJ45 ports, 2 SC FO ports (single mode)

Accessories

Slot module for synchronization port
- Wavelength 850 nm (short)
- Wavelength 1300 nm (long)
- Wavelength 1550 nm (longhaul), 1000 Mbps, single mode (80 km)
Configuration memory, replaceable
Configuration memory, can be replaced with MRM function

Type	Order No.	Pcs. / Pkt.
FL MEM PLUG	2891259	1
FL MEM PLUG/MRM	2891275	1

Ethernet



6 RJ45 ports and 2 SFP slots

Ethernet



16 RJ45 ports

Ethernet



14 RJ45 ports and 2 FO ports



Technical data	
FL SWITCH SMCS 6GT/2SFP	FL SWITCH SMCS 6TX/2SFP
6 (RJ45 ports)	10/100/1000 Mbps
2 (SFP ports)	1000 Mbps (full duplex)
Up to 80 km (depending on the fiber/SFP module used)	
RS-232-C, 6-pos. MINI-DIN socket (PS/2)	
Store-and-forward switch complies with IEEE 802.3 4 priority classes according to IEEE 802.1 P TCP/IP protocol, BootP-capable, port-mirroring, integrated web server function, multicast filtering, IGMP snooping, VLAN, Rapid Spanning Tree (RSTP), PROFINET Device, Media Redundancy Protocol (MRP).	
LEDs: US1, US2 (power supply), fail (alarm contact), 2 LEDs per Ethernet port (link and switchable activity/speed/duplex)	
24 V DC (redundant)	3.6 V _{PP}
18 V DC ... 32 V DC	650 mA (at U _S = 24 V DC)
128 mm / 110 mm / 69 mm	IP20
0 °C ... 55 °C (non-condensing)	5 % ... 95 % (non-condensing)
EN 61000-6-3 +A11 EN 61000-6-2:2005	

Technical data	
FL SWITCH SMCS 16TX	
16 (RJ45 ports)	10/100 Mbps
RS-232-C, 6-pos. MINI-DIN socket (PS/2)	
Store-and-forward switch complies with IEEE 802.3 4 priority classes according to IEEE 802.1 P TCP/IP protocol, BootP-capable, port-mirroring, integrated web server function, multicast filtering, IGMP snooping, VLAN, Rapid Spanning Tree (RSTP), PROFINET Device, Media Redundancy Protocol (MRP).	
LEDs: US1, US2 (power supply), fail (alarm contact), 2 LEDs per Ethernet port (link and switchable activity/speed/duplex)	
24 V DC (redundant)	3.6 V _{PP}
18 V DC ... 32 V DC	190 mA (at U _S = 24 V DC)
214 mm / 110 mm / 69 mm	IP20
-40 °C ... 70 °C (non-condensing)	5 % ... 95 % (non-condensing)
EN 61000-6-3 EN 61000-6-2:2005	

Technical data	
FL SWITCH SMCS 14TX/2FX	FL SWITCH SMCS 14TX/2FX-SM
14 (RJ45 ports)	10/100 Mbps
2 (SC multi mode)	2 (SC single mode)
10000 m (depending on the fiber used)	36000 m (fiberglass with F-G 9/125 0.36 dB/km)
6400 m (fiberglass with F-G 50/125 0.7 dB/km F1200)	32000 m (fiberglass with F-G 9/125 0.4 dB/km)
RS-232-C, 6-pos. MINI-DIN socket (PS/2)	
Store-and-forward switch complies with IEEE 802.3 4 priority classes according to IEEE 802.1 P TCP/IP protocol, BootP-capable, port-mirroring, integrated web server function, multicast filtering, IGMP snooping, VLAN, Rapid Spanning Tree (RSTP), PROFINET Device, Media Redundancy Protocol (MRP).	
LEDs: US1, US2 (power supply), fail (alarm contact), 2 LEDs per Ethernet port (link and switchable activity/speed/duplex)	
24 V DC (redundant)	3.6 V _{PP}
18 V DC ... 32 V DC	260 mA (at U _S = 24 V DC)
214 mm / 110 mm / 69 mm	IP20
-40 °C ... 70 °C (non-condensing)	5 % ... 95 % (non-condensing)
EN 61000-6-3 EN 61000-6-2:2005	

Ordering data		
Type	Order No.	Pcs. / Pkt.
FL SWITCH SMCS 6TX/2SFP	2989323	1
FL SWITCH SMCS 6GT/2SFP	2891479	1

Ordering data		
Type	Order No.	Pcs. / Pkt.
FL SWITCH SMCS 16TX	2700996	1

Ordering data		
Type	Order No.	Pcs. / Pkt.
FL SWITCH SMCS 14TX/2FX	2700997	1
FL SWITCH SMCS 14TX/2FX-SM	2701466	1

Accessories		
Type	Order No.	Pcs. / Pkt.
FL SFP SX	2891754	1
FL SFP LX	2891767	1
FL SFP LH	2989912	1
FL MEM PLUG	2891259	1
FL MEM PLUG/MRM	2891275	1

Accessories		
Type	Order No.	Pcs. / Pkt.
FL MEM PLUG	2891259	1
FL MEM PLUG/MRM	2891275	1

Accessories		
Type	Order No.	Pcs. / Pkt.
FL MEM PLUG	2891259	1
FL MEM PLUG/MRM	2891275	1

Switches for PROFINET IRT

The new IRT switches are particularly suitable for high-performance PROFINET networks.

The FL SWITCH IRT switches use built-in ERTEC (Enhanced Real Time Ethernet Controller) technology to forward PROFINET data packets at the fastest possible speeds via the cut through process.

In addition, PROFINET data packets are always delivered with the highest priority to the receiver independently of other data traffic.

The FL SWITCH IRT switches can be fully configured and monitored via STEP7 and PC Worx.

Features:

- Easy integration into a PROFINET network
- Extended temperature range (-25°C ... 60°C)
- POF interfaces for use in areas heavily affected by EMC
- Path length measurement
- Fiber optic diagnostics
- MRP client

Ethernet interface	
Number of ports	4 (RJ45 ports)
Transmission speed	10/100 Mbps
Fiber optic interface	
Number of ports	-
Transmission speed	-
Wavelength	-
Transmission length	-
Function	
Basic functions	
Status and diagnostics indicators	
LEDs: US1, US2 (power supply), fail (alarm contact), 3 LEDs per Ethernet port (Link, Activity, and FO status), and BF (Bus Fail)	
Power supply	
Supply voltage	24 V DC (redundant)
Residual ripple	3,6 V _{PP}
Supply voltage range	18.5 V DC ... 30.2 V DC
Typical current consumption	165 mA (at U _S = 24 V DC)
General data	
Dimensions	W / H / D 127 mm / 95 mm / 69 mm
Degree of protection	IP20
Ambient temperature (operation)	-25 °C ... 60 °C
Permissible humidity (operation)	5 % ... 95 % (non-condensing)
EMC note	Class A product, see page 527

Description	
Ethernet switch for PROFINET applications	
- 4 RJ45 ports	
- 2 RJ45 ports, 2 POF SCRJ ports	
- 1 RJ45 port, 3 POF SCRJ ports	

Configuration memory, replaceable	
Configuration memory, can be replaced with MRM function	

Ethernet



4 RJ45 Ports

PROFINET

Technical data	
Cut-through/store-and-forward switch complies with IEEE 802.3 2 priority classes according to IEEE802.1 P, TCP/IP protocol, DCP capable, integrated web server function, PROFINET device.	
LEDs: US1, US2 (power supply), fail (alarm contact), 3 LEDs per Ethernet port (Link, Activity, and FO status), and BF (Bus Fail)	

Power supply	
Supply voltage	24 V DC (redundant)
Residual ripple	3,6 V _{PP}
Supply voltage range	18.5 V DC ... 30.2 V DC
Typical current consumption	165 mA (at U _S = 24 V DC)
General data	
Dimensions	W / H / D 127 mm / 95 mm / 69 mm
Degree of protection	IP20
Ambient temperature (operation)	-25 °C ... 60 °C
Permissible humidity (operation)	5 % ... 95 % (non-condensing)
EMC note	Class A product, see page 527

Ordering data		
Type	Order No.	Pcs. / Pkt.
FL SWITCH IRT 4TX	2700689	1

Accessories		
FL MEM PLUG	2891259	1
FL MEM PLUG/MRM	2891275	1

Ethernet



2 RJ45 ports and 2 POF SC-RJ ports

Ethernet



1 RJ45 port and 3 POF SC-RJ ports

Ethernet



1 RJ45 port and 3 POF SC-RJ ports, for wall mounting



Technical data
2 (RJ45 ports) 10/100 Mbps
2 (SCRJ) 100 Mbps (full duplex) 650 nm Up to 250 m (depending on the fiber used)
Cut-through/store-and-forward switch complies with IEEE 802.3 2 priority classes according to IEEE802.1 P, TCP/IP protocol, DCP capable, integrated web server function, PROFINET device.
LEDs: US1, US2 (power supply), fail (alarm contact), 3 LEDs per Ethernet port (Link, Activity, and FO status), and BF (Bus Fail)
24 V DC (redundant) 3.6 V _{PP} 18.5 V DC ... 30.2 V DC 235 mA (at U _S = 24 V DC)
127 mm / 95 mm / 69 mm IP20 -25 °C ... 60 °C 5 % ... 95 % (non-condensing) Class A product, see page 527

Technical data
1 (RJ45 ports) 10/100 Mbps
3 (SCRJ) 100 Mbps (full duplex) 650 nm Up to 250 m (depending on the fiber used)
Cut-through/store-and-forward switch complies with IEEE 802.3 2 priority classes according to IEEE802.1 P, TCP/IP protocol, DCP capable, integrated web server function, PROFINET device.
LEDs: US1, US2 (power supply), fail (alarm contact), 3 LEDs per Ethernet port (Link, Activity, and FO status), and BF (Bus Fail)
24 V DC (redundant) 3.6 V _{PP} 18.5 V DC ... 30.2 V DC 270 mA (at U _S = 24 V DC)
127 mm / 95 mm / 69 mm IP20 -25 °C ... 60 °C 5 % ... 95 % (non-condensing) Class A product, see page 527

Technical data
1 (RJ45 ports) 10/100 Mbps
3 (SCRJ) 100 Mbps (full duplex) 650 nm Up to 250 m (depending on the fiber used)
Cut-through/store-and-forward switch complies with IEEE 802.3 2 priority classes according to IEEE802.1 P, TCP/IP protocol, DCP capable, integrated web server function, PROFINET device.
LEDs: US1, US2 (power supply), fail (alarm contact), 3 LEDs per Ethernet port (Link, Activity, and FO status), and BF (Bus Fail)
24 V DC (redundant) 3.6 V _{PP} 18.5 V DC ... 30.2 V DC 260 mA (at U _S = 24 V DC)
176 mm / 112 mm / 99 mm IP67 -25 °C ... 60 °C 5 % ... 95 % (non-condensing) Class A product, see page 527

Ordering data		
Type	Order No.	Pcs. / Pkt.
FL SWITCH IRT 2TX 2POF	2700691	1

Ordering data		
Type	Order No.	Pcs. / Pkt.
FL SWITCH IRT TX 3POF	2700692	1

Ordering data		
Type	Order No.	Pcs. / Pkt.
FL SWITCH IRT IP TX/3POF	2700697	1

Accessories		
	Order No.	Pcs. / Pkt.
FL MEM PLUG	2891259	1
FL MEM PLUG/MRM	2891275	1

Accessories		
	Order No.	Pcs. / Pkt.
FL MEM PLUG	2891259	1
FL MEM PLUG/MRM	2891275	1

Accessories		
	Order No.	Pcs. / Pkt.
FL MEM PLUG	2891259	1
FL MEM PLUG/MRM	2891275	1

The automation switches in the 7000 series are the first switches to support direct integration into a Device Level Ring (DLR). Direct integration of the switches into the DLR is a considerable advantage when installing and operating EtherNet/IP™ networks.

Up to six devices can be integrated into a DLR via the FL SWITCH 7000. In system networks, the switches allow the redundant rings to be connected to the higher-level networking level. In this way, you can create networks with minimal switch-over times of less than three milliseconds (< 3 ms).

The Managed Switches of the 7000 series communicate directly via the Common Industrial Protocol (CIP) in the EtherNet/IP™ network. Via CIP, you can integrate the switch into an EtherNet/IP™ control system from where it can be configured and diagnosed.

Pure copper versions and versions with up to three fiberglass ports are available for flexible use.

Features:

- Slim design
- Extended temperature range (-40 °C ... +70 °C)
- VLANs
- Common Industrial Protocol (CIP)
- Device Level Ring (DLR)
- RSTP
- Web-based management



Ethernet

EtherNet/IP™

8 RJ45 ports



Technical data			
Ethernet interface			
Number of ports	8 (RJ45 ports)		
Transmission speed	10/100 Mbps		
Fiber optic interface			
Number of ports	-		
Transmission speed	-		
Wavelength	-		
Transmission length	-		
Fiber optic interface			
Number of ports	-		
Transmission speed	-		
Wavelength	-		
Transmission length	-		
Function			
Basic functions	Store-and-forward switch, complies with IEEE 802.3		
Management	Web-based management (HTTP) SNMP v1/v2 Remanent event table RMON History N:1 Port Mirroring LLDP (Link Layer Discovery Protocol) SNMP Traps ACD (Address Conflict Detection) DLR (Device Level Ring) RSTP (Rapid Spanning Tree) FRD (Fast Ring Detection) Large Tree Support CIP (Common Industrial Protocol) IGMP Snooping (512 groups) IGMP Query Auto Query Port Static Multicast Filtering (32 groups) Multicast Source Detection		
Diagnostics function	DHCP Option 82 (Relay Agent) Link aggregation (up to 4 trunks) BootP DHCP-Client MAC-based Port Security		
Redundancy	LEDs: US1, US2 (power supply), fail (alarm contact), 2 LEDs per Ethernet port (link and switchable activity/speed/duplex) EtherNet/IP™ status LED: Net, Mod		
Device function			
Additional function			
Status and diagnostics indicators			
Power supply			
Supply voltage	24 V DC (redundant)		
Residual ripple	3.6 V _{pp}		
Supply voltage range	12 V DC ... 58 V DC		
Typical current consumption	350 mA (at U _S = 24 V DC)		
General data			
Dimensions	60 mm / 130 mm / 135.5 mm		
Degree of protection	IP20		
Ambient temperature (operation)	-40 °C ... 70 °C		
Permissible humidity (operation)	10 % ... 95 % (non-condensing)		
EMC note	Class A product, see page 527		
Noise emission	EN 61000-6-4		
Noise immunity	EN 61000-6-2:2005		
Ordering data			
Description			
Advanced Managed Switch			
Type	Order No.	Pcs. / Pkt.	
FL SWITCH 7008-EIP	2701418	1	
Accessories			
Parameterization memory, replaceable	SD FLASH 512MB	2988146	1

Ethernet

EtherNet/IP



6 RJ45 ports and 2 fiber optic ports (multi mode)

Ethernet

EtherNet/IP



5 RJ45 ports and 1 fiber optic port (multi mode), 2 fiber optic ports (single mode)

Ex:

Ex:

Technical data

6 (RJ45 ports) 10/100 Mbps
2 (SC multi mode) 100 Mbps (full duplex) 1300 nm 11000 m (fiberglass with F-G 62.5/125 0.7 dB/km F1000)
-
-
-

Store-and-forward switch, complies with IEEE 802.3

Web-based management (HTTP)
SNMP v1/v2
Remanent event table
RMON History
N:1 Port Mirroring
LLDP (Link Layer Discovery Protocol)
SNMP Traps
ACD (Address Conflict Detection)
DLR (Device Level Ring)
RSTP (Rapid Spanning Tree)
FRD (Fast Ring Detection)
Large Tree Support
CIP (Common Industrial Protocol)
IGMP Snooping (512 groups)
IGMP Query
Auto Query Port
Static Multicast Filtering (32 groups)
Multicast Source Detection
DHCP Option 82 (Relay Agent)
Link aggregation (up to 4 trunks)
BootP
DHCP-Client
MAC-based Port Security
LEDs: US1, US2 (power supply), fail (alarm contact), 2 LEDs per Ethernet port (link and switchable activity/speed/duplex)
EtherNet/IP™ status LED: Net, Mod

24 V DC (redundant) 3.6 V _{pp} 12 V DC ... 58 V DC 470 mA (at U _s = 24 V DC)

60 mm / 130 mm / 135.5 mm IP20 -40 °C ... 70 °C 10 % ... 95 % (non-condensing) Class A product, see page 527 EN 61000-6-4 EN 61000-6-2:2005

Ordering data

Type	Order No.	Pcs. / Pkt.
FL SWITCH 7006/2FX-EIP	2701419	1

Accessories

SD FLASH 512MB	2988146	1
----------------	---------	---

Technical data

5 (RJ45 ports) 10/100 Mbps
1 (SC multi mode) 100 Mbps (full duplex) 1300 nm 11000 m (fiberglass with F-G 62.5/125 0.7 dB/km F1000)
2 (SC single mode) 100 Mbps (full duplex) 1300 nm 36000 m (fiberglass with F-G 9/125 0.36 dB/km)

Store-and-forward switch, complies with IEEE 802.3

Web-based management (HTTP)
SNMP v1/v2
Remanent event table
RMON History
N:1 Port Mirroring
LLDP (Link Layer Discovery Protocol)
SNMP Traps
ACD (Address Conflict Detection)
DLR (Device Level Ring)
RSTP (Rapid Spanning Tree)
FRD (Fast Ring Detection)
Large Tree Support
CIP (Common Industrial Protocol)
IGMP Snooping (512 groups)
IGMP Query
Auto Query Port
Static Multicast Filtering (32 groups)
Multicast Source Detection
DHCP Option 82 (Relay Agent)
Link aggregation (up to 4 trunks)
BootP
DHCP-Client
MAC-based Port Security
LEDs: US1, US2 (power supply), fail (alarm contact), 2 LEDs per Ethernet port (link and switchable activity/speed/duplex)
EtherNet/IP™ status LED: Net, Mod

24 V DC (redundant) 3.6 V _{pp} 12 V DC ... 58 V DC 520 mA (at U _s = 24 V DC)

60 mm / 130 mm / 135.5 mm IP20 -40 °C ... 70 °C 10 % ... 95 % (non-condensing) Class A product, see page 527 EN 61000-6-4 EN 61000-6-2:2005

Ordering data

Type	Order No.	Pcs. / Pkt.
FL SWITCH 7005/FX-2FXSM-EIP	2701420	1

Accessories

SD FLASH 512MB	2988146	1
----------------	---------	---

Routers

The NAT switch combines the functions of a NAT router and a switch in a single device. Thanks to 1:1 NAT or virtual NAT, the **FL NAT SMN 8TX** enables individual machines or systems to always be assigned the same IP addresses and for these IP addresses to then be implemented in the IP address area of the higher-level company network.

Gigabit Modular Switches

The high-performance Gigabit Modular Switch can be extended to up to 28 ports with any transmission medium.

Features:

- Up to 12 integrated ports with 1000 Mbps data transmission
- Connection of connection media that can be assembled in the field, such as POF, HCS, and GI HCS
- Connection of Gigabit fiberglass via FL SFP plug-in modules
- Quick and easy local configuration options with the new operator/display interface
- Security in the automation network according to IEEE 802.1X
- Optional Layer 3 functions can be activated

Ethernet



NAT switch with 8 RJ45 ports



Technical data	
SFP interface	
Number of ports	-
Transmission speed	-
Copper interface	
Number of ports	8 (RJ45 ports)
Transmission speed	10/100 Mbps
Interface extension	
Number of ports	-
Note on connection method	-
Transmission speed	-
Transmission physics	-

Function	
Basic functions	Store and forward switch, complies with IEEE 802.3 2, priority classes according to IEEE 802.1 P TCP/IP protocol, BootP-capable, integrated web server function, Rapid Spanning Tree (RSTP), router, 1:1 NAT router

Power supply	
Supply voltage	24 V DC (redundant)
Supply voltage range	18 V DC ... 32 V DC
Typical current consumption	600 mA (at U _S = 24 V DC)

General data	
Dimensions	W / H / D 58 mm / 133 mm / 130 mm
Degree of protection	IP20
Ambient temperature (operation)	0 °C ... 55 °C (non-condensing)
Noise emission	EN 61000-6-3 +A11
Noise immunity	EN 61000-6-2:2005

Description	Ordering data		
	Type	Order No.	Pcs. / Pkt.
Smart Managed Narrow NAT switch with 1:1 NAT router function			
- 8 RJ45 ports			
Gigabit Modular Switch			
- 4 Gigabit ports and 12 Fast Ethernet ports	FL NAT SMN 8TX	2989365	1
- 12 Gigabit ports and 8 Fast Ethernet ports			
Extension			
- 8 Ethernet ports			

Accessories			
	Type	Order No.	Pcs. / Pkt.
Slot module for synchronization port			
- Distances of up to 550 m			
- Distances of up to 30 km			
- Distances of up to 80 km			
Parameterization memory , replaceable	FL MEM PLUG	2891259	1
Parameterization memory , can be replaced with MRM function			
Parameterization memory , can be replaced with MRM and Layer 3 function			



EtherNet/IP



Head station, 8 - 16 ports



EtherNet/IP



Head station, 12 - 20 ports

Ethernet



Extension, 8 ports

ERIE PROFenergy PROFINET

ERIE PROFenergy PROFINET

ERIE

Technical data

4 (SFP ports or RJ45 ports)
1000 Mbps (full duplex)

4 (RJ45 ports)
10/100 Mbps

2 (per interface module)
Max. 4 interface modules (without extension)
10/100 Mbps (full duplex)
multi-mode fiberglass
Single-mode fiberglass
POF-SCRJ
GI-HCS fibers
Copper
PoE

Store-and-forward switch complies with IEEE 802.3, 8 priority classes according to IEEE 802.1p, smart mode, port mirroring, multicast filtering, IGMP snooping, VLANs, Media Redundancy Protocol (MRP according to IEC 62439), Rapid Spanning Tree (RSTP), Fast Ring Detection (FRD), Large Tree Support, IEEE 802.1X security, port security, SNMPv3, HTTPS, PROFINET device, GMRP, GVRP, SNTP, 2 digital inputs

24 V DC (redundant)
18.5 V DC ... 30.2 V DC
800 mA (up to 2.5 A, depends on the configuration)

287 mm / 125 mm / 115 mm
IP20
-20 °C ... 55 °C (non-condensing)
EN 61000-6-3/-4
EN 61000-6-2:2005

Technical data

4 (SFP ports)
1000 Mbps (full duplex)

8 (RJ45 ports)
10/100/1000 Mbps

2 (per interface module)
Max. 4 interface modules (without extension)
10/100 Mbps (full duplex)
multi-mode fiberglass
Single-mode fiberglass
POF-SCRJ
GI-HCS fibers
Copper
PoE

Store-and-forward switch complies with IEEE 802.3, 8 priority classes according to IEEE 802.1p, smart mode, port mirroring, multicast filtering, IGMP snooping, VLANs, Media Redundancy Protocol (MRP according to IEC 62439), Rapid Spanning Tree (RSTP), Fast Ring Detection (FRD), Large Tree Support, IEEE 802.1X security, port security, SNMPv3, HTTPS, PROFINET device, GMRP, GVRP, SNTP, 2 digital inputs

24 V DC (redundant)
18.5 V DC ... 30.2 V DC
800 mA (up to 2.7 A, depends on the configuration)

287 mm / 125 mm / 115 mm
IP20
-20 °C ... 55 °C (non-condensing)
EN 61000-6-3/-4
EN 61000-6-2:2005

Technical data

-
-
-
-
2 (per interface module)
Max. 4 interface modules
10/100 Mbps (full duplex)
multi-mode fiberglass
Single-mode fiberglass
POF-SCRJ
GI-HCS fibers
Copper
PoE

Extension module for Modular Managed Switch

-
-
Via head station

127 mm / 125 mm / 115 mm
IP20
-20 °C ... 55 °C (non-condensing)
EN 61000-6-3/-4
EN 61000-6-2:2005

Ordering data

Type	Order No.	Pcs. / Pkt.
FL SWITCH GHS 4G/12	2700271	1
FL SWITCH GHS 4G/12-L3	2700786	1

Ordering data

Type	Order No.	Pcs. / Pkt.
FL SWITCH GHS 12G/8	2989200	1
FL SWITCH GHS 12G/8-L3	2700787	1

Ordering data

Type	Order No.	Pcs. / Pkt.
FL FXT	2989307	1

Accessories

Accessories	Order No.	Pcs. / Pkt.
FL SFP SX	2891754	1
FL SFP LX	2891767	1
FL SFP LH	2989912	1
SD FLASH 512MB	2988146	1
FL SD FLASH/MRM	2700270	1
FL SD FLASH/L3/MRM	2700607	1

Accessories

Accessories	Order No.	Pcs. / Pkt.
FL SFP SX	2891754	1
FL SFP LX	2891767	1
FL SFP LH	2989912	1
SD FLASH 512MB	2988146	1
FL SD FLASH/MRM	2700270	1
FL SD FLASH/L3/MRM	2700607	1

Accessories

Accessories	Order No.	Pcs. / Pkt.

Switch accessories

Interface modules

Highly modular 2-port interface modules allow a flexible cable outlet: Either downward or to the front, depending on the requirements of the installation and location. There are interface modules for twisted pairs, fiberglass or the cost-effective Ethernet installation with polymer and HCS fibers, all designed to carry out the particular job at hand.

Ethernet



TX ports

Ethernet



FO ports



	Technical data		Technical data	
	FL IF 2TX VS-RJ-F	FL IF 2PSE-F	FL IF 2FX SC-F	FL IF 2FX ST-D
Ethernet interface				
Number of ports	2 (RJ45 ports)	2 (PoE ports)	-	-
Transmission speed	10/100 Mbps (connection direction forwards)		-	-
Fiber optic interface				
Number of ports	-	-	2 (SC multi mode)	2 (ST multi mode)
Transmission speed	-	-	100 Mbps	1300 nm
Wavelength	-	-	2800 m (fiberglass with F-G 50/125 1.6 dB/km F800)	10000 m (fiberglass with F-G 62.5/125 0.7 dB/km F1000)
Transmission length	-	-	6400 m (fiberglass with F-G 50/125 0.7 dB/km F1200)	3000 m (fiberglass with F-G 62.5/125 2.6 dB/km F600)
	-	-	2800 m (fiberglass with F-G 50/125 1.6 dB/km F800)	
Function				
Basic functions	Media module for Modular Managed Switch	Media module for Modular Managed Switch with Power over Ethernet IEEE802.3af, Power Source Equipment (PSE)	Media module for Modular Managed Switch	
Power supply				
Power supply connection	From FL SWITCH GHS or FXT		From FL SWITCH GHS or FXT	
Supply voltage	Via head station	Internal / 48 V DC for PoE	Via head station	
Typical current consumption	10 mA	10 mA (Max. 900 mA)	200 mA	
General data				
Dimensions	W / H / D	31 mm / 75.7 mm / 75.5 mm	31 mm / 75.7 mm / 72.5 mm	31 mm / 83 mm / 72.5 mm
Degree of protection		IP20	IP20	
Ambient temperature (operation)		-20 °C ... 55 °C (non-condensing)	0 °C ... 55 °C (non-condensing)	
Permissible humidity (operation)		10 % ... 95 % (non-condensing)	10 % ... 95 % (non-condensing)	
EMC note		Class A product, see page 527	Class A product, see page 527	
Noise emission		EN 61000-6-3/-4	EN 61000-6-3/-4	
Noise immunity		EN 61000-6-2:2005	EN 61000-6-2:2005	

	Ordering data			Ordering data		
	Type	Order No.	Pcs. / Pkt.	Type	Order No.	Pcs. / Pkt.
Description						
Interface module for Modular Managed Switch system						
- Outlet to the front	FL IF 2TX VS-RJ-F	2832344	1			
- Outlet downward	FL IF 2TX VS-RJ-D	2832357	1			
- Power-over-Ethernet, outlet to the front	FL IF 2PSE-F	2832904	1			
FO media module for connecting 100Base-FX fiberglass (1300 nm)						
- Outlet at the front, SC multi mode				FL IF 2FX SC-F	2832412	1
- Outlet at the bottom, SC multi mode				FL IF 2FX SC-D	2832425	1
- Outlet at the bottom, ST multi mode				FL IF 2FX ST-D	2884033	1
- Outlet at the bottom, SC single mode				FL IF 2FX SM SC-D	2832205	1
Interface modules , 2 ports, SC-RJ for POF/PCF, diagnosis-capable						
Slot module for synchronization port						
- Wavelength 850 nm (short)						
- Wavelength 1300 nm (long)						
- Wavelength 1550 nm (longhaul), 1000 Mbps, single mode (80 km)						
- Wavelength 1300 nm, 100 Mbps, multi mode (2 km)						
- Wavelength 1300 nm, 100 Mbps, single mode (40 km)						
Configuration memory , replaceable						
- MRM function						

Ethernet



POF-SC-RJ ports



SFP modules for transmission ranges up to 80 km



Configuration memory and MRP manager function



Technical data

-
2 (SCRJ)
100 Mbps
650 nm
50 m (including 3 dB system reserve, polymer fiber with F-K 980/1000 230 dB/km)
100 m (HCS fiber with F-S 200/230 10 dB/km)
250 m (GI HCS fiber with F-S 200/300, with 15 dB/km)
-

Media module for Modular Managed Switch with FO diagnosis

From FL SWITCH GHS or FXT
Via head station
200 mA

31 mm / 73.5 mm / 72.5 mm
IP20
0 °C ... 55 °C (non-condensing)
10 % ... 95 % (non-condensing)
Class A product, see page 527
EN 61000-6-3/-4
EN 61000-6-2:2005

Ordering data

Type	Order No.	Pcs. / Pkt.
FL IF 2POF SCRJ-D	2891084	1

Technical data

FL SFP SX	FL SFP LX
-	-
1 (LC multi mode)	1 (LC single mode)
850 nm	1310 nm
550 m (fiberglass 50/125)	30 km (fiberglass 9/125)
300 m (fiberglass 62.5/125)	250 m (fiberglass 62.5/125)
-	-
-	-

SFP module as FO port

Via SFP slot

-40 °C ... 85 °C (non-condensing)
30 % ... 95 % (non-condensing)

Ordering data

Type	Order No.	Pcs. / Pkt.
FL SFP SX	2891754	1
FL SFP LX	2891767	1
FL SFP LH	2989912	1
FL SFP FX	2891081	1
FL SFP FX SM	2891082	1

Technical data

FL MEM PLUG	FL MEM PLUG/MRM
-	-
-	-
-	-
-	-
-	-
-	-

Configuration memory (plug-in) Configuration memory and manager for the media redundancy protocol (MRP)

From FL SWITCH MCS/SMCS

16 mm / 49 mm / -
IP20
0 °C ... 55 °C (non-condensing)
10 % ... 95 % (non-condensing)
Class A product, see page 527
EN 61000-6-3/-4
EN 61000-6-2:2005

Ordering data

Type	Order No.	Pcs. / Pkt.
FL MEM PLUG	2891259	1
FL MEM PLUG/MRM	2891275	1

Unmanaged switches

The **FL SWITCH 1008E** industrial unmanaged switch is designed for use in energy technology. With its robust design, it can be used in environments subject to high levels of EMI around switchgear that have been designed according to the new IEC 61850 standard.

Features:

- 8 RJ45 ports in metal housing with DIN rail adapter
- Extended temperature range (-40°C ... +75°C) for harsh environments
- Redundant power supply with a wide range from 12 ... 57 V DC (24, 36, 48 V DC)
- Robust design for high EMC requirements, such as electrostatic discharge with 15 kV air discharge and 8 kV contact discharge; surge withstand capability (surge) and fast transients (burst) up to 4 kV
- Floating alarm contact for power supply monitoring and diagnostics
- Link monitoring of every port for diagnostics via alarm LED and alarm contact can be configured via DIP switches

Notes:

A media converter which meets the same requirements that are required for switchgear and transformer substations in energy technology can be found on page 383

Ethernet

IEC 61850-3



8 RJ45 ports

Technical data			
Ethernet interface			
Number of ports	8 (RJ45 ports)		
Transmission speed	10/100 Mbps		
Connection method	RJ45		
Function			
Basic functions	Unmanaged switch / auto negotiation, complies with IEEE 802.3, store-and-forward switching mode, includes QoS and alarm contact. Meets IEC 61850-3 and IEEE 1613 standards		
Status and diagnostics indicators	LEDs: U _{S1} , U _{S2} (redundant voltage supply), link and activity per port		
Network expansion parameters			
Cascading depth	Network, linear, and star structure: any		
Maximum conductor length (twisted pair)	100 m		
Power supply			
Supply voltage	24 V DC (redundant) 48 V DC		
Residual ripple	3,6 V _{PP}		
Supply voltage range	12 V DC ... 57 V DC		
Typical current consumption	440 mA (at U _S = 24 V DC)		
General data			
Dimensions	W / H / D 54,4 mm / 146,4 mm / 125 mm		
Degree of protection	IP20		
Ambient temperature (operation)	-40 °C ... 75 °C		
Permissible humidity (operation)	5 % ... 95 % (non-condensing)		
Noise emission	EN 61000-6-4		
Noise immunity	IEC 61850-3, IEEE 1613, EN 61000-6-2: 2005		
Ordering data			
Description	Type	Order No.	Pcs. / Pkt.
Ethernet switch - 8 RJ45 ports	FL SWITCH 1008E	2891065	1

Managed switches

Ethernet switches control Ethernet traffic and maximize uptime. Operation in extreme environments is assured with a wide temperature range and an electrical noise immunity up to four times that of normal industrial switches.

Features:

- 15 ms recovery time with extended ring redundancy
- Extensive IEEE and security functions

Ethernet

IEC 61850-3



16 RJ45 ports

Ethernet

IEC 61850-3



12 RJ45 ports and 2 SFP (100 Mbps) ports

	Technical data	Technical data
Ethernet interface		
Number of ports	16 (RJ45 ports)	12 (RJ45 ports)
Transmission speed	10/100 Mbps (with auto negotiation)	10/100 Mbps (with auto negotiation)
Fiber optic interface		
Number of ports	-	2 (SFP ports)
Transmission speed	-	100 Mbps (full duplex)
Connection method	-	SFP ports
Function		
Basic functions	Store and forward switch, Extended Ring and IEEE redundancy, Multicast control, IGMP snooping, trunking, Port and Tagging VLANs, Port and IEEE 802.1x security, SNMP V3 and Https security, SNTP, web customization, user accounts	Store and forward switch, Extended Ring and IEEE redundancy, Multicast control, IGMP snooping, trunking, Port and Tagging VLANs, Port and IEEE 802.1x security, SNMP V3 and Https security, SNTP, web customization, user accounts
Status and diagnostics indicators	LEDs: U _{S1} , U _{S2} (redundant voltage supply), link and activity per port	LEDs: U _{S1} , U _{S2} (redundant voltage supply), link and activity per port
Network expansion parameters		
Cascading depth	Network, linear, and star structure: any	Network, linear, and star structure: any
Maximum conductor length (twisted pair)	100 m	100 m
Power supply		
Supply voltage	24 V DC (redundant)	24 V DC (redundant)
Residual ripple	3.6 V _{PP}	3.6 V _{PP}
Supply voltage range	12 V DC ... 48 V DC	12 V DC ... 48 V DC
Typical current consumption	312 mA (24 V DC)	312 mA (at U _S = 24 V DC)
General data		
Dimensions W / H / D	78 mm / 144 mm / 125 mm	66 mm / 173 mm / 140 mm
Degree of protection	IP20	IP20
Ambient temperature (operation)	-40 °C ... 70 °C	-40 °C ... 70 °C
Permissible humidity (operation)	5 % ... 95 % (non-condensing)	5 % ... 95 % (non-condensing)
EMC note	Class A product, see page 527	Class A product, see page 527
Noise emission	EN 61000-6-4	EN 61000-6-4
Noise immunity	IEC 61850-3, IEC 1613, EN 61000-6-2: 2005	IEC 61850-3, IEC 1613, EN 61000-6-2: 2005

	Ordering data			Ordering data		
Description	Type	Order No.	Pcs. / Pkt.	Type	Order No.	Pcs. / Pkt.
Managed switch - 16 RJ45 ports - 12 RJ45 and 2 SFP FO ports	FL SWITCH 3016E	2891066	1	FL SWITCH 3012E-2SFX	2891067	1
	Accessories			Accessories		
Redundancy module - 3 RJ45 ports - 1 RJ45 port, 2 LC fiber optic ports (multi mode)	FL RED 2003E PRP	2701863	1	FL RED 2003E PRP	2701863	1
	FL RED 2001E PRP 2LC	2701864	1	FL RED 2001E PRP 2LC	2701864	1

Managed Switches, 19" rack-mount

The FL SWITCH 4800E line of substation hardened, managed switches combine 24 ports of 10/100 Mbps device connections with four 10/100/1000 Mbps uplink ports for a total of 28 ports. Application flexibility is assured with different mixes of copper/fiber and fiber types, gigabit fiber/copper "combination" ports and modular power supplies. Operation in extreme environments is assured with a wide temperature range and an electrical noise immunity up to four times that of normal industrial switches.

Features:

- All switches have four Gigabit combo ports for network connections with high data throughput
- Flexible cabling using eight or 24 10/100 Mbps RJ45 connections with up to 16 fiber (100 Mbps) fiber connections
- 15 ms recovery time with extended ring redundancy
- Optional PRP redundancy modules provide 0 ms recovery times
- Extensive IEEE and security functions
- Unique web customization, diagnostic viewing mode, and help pages simplify maintenance
- Supports up to two modular, hot-swappable power supplies for maximum power flexibility and uptime
- Electrical noise immunity according to IEC 61850-3 and IEEE 1613
- Extended temperature range (-40 °C ... +70 °C)

Notes:
1) Requires the installation of at least one FL SWITCH 4800E-P1 or FL SWITCH 4800E-P5 for operation.

Ethernet

IEC 61850-3



24 RJ45 ports and 4 gigabit combo (SFP or RJ45) ports

Ethernet interface	
Number of ports	24 (RJ45 ports)
Transmission speed	10/100 Mbps
Ethernet (RJ45/FO combo)	
Interface	Ethernet (RJ45/FO combo)
Connection method	RJ45, shielded or SFP module (LC)
Note on connection method	Auto negotiation and autocrossing (RJ45 interface)
Fiber optic interface	
Number of ports	-
Transmission speed	-
Connection method	-
Transmission length	-
Function	
Basic functions	
Status and diagnostics indicators	
LEDs: U _{S1} , U _{S2} (redundant voltage supply), link and activity per port	
Network expansion parameters	
Cascading depth	Network, linear, and star structure: any
Maximum conductor length (twisted pair)	100 m
Power supply	
Power supply connection	From FL SWITCH 4800E-P...
General data	
Dimensions	W / H / D 442 mm / 44 mm / 375 mm
Degree of protection	IP20
Ambient temperature (operation)	-40 °C ... 70 °C
Permissible humidity (operation)	5 % ... 95 % (non-condensing)
Noise emission	EN 61000-6-4
Noise immunity	IEC 61850-3, IEEE 1613, EN 61000-6-2: 2005

Technical data

Technical data		
Ethernet interface		
Number of ports	24 (RJ45 ports)	
Transmission speed	10/100 Mbps	
Ethernet (RJ45/FO combo)		
Interface	Ethernet (RJ45/FO combo)	
Connection method	RJ45, shielded or SFP module (LC)	
Note on connection method	Auto negotiation and autocrossing (RJ45 interface)	
Fiber optic interface		
Number of ports	-	
Transmission speed	-	
Connection method	-	
Transmission length	-	
Function		
Basic functions		
Status and diagnostics indicators		
LEDs: U _{S1} , U _{S2} (redundant voltage supply), link and activity per port		
Network expansion parameters		
Cascading depth	Network, linear, and star structure: any	
Maximum conductor length (twisted pair)	100 m	
Power supply		
Power supply connection	From FL SWITCH 4800E-P...	
General data		
Dimensions	W / H / D 442 mm / 44 mm / 375 mm	
Degree of protection	IP20	
Ambient temperature (operation)	-40 °C ... 70 °C	
Permissible humidity (operation)	5 % ... 95 % (non-condensing)	
Noise emission	EN 61000-6-4	
Noise immunity	IEC 61850-3, IEEE 1613, EN 61000-6-2: 2005	

Description
Managed switch , 19-inch rack mounted - 24 RJ45 and 4 GB combo ports
Managed switch , 19-inch rack mounted with 8 RJ45 and 4 GB combo ports - 16 fiber optic (LC duplex) ports - 16 fiber optic (LC single-mode) ports - 16 fiber optic (SC duplex) ports - 16 fiber optic (SC single-mode) ports - 16 fiber optic (ST multi-mode) ports - 16 fiber optic (ST single-mode) ports

Ordering data

Type	Order No.	Pcs. / Pkt.
FL SWITCH 4824E-4GC ¹⁾	2891072	1

Power supply , modular redundant	
- 48 V DC nominal	2891075
- 230 V nominal	2891076
Redundancy module	
- 3 RJ45 ports	2701863
- 1 RJ45 port, 2 LC fiber optic ports (multi mode)	2701864

Accessories

FL SWITCH 4800E-P1	2891075	1
FL SWITCH 4800E-P5	2891076	1
FL RED 2003E PRP	2701863	1
FL RED 2001E PRP 2LC	2701864	1

Ethernet

IEC 61850-3



8 RJ45 ports, 4 gigabit combo (SFP or RJ45) ports and 16 LC FO ports

Ethernet

IEC 61850-3



8 RJ45 ports, 4 gigabit combo (SFP or RJ45) ports and 16 SC FO ports

Ethernet

IEC 61850-3



8 RJ45 ports, 4 gigabit combo (SFP or RJ45) ports and 16 ST FO ports

Technical data	
FL SWITCH 4808E-16FX LC-4GC ¹⁾	FL SWITCH 4808E-16FX SM LC-4GC ¹⁾
8 (RJ45 ports) 10/100 Mbps	
Ethernet (RJ45/FO combo) RJ45, shielded or SFP module (LC) Auto negotiation and autocrossing (RJ45 interface)	
16 (multi mode) 100 Mbps (Full duplex) LC	16 (single mode) 100 Mbps (Full duplex) LC
8 km (fiberglass with F-G 62.5/125 0.7 dB/km F1000)	40 km (typical)
Store and forward switch, Extended Ring and IEEE redundancy, Multicast control, IGMP snooping, trunking, Port and Tagging VLANs, Port and IEEE 802.1x security, SNMP V3 and Https security, SNTP, web customization, user accounts	
LEDs: U _{S1} , U _{S2} (redundant voltage supply), link and activity per port	
Network, linear, and star structure: any 100 m	
From FL SWITCH 4800E-P...	
442 mm / 44 mm / 375 mm IP20 -40 °C ... 70 °C 5 % ... 95 % (non-condensing) EN 61000-6-4 IEC 61850-3, IEEE 1613, EN 61000-6-2: 2005	

Technical data	
FL SWITCH 4808E-16FX-4GC ¹⁾	FL SWITCH 4808E-16FX SM-4GC ¹⁾
8 (RJ45 ports) 10/100 Mbps	
Ethernet (RJ45/FO combo) RJ45, shielded or SFP module (LC) Auto negotiation and autocrossing (RJ45 interface)	
16 (multi mode) 100 Mbps (Full duplex) SC	16 (single mode) 100 Mbps (Full duplex) SC
8 km (fiberglass with F-G 62.5/125 0.7 dB/km F1000)	40 km (typical)
Store and forward switch, Extended Ring and IEEE redundancy, Multicast control, IGMP snooping, trunking, Port and Tagging VLANs, Port and IEEE 802.1x security, SNMP V3 and Https security, SNTP, web customization, user accounts	
LEDs: U _{S1} , U _{S2} (redundant voltage supply), link and activity per port	
Network, linear, and star structure: any 100 m	
From FL SWITCH 4800E-P...	
442 mm / 44 mm / 375 mm IP20 -40 °C ... 70 °C 5 % ... 95 % (non-condensing) EN 61000-6-4 IEC 61850-3, IEEE 1613, EN 61000-6-2: 2005	

Technical data	
FL SWITCH 4808E-16FX ST-4GC	FL SWITCH 4808E-16FX SM ST-4GC
8 (RJ45 ports) 10/100 Mbps	
Ethernet (RJ45/FO combo) RJ45, shielded or SFP module (LC) Auto negotiation and autocrossing (RJ45 interface)	
16 (multi mode) 100 Mbps (Full duplex) ST BFOC	16 (single mode) 100 Mbps (Full duplex) B-FOC (ST)
8 km (fiberglass with F-G 62.5/125 0.7 dB/km F1000)	40 km (typical)
Store and forward switch, Extended Ring and IEEE redundancy, Multicast control, IGMP snooping, trunking, Port and Tagging VLANs, Port and IEEE 802.1x security, SNMP V3 and Https security, SNTP, web customization, user accounts	
LEDs: U _{S1} , U _{S2} (redundant voltage supply), link and activity per port	
Network, linear, and star structure: any 100 m	
From FL SWITCH 4800E-P...	
442 mm / 44 mm / 375 mm IP20 -40 °C ... 70 °C 5 % ... 95 % (non-condensing) EN 61000-6-4 IEC 61850-3, IEEE 1613, EN 61000-6-2: 2005	

Ordering data		
Type	Order No.	Pcs. / Pkt.
FL SWITCH 4808E-16FX LC-4GC ¹⁾	2891073	1
FL SWITCH 4808E-16FX SM LC-4GC ¹⁾	2891074	1

Ordering data		
Type	Order No.	Pcs. / Pkt.
FL SWITCH 4808E-16FX-4GC ¹⁾	2891079	1
FL SWITCH 4808E-16FX SM-4GC ¹⁾	2891080	1

Ordering data		
Type	Order No.	Pcs. / Pkt.
FL SWITCH 4808E-16FX ST-4GC	2891085	1
FL SWITCH 4808E-16FX SM ST-4GC	2891086	1

Accessories		
FL SWITCH 4800E-P1	2891075	1
FL SWITCH 4800E-P5	2891076	1
FL RED 2003E PRP	2701863	1
FL RED 2001E PRP 2LC	2701864	1

Accessories		
FL SWITCH 4800E-P1	2891075	1
FL SWITCH 4800E-P5	2891076	1
FL RED 2003E PRP	2701863	1
FL RED 2001E PRP 2LC	2701864	1

Accessories		
FL SWITCH 4800E-P1	2891075	1
FL SWITCH 4800E-P5	2891076	1
FL RED 2003E PRP	2701863	1
FL RED 2001E PRP 2LC	2701864	1

Redundancy modules

Energy networks rely on particularly high fault tolerance. The new PRP redundancy modules enable parallel redundancy without switch-over time in the event of a fault. You can therefore ensure maximum availability of your network.

Interruption-free communication

- The FL RED 2000E redundancy module is equipped with the Parallel Redundancy Protocol (PRP)
- Interoperability in high-availability networks is possible, as required in the energy sector
- The system continues to operate in the case of redundancy without switch-over time

Robust design

- Developed according to the requirements of IEC 61850-3 and IEEE 1613: complies with the high requirements for network technology in this area
- Robust to withstand voltage fluctuations due to a wide input voltage range of 18 V DC ... 58 V DC
- Robust metal housing
- Extended temperature range (-40 °C ... +70 °C)

Easy handling

- Design of a high-availability network without configuration
- LED indicators provide on-site information regarding the status of the network and redundancy
- Alarm signal contact indicates the status of the module and network

Ethernet

IEC 61850-3



3 RJ45 ports



Technical data

Ethernet interface	
Number of ports	3 (RJ45 ports)
Transmission speed	10/100 Mbps
Transmission length	100 m (per segment)
Fiber optic interface	
Interface	-
Number of ports	-
Transmission speed	-
Connection method	-
Transmission length	-
Function	
Basic functions	Ethernet redundancy module for the Parallel Redundancy Protocol
Status and diagnostics indicators	LEDs: U _{S1} , U _{S2} (redundant voltage supply), link and activity per port
Power supply	
Supply voltage	24 V DC (redundant) 48 V DC (redundant)
Residual ripple	3.6 V _{PP}
Supply voltage range	18 V DC ... 58 V DC
Typical current consumption	250 mA (at U _S = 24 V DC)
General data	
Dimensions	W / H / D 40 mm / 100 mm / 109 mm
Degree of protection	IP20
Ambient temperature (operation)	-40 °C ... 70 °C
Permissible humidity (operation)	10 % ... 95 % (non-condensing)
EMC note	Class A product, see page 527
Noise emission	EN 61000-6-4
Noise immunity	IEC 61850-3, IEEE 1613, EN 61000-6-2: 2005

Ordering data

Description	Type	Order No.	Pcs. / Pkt.
Redundancy module - 3 RJ45 ports - 1 RJ45 port, 2 LC fiber optic ports (multi mode)	FL RED 2003E PRP	2701863	1

Ethernet

IEC 61850-3



**1 RJ45 port and
2 fiber optic ports (multi mode)**



Technical data

1 (RJ45 port)
10/100 Mbps
100 m (per segment)

Ethernet FO
2 (LC multi mode)
100 Mbps (full duplex)
LC
2 km (per segment)

Ethernet redundancy module for the Parallel Redundancy Protocol

LEDs: U_{S1}, U_{S2} (redundant voltage supply), link and activity per port

24 V DC (redundant)
48 V DC (redundant)
3.6 V_{PP}
18 V DC ... 58 V DC
250 mA (at U_S = 24 V DC)

40 mm / 100 mm / 109 mm
IP20
-40 °C ... 70 °C
10 % ... 95 % (non-condensing)
Class A product, see page 527
EN 61000-6-4
IEC 61850-3, IEEE 1613, EN 61000-6-2: 2005

Ordering data

Type	Order No.	Pcs. / Pkt.
FL RED 2001E PRP 2LC	2701864	1

The compact and fanless DIN rail devices in metal housing suitable for industrial applications have an SD card slot at the front for configuration memory. The SD cards can be used for starting up or replacing the devices quickly and easily.

The devices feature an extended temperature range and contain a buffered realtime clock and trusted platform module (TPM) for secure and reliable key generation and management.

The FL MGuard RS4000 ... devices provide high-availability high-end security for industry and a remote maintenance infrastructure for the secure and reliable connection of machines and systems.

The FL MGuard RS2000 ... devices are designed for price-sensitive applications with fewer complex requirements and allow secure and reliable remote maintenance of machines and systems in the field via the Internet. In this context, they are used as industrial remote service routers with a simplified configuration.

Secure networks also with Gigabit

The new router generation for top-class security:

- Replaceable configuration memory
- Comprehensive connection options
- Flexible routing
- Intelligent stateful inspection firewall
- Secure remote services (VPN) according to IPsec standard
- Central management tool available

VPN licenses

Operation with up to 250 parallel VPN tunnels is possible with optional VPN licenses.



new

Router for standard routing



Technical data

Ethernet interface	
Number of ports	2 (RJ45 ports)
Transmission speed	10/100 Mbps
Function	
Basic functions	Router for standard routing, NAT, 1:1-NAT and port forwarding
SNMP – Simple Network Management Protocol	SNMPv1, v2, v3
Security functions	
VPN throughput	-
Number of VPN tunnels	-
Encryption methods	-
Internet Protocol Security (IPsec) mode	-
Authentication	-
Data integrity	-
Firewall data throughput	-
Firewall rules	-
Filtering	-
Protection against	IP spoofing
Routing	Standard routing, NAT, 1:1-NAT, port forwarding
Power supply	
Supply voltage	24 V DC
Typical current consumption	100 mA (at U _s = 24 V DC)
General data	
Dimensions	W / H / D 45 mm / 130 mm / 114 mm
Ambient temperature (operation)	-20 °C ... 60 °C
EMC note	Class A product, see page 527

Ordering data

Description	Type	Order No.	Pcs. / Pkt.
Router/firewall			
- Without VPN	FL MGuard RS2000 TX/TX-B	2702139	1
- With VPN			

Accessories

Parameterization memory, replaceable	SD FLASH 512MB	2988146	1
License for lifetime software update of FL MGuard field devices	FL MGuard LIC LIFETIME FW	2700184	1
License for activating CIFS Integrity Monitoring (CIM) on FL MGuard	FL MGuard LIC CIM	2701083	1
License for activating the OPC inspector function on FL MGuard	FL MGuard LIC OPC INSP	2702191	1
License for activating the firewall/router redundancy function on FL MGuard device pair	FL MGuard LIC FW RD	2701356	1

License for activating the firewall/router and VPN redundancy function on FL MGuard device pair			
Central device management software for FL MGuard devices	FL MGuard DM ... (see software)		



Router with simplified 2-click firewall and VPN



Router with intelligent firewall and VPN



Gigabit router with firewall, replaceable memory



Technical data
2 (RJ45 ports) 10/100 Mbps
Router with simplified 2-click firewall and VPN for 2 tunnels (fixed), metal housing, slot for any SD memory card, extended temperature range, high-performance firewall/VPN: up to 124 Mbps/40 Mbps
SNMPv1, v2, v3
Max. 40 Mbps (Router mode, VPN bidirectional throughput)
2 (Fixed, Ipsec (IETF standard))
DES, 3DES, AES-128, -192, -256 ESP tunnel / ESP transport X.509v3 certificates with RSA or PSK
MD5, SHA-1 Max. 124 Mbps (Router mode, default firewall rules, bidirectional throughput) Simplified 2-click stateful inspection firewall
Incoming or outgoing traffic - Standard routing, NAT, 1:1-NAT, port forwarding
24 V DC 100 mA (at U _S = 24 V DC)
45 mm / 130 mm / 114 mm -20 °C ... 60 °C Class A product, see page 527

Technical data	Technical data
FL MGuard RS4000 TX/TX	FL MGuard RS4000 TX/TX VPN
2 (RJ45 ports) 10/100 Mbps	2 (RJ45 ports) 10/100 Mbps
Router with intelligent firewall (VPN, 10 tunnels as an option, up to 250 with additional license), CIFS Integrity Monitoring (as an option), metal housing, slot for SD memory card, extended temperature range, high-performance firewall/VPN (as an option): up to 124 Mbps/40 Mbps (as an option)	Router with intelligent firewall and VPN for 10 tunnels (up to 250 supported with optional additional license), CIFS Integrity Monitoring (as an option), metal housing, slot for SD memory card, extended temperature range, high-performance firewall/VPN: up to 124 Mbps/40 Mbps
SNMPv1, v2, v3	SNMPv1, v2, v3
Max. 40 Mbps (Router mode, VPN bidirectional throughput)	Max. 40 Mbps (Router mode, VPN bidirectional throughput)
0 (up to 250 tunnels with additional license as an option)	10 (up to 250 tunnels with additional license as an option)
DES, 3DES, AES-128, -192, -256	DES, 3DES, AES-128, -192, -256
-	ESP tunnel / ESP transport
-	X.509v3 certificates with RSA or PSK
-	MD5, SHA-1
Max. 124 Mbps (Router mode, default firewall rules, bidirectional throughput) Configurable stateful inspection firewall with full scope of functions	Max. 124 Mbps (Router mode, default firewall rules, bidirectional throughput) Configurable stateful inspection firewall with full scope of functions
MAC and IP addresses, ports, protocols IP spoofing, DoS and Syn Flood Protection Standard routing, NAT, 1:1-NAT, port forwarding	MAC and IP addresses, ports, protocols IP spoofing, DoS and Syn Flood Protection Standard routing, NAT, 1:1-NAT, port forwarding
24 V DC (redundant) 100 mA (at U _S = 24 V DC)	24 V DC (redundant) 100 mA (at U _S = 24 V DC)
45 mm / 130 mm / 114 mm -20 °C ... 60 °C Class A product, see page 527	45 mm / 130 mm / 114 mm -20 °C ... 60 °C Class A product, see page 527

Technical data	Technical data
FL MGuard GT/GT	FL MGuard GT/GT VPN
2 (Combo ports) 10/100/1000 Mbps (SFP module: 100/1000 Mbps)	2 (Combo ports) 10/100/1000 Mbps (SFP module: 100/1000 Mbps)
Router with intelligent firewall and Gigabit connectivity	Router with intelligent firewall and Gigabit connectivity and VPN
SNMPv1, v2, v3	SNMPv1, v2, v3
Max. 106 Mbps (Router mode, VPN bidirectional throughput)	Max. 106 Mbps (Router mode, VPN bidirectional throughput)
0 (up to 250 tunnels with additional license as an option)	10 (up to 250 tunnels with additional license as an option)
DES, 3DES, AES-128, -192, -256	DES, 3DES, AES-128, -192, -256
-	ESP tunnel / ESP transport
-	X.509v3 certificates with RSA or PSK
-	MD5, SHA-1
Max. 417 Mbps (Router mode, default firewall rules, bidirectional throughput) Configurable stateful inspection firewall	Max. 417 Mbps (Router mode, default firewall rules, bidirectional throughput) Configurable stateful inspection firewall
MAC and IP addresses, ports, protocols IP spoofing, DoS and Syn Flood Protection Standard routing, NAT, 1:1-NAT, port forwarding	MAC and IP addresses, ports, protocols IP spoofing, DoS and Syn Flood Protection Standard routing, NAT, 1:1-NAT, port forwarding
24 V DC (redundant) 270 mA (at U _S = 24 V DC)	24 V DC (redundant) 270 mA (at U _S = 24 V DC)
128 mm / 110 mm / 69 mm -20 °C ... 60 °C	128 mm / 110 mm / 69 mm -20 °C ... 60 °C

Ordering data		
Type	Order No.	Pcs. / Pkt.
FL MGuard RS2000 TX/TX VPN	2700642	1
Accessories		
SD FLASH 512MB	2988146	1
FL MGuard LIC LIFETIME FW	2700184	1
FL MGuard LIC CIM	2701083	1
FL MGuard LIC OPC INSP	2702191	1
FL MGuard LIC FW RD	2701356	1
FL MGuard LIC FW/VPN RD	2702193	1
FL MGuard DM ... (see software)		

Ordering data		
Type	Order No.	Pcs. / Pkt.
FL MGuard RS4000 TX/TX	2700634	1
FL MGuard RS4000 TX/TX VPN	2200515	1
Accessories		
SD FLASH 512MB	2988146	1
FL MGuard LIC LIFETIME FW	2700184	1
FL MGuard LIC CIM	2701083	1
FL MGuard LIC OPC INSP	2702191	1
FL MGuard LIC FW RD	2701356	1
FL MGuard LIC FW/VPN RD	2702193	1
FL MGuard DM ... (see software)		

Ordering data		
Type	Order No.	Pcs. / Pkt.
FL MGuard GT/GT	2700197	1
FL MGuard GT/GT VPN	2700198	1
Accessories		
FL MEM PLUG	2891259	1
FL MGuard LIC LIFETIME FW	2700184	1
FL MGuard LIC CIM	2701083	1
FL MGuard LIC OPC INSP	2702191	1
FL MGuard LIC FW RD	2701356	1
FL MGuard LIC FW/VPN RD	2702193	1
FL MGuard DM ... (see software)		

Security routers for DIN rails

The compact, fanless security routers with 5 unmanaged ports or 4 managed ports and DMZ port for mutual protection of several networks are equipped with the simplified 2-click firewall or intelligent firewall with full functionality and easy configuration.

The devices have an SD card slot at the front for configuration memory. The SD cards can be used for starting up or replacing the devices quickly and easily.

The devices feature an extended temperature range and contain a buffered realtime clock and trusted platform module (TPM) for secure and reliable key generation and management.

VPN licenses

Operation with up to 250 parallel VPN tunnels is possible with optional VPN licenses.

Notes:
Central device management software, the Device Manager for FL MGuard devices can be found on page 323



new

Router with simplified 2-click firewall, VPN, and integrated switch

Ethernet interface	
Number of ports	6 (RJ45 ports)
Transmission speed	10/100 Mbps
Function	
Basic functions	
SNMP – Simple Network Management Protocol	
Security functions	
VPN throughput	Max. 42 Mbps (Router)
Number of VPN tunnels	2
Encryption methods	
Internet Protocol Security (IPsec) mode	DES, 3DES, AES-128, -192, -256
Authentication	ESP tunnel / ESP transport
Data integrity	X.509v3 certificates with RSA or PSK
Firewall data throughput	MD5, SHA-1
Firewall rules	Max. 130 Mbps (Router mode, default firewall rules, bidirectional throughput)
	Can be switched on/off
Filtering	-
Protection against routing	-
Power supply	
Supply voltage	24 V DC (redundant)
Typical current consumption	100 mA (at U _S = 24 V DC)
General data	
Dimensions	W / H / D 45 mm / 130 mm / 114 mm
Ambient temperature (operation)	-20 °C ... 60 °C

Technical data

Technical data		
Router with simplified firewall and VPN for 2 tunnels, integrated 5-port switch, metal housing, slot for SD memory card, extended temperature range, high-performance firewall/VPN: up to 124 Mbps/ 40 Mbps		
SNMPv1, v2, v3		
Max. 42 Mbps (Router)		
2		
DES, 3DES, AES-128, -192, -256		
ESP tunnel / ESP transport		
X.509v3 certificates with RSA or PSK		
MD5, SHA-1		
Max. 130 Mbps (Router mode, default firewall rules, bidirectional throughput)		
Can be switched on/off		

Description
Router/firewall
- Without VPN, 4-port Managed Switch and DMZ port
- With VPN, 5-port Unmanaged Switch

Ordering data

Type	Order No.	Pcs. / Pkt.
FL MGuard RS2005 TX VPN	2701875	1

Parameterization memory , replaceable
License for lifetime software update of FL MGuard field devices
License for activating CIFS Integrity Monitoring (CIM) on FL MGuard
License for activating the OPC inspector function on FL MGuard
License for activating the firewall/router redundancy function on FL MGuard device pair
License for activating the firewall/router and VPN redundancy function on FL MGuard device pair

Accessories

Accessories	Order No.	Pcs. / Pkt.
SD FLASH 512MB	2988146	1

Central device management software for FL MGuard devices

FL MGuard DM ... (see software)



new

Router with intelligent firewall and integrated switch



new

Router with intelligent firewall, VPN, and integrated switch

Technical data
6 (RJ45 ports) 10/100 Mbps
Router with intelligent firewall, integrated 4-port managed switch, opt. VPN (opt. for 10 tunnels, up to 250 tunnels with additional license), CIFS Integrity Monitoring (opt.), metal housing, slot for SD memory card, extended temperature range, high-performance firewall/VPN: up to 124 Mbps / 40 Mbps
SNMPv1, v2, v3
Max. 42 Mbps (Router) -
DES, 3DES, AES-128, -192, -256 - - -
Max. 130 Mbps (Router mode, default firewall rules, bidirectional throughput) Configurable stateful inspection firewall with full scope of functions
MAC and IP addresses, ports, protocols IP spoofing, DoS and Syn Flood Protection Standard routing, NAT, 1:1-NAT, port forwarding
24 V DC (redundant) 100 mA (at $U_s = 24$ V DC)
45 mm / 130 mm / 114 mm -20 °C ... 60 °C

Technical data
6 (RJ45 ports) 10/100 Mbps
Router with intelligent firewall, integrated 4-port managed switch and VPN for 10 tunnels (opt. up to 250 with additional license), CIFS Integrity Monitoring (opt.), metal housing, slot for SD memory card, extended temperature range, high-performance firewall/VPN: up to 124 Mbps / 40 Mbps
SNMPv1, v2, v3
Max. 42 Mbps (Router) 10 (up to 250 tunnels with additional license as an option)
DES, 3DES, AES-128, -192, -256 ESP tunnel / ESP transport X.509v3 certificates with RSA or PSK MD5, SHA-1 Max. 130 Mbps (Router mode, default firewall rules, bidirectional throughput) Configurable stateful inspection firewall with full scope of functions
MAC and IP addresses, ports, protocols IP spoofing, DoS and Syn Flood Protection Standard routing, NAT, 1:1-NAT, port forwarding
24 V DC (redundant) 100 mA (at $U_s = 24$ V DC)
45 mm / 130 mm / 114 mm -20 °C ... 60 °C

Ordering data		
Type	Order No.	Pcs. / Pkt.
FL MGuard RS4004 TX/DTX	2701876	1

Ordering data		
Type	Order No.	Pcs. / Pkt.
FL MGuard RS4004 TX/DTX VPN	2701877	1

Accessories		
SD FLASH 512MB	2988146	1
FL MGuard LIC LIFETIME FW	2700184	1
FL MGuard LIC CIM	2701083	1
FL MGuard LIC OPC INSP	2702191	1
FL MGuard LIC FW RD	2701356	1
FL MGuard LIC FW/VPN RD	2702193	1

Accessories		
SD FLASH 512MB	2988146	1
FL MGuard LIC LIFETIME FW	2700184	1
FL MGuard LIC CIM	2701083	1
FL MGuard LIC OPC INSP	2702191	1
FL MGuard LIC FW RD	2701356	1
FL MGuard LIC FW/VPN RD	2702193	1

FL MGuard DM ... (see software)

FL MGuard DM ... (see software)

Security routers and firewalls

Firewall/router for office-based/mobile use

The FL MGuard SMART2 features maximum possible security and performance in confined spaces.

With its robust housing and uncomplicated power supply via any USB port, the FL MGuard SMART2 is the ideal solution for the mobile protection of critical company resources.

The device is particularly suitable for the mobile and stationary protection of workstations and environments close to the production process with low requirements for industrial hardening.

It can be used as a secure firewall between office and production networks, as a remote maintenance client or as a security router for small workgroups.

Security routers without DIN rail mounting

Security is fundamental for PC-based automation. Do not leave any room for attack.

Distributed protection concepts where automation cells are protected individually provide maximum security.

In order to protect your PC reliably and easily in the network, PCI bus-based **FL MGuard PCI** cards are the ideal choice. mGuard technology features:

- Maximum security
- Optimum performance
- Central management

VPN licenses

Operation with up to 250 parallel VPN tunnels is possible with optional VPN licenses.



Router with firewall for mobile use

ERC

Ethernet interface	
Number of ports	2 (RJ45)
Transmission speed	10/100 Mbps
Function	
Basic functions	Firewall/router for office use or mobile service technicians
SNMP – Simple Network Management Protocol	SNMPv1, v2, v3
Security functions	Server or Relay Agent On external server
Dynamic Host Configuration Protocol (DHCP) support	
Remote syslog logging	
VPN throughput	Max. 42 Mbps (Router mode, VPN bidirectional throughput)
Number of VPN tunnels	0 (up to 250 tunnels with additional license as an option) 10 (up to 250 with license possible)
Encryption methods	DES, 3DES, AES-128, -192, -256
Internet Protocol Security (IPsec) mode	- ESP tunnel / ESP transport
Authentication	- X.509v3 certificates with RSA or PSK
Data integrity	- MD5, SHA-1
1:1 Network Address Translation (NAT) in the VPN	- Supported
Firewall data throughput	Max. 130 Mbps (Router mode, default firewall rules, bidirectional throughput)
Firewall rules	Configurable stateful inspection firewall
Filtering	MAC and IP addresses, ports, protocols
Protection against routing	IP spoofing, DoS and Syn Flood Protection NAT, 1:1-NAT, Port Forwarding
Power supply	
Supply voltage	5 V DC (from USB interface)
General data	
Width	77 mm
Degree of protection	IP30
Ambient temperature (operation)	0 °C ... 40 °C

Technical data	
FL MGuard SMART2	FL MGuard SMART2 VPN
	2 (RJ45)
	10/100 Mbps
	Firewall/router for office use or mobile service technicians

	SNMPv1, v2, v3
	Server or Relay Agent On external server
	Max. 42 Mbps (Router mode, VPN bidirectional throughput)
	0 (up to 250 tunnels with additional license as an option) 10 (up to 250 with license possible)
	DES, 3DES, AES-128, -192, -256
	- ESP tunnel / ESP transport
	- X.509v3 certificates with RSA or PSK
	- MD5, SHA-1
	- Supported
	Max. 130 Mbps (Router mode, default firewall rules, bidirectional throughput)
	Configurable stateful inspection firewall
	MAC and IP addresses, ports, protocols
	IP spoofing, DoS and Syn Flood Protection NAT, 1:1-NAT, Port Forwarding

Description	
Router with firewall	
- Without VPN	
- With VPN	

Ordering data		
Type	Order No.	Pcs. / Pkt.
FL MGuard SMART2	2700640	1
FL MGuard SMART2 VPN	2700639	1

Parameterization memory, replaceable
License for lifetime software update of FL MGuard field devices
License for activating CIFS Integrity Monitoring (CIM) on FL MGuard
License for activating the OPC inspector function on an FL MGuard
License for activating the firewall/router redundancy function on an FL MGuard device pair
License for activating the firewall/router and VPN redundancy function on an FL MGuard device pair

Accessories		
Type	Order No.	Pcs. / Pkt.
FL MGuard LIC LIFETIME FW	2700184	1
FL MGuard LIC CIM	2701083	1
FL MGuard LIC OPC INSP	2702191	1
FL MGuard LIC FW RD	2701356	1
FL MGuard LIC FW/VPN RD	2702193	1

Central device management software for FL MGuard devices

FL MGuard DM ... (see software)

new



Router with firewall for PCI



Router with firewall and VPN for PCI



Router with firewall and VPN for PCIe

ERC

Technical data

2 (RJ45) 10/100 Mbps
Router with intelligent firewall (VPN, 10 tunnels as an option, up to 250 with additional license), CIFS Integrity Monitoring (as an option), metal housing, slot for SD memory card, extended temperature range, high-performance firewall/VPN (as an option): up to 124 Mbps/40 Mbps (as an option)
SNMPv1, v2, v3
Server or Relay Agent On external server Max. 42 Mbps (Router mode, VPN bidirectional throughput)
0 (up to 250 tunnels with additional license as an option)
DES, 3DES, AES-128, -192, -256
-
-
Max. 130 Mbps (Router mode, default firewall rules, bidirectional throughput) Configurable stateful inspection firewall with full scope of functions
MAC and IP addresses, ports, protocols IP spoofing, DoS and Syn Flood Protection Standard routing, NAT, 1:1-NAT, port forwarding
-
-
IP00 0 °C ... 70 °C

Technical data

2 (RJ45) 10/100 Mbps
Router with intelligent firewall and VPN for 10 tunnels (up to 250 supported with optional additional license), CIFS Integrity Monitoring (as an option), metal housing, slot for SD memory card, extended temperature range, high-performance firewall/VPN: up to 124 Mbps/40 Mbps
SNMPv1, v2, v3
Server or Relay Agent On external server Max. 42 Mbps (Router)
10 (up to 250 tunnels with additional license as an option)
DES, 3DES, AES-128, -192, -256 ESP tunnel / ESP transport X.509v3 certificates with RSA or PSK
MD5, SHA-1 Supported
Max. 130 Mbps (Router mode, default firewall rules, bidirectional throughput) Configurable stateful inspection firewall with full scope of functions
MAC and IP addresses, ports, protocols IP spoofing, DoS and Syn Flood Protection Standard routing, NAT, 1:1-NAT, port forwarding
-
-
IP00 0 °C ... 70 °C

Technical data

2 (RJ45) 10/100 Mbps
Router with intelligent firewall and VPN for 10 tunnels (up to 250 supported with optional additional license), CIFS Integrity Monitoring (as an option), metal housing, slot for SD memory card, extended temperature range, high-performance firewall/VPN: up to 124 Mbps/40 Mbps
SNMPv1, v2, v3
Server or Relay Agent On external server Max. 42 Mbps (Router)
10 (up to 250 tunnels with additional license as an option)
DES, 3DES, AES-128, -192, -256 ESP tunnel / ESP transport X.509v3 certificates with RSA or PSK
MD5, SHA-1 Supported
Max. 130 Mbps (Router mode, default firewall rules, bidirectional throughput) Configurable stateful inspection firewall with full scope of functions
MAC and IP addresses, ports, protocols IP spoofing, DoS and Syn Flood Protection Standard routing, NAT, 1:1-NAT, port forwarding
-
-
IP00 0 °C ... 70 °C

Ordering data

Type	Order No.	Pcs. / Pkt.
FL MGuard PCI4000	2701274	1

Ordering data

Type	Order No.	Pcs. / Pkt.
FL MGuard PCI4000 VPN	2701275	1

Ordering data

Type	Order No.	Pcs. / Pkt.
FL MGuard PCIe4000 VPN	2701278	1

Accessories

SD FLASH 512MB	2988146	1
FL MGuard LIC LIFETIME FW	2700184	1
FL MGuard LIC CIM	2701083	1
FL MGuard LIC OPC INSP	2702191	1
FL MGuard LIC FW RD	2701356	1
FL MGuard LIC FW/VPN RD	2702193	1

Accessories

SD FLASH 512MB	2988146	1
FL MGuard LIC LIFETIME FW	2700184	1
FL MGuard LIC CIM	2701083	1
FL MGuard LIC OPC INSP	2702191	1
FL MGuard LIC FW RD	2701356	1
FL MGuard LIC FW/VPN RD	2702193	1

Accessories

SD FLASH 512MB	2988146	1
FL MGuard LIC LIFETIME FW	2700184	1
FL MGuard LIC CIM	2701083	1
FL MGuard LIC OPC INSP	2702191	1
FL MGuard LIC FW RD	2701356	1
FL MGuard LIC FW/VPN RD	2702193	1

FL MGuard DM ... (see software)

FL MGuard DM ... (see software)

FL MGuard DM ... (see software)

Network diagnostics software

FL VIEW scans the Ethernet TCP/IP (PROFINET) network and automatically detects all the devices in the network and their connections. Using various display methods, IP addresses, devices or locations can be shown in the topology with the corresponding image files.

Features:

- Status display of network connections and network devices using different colors - you can identify a faulty device or an overloaded connection immediately
- Detection of the imminent failure of network components, e.g., through detection of the increasing ping rate and its display



Network monitoring and diagnostics

Hardware requirements	
Processor	> 1 GHz
Main memory (RAM)	512 Mbyte
Hard disk memory	min. 150 Mbyte (For help and video files, an additional 650 MB is needed)
Optical drive	CD-ROM
Interfaces	Ethernet Port
Software requirements	
Operating systems	32-bit system: Windows XP SP3, 32-bit and 64-bit system: Windows 7, Windows 2003, Windows 2008 server
Basic functions	
Languages supported	
English	

Technical data		
32-bit system: Windows XP SP3, 32-bit and 64-bit system: Windows 7, Windows 2003, Windows 2008 server		
FL VIEW is a software product for detecting and monitoring industrial Ethernet TCP/IP networks with advanced features for PROFINET applications.		
FL VIEW automatically detects the topology and status of the networks and devices and transmits these in an animated realtime graphic.		
English		

Description	
Network monitoring software , for nodes in different subnetworks	
- For 64 nodes	
- For 256 nodes	
- For 512 nodes	
Network monitoring software , for 32 nodes in one subnetwork	

Ordering data		
Type	Order No.	Pcs. / Pkt.
FL VIEW 64	2701472	1
FL VIEW 256	2701473	1
FL VIEW 512	2701474	1
FL VIEW 32 LITE	2701744	1

Device Manager for FL MGuard devices

The Device Manager simplifies the management of FL MGuard security appliances.

The tool features a template mechanism that enables the user to configure and manage all FL MGuard devices centrally – from a few hundred devices to several thousand.

Features:

- Central configuration of several thousand appliances
- Template-based management tool
- Suitable for remote maintenance applications



Central management software for FL MGuard

Hardware requirements	Processor Main memory (RAM) Hard disk memory
Optical drive	
Interfaces	
Software requirements	Operating systems
Basic functions	
Languages supported	

Technical data	
> 1 GHz	512 Mbyte
4 Gbyte (free memory space (server), 500 MB free memory space (client))	CD-ROM
Ethernet Port	
MS Windows 2000 SP2 or later, Windows XP, Linux	
Central management software for up to 100 FL MGuard devices	
English	

Description	Central device management software for FL MGuard devices, for 100 devices in the field, for installation on a PC. Additional service FL MGuard PROF SERVICE2 required.
	Central device management software for FL MGuard devices, for any number of devices in the field, for installation on a PC. Additional service FL MGuard PROF SERVICE 2 required.

Ordering data		
Type	Order No.	Pcs. / Pkt.
FL MGuard DM 100	2700183	1
FL MGuard DM UNLIMITED	2981974	1

Device Manager software update, for both FL MGuard DM 100 and FL MGuard DM UNLIMITED.
Upgrade license from FL MGuard DM 100 to FL MGuard DM UNLIMITED.
Startup and induction for FL MGuard DM.

Accessories		
FL MGuard DM UPD	2700222	1
FL MGuard DM DEVICE UPGRADE	2700223	1
FL MGuard PROF SERVICE 2	2700185	1



Much more than products, we also offer you support whenever you need it.

We offer on-demand professional support, from consultation, network analysis, and design to configuration support and startup. We not only support you over the phone or by e-mail, but also directly on site, if you so desire. Contact us for more information.

We support you in the design and planning of your network.

We will develop custom solutions for you that are tailored to your specific requirements. Whether you need failsafe network structures, concepts for protecting or remotely maintaining your machinery or high-performance wireless networks, we will find the right solution for you.

FL START-UP SUPPORT

Order No. 2701426

Description:

- Startup of network components from Phoenix Contact
- Support regarding analysis, consultation/planning or configuration/startup together with a responsible person employed by the initiator

Services offered in the following areas:

“Analysis”

- Assessment of existing network environment
- Analysis of network in relation to requirements
- Measurement of wireless field
- Measurement of data throughput
- Determining frequency band use
- Checking the network security concept

“Planning/consultation”

- Advice on the selection of wireless technology and antenna technology
- Planning/creation and development of a network security concept
- Planning/creation and development of a redundancy concept
- Planning/creation and development of a diagnostics concept
- Advice on the selection of technology and corresponding components
- Planning/creation and development of an Ethernet network including documentation

“Configuration/startup”

- Support with configuration/startup of Ethernet networks
- Support with configuration/startup of WLAN/Bluetooth connections
- Support with configuration/startup of VPN connections

We will turn you into an automation network specialist - if you so desire.

Do you want to gain a better insight into network technology for yourself or your staff?

We offer individual and practical training courses that are tailor-made to suit your requirements and needs.

FL TRAINING

Order No. 2701427

Description:

- Training with network components from Phoenix Contact covering network standards, Ethernet security or wireless

“Ethernet security” training

- The design and implementation of sophisticated Ethernet security and remote service solutions.
- Put your theoretical knowledge to the test on an industrial Ethernet network with components from Phoenix Contact

“Wireless” training

- Learn how important wireless technology is and how it is used in automation
- Detailed explanation of the basics of wireless technology such as wireless LAN (WLAN) and Bluetooth
- Creation of wireless networks in practical exercises



Our specialists are also on hand to offer practical support on site.

We offer support during the configuration and startup phases. We measure and assess the performance, availability, and security of your network. We also show you how it can be optimized.

What's more, if your network is not working according to your expectations, we will eliminate any faults.

**FL MAINTENANCE SUPPORT
Order No. 2701424**

Description:

- Troubleshooting in an Ethernet communication network with components from Phoenix Contact together with a responsible person employed by the initiator

Services offered:

- Support with troubleshooting
- Support with the hardware check
- Network analysis
- Configuration check
- Provision of high-quality measuring instruments
- Service report with complete documentation

Services for Functional Safety can be found on page 94.

Services for automation can be found on page 488.

PROFINET proxies

Gateways and proxies from Phoenix Contact are the intelligent solution for integrating networks into other networks.

Your advantages:

- 1:1 integration of networks or segments, thanks to proxy technology
- Easy system modernization with transparent communication over multiple bus systems
- Versatile diagnostics: thanks to topology detection and manufacturer-independent diagnostic concepts
- Fast device replacement with optional CF card as parameterization memory

Proxy for INTERBUS

Do you want to integrate an INTERBUS application into a PROFINET network? Then the FL NP PND-4TX IB is the ideal solution. Simply parameterize the device using your corresponding programming tool. Use the integrated switch in the control cabinet as an uplink to the higher-level control system or in the field for series connection.

Proxy for PROFIBUS

Integrate controllers, I/O stations, and other automation devices seamlessly into a PROFIBUS network. Each PROFIBUS device can be configured and diagnosed directly using the FL NP PND-4TX PB. I/O signals of PROFIBUS devices are linked directly to program variables from the application. The PROFIBUS proxy is operated exclusively using PC Worx.

Additional features:

- Data exchange, diagnostics, and parameterization are via the PROFINET protocol
- They can be integrated and parameterized in any controller using the PROFINET functionality
- LLDP support for topology detection
- PROFINET update rates ≥ 1 ms



PROFINET INTERBUS proxy

PROFIBUS

PROFINET	
Specification	PROFINET RT, spec. 3.2
Conformance class	B
Update rate	min. 1 ms
Software	Diagnostics software: DIAG+, version 2.0 or higher Configuration software: using the GSDML file or PC Worx version 5.0 or higher
Ethernet	
Connection method	RJ45 socket
Transmission speed	10/100 Mbps
INTERBUS	
Interface	INTERBUS (Master)
Connection method	9-pos. D-SUB socket
Number	1
Number of I/O nodes	8192
Number of devices with parameter channel	Max. 126 (512 words)
Transmission speed	500 kBaud/2 Mbaud, can be selected
PROFIBUS	
Interface	-
Connection method	-
Number	-
Transmission speed	-
Number of supported devices	Max. 512 (Depending on the control class and data direction)
Power supply	
Supply voltage	24 V DC
Supply voltage range	18.5 V DC ... 30.2 V DC
Typical current consumption	typ. 350 mA
General data	
Dimensions	W / H / D 128 mm / 95 mm / 69 mm
Ambient temperature (operation)	-25 °C ... 60 °C
Ambient temperature (storage/transport)	-25 °C ... 70 °C

Technical data

PROFINET	
Specification	PROFINET RT, spec. 3.2
Conformance class	B
Update rate	min. 1 ms
Software	Diagnostics software: DIAG+, version 2.0 or higher Configuration software: using the GSDML file or PC Worx version 5.0 or higher
Ethernet	
Connection method	RJ45 socket
Transmission speed	10/100 Mbps
INTERBUS	
Interface	INTERBUS (Master)
Connection method	9-pos. D-SUB socket
Number	1
Number of I/O nodes	8192
Number of devices with parameter channel	Max. 126 (512 words)
Transmission speed	500 kBaud/2 Mbaud, can be selected
PROFIBUS	
Interface	-
Connection method	-
Number	-
Transmission speed	-
Number of supported devices	Max. 512 (Depending on the control class and data direction)
Power supply	
Supply voltage	24 V DC
Supply voltage range	18.5 V DC ... 30.2 V DC
Typical current consumption	typ. 350 mA
General data	
Dimensions	W / H / D 128 mm / 95 mm / 69 mm
Ambient temperature (operation)	-25 °C ... 60 °C
Ambient temperature (storage/transport)	-25 °C ... 70 °C

Description	Proxy for PROFINET - INTERBUS - INTERBUS FO - PROFIBUS
-------------	---

Ordering data

Type	Order No.	Pcs. / Pkt.
FL NP PND-4TX IB	2985974	1

Parameterization memory

Accessories

CF FLASH 256MB	2988780	1
----------------	---------	---



PROFINET INTERBUS fiber optic proxy



PROFINET PROFIBUS proxy for PC Worx control systems



Technical data
PROFINET RT, spec. 3.2
B
min. 1 ms
Diagnostics software: DIAG+, version 2.0 or higher Configuration software: using the GSDML file or PC Worx version 5.0 or higher
RJ45 socket 10/100 Mbps
INTERBUS (Master)
F-SMA connector
1
8192
Max. 126 (512 words)
500 kBaud/2 Mbaud, can be selected
-
-
-
-
Max. 512 (Depending on the control class and data direction)
24 V DC
18.5 V DC ... 30.2 V DC
typ. 350 mA
128 mm / 95 mm / 69 mm
-25 °C ... 60 °C
-25 °C ... 70 °C

Technical data
PROFINET-IO RT, Spec. 2.1
B
min. 1 ms
Diagnostics software: DIAG+, version 2.0 or higher Configuration software PC Worx starting from Version 5.20, Service Pack 3
RJ45 socket 10/100 Mbps
-
-
-
-
-
PROFIBUS DP V0/V1 class 2 master
9-pos. D-SUB socket
1
to 12 Mbps
Max. 125
24 V DC
18.5 V DC ... 30.2 V DC
350 mA
128 mm / 95 mm / 69 mm
-25 °C ... 55 °C
-25 °C ... 70 °C

Ordering data		
Type	Order No.	Pcs. / Pkt.
FL NP PND-4TX IB-LK	2985929	1

Ordering data		
Type	Order No.	Pcs. / Pkt.
FL NP PND-4TX PB	2985071	1

Accessories		
CF FLASH 256MB	Order No.	Pcs. / Pkt.
CF FLASH 256MB	2988780	1

Accessories		
CF FLASH 256MB	Order No.	Pcs. / Pkt.
CF FLASH 256MB	2988780	1

Accessories

The reliability of networks is becoming more and more important and is a decisive factor for the future of entire companies. Independent studies show that more than 70% of network errors and crashes are due to faulty cabling infrastructure and manipulation of the connecting cables.

With the new accessories for Factoryline patch cables, the various safety requirements for automation are comprehensively met.



Dust protection for SFN switches and FL MC 1000 and 2000 media converters



Security lock for SFN switches and FL MC 1000 and 2000 media converters

Description	Ordering data			Ordering data		
	Type	Order No.	Pcs. / Pkt.	Type	Order No.	Pcs. / Pkt.
Dust protection with color marking , for SFN switch and angled patch connector - Black - Blue - Brown - Yellow - Gray - Green - Red - Violet - White	FL DUST CVR BK FL DUST CVR BU FL DUST CVR BN FL DUST CVR YE FL DUST CVR GY FL DUST CVR GN FL DUST CVR RD FL DUST CVR VT FL DUST CVR WH	2891107 2891204 2891301 2891408 2891505 2891602 2891709 2891806 2891903	10 10 10 10 10 10 10 10 10			
Security frame for SFN switch and patch fields - Green - Red - White				FL PLUG GUARD GN FL PLUG GUARD RD FL PLUG GUARD WH	2891615 2891712 2891819	20 20 20
Locking element for security frame FL PLUG GUARD... - Locking element - Key				FL PORT GUARD FL PLUG GUARD KEY	2891220 2891327	20 1
Color marking for FL CAT... Patch... - Black - Blue - Brown - Yellow - Gray - Green - Red - Violet						
Security element for FL CAT ...patch... - Security element - Security element, lockable - Key						
Dust protection cap for RJ45 socket						





Color coding for RJ45 FL patch cables



Security element for RJ45 FL patch cables



Dust protection for RJ45 sockets

Ordering data			Ordering data			Ordering data		
Type	Order No.	Pcs. / Pkt.	Type	Order No.	Pcs. / Pkt.	Type	Order No.	Pcs. / Pkt.
FL PATCH CCODE BK	2891194	20						
FL PATCH CCODE BU	2891291	20						
FL PATCH CCODE BN	2891495	20						
FL PATCH CCODE YE	2891592	20						
FL PATCH CCODE GY	2891699	20						
FL PATCH CCODE GN	2891796	20						
FL PATCH CCODE RD	2891893	20						
FL PATCH CCODE VT	2891990	20						
			FL PATCH SAFE CLIP	2891246	20			
			FL PATCH GUARD	2891424	20			
			FL PATCH GUARD KEY	2891521	1			
						FL RJ45 PROTECT CAP	2832991	10





Industrial communication technology

The increasing degree of automation in modern systems and machinery is placing ever growing demands on the performance capabilities of the communication networks used.

The “main arteries” of these networks consist of various types of serial data link, which are neither inter-compatible nor capable of satisfying the increasingly stringent requirements with regard to immunity to interference, range, and speed. Even in harsh industrial environments, our products ensure interference-free and high-performance data transmission.

Copper transmission

High-performance isolators, repeaters, and converters are available for all leading networks. The devices excel thanks to their high insulation voltages between the interfaces, which effectively prevent faults and compensating currents.

Fiber optics transmission

Fiber optic data transmission has become the norm, particularly in critical applications with very high requirements regarding availability. Whether immunity to interference, high performance, electrical isolation or network expansion, the use of fiber optic technology is unavoidable.

Remote communication

Global networking of machines and systems. Alarm generation, remote maintenance, and continual data acquisition. From classic analog modems to fast mobile phone routers: the right system for every application.

Wireless data communication

Modern wireless systems are a flexible, extendable, and low-cost alternative. Depending on the distance to be covered and the signals to be transmitted, various wireless technologies are available such as Trusted Wireless, Bluetooth or WLAN.

Product overview	332
<hr/>	
Copper transmission	
RS-485 repeaters for PROFIBUS, Modbus, and company-specific 2-wire systems	334
Active PROFIBUS termination	335
Repeaters for ControlNet™	336
Repeaters, segment couplers, and bridge for DeviceNet™	337
Isolators and converters for RS-232, TTY (CL)	338
Converters for RS-422, RS-485 4-wire bus systems	341
<hr/>	
Fiber optics transmission	
FO converters:	
- For PROFIBUS	343
- For ControlNet™	345
- For DeviceNet™, and CANopen®	347
- For RS-485 2-wire bus systems	349
- For INTERBUS, RS-422, and RS-485 4-wire bus systems	351
- For RS-232	353
Fiber optic cables, tools, and measuring devices	354
<hr/>	
Ethernet networks	
Media converters for fiber optics	380
COM server for serial interfaces	385
Electrical Ethernet isolators, patch panels, Ethernet cables	386
<hr/>	
Remote communication	
Mobile communication (SMS, e-mail)	392
Mobile phone network (GSM/GPRS or EDGE router)	395
Mobile phone network (UMTS/HSPA router)	397
Public network (DSL broadband router)	399
Public network (analog modems)	401
Private network (extender)	403
Protocol converter, antennas, and surge protection	404
<hr/>	
Fast connection technology	
PROFIBUS cables and fast connection tools	407
D-SUB fast connection, M12	408
D-SUB fast connection for PROFIBUS	410
D-SUB fast connection for CANopen® and SafetyBUS p	412
D-SUB fast connection for Modbus, INTERBUS, RS-232, RS-422, RS-485	414
USB and RS-232 cables, RS-485 connection distributors	416
<hr/>	
Wireless data communication	491

Product overview

Copper transmission



Repeaters for electrical isolation and increasing the range

Page 334



Termination resistor for active bus termination

Page 335



RS-232/TTY interface converter

Page 338



Device couplers for FOUNDATION Fieldbus and PROFIBUS PA

Page 425

Fiber optics transmission



FO converters for INTERBUS

Page 351



FO converters for RS-232

Page 353



FO accessories – FO cables, connectors, and tools

Page 354



FO accessories – FO patch cables

Page 376

Ethernet networks



Passive mini patch panels with various connection options

Page 388



Ethernet accessories – CAT 5e SF/UTP cables, RJ45 connectors, crimping pliers, patch cables

Page 390



Switches, interface modules, hubs, Power over Ethernet modules

Page 273



Secure networks – routers with firewall for control cabinet and mobile use, PCI

Page 316

Remote communication



Public network – analog modem for dial-up and permanent line operation

Page 401



Private network – extenders (SHDSL) for in-house cables

Page 403



Protocol converters

Page 404

Wireless



Radioline wireless modules, Bluetooth, WirelessHART, and accessories

Page 491

Fiber optics transmission



FO converters for PROFIBUS
Page 343



FO converters for ControlNet™
Page 345



FO converters for DeviceNet™ and
CANopen®
Page 347



FO converters for RS-485 2-wire bus
systems
Page 349

Ethernet networks



Universal media converters for conversion to
fiber optics
Page 380



Media converters for realtime protocols and
IEC 61850 environments
Page 382



COM server – device servers for converting
serial interfaces
Page 385



Isolator for electrical isolation
Page 386

Remote communication



Mobile communication – remote signaling
and remote control system
Page 392



Mobile communication – mobile phone
routers with firewall and VPN
Page 394



Mobile communication – MGUARD security
routers
Page 397



Public network – DSL broadband
router/modem with firewall, VPN,
and serial device server
Page 399

Fast connection technology



Type A Fast Connect PROFIBUS cable and
quick stripping tool
Page 407



M12 D-SUB fast connection for PROFIBUS
and CANopen®
Page 408



D-SUB fast connection for PROFIBUS and
CANopen®
Page 410



D-SUB fast connection for Modbus,
INTERBUS, RS-232, RS-422, RS-485
Page 414

Copper transmission

RS-485 repeaters for PROFIBUS, Modbus, and company-specific 2-wire systems

The performance and availability of bus systems can be significantly increased by using repeaters. In addition to electrical isolation, bus segmentation with repeaters makes it possible to multiply the permissible coverage of the network and to extend the number of devices.

The **PSI-REP-PROFIBUS/12MB** modular repeater has been specially developed for the requirements of PROFIBUS systems.

- Bit retiming for unrestricted cascading of devices
- Filtering of faulty telegrams based on start delimiter detection
- Routing of supply voltage and data signals through DIN rail connectors

As a modular repeater, the **PSI-REP-RS485W2** can be used in RS-485 2-wire bus systems.

- Bit retiming for unrestricted cascading of devices
- Routing of supply voltage and data signals through DIN rail connectors

The **PSM-ME-RS485/RS485-P** compact repeater is designed for universal use in RS-485 2-wire bus systems.

- Transmission speeds of up to 1.5 Mbps
- Space-saving slim 22.5 mm device
- Shipbuilding approval according to DNV

The **PSI-TERMINATOR-PB** ensures interference-free communication in PROFIBUS and RS-485 networks.

- Permanently active termination of the bus line, particularly in applications involving alternating bus devices
- Fixed programming interface on the network

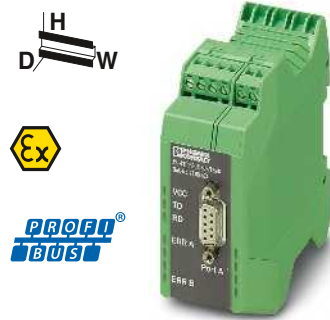

Repeater for PROFIBUS, 4-way isolation, supports modular expansion



Supply	
Supply voltage	-
Supply voltage range	18 V DC ... 30 V DC (via plug-in COMBICON screw terminal block)
Nominal current consumption	
RS-485 interface	90 mA (24 V DC) PROFIBUS according to IEC 61158, RS-485 2-conductor
Data format/coding	
Data direction switching	UART (11 bit, NRZ) Automatic control, min. station response time 2 bits
Termination resistor	
Termination resistor	External
Transmission speed	
Transmission speed	9,6/19,2/45,45/93,75/187,5/500/1500/3000/6000/12000 kbps (can be set manually and automatically)
Transmission length	
Transmission length	≤ 1200 m (Depends on transmission speed and cable type)
Connection method	
Connection method	D-SUB-9 socket
General data	
bit distortion, input	Max. ± 35 %
bit distortion, output	< 6.25 %
bit delay	1 bit (Direct mode)
Alarm output	30 V DC (1 A) / 65 V DC (0.46 A) / 150 V AC (0.46 A)
Test voltage	
Ambient temperature range	1.5 kV _{rms} (50 Hz, 1 min.) -20 °C ... 60 °C
Electrical isolation	VCC // TBUS // PROFIBUS (A) // PROFIBUS (B)
Dimensions	35 mm / 99 mm / 105 mm
EMC note	Class A product, see page 527
Conformance / approvals	
ATEX	Ex II 3 G Ex nA nC IIC T4 Gc X
UL, USA / Canada	cULus listed UL 508 Class I, Zone 2, AEx nA IIC T6 Class I, Zone 2, Ex nA IIC T6 Gc X Class I, Div. 2, Groups A, B, C, D

Technical data		
-		
18 V DC ... 30 V DC (via plug-in COMBICON screw terminal block)		
90 mA (24 V DC) PROFIBUS according to IEC 61158, RS-485 2-conductor		
UART (11 bit, NRZ) Automatic control, min. station response time 2 bits		
External		
9,6/19,2/45,45/93,75/187,5/500/1500/3000/6000/12000 kbps (can be set manually and automatically)		
≤ 1200 m (Depends on transmission speed and cable type)		
D-SUB-9 socket		
Max. ± 35 %		
< 6.25 %		
1 bit (Direct mode)		
30 V DC (1 A) / 65 V DC (0.46 A) / 150 V AC (0.46 A)		
1.5 kV _{rms} (50 Hz, 1 min.) -20 °C ... 60 °C		
VCC // TBUS // PROFIBUS (A) // PROFIBUS (B)		
35 mm / 99 mm / 105 mm		
Class A product, see page 527		
Ex II 3 G Ex nA nC IIC T4 Gc X cULus listed UL 508 Class I, Zone 2, AEx nA IIC T6 Class I, Zone 2, Ex nA IIC T6 Gc X Class I, Div. 2, Groups A, B, C, D		

Description	
Repeater, for electrical isolation and increased range	
Active termination resistor , bus termination can be activated, programming interface	
DIN rail connector (optional), for routing through the supply voltage and data signal, two pieces are required per device	
System power supply , primary-switched	

Ordering data		
Type	Order No.	Pcs. / Pkt.
PSI-REP-PROFIBUS/12MB	2708863	1
Accessories		
ME 17,5 TBUS 1,5/ 5-ST-3,81 GN	2709561	10
MINI-SYS-PS-100-240AC/24DC/1.5	2866983	1



Repeater for RS-485 2-wire systems, 4-way isolation, supports modular expansion



RS-485



Basic repeater for RS-485 2-wire systems, 3-way isolation



Active bus termination for PROFIBUS and RS-485 2-wire systems



Technical data
-
18 V DC ... 30 V DC (via plug-in COMBICON screw terminal block)
75 mA (24 V DC)
RS-485 interface, according to EIA/TIA-485, DIN 66259-4/RS-485 2-wire UART (11/10 bit switchable; NRZ)
Automatic control, min. station response time 2 bits
390 Ω (can be connected to port A and B) / 150 Ω / 390 Ω
4,8/9,6/19,2/38,4/57,6/75/93,75/115,2/136/187,5/375/500 kbps (can be set manually)
≤ 1200 m (depends on transmission speed, bus system and cable type)
Plug-in screw connection
Max. ± 35 %
< 6.25 %
< 1 bit
-
1.5 kV _{rms} (50 Hz, 1 min.)
-20 °C ... 60 °C
VCC // TBUS // RS-485 (A) // RS-485 (B)
35 mm / 99 mm / 105 mm
Class A product, see page 527
Ex II 3 G Ex nA IIC T4 Gc X
508 recognized
Class I, Zone 2, AEx nA IIC T6
Class I, Zone 2, Ex nA IIC T6 Gc X
Class I, Div. 2, Groups A, B, C, D

Technical data
-
18 V AC/DC ... 30 V AC/DC (via plug-in COMBICON screw terminal block)
90 mA (24 V DC)
RS-485 interface, according to EIA/TIA-485, DIN 66259-4/RS-485 2-wire UART (11/10 bit switchable; NRZ)
Automatic control, min. station response time 1 bits
390 Ω / 180 Ω / 390 Ω (can be connected)
4,8/ 9,6/ 19,2/ 38,4/ 57,6/ 75/ 93,75/ 115,2/ 136/ 187,5/ 375/ 500/ 1500 kbps
≤ 1200 m (depends on transmission speed, bus system and cable type)
Plug-in screw connection
Max. ± 35 %
< 3.6 %
< 200 ns
-
1.5 kV _{rms} (50 Hz, 1 min.)
-40 °C ... 70 °C
-
22.5 mm / 99 mm / 114.5 mm
Class A product, see page 527
-
-

Technical data
24 V DC (via plug-in COMBICON screw terminal block)
19.2 V DC ... 28.8 V DC (via plug-in COMBICON screw terminal block)
45 mA (24 V DC)
PROFIBUS according to IEC 61158, RS-485 2-conductor
-
-
390 Ω / 220 Ω / 390 Ω (can be connected)
≤ 12 Mbps
≤ 1200 m (depends on transmission speed and cable type)
D-SUB 9, COMBICON
-
-
-
1.5 kV _{rms} (50 Hz, 1 min.)
-20 °C ... 65 °C
DIN EN 50178 (RS-485 // VCC)
22.5 mm / 99 mm / 56 mm
Class A product, see page 527
Ex II 3 G Ex nA IIC T4 Gc X
508 listed
Class I, Div. 2, Groups A, B, C, D

Ordering data		
Type	Order No.	Pcs. / Pkt.
PSI-REP-RS485W2	2313096	1
Accessories		
ME 17,5 TBUS 1,5/ 5-ST-3,81 GN	2709561	10
MINI-SYS-PS-100-240AC/24DC/1.5	2866983	1

Ordering data		
Type	Order No.	Pcs. / Pkt.
PSM-ME-RS485/RS485-P	2744429	1
Accessories		

Ordering data		
Type	Order No.	Pcs. / Pkt.
PSI-TERMINATOR-PB	2313944	1
Accessories		

Copper transmission

Repeaters, segment coupler, and bridge

The infrastructure components for CAN-based transmission systems (DeviceNet™ and CANopen®) can be used to implement interference-free and high-performance networks. Important requirements such as segmentation, electrical isolation, and expansion of the network coverage can now be implemented as easily as almost any network structure.

The **PSI-REP-CNET** and **PSI-REP-DNET CAN** modular repeaters connect two ControlNet™ or CAN segments with the same data rate.

The **PSI-SC-DNET CAN** modular segment coupler connects two CAN segments with different data rates. The segment coupler is configured using the PSI-CONF software that is supplied as standard so that only data telegrams with specific addresses (identifiers) are transmitted to the other segment.

The **PSI-BRIDGE-DNET CAN** modular bridge connects two CAN segments via different infrastructure solutions. An RS-422 interface is integrated as standard for connecting the desired infrastructure. In the simplest case, two CAN segments that are physically separated are directly connected via the RS-422 interface over a maximum distance of 1200 m.

Additional components can be used to also convert the RS-422 interface to Ethernet, wireless or SHDSL. The bridge is configured using the PSI-CONF software that is supplied as standard so that only data telegrams with specific addresses (identifiers) are transmitted via the RS-422 interface.

The following components can be used to convert the RS-422 interface:

- **FL COMSERVER...:**
conversion to Ethernet, page 385.
- **PSI-MODEM-SHDSL...:**
conversion to SHDSL, distances of up to 20 km, page 403.
- **PSI-WL...:**
conversion to Bluetooth for wireless paths of up to 150 m, page 508.

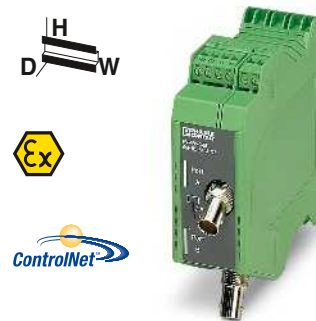

Repeater for ControlNet



Supply	
Supply voltage	24 V DC
Nominal current consumption	38 mA (24 V DC)
RS-422 interface	
Termination resistor	-
Transmission speed	-
Transmission length	-
Connection method	-
ControlNet interface	ControlNet interface, according to EN 50170
Transmission speed	5 Mbps
Transmission length	≤ 1000 m
Connection method	BNC 75 Ω
CAN interface	
Termination resistor	-
Transmission speed	-
Transmission length	-
Connection method	-
General data	
Bit delay	< 3 Bit
Test voltage	1.5 kV _{rms} (50 Hz, 1 min.)
Ambient temperature range	-20 °C ... 60 °C
Electrical isolation	VCC // CNET // CNET
Dimensions	35 mm / 108 mm / 117 mm
EMC note	Class A product, see page 527
Conformance / approvals	
ATEX	Ex II 3 G Ex nA IIC T4 Gc X
UL, USA / Canada	508 listed

Technical data		
Supply		
Supply voltage	24 V DC	
Nominal current consumption	38 mA (24 V DC)	
RS-422 interface		
Termination resistor	-	
Transmission speed	-	
Transmission length	-	
Connection method	-	
ControlNet interface	ControlNet interface, according to EN 50170	
Transmission speed	5 Mbps	
Transmission length	≤ 1000 m	
Connection method	BNC 75 Ω	
CAN interface		
Termination resistor	-	
Transmission speed	-	
Transmission length	-	
Connection method	-	
General data		
Bit delay	< 3 Bit	
Test voltage	1.5 kV _{rms} (50 Hz, 1 min.)	
Ambient temperature range	-20 °C ... 60 °C	
Electrical isolation	VCC // CNET // CNET	
Dimensions	35 mm / 108 mm / 117 mm	
EMC note	Class A product, see page 527	
Conformance / approvals		
ATEX	Ex II 3 G Ex nA IIC T4 Gc X	
UL, USA / Canada	508 listed	

Description
Modular repeater for electrical isolation and increasing the range
Modular segment coupler for connecting slow network segments
Modular bridge that allows the use of alternative transmission technologies

Ordering data		
Type	Order No.	Pcs. / Pkt.
PSI-REP-CNET	2313737	1

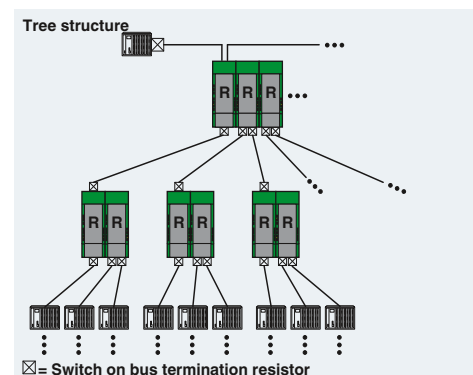



DeviceNet™

CANopen™



Repeater
for DeviceNet™ and CANopen®



DeviceNet™

CANopen™



Segment coupler
for DeviceNet™ and CANopen®



DeviceNet™

CANopen™



Bridge
for DeviceNet™ and CANopen®



Technical data
24 V DC 55 mA (24 V DC)
- - - -
CAN interface, according to ISO/IS 11898 for DeviceNet, CAN, CANopen 124 Ω (integrated and ready to be switched) ≤ 1 Mbps (configurable via DIP switches) ≤ 5000 m (dependent on the data rate and the protocol used)
COMBICON plug-in screw terminal block
≤ 1 bit (FAST) 1.5 kV _{rms} (50 Hz, 1 min.) -20 °C ... 60 °C VCC // CAN A // CAN B 35 mm / 111 mm / 121 mm Class A product, see page 527
Ex II 3 G Ex nA IIC T4 Gc X 508 listed

Technical data
24 V DC 55 mA (24 V DC)
- - - -
CAN interface, according to ISO/IS 11898 for DeviceNet, CAN, CANopen 124 Ω (integrated and ready to be switched) ≤ 1000 kbps ≤ 5000 m (dependent on the data rate and the protocol used)
COMBICON plug-in screw terminal block
≤ 108 Bit 1.5 kV _{rms} (50 Hz, 1 min.) -20 °C ... 60 °C VCC // CAN A // CAN B 35 mm / 111 mm / 121 mm Class A product, see page 527
Ex II 3 G Ex nA IIC T4 Gc X 508 listed

Technical data
24 V DC 55 mA (24 V DC) RS-422 interface according to ITU-T V.11, EIA/TIA-422, DIN 66348-1 150 Ω ≤ 500 kbps ≤ 1200 m (Dependent on the data rate) COMBICON plug-in screw terminal block
- - -
CAN interface, according to ISO/IS 11898 for DeviceNet, CAN, CANopen 124 Ω (integrated and ready to be switched) ≤ 1000 kbps ≤ 5000 m (dependent on the data rate and the protocol used)
COMBICON plug-in screw terminal block
- 1.5 kV _{rms} (50 Hz, 1 min.) -20 °C ... 60 °C VCC // CAN // RS-422 35 mm / 111 mm / 121 mm Class A product, see page 527
Ex II 3 G Ex nA IIC T4 Gc X 508 listed

Ordering data		
Type	Order No.	Pcs. / Pkt.
PSI-REP-DNET CAN	2313423	1

Ordering data		
Type	Order No.	Pcs. / Pkt.
PSI-SC-DNET CAN	2313449	1

Ordering data		
Type	Order No.	Pcs. / Pkt.
PSI-BRIDGE-DNET CAN	2313533	1

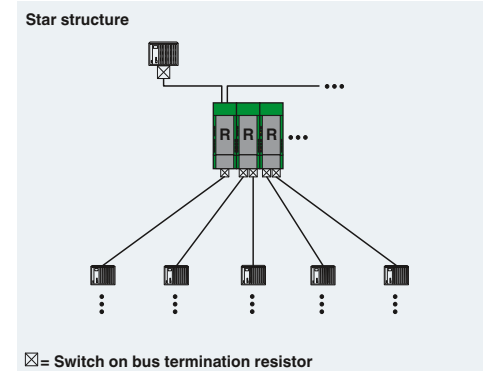
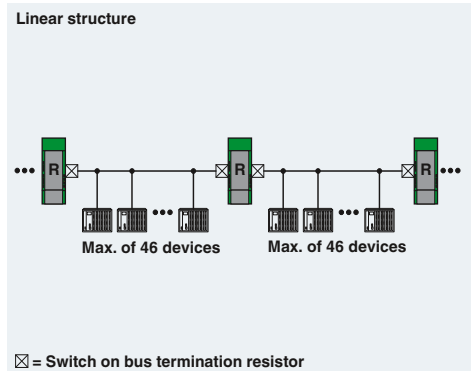
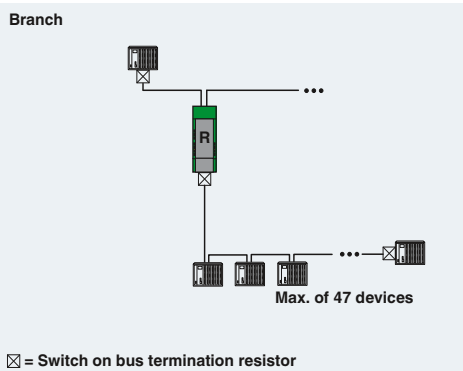

Copper transmission

Interface isolator

RS-232 / RS-232 interface isolator

The RS-232 interface is an asymmetric voltage interface (common signal ground for all signals). As well as having a very low signal power, the signal ground is connected to ground potential. This results in very little immunity to interference and a maximum range of 15 m.

A considerably higher level of immunity to interference can be achieved in industrial applications by using RS-232 isolator modules. The high-quality 3-way isolation results in an electrically isolated and interference-proof RS-232 interface. This decoupling also protects the expensive terminal devices against damage.

Features:

- High-quality 3-way isolation up to 2 kV (VCC // RS-232 // RS-232)
- Max. transmission rate of up to 115.2 kbps
- 24 V DC or AC power supply suitable for control cabinet
- Mounting on standard EN DIN rails
- Integrated surge protection with transient discharge to the DIN rail
- In the case of variable cable lengths, the RS-232 connection on the field side can be established conveniently using plug-in screw terminal blocks
- Transmission of TxD/RxD data channels and RTS/CTS control lines
- Active data transmission indicated by separate data indicators for the transmit and receive channels

Application:

- Higher level of immunity to interference for industrial conditions
- Compensating currents avoided through electrical isolation
- Protection of expensive terminal devices through decoupling
- Optimum protection of both interface sides thanks to two RS-232/RS-232 interface isolators

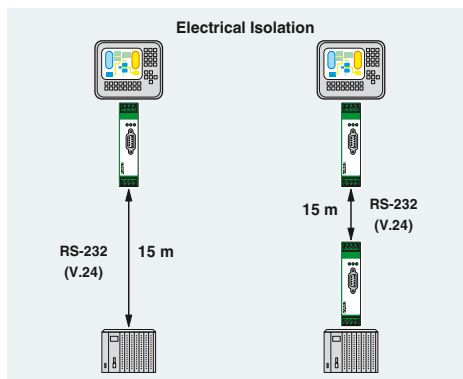

RS-232



RS-232 interface isolator



Supply	
Supply voltage	24 V AC/DC ±20 %
Supply voltage range	19.2 V AC/DC ... 28.8 V AC/DC
Nominal current consumption	40 mA (24 V DC)
RS-232 Interface	
Transmission speed	RS-232 interface according to ITU-T V.28, EIA/TIA-232, DIN 66259-1
Transmission length	115.2 kbps
Connection method	15 m (twisted pair)
General data	
Bit distortion	< 5 %
Bit delay	< 3 μs
Test voltage	2 kV
Ambient temperature range	0 °C ... 55 °C
Housing material	PA
Transmission channels	4 (2/2), RxD, TxD, RTS, CTS; full duplex
Electrical isolation	VCC // RS-232 (A) // RS-232 (B)
Dimensions	22.5 mm / 99 mm / 118.6 mm
EMC note	Class A product, see page 527
Conformance / approvals	
UL, USA / Canada	508 recognized Class I, Div. 2, Groups A, B, C, D

Technical data

24 V AC/DC ±20 %
19.2 V AC/DC ... 28.8 V AC/DC
40 mA (24 V DC)
RS-232 interface according to ITU-T V.28, EIA/TIA-232, DIN 66259-1
115.2 kbps
15 m (twisted pair)
D-SUB-9 plug
Plug-in screw connection

< 5 %
< 3 μs
2 kV
0 °C ... 55 °C
PA
4 (2/2), RxD, TxD, RTS, CTS; full duplex
VCC // RS-232 (A) // RS-232 (B)
22.5 mm / 99 mm / 118.6 mm
Class A product, see page 527

508 recognized
Class I, Div. 2, Groups A, B, C, D

Description
Interface isolator , for electrical isolation of RS-232 interfaces, four channels, rail-mountable

Ordering data

Type	Order No.	Pcs. / Pkt.
PSM-ME-RS232/RS232-P	2744461	1

RS-232-D-SUB cable , length: 2 m
- 9-pos. socket on 25-pos. socket
- 9-pos. socket on 9-pos. socket

Accessories

Type	Order No.	Pcs. / Pkt.
PSM-KA 9 SUB 25/BB/2METER	2761059	1
PSM-KA9SUB9/BB/2METER	2799474	1

Interface converters

RS-232 / TTY interface converter

This converter converts a RS-232 interface into a 20 mA TTY current loop interface bidirectionally.

The interference immune TTY signal allows problem-free data transmission over distances of up to 1000 m using a twisted-pair and shielded 4-wire cable.

Features:

- Conversion of RS-232 TxD/RxD full duplex data signals into the TTY current loop standard
- Semi-active, active or passive TTY operating mode, depending on pin assignment
- Transmission speed of up to 19.2 kbps
- Transmission distances of up to 1000 m in active TTY mode
- 24 V DC or AC power supply suitable for control cabinet
- Active data transmission indicated by separate data indicators for the transmit and receive channels
- Convenient connection for variable cable lengths, enabling the TTY connection on the field side to be established via plug-in screw terminal blocks
- RS-232 connection via D-SUB 9 and standard RS-232 cable
- High-quality 3-way isolation up to 2 kV (VCC // RS-232 // TTY)
- Mounting on standard EN DIN rails
- Integrated surge protection with transient discharge to the DIN rail

Application:

The following tasks are generally solved with the converters (see illustration):

- Interface adaptation between RS-232 and TTY interfaces
- Increased range of up to 1000 m
- Programming connection between PC (RS-232) and, for example, S5 controllers with TTY programming interface for temporary coupling

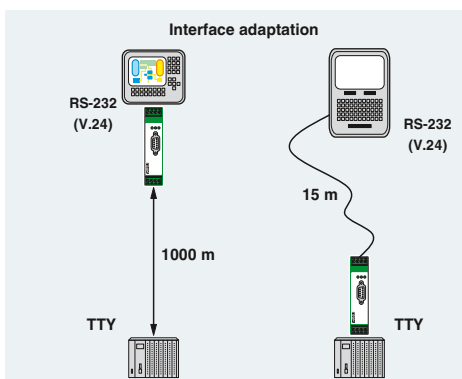

Supply	
Supply voltage	
Nominal current consumption	
RS-232 Interface	
Transmission speed	
Transmission length	
Connection method	
TTY interface	
Transmission speed	
Transmission length	
Connection method	
Operating mode	
Load	
General data	
Bit distortion	
Bit delay	
Test voltage	
Ambient temperature range	
Housing material	
Transmission channels	
Electrical isolation	
Dimensions	W / H / D
EMC note	
Conformance / approvals	
UL, USA / Canada	



TTY

RS-232



TTY converter, 2 channels



Technical data

24 V AC/DC ±20 %
75 mA (24 V DC)
RS-232 interface according to ITU-T V.28, EIA/TIA-232, DIN 66259-1
≤ 19.2 kbps
15 m (twisted pair)
D-SUB-9 plug
TTY interface, CL2 according to DIN 66348-1
≤ 19.2 kbps
1000 m (twisted pair)
Plug-in screw connection
Active, semi active, passive
≤ 500 Ω
< 5 %
< 3 μs
2 kV
0 °C ... 55 °C
PA
2 (1/1), RxD, TxD, full duplex
VCC // RS-232 // TTY
22.5 mm / 99 mm / 118.6 mm
Class A product, see page 527

508 recognized
Class I, Div. 2, Groups A, B, C, D

Ordering data

Type	Order No.	Pcs. / Pkt.
PSM-ME-RS232/TTY-P	2744458	1

Accessories

PSM-KA 9 SUB 25/BB/2METER	2761059	1
PSM-KA9SUB9/BB/2METER	2799474	1

Description

Interface converter, for conversion from RS-232 to TTY, with electrical isolation, two channels, rail-mountable

RS-232-D-SUB cable , length: 2 m
- 9-pos. socket on 25-pos. socket
- 9-pos. socket on 9-pos. socket

Copper transmission

Interface converters

RS-232 / RS-422 (V.11)

RS-232 / RS-485

The RS-422 standard can be used to set up rapid, interference-free point-to-point connections in industrial applications. Connections covering a distance of up to 1200 m can be established using a twisted-pair and shielded 4-wire cable.

The RS-485 standard allows more than two devices to communicate with one another. Converting the RS-232 point-to-point interface into the bus-capable RS-485 standard makes it possible to network up to 32 devices via a 2 or 4-wire cable.

PSM-ME-RS232/RS485-P

This interface converter converts TxD/RxD data signals with speeds of up to 115.2 kbps on the RS-232 interface bidirectionally into either RS-422 or RS-485 signals. The RS-232 connection is established via a 9-pos. D-SUB, and the RS-422/RS-485 field connection is established using COMBICON plug-in screw terminal blocks.

Features:

- RS-422 4-wire point-to-point mode
- RS-485 2-wire mode, half duplex
- RS-485 4-wire mode, full duplex
- Automatic RS-485 transmit/receive changeover
- Transmission speed between 4.8 kbps and 115.2 kbps
- Integrated data indicator for dynamic indication of send and receive data
- High-quality 3-way isolation between power supply, RS-232, and RS-422/485 for reliable decoupling of the potentials with 2 kV
- Integrated surge protection with transient discharge to the DIN rail

Applications:

- Fast and interference-free point-to-point connection between two RS-232 interfaces via RS-422
- Increase in range or remote transmission up to 1200 m
- Programming or parameterizing link between PC (RS-232) and a piece of equipment such as a PLC or variable frequency drive with an RS-422 connection
- A temporary programming or parameterizing link can be set up between a PC (RS-232) and a piece of equipment such as a PLC or variable frequency drive with an RS-485 connection

PSM-EG-RS 232/RS 422-P/4K

The PSM-EG... control cabinet module also converts the RS-232 signals in full duplex mode with a data rate of up to 64 kbps to the powerful RS-422 standard. However, in addition to the TxD/RxD transmit and receive channels, the converter also provides two further channels for transmitting RTS and CTS control lines.

Features:

- RS-422 4-wire point-to-point mode
- High-quality 3-way isolation between power supply, RS-232, and RS-422 for reliable electrical isolation of the potentials with 2.5 kV
- Integrated surge protection with transient discharge to the DIN rail
- Transmission speed of up to 64 kbps

Applications:

- Fast and interference-free point-to-point connection between two RS-232 interfaces via RS-422
- Programming or parameterizing link between PC (RS-232) and a piece of equipment such as a PLC or variable frequency drive with an RS-422 connection
- Increased range of up to 1200 m, incl. control cables

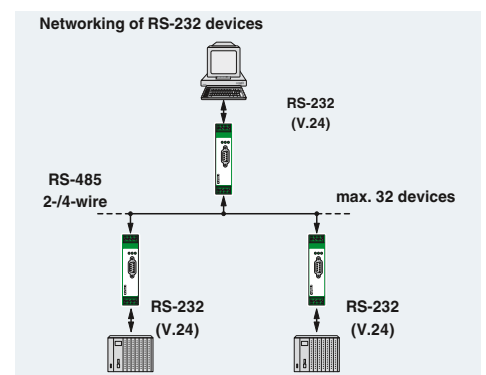
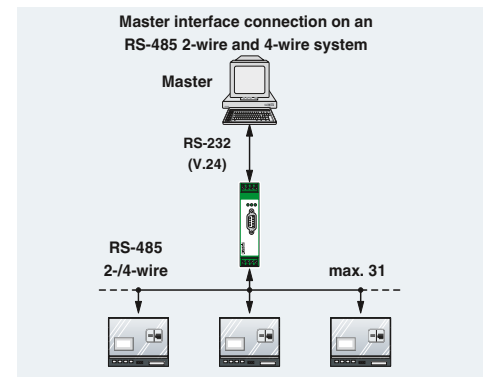
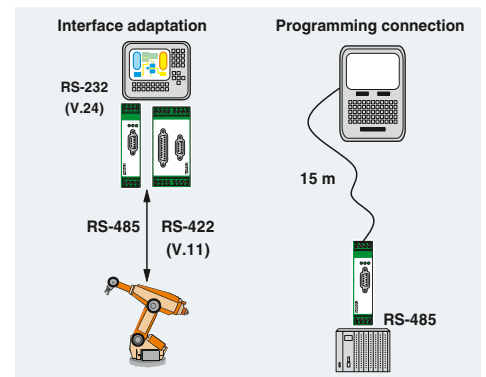
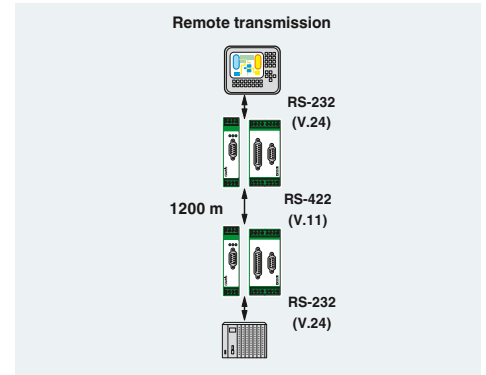



RS-232 converter for RS-422 and RS-485, 2 channels



RS-232 converter for RS-422, 4 channels



	Technical data	Technical data
Supply		
Supply voltage range	18 V AC/DC ... 30 V AC/DC (via plug-in COMBICON screw terminal block)	19.2 V DC ... 28.8 V DC
Nominal current consumption	85 mA (24 V DC)	130 mA (24 V DC)
RS-232 Interface	RS-232 interface according to ITU-T V.28, EIA/TIA-232, DIN 66259-1	RS-232 interface according to ITU-T V.28, EIA/TIA-232, DIN 66259-1
Transmission speed	1.2; 2.4; 4.8; 7.2; 9.6; 19.2; 31.25; 38.4; 57.6; 75; 93.75; 115.2 kbps	64 kbps
Connection method	D-SUB-9 plug	D-SUB-9 plug
RS-422 interface	RS-422 interface according to ITU-T V.11, EIA/TIA-422, DIN 66348-1	RS-422 interface according to ITU-T V.11, EIA/TIA-422, DIN 66348-1
Termination resistor	390 Ω / 150 Ω / 390 Ω (can be connected)	510 Ω / 150 Ω / 510 Ω (can be connected)
Transmission speed	1.2; 2.4; 4.8; 9.6; 19.2; 38.4; 57.6; 75; 93.75; 115.2 kbps	64 kbps
Transmission length	1200 m (twisted pair)	1200 m (twisted pair)
Connection method	Plug-in screw connection	D-SUB-15 connector
RS-485 interface	RS-485 interface according to EIA/TIA-485, DIN 66259-1	
Data direction switching	Automatic control or via RTS/CTS	-
Termination resistor	390 Ω / 150 Ω / 390 Ω (can be connected)	-
Transmission speed	1.2; 2.4; 4.8; 9.6; 19.2; 38.4; 57.6; 75; 93.75; 115.2 kbps	-
Transmission length	1200 m (twisted pair)	-
Connection method	Plug-in screw connection	-
General data		
Bit distortion	≤ 5 %	≤ 5 %
Bit delay	≤ 2.5 μs	≤ 3 μs
Test voltage	1.5 kV AC	2.5 kV
Ambient temperature range	-40 °C ... 70 °C	0 °C ... 50 °C
Housing material	PA 6.6-FR	ABS
Transmission channels	2 (1/1), Rx/D, Tx/D, full duplex	4 (2/2), Rx/D, Tx/D, RTS, CTS; full duplex
Electrical isolation	VCC // RS-232 // RS-485 // FE	VCC // RS-232 // RS-422
Dimensions	22.5 mm / 99 mm / 114.5 mm	45 mm / 75 mm / 110 mm
EMC note	Class A product, see page 527	Class A product, see page 527
Conformance / approvals		
UL, USA / Canada	-	cUL 508 Recognized

	Ordering data			Ordering data		
Description	Type	Order No.	Pcs. / Pkt.	Type	Order No.	Pcs. / Pkt.
Interface converter , for conversion from RS-232 to RS-485, with electrical isolation, rail-mountable, changeover of data direction self-controlling or through RTS/CTS						
- two channels	PSM-ME-RS232/RS485-P	2744416	1			
Interface converter , for conversion from RS-232 to RS-422 (V.11), with electrical isolation, rail-mountable						
- 4 channels				PSM-EG-RS232/RS422-P/4K	2761266	1
	Accessories			Accessories		
RS-232-D-SUB cable , length: 2 m						
- 9-pos. socket on 25-pos. socket	PSM-KA 9 SUB 25/BB/2METER	2761059	1	PSM-KA 9 SUB 25/BB/2METER	2761059	1
- 9-pos. socket on 9-pos. socket	PSM-KA9SUB9/BB/2METER	2799474	1	PSM-KA9SUB9/BB/2METER	2799474	1

FO converters for PROFIBUS

The **PSI-MOS-PROFIB/FO... E** devices convert copper-based PROFIBUS interfaces to fiber optics.

The integrated optical diagnostics allow permanent monitoring of the FO paths during installation and also during operation. The floating switch contact is activated when the signal output on the fiber optic paths drops to a critical level.

Depending on which wavelength is used in conjunction with the corresponding fibers, transmission distances of 70 m to 45 km can be achieved between two devices.

Depending on the wavelength, devices can be used with polymer, HCS, and fiberglass.

- Automatic data rate detection or fixed data rate setting via DIP switches
- Suitable for all data rates of up to 12 Mbps
- Integrated optical diagnostics for continuous monitoring of fiber optic paths
- Floating switch contact for leading alarm generation in relation to critical fiber optic paths
- High-quality electrical isolation between all interfaces (PROFIBUS // fiber optic ports // power supply // DIN rail connector)
- Bit retiming for any cascading depth
- Routing of supply voltage and data signals through DIN rail connectors
- Redundant power supply supported in the form of optional system power supply unit
- Can be combined with the PSI copper repeater for PROFIBUS in a modular way using DIN rail connectors

The **PSI-MOS-PROFIB/FO... E** terminal devices convert a PROFIBUS interface for an **FO cable**. They are ideal for point-to-point connections.

The **PSI-MOS-PROFIB/FO... T** T-couplers allow the interface to be converted for two **FO cables**. They can be used to create linear structures and ring structures for increased system availability.



Supply	
Supply voltage range	
Nominal current consumption	
RS-485 interface	
Data format/coding	
Transmission speed	
Transmission length	
Connection method	
Optical interface	
Connection	
Wavelength	
Transmission length incl. 3 dB system reserve	
General data	
Bit delay	
Alarm output	
Ambient temperature range	
Dimensions	W / H / D
EMC note	
Conformance / approvals	
ATEX	
UL, USA / Canada	

Description
FO converter , for converting data signals to fiber optics
- Terminal device with one FO interface
- T-coupler with two FO interfaces

DIN rail connector (optional), for routing through the supply voltage and data signal, two pieces are required per device
DIN rail connector (optional) for routing through of the supply voltage, 2 required per device

System power supply , primary-switched

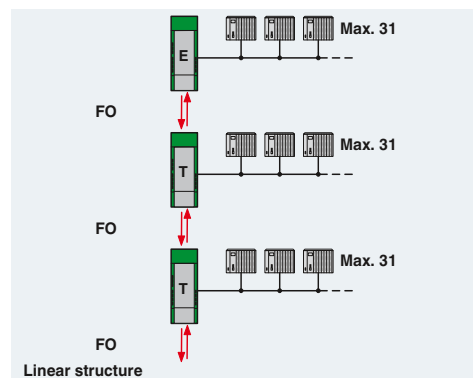



PROFIBUS
polymer and PCF fibers



PROFIBUS
PCF and fiberglass
(multi mode)



PROFIBUS
fiberglass
(multi mode and single mode)



Technical data
18 V DC ... 30 V DC 100 mA (24 V DC) PROFIBUS according to IEC 61158, RS-485 2-wire, half duplex, automatic control UART (11 bit, NRZ) ≤ 12 Mbps ≤ 1200 m (depending on the data rate, with shielded, twisted pair data cable) D-SUB-9 socket
F-SMA 660 nm 70 m (with F-P 980/1000 230 dB/km with quick mounting plug) 400 m (with F-K 200/230 10 dB/km with quick mounting plug)
< 1 bit 60 V DC / 42 V AC; 0.46 A -20 °C ... 60 °C 35 mm / 99 mm / 106 mm Class A product, see page 527
Ex II 3 G Ex nAC IIC T4 X Ex II (2) GD [Ex op is] IIC (PTB 06 ATEX 2042 U) Class I, Zone 2, AEx nc IIC T5 Class I, zone 2, Ex nC nL IIC T5 X Class I, Div. 2, Groups A, B, C, D

Technical data
18 V DC ... 30 V DC 120 mA (24 V DC) PROFIBUS according to IEC 61158, RS-485 2-wire, half duplex, automatic control UART (11 bit, NRZ) ≤ 12 Mbps ≤ 1200 m (depending on the data rate, with shielded, twisted pair data cable) D-SUB-9 socket
B-FOC (ST®) 850 nm 2600 m (with F-G 50/125 2.5 dB/km) 3300 m (with F-G 62.5/125 3.0 dB/km) 800 m (with F-K 200/230 10 dB/km with quick mounting plug)
< 1 bit 60 V DC / 42 V AC; 0.46 A -20 °C ... 60 °C 35 mm / 99 mm / 106 mm Class A product, see page 527
Ex II 3 G Ex nAC IIC T4 X Ex II (2) GD [Ex op is] IIC (PTB 06 ATEX 2042 U) Class I, Zone 2, AEx nc IIC T5 Class I, zone 2, Ex nC nL IIC T5 X Class I, Div. 2, Groups A, B, C, D

Technical data
18 V DC ... 32 V DC 55 mA (24 V DC) PROFIBUS according to IEC 61158, RS-485 2-wire, half duplex, automatic control UART (11 bit, NRZ) ≤ 12 Mbps ≤ 1200 m (depending on the data rate, with shielded, twisted pair data cable) D-SUB-9 socket
SC duplex 1300 nm 25 km (with F-G 50/125 0.7 dB/km at 1300 nm) 22 km (with F-G 62.5/125 0.8 dB/km at 1300 nm) 45 km (with F-E 9/125 0.4 dB/km at 1300 nm)
< 1 bit 60 V DC / 42 V AC; 1 A -20 °C ... 60 °C 35 mm / 105 mm / 106 mm Class A product, see page 527
Ex II 3 G Ex nA nC IIC T4 Gc X 508 listed 508 recognized

Ordering data		
Type	Order No.	Pcs. / Pkt.
PSI-MOS-PROFIB/FO 660 E	2708290	1
PSI-MOS-PROFIB/FO 660 T	2708287	1

Ordering data		
Type	Order No.	Pcs. / Pkt.
PSI-MOS-PROFIB/FO 850 E	2708274	1
PSI-MOS-PROFIB/FO 850 T	2708261	1

Ordering data		
Type	Order No.	Pcs. / Pkt.
PSI-MOS-PROFIB/FO1300 E	2708559	1
PSI-MOS-PROFIB/FO1300 T	2708892	1

Accessories		
Type	Order No.	Pcs. / Pkt.
ME 17,5 TBUS 1,5/ 5-ST-3,81 GN	2709561	10
ME 17,5 TBUS 1,5/PP000-3,81 BK	2890014	10
MINI-SYS-PS-100-240AC/24DC/1.5	2866983	1

Accessories		
Type	Order No.	Pcs. / Pkt.
ME 17,5 TBUS 1,5/ 5-ST-3,81 GN	2709561	10
ME 17,5 TBUS 1,5/PP000-3,81 BK	2890014	10
MINI-SYS-PS-100-240AC/24DC/1.5	2866983	1

Accessories		
Type	Order No.	Pcs. / Pkt.
ME 17,5 TBUS 1,5/ 5-ST-3,81 GN	2709561	10
ME 17,5 TBUS 1,5/PP000-3,81 BK	2890014	10
MINI-SYS-PS-100-240AC/24DC/1.5	2866983	1

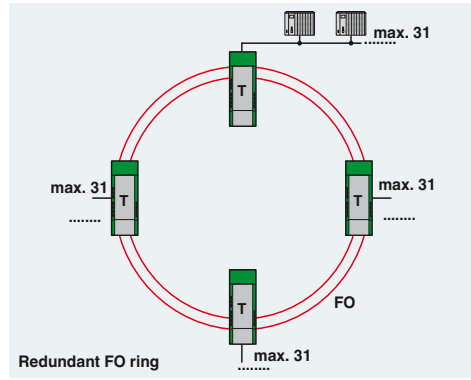
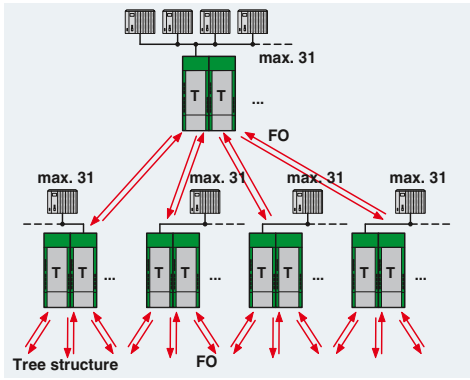
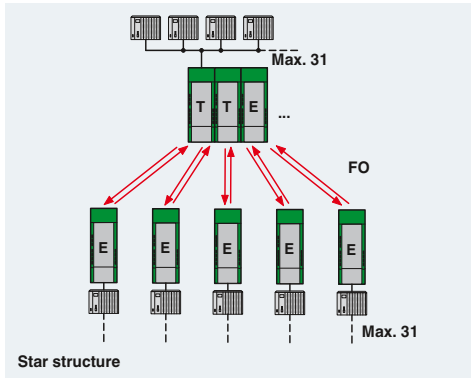

FO converters for ControlNet

With the infrastructure components for ControlNet, copper-based and fiber optic networks can benefit from the advantages of active devices. The main advantage is the electrically isolated connection of bus devices, which means that the negative effects of voltage equalization currents and electromagnetic interference on the bus cables are a thing of the past. In addition, bus cable short circuits only affect the specific potential segment concerned. In addition to interference-free and electrically isolated networking, the use of fiber optic technology also enables longer branch lines and star and tree structures to be created.

- Integrated optical diagnostics for continuous monitoring of fiber optic paths
- Floating switch contact for leading alarm generation in relation to critical fiber optic paths
- High-quality electrical isolation between all interfaces (ControlNet // fiber optic ports // power supply // DIN rail connector)
- Routing of supply voltage and data signals through DIN rail connectors
- Redundant power supply supported in the form of optional system power supply unit
- Can be combined with the PSI copper repeater in a modular way using DIN rail connectors

The **PSI-MOS-CNET/FO... E** terminal device converts a PROFIBUS interface for a **fiber optic cable**. It is ideal for point-to-point connections.

The **PSI-MOS-CNET/FO... T** T-coupler allows the interface to be converted for **two FO cables**. This device can be used to create redundant network structures for increased system availability.

Supply
Supply voltage range
Nominal current consumption
ControlNet interface
Transmission speed
Transmission length
Connection method
Optical interface
Connection
Wavelength
Transmission length incl. 3 dB system reserve

General data	
Bit delay	
Alarm output	
Test voltage	
Ambient temperature range	
Electrical isolation	
Dimensions	W / H / D
EMC note	
Conformance / approvals	
ATEX	

UL, USA / Canada

Description

FO converter, for converting data signals to fiber optics

- Terminal device with one FO interface
- T-coupler with two FO interfaces

DIN rail connector (optional), for routing through the supply voltage and data signal, two pieces are required per device

System power supply, primary-switched

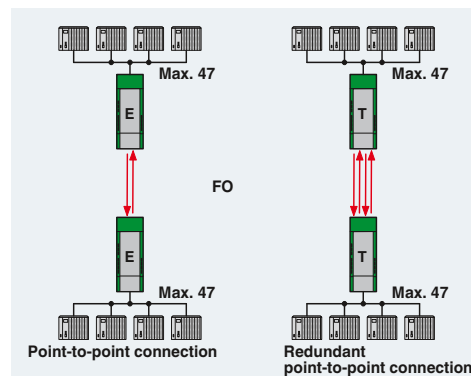

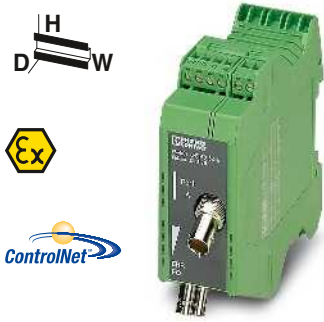

**ControlNet,
one optical channel**

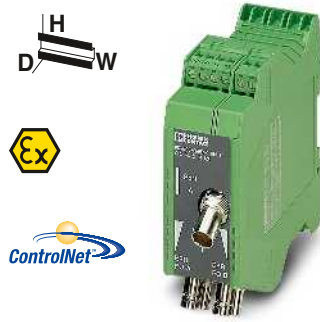

**ControlNet,
two optical channels**

Ex:

Ex:

Technical data	
18 V DC ... 30 V DC (via plug-in COMBICON screw terminal block)	
100 mA (24 V DC)	
ControlNet interface, according to EN 50170	
5 Mbps	
≤ 1000 m	
BNC 75 Ω	
B-FOC (ST®)	
850 nm	
1200 m (with F-K 200/230 8 dB/km with quick mounting plug)	
3100 m (with F-G 50/125 2.5 dB/km)	
3000 m (with F-G 62,5/125 3.0 dB/km)	
< 3 Bit	
18 V DC ... 30 V DC; 500 mA	
1.5 kV _{rms} (50 Hz, 1 min.)	
-20 °C ... 60 °C	
VCC // ControlNet™	
35 mm / 105 mm / 117 mm	
Class A product, see page 527	
II 3 G Ex nA IIC T4 Gc X II (2) G [Ex op is Gb] IIC (PTB 06 ATEX 2042 U) II (2) D [Ex op is Db] IIC (PTB 06 ATEX 2042 U) 508 listed	

Technical data	
18 V DC ... 30 V DC (via plug-in COMBICON screw terminal block)	
100 mA (24 V DC)	
ControlNet interface, according to EN 50170	
5 Mbps	
≤ 1000 m	
BNC 75 Ω	
B-FOC (ST®)	
850 nm	
1200 m (with F-K 200/230 8 dB/km with quick mounting plug)	
3100 m (with F-G 50/125 2.5 dB/km)	
3000 m (with F-G 62,5/125 3.0 dB/km)	
< 3 Bit	
18 V DC ... 30 V DC; 500 mA	
1.5 kV _{rms} (50 Hz, 1 min.)	
-20 °C ... 60 °C	
VCC // ControlNet™	
35 mm / 105 mm / 117 mm	
Class A product, see page 527	
II 3 G Ex nA IIC T4 Gc X II (2) G [Ex op is Gb] IIC (PTB 06 ATEX 2042 U) II (2) D [Ex op is Db] IIC (PTB 06 ATEX 2042 U) 508 listed	

Ordering data		
Type	Order No.	Pcs. / Pkt.
PSI-MOS-CNET/FO 850 E	2313711	1

Ordering data		
Type	Order No.	Pcs. / Pkt.
PSI-MOS-CNET/FO 850 T	2313724	1

Accessories		
ME 17,5 TBUS 1,5/ 5-ST-3,81 GN	2709561	10
MINI-SYS-PS-100-240AC/24DC/1.5	2866983	1

Accessories		
ME 17,5 TBUS 1,5/ 5-ST-3,81 GN	2709561	10
MINI-SYS-PS-100-240AC/24DC/1.5	2866983	1

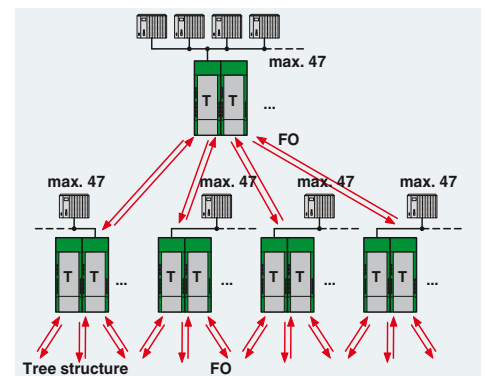
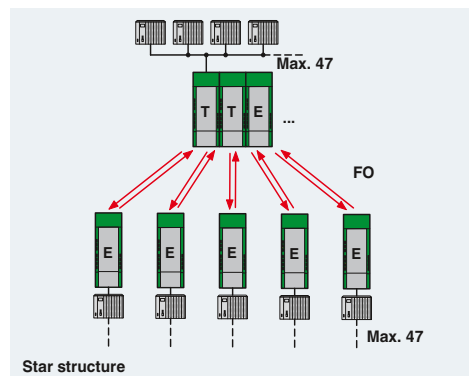
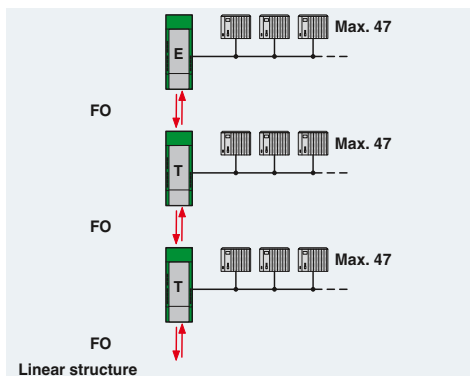

Fiber optics transmission

FO converters for DeviceNet and CANopen

The PSI-MOS-DNET... fiber optic transmission system enables DeviceNet™ and CANopen® users to benefit from simple and interference-free networking based on fiber optics. In addition, bus cable short circuits only affect the specific potential segment concerned. This increases overall availability and improves flexibility when designing the bus topology. The use of fiber optic technology enables branch lines and star and tree structures to be created.

The 22.5 mm space-saving devices from the **PSI-MOS-DNET CAN/FO...** series feature an internal backplane. The maximum network expansion that can be achieved (sum total of copper and fiber optic cables) essentially depends on the data rate used.

- Data rates of up to 800 kbps, set via DIP switches
- Integrated optical diagnostics for continuous monitoring of fiber optic paths
- Floating switch contact in basic module for leading alarm generation in relation to critical fiber optic paths
- High-quality electrical isolation between all interfaces (DeviceNet // fiber optic port // power supply // backplane)
- Integrated backplane for routing through the supply voltage and data signals

Thanks to extended functions, the modular devices in the **PSI-MOS-DNET/FO...** series support network expansion that is not dependent on the data rate.

- Automatic data rate detection or fixed data rate setting via DIP switches
- Data rates of up to 1000 kbps
- Integrated optical diagnostics for continuous monitoring of fiber optic paths
- Floating switch contact for leading alarm generation in relation to critical fiber optic paths
- High-quality electrical isolation between all interfaces (DeviceNet // fiber optic ports // power supply // DIN rail connector)
- Routing of supply voltage and data signals through DIN rail connectors
- Redundant power supply supported in the form of optional system power supply unit
- Can be combined with the PSI copper repeater in a modular way using DIN rail connectors

Supply		
Supply voltage range		
Nominal current consumption		
CAN interface		
Termination resistor		
Transmission speed		
Transmission length		
Connection method		
Optical interface		
Connection		
Wavelength		
Transmission length incl. 3 dB system reserve		
General data		
Bit delay		
Alarm output		
Test voltage		
Ambient temperature range		
Dimensions		W / H / D
EMC note		
Conformance / approvals		
ATEX		
UL, USA / Canada		

Description

FO converter, for converting data signals to fiber optics

- Basic module with one FO interface
- Extension module with a fiber optics interface
- Terminal device with one FO interface
- T-coupler with two FO interfaces

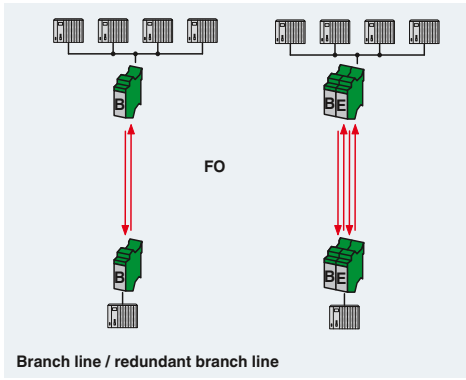



DeviceNet

CANopen

DeviceNet™ and CANopen®
Polymer and PCF fibers



DeviceNet

CANopen

DeviceNet™ and CANopen®
PCF and fiberglass
(multi mode)



DeviceNet

CANopen

DeviceNet™ and CANopen®
PCF and fiberglass
(multi mode) external backplane



Technical data
10 V DC ... 30 V DC (via plug-in COMBICON screw terminal block)
100 mA (24 V DC)
CAN interface, according to ISO/IS 11898 for DeviceNet, CAN, CANopen
120 Ω (can be connected)
≤ 800 kbps
≤ 5000 m (dependent on the data rate and the protocol used)
Plug-in screw connection
F-SMA
660 nm
100 m (with F-P 980/1000 230 dB/km with quick mounting plug)
800 m (with F-K 200/230 10 dB/km with quick mounting plug)
< 1 bit
60 V DC / 42 V AC; 0.46 A
1.5 kV _{rms} (50 Hz, 1 min.)
-20 °C ... 60 °C
22.5 mm / 99 mm / 114.5 mm
Class A product, see page 527
Ex II 3 G Ex nAC IIC T4 X
Ex II (2) GD [Ex op is] IIC (PTB 06 ATEX 2042 U)
Class I, Zone 2, AEx nc IIC T5
Class I, Div. 2, Groups A, B, C, D

Technical data
10 V DC ... 30 V DC (via plug-in COMBICON screw terminal block)
100 mA (24 V DC)
CAN interface, according to ISO/IS 11898 for DeviceNet, CAN, CANopen
120 Ω (can be connected)
≤ 800 kbps
≤ 5000 m (dependent on the data rate and the protocol used)
Plug-in screw connection
B-FOC (ST®)
850 nm
2800 m (with F-K 200/230 8 dB/km with quick mounting plug)
4800 m (with F-G 50/125 2.5 dB/km)
4200 m (with F-G 62,5/125 3.0 dB/km)
< 1 bit
60 V DC / 42 V AC; 0.46 A
1.5 kV _{rms} (50 Hz, 1 min.)
-20 °C ... 60 °C
22.5 mm / 99 mm / 114.5 mm
Class A product, see page 527
Ex II 3 G Ex nAC IIC T4 X
Ex II (2) GD [Ex op is] IIC (PTB 06 ATEX 2042 U)
Class I, Zone 2, AEx nc IIC T5
Class I, Div. 2, Groups A, B, C, D

Technical data
11 V DC ... 30 V DC (via plug-in COMBICON screw terminal block)
130 mA (24 V DC)
CAN interface, according to ISO/IS 11898 for DeviceNet, CAN, CANopen
124 Ω (integrated and ready to be switched)
≤ 1 Mbps (configurable via DIP switches)
≤ 5000 m (dependent on the data rate and the protocol used)
COMBICON plug-in screw terminal block
B-FOC (ST®)
850 nm
1800 m (with F-K 200/230 8 dB/km with quick mounting plug)
4600 m (with F-G 50/125 2.5 dB/km)
4200 m (with F-G 62,5/125 3.0 dB/km)
≤ 1 bit (configurable)
11 V DC ... 30 V DC; 500 mA
1.5 kV _{rms} (50 Hz, 1 min.)
-20 °C ... 60 °C
35 mm / 102 mm / 119 mm
Class A product, see page 527
Ex II (2) D [Ex op is Db] IIC (PTB 06 ATEX 2042 U)
Ex II (2) G [Ex op is Gb] IIC (PTB 06 ATEX 2042 U)
Ex II 3 G Ex nA IIC T4 Gc X
508 listed

Ordering data		
Type	Order No.	Pcs. / Pkt.
PSI-MOS-DNET CAN/FO 660/BM	2708054	1
PSI-MOS-DNET CAN/FO 660/EM	2708067	1

Ordering data		
Type	Order No.	Pcs. / Pkt.
PSI-MOS-DNET CAN/FO 850/BM	2708083	1
PSI-MOS-DNET CAN/FO 850/EM	2708096	1

Ordering data		
Type	Order No.	Pcs. / Pkt.
PSI-MOS-DNET/FO 850 E	2313999	1
PSI-MOS-DNET/FO 850 T	2313986	1

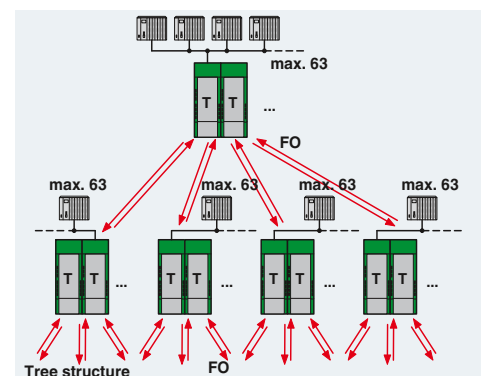
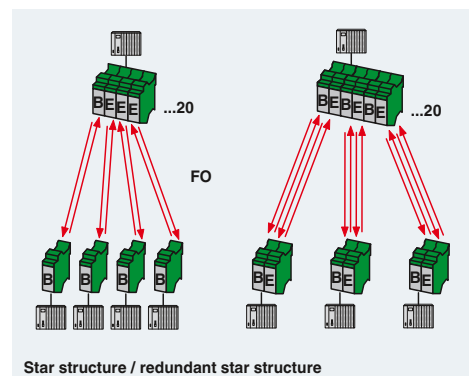
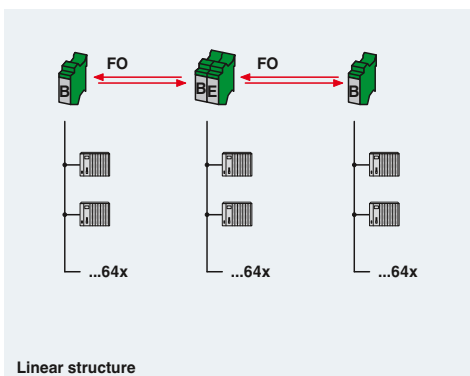

Fiber optics transmission

FO converters for RS-485 2-wire bus systems

The RS-485 2-wire interface is the most widely used interface in the field of automation technology. Well-known bus systems, such as SUCONET K, MODBUS ASCII, MODBUS RTU, S-BUS, and DH-485, are all based on this interface, as are many other company-specific bus systems.

The **PSI-MOS-RS485W2/FO... FO** converters convert the electrical data signal into an optical one by protocol transparent means.

The integrated optical diagnostics allow permanent monitoring of the FO paths during installation and also during operation. The floating switch contact is activated when the signal output on the fiber optic paths drops to a critical level.

Depending on which wavelength is used in conjunction with the corresponding fibers, distances of 100 m to 45 km can be achieved between two devices.

- Automatic data rate detection or fixed data rate setting via DIP switches
- Suitable for data rates of up to 500 kbps
- Integrated optical diagnostics for continuous monitoring of fiber optic paths
- Floating switch contact for leading alarm generation in relation to critical fiber optic paths
- High-quality electrical isolation between all interfaces (RS-485 // fiber optic ports // power supply // DIN rail connector)
- Routing of supply voltage and data signals through DIN rail connectors
- Redundant power supply supported in the form of optional system power supply unit
- Can be combined with the PSI copper repeater in a modular way using DIN rail connectors

The **PSI-MOS-RS485W2/FO... E** terminal devices convert an RS-485 interface to a fiber optic cable. They are ideal for point-to-point connections.

The **PSI-MOS-RS485W2/FO... T** T-couplers allow the interface to be converted for **two FO cables**. They can be used to create linear structures and redundant structures for increased system availability.



Supply voltage range
Nominal current consumption
RS-485 interface
Data format/coding
Termination resistor
Transmission speed
Transmission length
Connection method
Optical interface
Connection
Wavelength
Transmission length incl. 3 dB system reserve

General data
Bit delay
Alarm output
Test voltage
Ambient temperature range
Dimensions W / H / D
EMC note
Conformance / approvals
ATEX
UL, USA / Canada

Description

FO converter, for converting data signals to fiber optics

- Terminal device with one FO interface
 - T-coupler with two FO interfaces

DIN rail connector (optional), for routing through the supply voltage and data signal, two pieces are required per device

DIN rail connector (optional) for routing through of the supply voltage, 2 required per device

System power supply unit, primary-switched

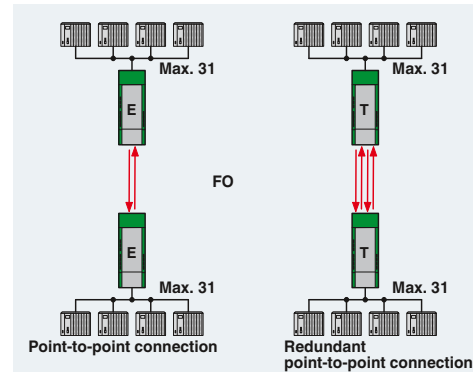



RS-485 2-wire
polymer and PCF fibers



RS-485 2-wire
PCF and fiberglass
(multi mode)

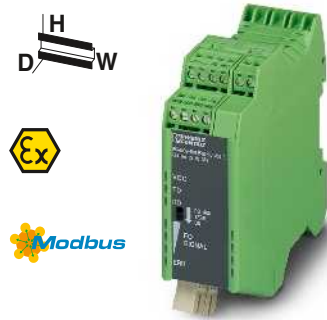

RS-485 2-wire
fiberglass
(multi mode and single mode)



Technical data	
18 V DC ... 30 V DC	
100 mA (24 V DC)	
RS-485 interface, 2-wire	
UART (11/10 bit switchable; NRZ), slip-tolerant	
390 Ω / 220 Ω / 390 Ω (can be connected)	
4.8/ 9.6/ 19.2/ 38.4/ 57.6/ 75/ 93.75/ 115.2/ 136/ 187.5/ 375/ 500 kbps	
≤ 1200 m (depending on the data rate, with shielded, twisted data cable)	
Plug-in screw connection	
F-SMA	
660 nm	
100 m (with F-P 980/1000 230 dB/km with quick mounting plug)	
800 m (with F-K 200/230 10 dB/km with quick mounting plug)	
< 1 bit	
60 V DC / 42 V AC; 0.46 A	
1.5 kV _{rms} (50 Hz, 1 min.)	
-20 °C ... 60 °C	
35 mm / 99 mm / 105 mm	
Class A product, see page 527	
Ex II 3 G Ex nAC IIC T4 X	
Ex II (2) GD [Ex op is] IIC (PTB 06 ATEX 2042 U)	
Class I, Zone 2, AEx nc IIC T5	
Class I, zone 2, Ex nC nL IIC T5 X	
Class I, Div. 2, Groups A, B, C, D	

Technical data	
18 V DC ... 30 V DC	
120 mA (24 V DC)	
RS-485 interface, 2-wire	
UART (11/10 bit switchable; NRZ), slip-tolerant	
390 Ω / 220 Ω / 390 Ω (can be connected)	
4.8/ 9.6/ 19.2/ 38.4/ 57.6/ 75/ 93.75/ 115.2/ 136/ 187.5/ 375/ 500 kbps	
≤ 1200 m (depending on the data rate, with shielded, twisted data cable)	
Plug-in screw connection	
B-FOC (ST®)	
850 nm	
2800 m (with F-K 200/230 8 dB/km with quick mounting plug)	
4200 m (with F-G 50/125 2.5 dB/km)	
3300 m (with F-G 62.5/125 3.0 dB/km)	
< 1 bit	
60 V DC / 42 V AC; 0.46 A	
1.5 kV _{rms} (50 Hz, 1 min.)	
-20 °C ... 60 °C	
35 mm / 99 mm / 105 mm	
Class A product, see page 527	
Ex II 3 G Ex nAC IIC T4 X	
Ex II (2) GD [Ex op is] IIC (PTB 06 ATEX 2042 U)	
Class I, Zone 2, AEx nc IIC T5	
Class I, zone 2, Ex nC nL IIC T5 X	
Class I, Div. 2, Groups A, B, C, D	

Technical data	
18 V DC ... 32 V DC	
55 mA (24 V DC)	
RS-485 interface, 2-wire	
UART (11/10 bit switchable; NRZ), slip-tolerant	
390 Ω / 220 Ω / 390 Ω (can be connected)	
4.8/ 9.6/ 19.2/ 38.4/ 57.6/ 75/ 93.75/ 115.2/ 136/ 187.5/ 375/ 500 kbps	
≤ 1200 m (depending on the data rate, with shielded, twisted data cable)	
Plug-in screw connection	
SC duplex	
1300 nm	
25 km (with F-G 50/125 0.7 dB/km at 1300 nm)	
22 km (with F-G 62.5/125 0.8 dB/km at 1300 nm)	
45 km (with F-E 9/125 0.4 dB/km at 1300 nm)	
< 1 bit	
60 V DC / 42 V AC; 1 A	
1.5 kV _{rms} (50 Hz, 1 min.)	
-20 °C ... 60 °C	
35 mm / 99 mm / 105 mm	
Class A product, see page 527	
Ex II 3 G Ex nA nC IIC T4 Gc X	
508 listed	
508 recognized	

Ordering data		
Type	Order No.	Pcs. / Pkt.
PSI-MOS-RS485W2/FO 660 E	2708313	1
PSI-MOS-RS485W2/FO 660 T	2708300	1

Ordering data		
Type	Order No.	Pcs. / Pkt.
PSI-MOS-RS485W2/FO 850 E	2708339	1
PSI-MOS-RS485W2/FO 850 T	2708326	1

Ordering data		
Type	Order No.	Pcs. / Pkt.
PSI-MOS-RS485W2/FO1300 E	2708562	1

Accessories		
Type	Order No.	Pcs. / Pkt.
ME 17,5 TBUS 1,5/ 5-ST-3,81 GN	2709561	10
ME 17,5 TBUS 1,5/PP000-3,81 BK	2890014	10
MINI-SYS-PS-100-240AC/24DC/1.5	2866983	1

Accessories		
Type	Order No.	Pcs. / Pkt.
ME 17,5 TBUS 1,5/ 5-ST-3,81 GN	2709561	10
ME 17,5 TBUS 1,5/PP000-3,81 BK	2890014	10
MINI-SYS-PS-100-240AC/24DC/1.5	2866983	1

Accessories		
Type	Order No.	Pcs. / Pkt.
ME 17,5 TBUS 1,5/ 5-ST-3,81 GN	2709561	10
ME 17,5 TBUS 1,5/PP000-3,81 BK	2890014	10
MINI-SYS-PS-100-240AC/24DC/1.5	2866983	1

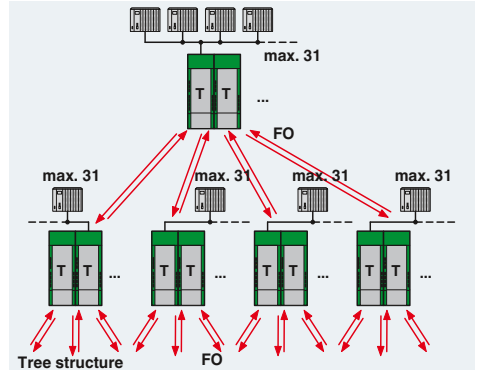
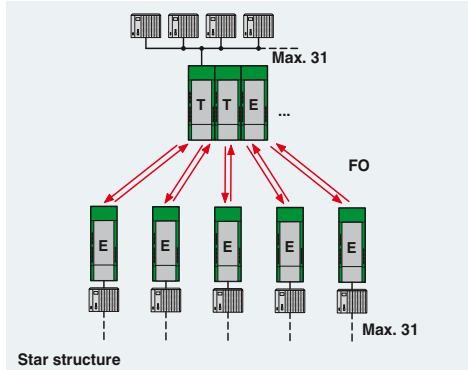
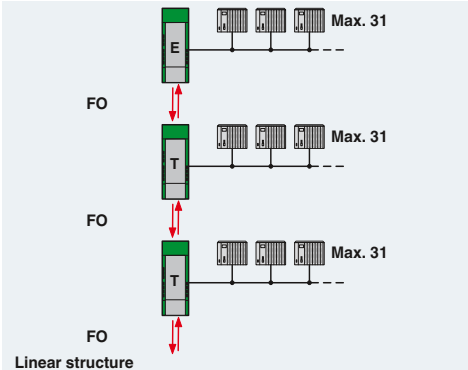

Fiber optics transmission

FO converters for INTERBUS, RS-422, and RS-485 4-wire bus systems

The **PSI-MOS-RS422/FO...** devices are used for converting INTERBUS interfaces for fiber optics. The conversion is performed using a transparent protocol for all data rates up to max. 2 Mbps. The integrated optical diagnostics allow permanent monitoring of the FO paths during installation and also during operation. The floating switch contact is activated when the signal output on the fiber optic paths drops to a critical level. This early alarm generation enables critical system states to be diagnosed before they result in failure.

INTERBUS lines are constructed with the **PSI-MOS-RS422...E terminal devices**. The **PSI-MOS-RS422...T T-couplers** also allow redundant **INTERBUS connections** via fiber optics.

If RS-422 terminal devices are used, only one terminal device can be connected to each PSI-MOS-RS422/FO... device. If devices with an RS-485 4-wire interface are used, it is possible to create a network with up to 31 slave devices connected to one FO converter. In both cases, a suitable communication protocol capable of terminal device addressing is required (e.g., Modbus RTU).

- Automatic data rate detection for all data rates up to 2 Mbps
- Integrated optical diagnostics for continuous monitoring of fiber optic paths
- Floating switch contact for leading alarm generation in relation to critical fiber optic paths
- High-quality electrical isolation between all interfaces (copper // FO ports // supply // DIN rail connector)
- Connections can be plugged in using a COMBICON screw terminal block
- Redundant power supply supported in the form of optional system power supply unit
- Routing through of the supply voltage via the DIN rail connector
- Approved for use in zone 2
- Intrinsically safe FO interface (Ex op is) for direct connection to devices in zone 1 (all 660 and 850 nm versions)

Supply	
Supply voltage range	
Nominal current consumption	
RS-422 interface	
Transmission speed	
Transmission length	
Connection method	
Optical interface	
Connection	
Wavelength	
Transmission length incl. 3 dB system reserve	
General data	
Bit delay	
Alarm output	
Test voltage	
Ambient temperature range	
Dimensions	W / H / D
EMC note	
Conformance / approvals	
ATEX	
UL, USA / Canada	

Description
FO converter , for converting data signals to fiber optics
- Terminal device with one FO interface
- T-coupler with two FO interfaces

DIN rail connector (optional) for routing through of the supply voltage, 2 required per device
System power supply unit , primary-switched

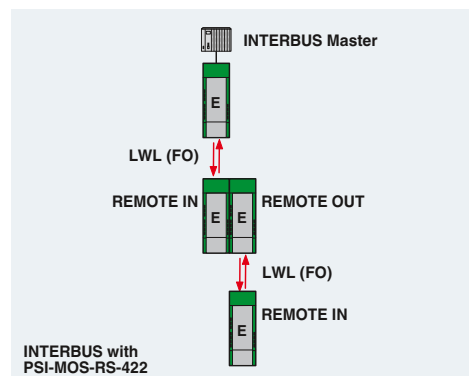



INTERBUS / RS-422 / RS-485 4-wire polymer and PCF fibers



INTERBUS / RS-422 / RS-485 4-wire PCF and fiberglass (multi mode)



INTERBUS / RS-422 / RS-485 4-wire fiberglass (multi mode and single mode)



Technical data
18 V DC ... 30 V DC 100 mA (24 V DC) RS-422 interface according to ITU-T V.11, EIA/TIA-422, DIN 66348-1
≤ 2 Mbps ≤ 1000 m (depending on the data rate, with shielded, twisted data cable) Plug-in screw connection
F-SMA 660 nm 100 m (with F-P 980/1000 230 dB/km with quick mounting plug) 800 m (with F-K 200/230 10 dB/km with quick mounting plug)
< 1 bit 60 V DC / 42 V AC; 0.46 A 1.5 kV _{rms} (50 Hz, 1 min.) -20 °C ... 60 °C 35 mm / 99 mm / 103 mm Class A product, see page 527
<ul style="list-style-type: none"> II 3 G Ex nAC IIC T4 X II (2) GD [Ex op is] IIC (PTB 06 ATEX 2042 U) Class I, Zone 2, AEx nc IIC T5 Class I, zone 2, Ex nC nL IIC T5 X Class I, Div. 2, Groups A, B, C, D

Technical data
18 V DC ... 30 V DC 120 mA (24 V DC) RS-422 interface according to ITU-T V.11, EIA/TIA-422, DIN 66348-1
≤ 2 Mbps ≤ 1000 m (depending on the data rate, with shielded, twisted data cable) Plug-in screw connection
B-FOC (ST®) 850 nm 2800 m (with F-K 200/230 8 dB/km with quick mounting plug) 4200 m (with F-G 50/125 2.5 dB/km) 4800 m (with F-G 62,5/125 3.0 dB/km)
< 1 bit 60 V DC / 42 V AC; 0.46 A 1.5 kV _{rms} (50 Hz, 1 min.) -20 °C ... 60 °C 35 mm / 99 mm / 103 mm Class A product, see page 527
<ul style="list-style-type: none"> II 3 G Ex nAC IIC T4 X II (2) GD [Ex op is] IIC (PTB 06 ATEX 2042 U) Class I, Zone 2, AEx nc IIC T5 Class I, zone 2, Ex nC nL IIC T5 X Class I, Div. 2, Groups A, B, C, D

Technical data
18 V DC ... 32 V DC 110 mA (24 V DC) RS-422 interface according to ITU-T V.11, EIA/TIA-422, DIN 66348-1
≤ 2 Mbps ≤ 1000 m (depending on the data rate, with shielded, twisted data cable) Plug-in screw connection
SC duplex 1300 nm 27 km (with F-G 50/125 0.7 dB/km at 1300 nm) 22 km (with F-G 62,5/125 0.8 dB/km at 1300 nm) 45 km (with F-E 9/125 0,4 dB/km at 1300 nm)
< 1 bit 60 V DC / 42 V AC; 1 A 1.5 kV _{rms} (50 Hz, 1 min.) -20 °C ... 60 °C 35 mm / 105 mm / 103 mm Class A product, see page 527
<ul style="list-style-type: none"> II 3 G Ex nA nC IIC T4 Gc X
508 listed 508 recognized

Ordering data		
Type	Order No.	Pcs. / Pkt.
PSI-MOS-RS422/FO 660 E	2708342	1
PSI-MOS-RS422/FO 660 T	2708384	1

Ordering data		
Type	Order No.	Pcs. / Pkt.
PSI-MOS-RS422/FO 850 E	2708355	1
PSI-MOS-RS422/FO 850 T	2708397	1

Ordering data		
Type	Order No.	Pcs. / Pkt.
PSI-MOS-RS422/FO1300 E	2708575	1

Accessories		
Type	Order No.	Pcs. / Pkt.
ME 17,5 TBUS 1,5/PP000-3,81 BK	2890014	10
MINI-SYS-PS-100-240AC/24DC/1.5	2866983	1

Accessories		
Type	Order No.	Pcs. / Pkt.
ME 17,5 TBUS 1,5/PP000-3,81 BK	2890014	10
MINI-SYS-PS-100-240AC/24DC/1.5	2866983	1

Accessories		
Type	Order No.	Pcs. / Pkt.
ME 17,5 TBUS 1,5/PP000-3,81 BK	2890014	10
MINI-SYS-PS-100-240AC/24DC/1.5	2866983	1

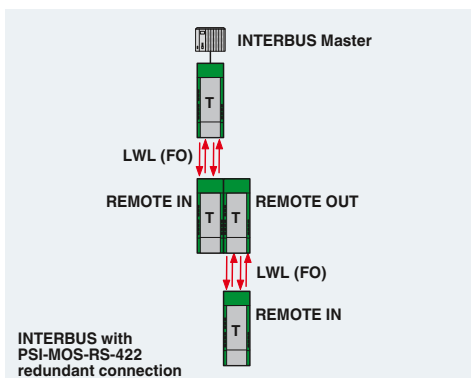

Fiber optics transmission

FO converters for RS-232

Due to its electrical properties, the RS-232 is very susceptible to EMC influences and potential differences. For this reason, it can only be used for short distances of up to max. 15 m. FO transmission technology is therefore the first choice for longer transmission distances and for eliminating EMC influences. The **PSI-MOS-RS232/FO...** devices convert the RS-232 interface for fiber optics. A transparent protocol is used for conversion. If addressable RS-232 devices and a suitable communication protocol are used, even multi-point networks can be constructed. These can be implemented as linear, star, and even redundant star structures.

- Automatic data rate detection for all data rates up to 115.2 kbps
- Integrated optical diagnostics for continuous monitoring of fiber optic paths
- Floating switch contact for leading alarm generation in relation to critical fiber optic paths
- High-quality electrical isolation between all interfaces (RS-232 // fiber optic ports // power supply // DIN rail connector)
- Redundant power supply supported in the form of optional system power supply unit
- Connections can be plugged in using a COMBICON screw terminal block
- Routing of supply voltage and data signals through DIN rail connectors
- Approved for use in zone 2
- Intrinsically safe FO interface (Ex op is) for direct connection to devices in zone 1 (all 660 and 850 nm versions)

Supply
Supply voltage range
Nominal current consumption
RS-232 Interface
Transmission speed
Transmission length
Connection method
Optical interface
Connection
Wavelength
Transmission length incl. 3 dB system reserve

General data	
Bit delay	
Alarm output	
Test voltage	
Ambient temperature range	
Dimensions	W / H / D
EMC note	
Conformance / approvals	
ATEX	
UL, USA / Canada	

Description
FO converter , for converting data signals to fiber optics
- Terminal device with one FO interface
- T-coupler with two FO interfaces

DIN rail connector (optional), for routing through the supply voltage and data signal, two pieces are required per device
DIN rail connector (optional), for routing through the supply voltage, 2 required per device

System power supply unit , primary-switched
--

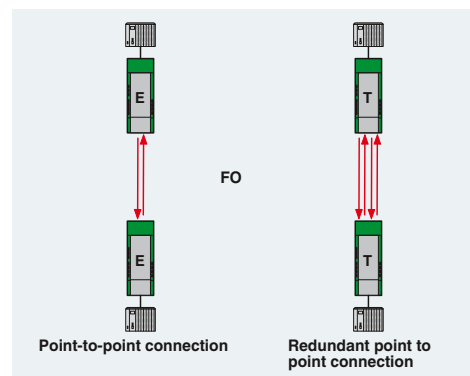



RS-232

RS-232
polymer and PCF fibers



RS-232

RS-232
PCF and fiberglass
(multi mode)



RS-232

RS-232
fiberglass
(multi mode and single mode)



Technical data
18 V DC ... 30 V DC 100 mA (24 V DC) RS-232 interface according to ITU-T V.28, EIA/TIA-232, DIN 66259-1 115.2 kbps (NRZ) ≤ 15 m D-SUB-9 plug
F-SMA 660 nm 100 m (with F-P 980/1000 230 dB/km with quick mounting plug) 800 m (with F-K 200/230 10 dB/km with quick mounting plug)
< 1 bit 60 V DC / 42 V AC; 0.46 A 1.5 kV _{rms} (50 Hz, 1 min.) -20 °C ... 60 °C 35 mm / 99 mm / 105 mm Class A product, see page 527
Ex II 3 G Ex nAC IIC T4 X Ex II (2) GD [Ex op is] IIC (PTB 06 ATEX 2042 U) Class I, Zone 2, AEx nc IIC T5 Class I, zone 2, Ex nC nL IIC T5 X Class I, Div. 2, Groups A, B, C, D

Technical data
18 V DC ... 30 V DC 120 mA (24 V DC) RS-232 interface according to ITU-T V.28, EIA/TIA-232, DIN 66259-1 115.2 kbps (NRZ) ≤ 15 m D-SUB-9 plug
B-FOC (ST®) 850 nm 2800 m (with F-K 200/230 8 dB/km with quick mounting plug) 4200 m (with F-G 50/125 2.5 dB/km) 4800 m (with F-G 62.5/125 3.0 dB/km)
< 1 bit 60 V DC / 42 V AC; 0.46 A 1.5 kV _{rms} (50 Hz, 1 min.) -20 °C ... 60 °C 35 mm / 99 mm / 105 mm Class A product, see page 527
Ex II 3 G Ex nAC IIC T4 X Ex II (2) GD [Ex op is] IIC (PTB 06 ATEX 2042 U) Class I, Zone 2, AEx nc IIC T5 Class I, zone 2, Ex nC nL IIC T5 X Class I, Div. 2, Groups A, B, C, D

Technical data
18 V DC ... 32 V DC 100 mA (24 V DC) RS-232 interface according to ITU-T V.28, EIA/TIA-232, DIN 66259-1 115.2 kbps (NRZ) ≤ 15 m D-SUB-9 plug
SC duplex 1300 nm 27 km (with F-G 50/125 0.7 dB/km at 1300 nm) 22 km (with F-G 62.5/125 0.8 dB/km at 1300 nm) 45 km (with F-E 9/125 0.4 dB/km at 1300 nm)
< 1 bit 60 V DC / 42 V AC; 1 A 1.5 kV _{rms} (50 Hz, 1 min.) -20 °C ... 60 °C 35 mm / 99 mm / 105 mm Class A product, see page 527
Ex II 3 G Ex nA nC IIC T4 Gc X 508 listed 508 recognized

Ordering data		
Type	Order No.	Pcs. / Pkt.
PSI-MOS-RS232/FO 660 E	2708368	1
PSI-MOS-RS232/FO 660 T	2708410	1

Ordering data		
Type	Order No.	Pcs. / Pkt.
PSI-MOS-RS232/FO 850 E	2708371	1
PSI-MOS-RS232/FO 850 T	2708423	1

Ordering data		
Type	Order No.	Pcs. / Pkt.
PSI-MOS-RS232/FO 1300 E	2708588	1

Accessories		
Type	Order No.	Pcs. / Pkt.
ME 17,5 TBUS 1,5/ 5-ST-3,81 GN	2709561	10
ME 17,5 TBUS 1,5/PP000-3,81 BK	2890014	10
MINI-SYS-PS-100-240AC/24DC/1.5	2866983	1

Accessories		
Type	Order No.	Pcs. / Pkt.
ME 17,5 TBUS 1,5/ 5-ST-3,81 GN	2709561	10
ME 17,5 TBUS 1,5/PP000-3,81 BK	2890014	10
MINI-SYS-PS-100-240AC/24DC/1.5	2866983	1

Accessories		
Type	Order No.	Pcs. / Pkt.
ME 17,5 TBUS 1,5/ 5-ST-3,81 GN	2709561	10
ME 17,5 TBUS 1,5/PP000-3,81 BK	2890014	10
MINI-SYS-PS-100-240AC/24DC/1.5	2866983	1

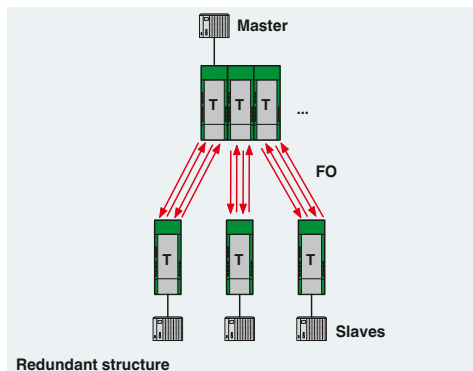
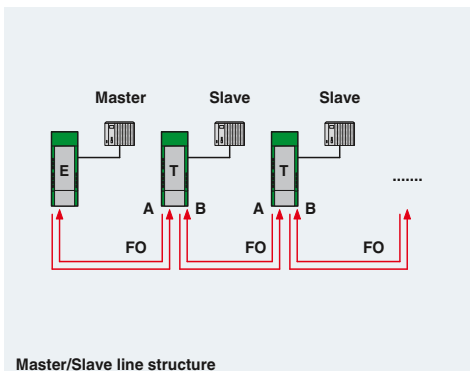
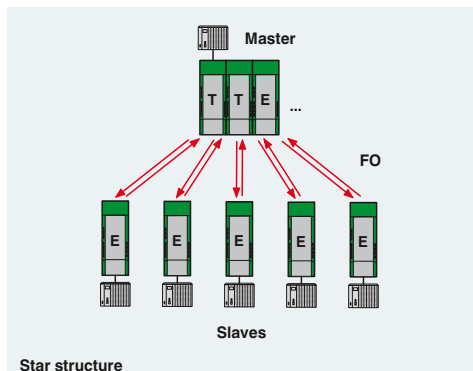

Fiber optics transmission

Universal POF cable for assembly, type KDHEAVY-1011

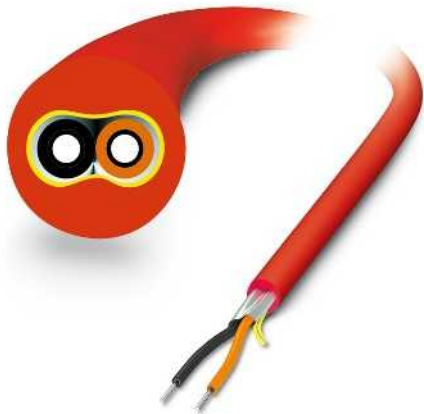

- Universal installation cable for fixed installation indoors
- 2.2 mm individual wires made from extremely hard-wearing polyamide chloride (PA)
- Halogen-free, ozone and UV resistant
- Robust polyurethane (PUR) outer cable sheath

Free end



OE

FSMA connector, IP20



FSMA

SC-RJ plug, IP20



SCRJ

B-FOC (ST®) plug, IP20



BFOC

Free end	FSMA connector, IP20	SC-RJ plug, IP20
OE	FSMA	SCRJ
Ordering data	Ordering data	Ordering data
Order No.	Order No.	Order No.
By the meter 2744319	Variable 2901553	Variable 2901553
Variable 2901553	Variable 2901553	Variable 2901553
Variable 2901553	Variable 2901553	Variable 2901553
Variable 2901553	Variable 2901553	Variable 2901553
Variable 2901553	Variable 2901553	Variable 2901553

Ordering example for configured cable:

For a POF cable, fitted at one end with an SC-RJ connector and a B-FOC(ST®) connector, IP20 at the other end, and a length of 15 m, the ordering data is as follows:

Order No.	Connector 1	Connector 2	Length [m]
2901553	SCRJ	BFOC	15
Length:		Min. 0.5 m Max. 100 m	
Increment:		0.25 m 1 m ... 5 m 1 m 5 m ... 100 m	

Ordering example for cable sold by the meter:

For a POF cable with a length of 70 m, the ordering data is as follows:

Order No.	Length [m]		
2744319	70		
Length:		Min. 0.5 m Max. 500 m/cable drum	
Increment:		0.25 m 1 m ... 5 m 1 m 5 m ... 500 m	

**B-FOC (ST®) plug,
IP20**



BFOC

Ordering data

Order No.

Variable **2901553**

Variable **2901553**

Variable **2901553**

Variable **2901553**

Technical data

Cable data

Cable abbreviation according to IEC 61977: 2010	J-V11Y 4Y2P 980/1000 160A 10
Fibers	Polymer fiber, 980/1000 µm
Attenuation, typical	230 dB/km
Outer sheath	
Material	PUR
Color	red
Diameter	5.5 - 6.5 mm
Strain relief elements	Non-metallic, aramid fiber

Individual wire

Structure	PA
Color	black/orange
Diameter	2.2 mm ±0.07 mm

General data

Weight	33 kg/km
Ambient temperature (operation)	-20 °C ... 70 °C
Ambient temperature (storage/transport)	-40 °C ... 80 °C
Ambient temperature (installation)	-5 °C ... 50 °C
Halogen-free as per:	According to IEC 60754-2

Fiber optics transmission

Robust POF cable for free assembly, type robust-1012

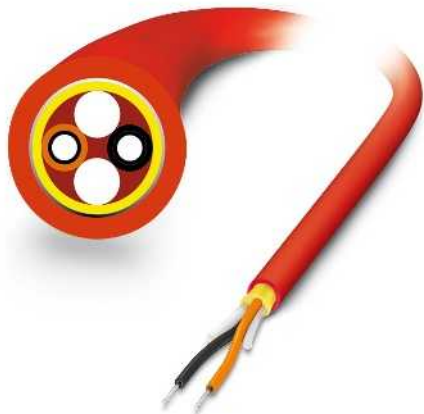

- Robust installation cable for fixed installation indoors
- Dimensioned for higher requirements in respect of tensile load and lateral pressure
- 2.2 mm individual wires made from extremely hard-wearing polyamide chloride (PA)
- Halogen-free, ozone and UV resistant
- Reinforced polyurethane (PUR) outer cable sheath

Free end	FSMA connector, IP20	SC-RJ plug, IP20
OE	FSMA	SCRJ
Ordering data	Ordering data	Ordering data
Order No.	Order No.	Order No.
By the meter 2744322	Variable 2901548	Variable 2901548
Variable 2901548	Variable 2901548	Variable 2901548
Variable 2901548	Variable 2901548	Variable 2901548
Variable 2901548	Variable 2901548	Variable 2901548
Variable 2901548	Variable 2901548	Variable 2901548

Free end



OE

FSMA connector, IP20



FSMA

SC-RJ plug, IP20



SCRJ

B-FOC (ST®) plug, IP20



BFOC

Ordering example for configured cable:

For a POF cable, fitted at one end with an SC-RJ connector and a B-FOC(ST®) connector, IP20 at the other end, and a length of 15 m, the ordering data is as follows:

Order No.	Connector 1	Connector 2	Length [m]
2901548	SCRJ	BFOC	15
Length:		Min. 0.5 m Max. 100 m	
Increment:		0.25 m 1 m ... 5 m 1 m 5 m ... 100 m	

Ordering example for cable sold by the meter:

For a POF cable with a length of 70 m, the ordering data is as follows:

Order No.	Length [m]		
2744322	70		
Length:		Min. 0.5 m Max. 500 m/cable drum	
Increment:		0.25 m 1 m ... 5 m 1 m 5 m ... 500 m	

**B-FOC (ST®) plug,
IP20**



BFOC

Ordering data

Order No.

Variable **2901548**

Variable **2901548**

Variable **2901548**

Variable **2901548**

Technical data

Cable data

Cable abbreviation according to IEC 61977: 2010	J-V11Y 4Y2P 980/1000 160A 10
Fibers	Polymer fiber, 980/1000 µm
Attenuation, typical	230 dB/km
Outer sheath	
Material	PUR
Color	red
Diameter	7.5 - 8.5 mm
Strain relief elements	Non-metallic, aramid fiber

Individual wire

Structure	PA
Color	black/orange
Diameter	2.2 mm ±0.07 mm

General data

Weight	54 kg/km
Ambient temperature (operation)	-20 °C ... 70 °C
Ambient temperature (storage/transport)	-40 °C ... 80 °C
Ambient temperature (installation)	-5 °C ... 50 °C
Halogen-free as per:	According to IEC 60754-2

Fiber optics transmission

Highly flexible POF cable for free assembly, type robust-FLEX-1013



- Highly flexible round cable for use in trailing cables or drag chains
- Dimensioned for an alternating bending frequency of up to 5,000,000 cycles
- 2.2 mm individual wires made from extremely hard-wearing polyamide chloride (PA)
- Halogen-free, ozone and UV resistant
- Robust polyurethane (PUR) outer cable sheath

	Free end	FSMA connector, IP20	SC-RJ plug, IP20
	OE	FSMA	SCRJ
	Ordering data	Ordering data	Ordering data
	Order No.	Order No.	Order No.
Free end			
	OE		
FSMA connector, IP20			
	FSMA		
SC-RJ plug, IP20			
	SCRJ		
B-FOC (ST®) plug, IP20			
	BFOC		
By the meter	2744335	Variable 2901549	Variable 2901549
Variable	2901549	Variable 2901549	Variable 2901549
Variable	2901549	Variable 2901549	Variable 2901549
Variable	2901549	Variable 2901549	Variable 2901549
Variable	2901549	Variable 2901549	Variable 2901549

Ordering example for configured cable:

For an POF cable, fitted at one end with an SC-RJ connector and a B-FOC(ST®) connector, IP20 at the other end, and a length of 15 m, the ordering data is as follows:

Order No.	Connector 1	Connector 2	Length [m]
2901549	SCRJ	BFOC	15
Length:	Min. 0.5 m Max. 100 m		
Increment:	0.25 m 1 m	1 m ... 5 m 5 m ... 100 m	

Ordering example for cable sold by the meter:

For a POF cable with a length of 70 m, the ordering data is as follows:

Order No.	Length [m]
2744335	70
Length:	Min. 0.5 m Max. 500 m/cable drum
Increment:	0.25 m 1 m ... 5 m 1 m 5 m ... 500 m

B-FOC (ST®) plug,
IP20



BFOC

Ordering data

Order No.

Variable 2901549

Variable 2901549

Variable 2901549

Variable 2901549

Technical data

Cable data

Cable abbreviation according to IEC 61977: 2010	J-V11Y 4Y2P 980/1000 180A 10
Fibers	Polymer fiber, 980/1000 µm
Attenuation, typical	275 dB/km
Outer sheath	
Material	PUR
Color	red
Diameter	7.5 - 8.5 mm
Strain relief elements	Non-metallic, aramid fiber

Individual wire

Structure	PA
Color	black/orange
Diameter	2.2 mm ± 0.07 mm

General data

Weight	54 kg/km
Ambient temperature (operation)	-20 °C ... 70 °C
Ambient temperature (storage/transport)	-40 °C ... 80 °C
Ambient temperature (installation)	-5 °C ... 50 °C
Halogen-free as per:	According to IEC 60754-2

Fiber optics transmission

PROFINET B POF cable for free assembly, type PN-B-1000

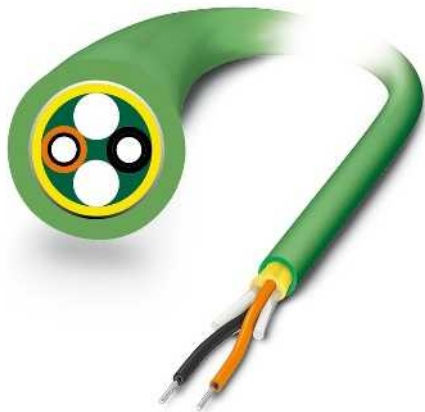

- Universal installation cable for fixed installation indoors
- 2.2 mm individual wires made from extremely hard-wearing polyamide chloride (PA)
- Halogen-free, ozone and UV resistant
- Robust polyurethane (PUR) outer cable sheath
- PROFIBUS type B

Ethernet



Free end



OE

FSMA connector, IP20



FSMA

SC-RJ plug, IP20



SCRJ

B-FOC (ST®) plug, IP20



BFOC

Free end	FSMA connector, IP20	SC-RJ plug, IP20
OE	FSMA	SCRJ
Ordering data	Ordering data	Ordering data
Order No.	Order No.	Order No.
By the meter 2313397	Variable 2901551	Variable 2901551
Variable 2901551	Variable 2901551	Variable 2901551
Variable 2901551	Variable 2901551	Variable 2901551
Variable 2901551	Variable 2901551	Variable 2901551
Variable 2901551	Variable 2901551	Variable 2901551

Ordering example for configured cable:

For a POF cable, fitted at one end with an SC-RJ connector and a B-FOC(ST®) connector, IP20 at the other end, and a length of 15 m, the ordering data is as follows:

Order No.	Connector 1	Connector 2	Length [m]
2901551	SCRJ	BFOC	15

Length:	Min. 0.5 m Max. 100 m	
Increment:	0.25 m 1 m	1 m ... 5 m 5 m ... 100 m

Ordering example for cable sold by the meter:

For a POF cable with a length of 70 m, the ordering data is as follows:

Order No.	Length [m]
2313397	70

Length:	Min. 0.5 m Max. 500 m/cable drum	
Increment:	0.25 m 1 m	1 m ... 5 m 5 m ... 500 m

B-FOC (ST®) plug,
IP20



BFOC

Ordering data

Order No.

Variable 2901551

Variable 2901551

Variable 2901551

Variable 2901551

Technical data

Cable data

Cable abbreviation according to IEC 61977: 2010	J-V11Y 4Y2P 980/1000 160A 10
Fibers	Polymer fiber, 980/1000 µm
Attenuation, typical	230 dB/km
Outer sheath	
Material	PUR
Color	Green
Diameter	7.5 - 8.5 mm
Strain relief elements	Non-metallic, aramid fiber

Individual wire

Structure	PA
Color	Black and orange with arrow labeling
Diameter	2.2 mm ±0.07 mm

General data

Weight	49 kg/km
Ambient temperature (operation)	-20 °C ... 70 °C
Ambient temperature (storage/transport)	-40 °C ... 80 °C
Ambient temperature (installation)	5 °C ... 50 °C
Halogen-free as per:	According to IEC 60754-2

Fiber optics transmission

Highly flexible PROFINET C POF cable for free assembly, type PN-C-1003



- Highly flexible round cable for use in trailing cables or drag chains
- Dimensioned for an alternating bending frequency of up to 5,000,000 cycles
- 2.2 mm individual wires made from extremely hard-wearing polyamide chloride (PA)
- Halogen-free, ozone and UV resistant
- Robust polyurethane (PUR) outer cable sheath
- PROFINET type C

Ethernet



Free end



OE

FSMA connector, IP20



FSMA

SC-RJ plug, IP20



SCRJ

B-FOC (ST®) plug, IP20



BFOC

Free end	FSMA connector, IP20	SC-RJ plug, IP20
OE	FSMA	SCRJ
Ordering data	Ordering data	Ordering data
Order No.	Order No.	Order No.
By the meter 2313407	Variable 2901552	Variable 2901552
Variable 2901552	Variable 2901552	Variable 2901552
Variable 2901552	Variable 2901552	Variable 2901552
Variable 2901552	Variable 2901552	Variable 2901552
Variable 2901552	Variable 2901552	Variable 2901552

Ordering example for configured cable:

For a POF cable, fitted at one end with an SC-RJ connector and a B-FOC(ST®) connector, IP20 at the other end, and a length of 15 m, the ordering data is as follows:

Order No.	Connector 1	Connector 2	Length [m]
2901552	SCRJ	BFOC	15

Length:	Min. 0.5 m Max. 100 m	
Increment:	0.25 m 1 m	1 m ... 5 m 5 m ... 100 m

Ordering example for cable sold by the meter:

For a POF cable with a length of 70 m, the ordering data is as follows:

Order No.	Length [m]
2313407	70

Length:	Min. 0.5 m Max. 500 m/cable drum	
Increment:	0.25 m 1 m	1 m ... 5 m 5 m ... 500 m

B-FOC (ST®) plug,
IP20



BFOC

Ordering data

Order No.

Variable 2901552

Variable 2901552

Variable 2901552

Variable 2901552

Technical data

Cable data

Cable abbreviation according to IEC 61977: 2010	J-V11Y 4Y2P 980/1000 180A 10
Fibers	Polymer fiber, 980/1000 µm
Attenuation, typical	275 dB/km
Outer sheath	
Material	PUR
Color	Green
Diameter	7.5 - 8.5 mm
Strain relief elements	Non-metallic, aramid fiber

Individual wire

Structure	PA
Color	Black and orange with arrow labeling
Diameter	2.2 mm ±0.07 mm

General data

Weight	51 kg/km
Ambient temperature (operation)	-20 °C ... 70 °C
Ambient temperature (storage/transport)	-40 °C ... 80 °C
Ambient temperature (installation)	5 °C ... 50 °C
Halogen-free as per:	According to IEC 60754-2

Fiber optics transmission

Universal PROFINET B HCS cable for free assembly, type PN-B-HCS-1018



- Universal installation cable for fixed installation indoors
- 2.2 mm individual wires made from extremely hard-wearing polyvinyl chloride (PVC)
- Ozone and UV resistant
- PVC outer cable sheath
- PROFINET type B

Ethernet



Free end



OE

FSMA connector, IP20



FSMA

SC-RJ plug, IP20



SCRJ

SC duplex plug, IP20



SCDUP

B-FOC (ST®) plug, IP20



BFOC

LC plug



LC

Free end	FSMA connector, IP20	SC-RJ plug, IP20
OE	FSMA	SCRJ
Ordering data	Ordering data	Ordering data
Order No.	Order No.	Order No.
By the meter 2313766	Variable 2901556	Variable 2901556
Variable 2901556	Variable 2901556	Variable 2901556
Variable 2901556	Variable 2901556	Variable 2901556
Variable 2901556	Variable 2901556	Variable 2901556
Variable 2901556	Variable 2901556	Variable 2901556
Variable 2901556	Variable 2901556	Variable 2901556

Ordering example for configured cable:

For an HCS cable, fitted at one end with an SC-RJ connector and a B-FOC(ST®) connector, IP20 at the other end, and a length of 15 m, the ordering data as follows:

Order No.	Connector 1	Connector 2	Length [m]
2901556	SCRJ	BFOC	15



Length:	Min. 1 m Max. 2000 m	
Increment:	0.25 m 1 m	1 m ... 5 m 5 m ... 2000 m

Ordering example for cable sold by the meter:

For an HCS cable with a length of 70 m, the ordering data is as follows:

Order No.	Length [m]
2313766	70

Length:	Min. 1 m Max. 2000 m/cable drum	
Increment:	0.25 m 1 m	1 m ... 5 m 5 m ... 2000 m

SC duplex plug, IP20	B-FOC (ST®) plug, IP20	LC plug
		
SCDUP	BFOC	LC
Ordering data	Ordering data	Ordering data
Order No.	Order No.	Order No.

Variable 2901556	Variable 2901556	Variable 2901556
Variable 2901556	Variable 2901556	Variable 2901556

Variable 2901556	Variable 2901556	Variable 2901556
Variable 2901556	Variable 2901556	Variable 2901556

Variable 2901556	Variable 2901556	Variable 2901556
Variable 2901556	Variable 2901556	Variable 2901556

	Technical data
Cable data	
Cable abbreviation according to IEC 61977: 2010	AT-V(ZN)YY 2K200/230 HCS
Fibers	HCS, 200/230 µm
Attenuation, typical	10 dB/km
Outer sheath	
Material	PVC
Color	Green
Diameter	6.7 - 7.7 mm
Strain relief elements	Non-metallic, aramid fiber
Individual wire	
Structure	PVC
Color	Black and orange with arrow labeling
Diameter	2.2 mm ±0.1 mm
Strain relief elements	Non-metallic, aramid fibers
General data	
Weight	45 kg/km
Ambient temperature (operation)	-40 °C ... 90 °C
Ambient temperature (storage/transport)	-40 °C ... 90 °C
Ambient temperature (installation)	-5 °C ... 50 °C

Fiber optics transmission

PROFINET C HCS broadband cable (GI) for free assembly, type PN-C-HCS-GI-1005

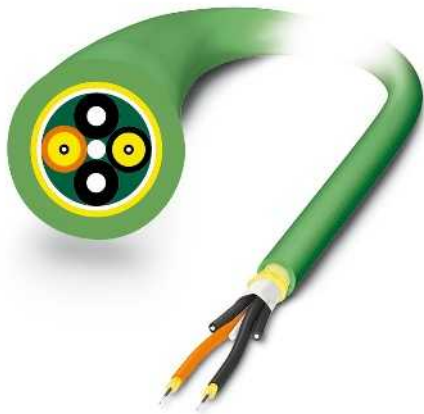

- Highly flexible round cable for use in trailing cables or drag chains
- Robust installation cable for indoor use
- Gradient index fiber for maximum performance requirements in terms of transmission bandwidth
- Can be used in 10/100/1000 Mbps Ethernet systems
- 2.2 mm individual wires made from polyvinyl chloride (PVC)
- Halogen-free, ozone and UV resistant
- Robust polyurethane (PUR) outer cable sheath
- Highly tear-resistant aramid strain relief elements
- PROFINET type C

Ethernet



Free end



OE

FSMA connector, IP20



FSMA

SC-RJ plug, IP20



SCRJ

SC duplex plug, IP20



SCDUP

B-FOC (ST®) plug, IP20



BFOC

LC plug



LC

Free end	FSMA connector, IP20	SC-RJ plug, IP20
OE	FSMA	SCRJ
Ordering data	Ordering data	Ordering data
Order No.	Order No.	Order No.
By the meter 2313410	Variable 2901554	Variable 2901554
Variable 2901554	Variable 2901554	Variable 2901554
Variable 2901554	Variable 2901554	Variable 2901554
Variable 2901554	Variable 2901554	Variable 2901554
Variable 2901554	Variable 2901554	Variable 2901554
Variable 2901554	Variable 2901554	Variable 2901554

Ordering example for configured cable:

For an HCS cable, fitted at one end with an SC-RJ connector and a B-FOC(ST®) connector, IP20 at the other end, and a length of 15 m, the ordering data as follows:

Order No.	Connector 1	Connector 2	Length [m]
2901554	SCRJ	BFOC	15



Length:	Min. 1 m	Max. 2000 m	
Increment:	0.25 m	1 m ... 5 m	5 m ... 2000 m
	1 m		

Ordering example for cable sold by the meter:

For an HCS cable with a length of 70 m, the ordering data is as follows:

Order No.	Length [m]
2313410	70

Length:	Min. 1 m	Max. 2000 m/cable drum	
Increment:	0.25 m	1 m ... 5 m	5 m ... 2000 m
	1 m		

SC duplex plug, IP20	B-FOC (ST®) plug, IP20	LC plug
		
SCDUP	BFOC	LC
Ordering data	Ordering data	Ordering data
Order No.	Order No.	Order No.

Variable 2901554	Variable 2901554	Variable 2901554
Variable 2901554	Variable 2901554	Variable 2901554

Variable 2901554	Variable 2901554	Variable 2901554
Variable 2901554	Variable 2901554	Variable 2901554

Variable 2901554	Variable 2901554	Variable 2901554
Variable 2901554	Variable 2901554	Variable 2901554

	Technical data
Cable data	
Cable abbreviation according to IEC 61977: 2010	J-V(ZN)12Y(ZN)11Y 2GK200/230 GI-HCS
Fibers	HCS gradient index, 200/230 µm
Attenuation, typical	18 dB/km
Outer sheath	
Material	PUR
Color	Green
Diameter	7.5 - 8.5 mm
Strain relief elements	Non-metallic, aramid fiber
Individual wire	
Structure	PVC
Color	Black and orange with arrow labeling
Diameter	2.2 mm ±0.1 mm
Strain relief elements	Non-metallic, aramid fibers
General data	
Weight	52 kg/km
Ambient temperature (operation)	-20 °C ... 70 °C
Ambient temperature (storage/transport)	-40 °C ... 70 °C
Ambient temperature (installation)	-5 °C ... 50 °C
Halogen-free as per:	According to IEC 60754-2

Fiber optics transmission

Robust HCS cable for free assembly, type HCS-robust-1014

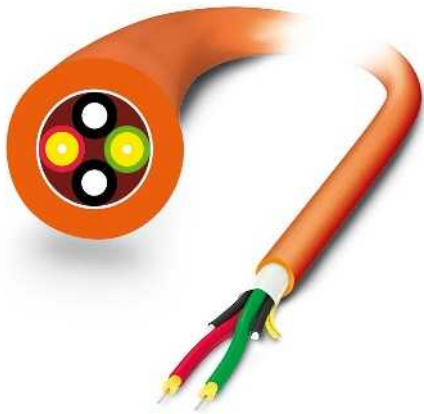

- Robust installation cable for indoor use
- Highly tear-resistant aramid strain relief elements
- 2.9 mm individual wires made from highly flexible FRNC material
- Halogen-free, ozone and UV resistant
- Robust polyurethane (PUR) outer cable sheath

	Free end	FSMA connector, IP20	SC-RJ plug, IP20
	OE	FSMA	SCRJ
	Ordering data	Ordering data	Ordering data
	Order No.	Order No.	Order No.
Free end			
	OE		
FSMA connector, IP20			
	FSMA		
SC-RJ plug, IP20			
	SCRJ		
SC duplex plug, IP20			
	SCDUP		
B-FOC (ST®) plug, IP20			
	BFOC		
LC plug			
	LC		
By the meter	2799885	Variable 2901555	Variable 2901555
Variable	2901555	Variable 2901555	Variable 2901555
Variable	2901555	Variable 2901555	Variable 2901555
Variable	2901555	Variable 2901555	Variable 2901555
Variable	2901555	Variable 2901555	Variable 2901555
Variable	2901555	Variable 2901555	Variable 2901555

Ordering example for configured cable:



For an HCS cable, fitted at one end with an SC-RJ connector and a B-FOC(ST®) connector, IP20 at the other end, and a length of 15 m, the ordering data is as follows:

Order No.	Connector 1	Connector 2	Length [m]
2901555	SCRJ	BFOC	15
Length:	Min. 1 m Max. 2000 m		
Increment:	0.25 m 1 m ... 5 m 1 m 5 m ... 2000 m		

Ordering example for cable sold by the meter:

For an HCS cable with a length of 70 m, the ordering data is as follows:

Order No.	Length [m]
2799885	70
Length:	Min. 1 m Max. 2000 m/cable drum
Increment:	0.25 m 1 m ... 5 m 1 m 5 m ... 2000 m

SC duplex plug, IP20	B-FOC (ST®) plug, IP20	LC plug
		
SCDUP	BFOC	LC
Ordering data	Ordering data	Ordering data
Order No.	Order No.	Order No.

Variable 2901555	Variable 2901555	Variable 2901555
Variable 2901555	Variable 2901555	Variable 2901555

Variable 2901555	Variable 2901555	Variable 2901555
Variable 2901555	Variable 2901555	Variable 2901555

Variable 2901555	Variable 2901555	Variable 2901555
Variable 2901555	Variable 2901555	Variable 2901555

	Technical data
Cable data	
Cable abbreviation according to IEC 61977: 2010	I-VH11Y 2K200/230 HCS
Fibers	HCS, 200/230 µm
Attenuation, typical	10 dB/km
Outer sheath	
Material	PUR
Color	orange
Diameter	7.5 - 8.5 mm
Individual wire	
Structure	FRNC material
Color	Red/Green
Diameter	2.9 mm ±0.1 mm
Strain relief elements	Non-metallic, aramid fibers
General data	
Weight	54 kg/km
Ambient temperature (operation)	-40 °C ... 70 °C
Ambient temperature (storage/transport)	-40 °C ... 70 °C
Ambient temperature (installation)	-20 °C ... 60 °C
Halogen-free as per:	According to IEC 60754-2

Fiber optics transmission

Outdoor cables for free assembly, type HCSO-1015



- Robust round cable for laying outdoors
- Longitudinally water-tight
- Integrated vapor barrier and rodent-proof scrim
- 2.9 mm individual wires made from highly flexible FRNC material
- Halogen-free, ozone and UV resistant
- Extremely robust polyethylene outer cable sheath

	Free end	FSMA connector, IP20	SC-RJ plug, IP20
	OE	FSMA	SCRJ
	Ordering data	Ordering data	Ordering data
	Order No.	Order No.	Order No.
Free end			
	OE		
FSMA connector, IP20			
	FSMA		
SC-RJ plug, IP20			
	SCRJ		
SC duplex plug, IP20			
	SCDUP		
B-FOC (ST®) plug, IP20			
	BFOC		
LC plug			
	LC		
By the meter	2799445	Variable 2901557	Variable 2901557
Variable	2901557	Variable 2901557	Variable 2901557
Variable	2901557	Variable 2901557	Variable 2901557
Variable	2901557	Variable 2901557	Variable 2901557
Variable	2901557	Variable 2901557	Variable 2901557
Variable	2901557	Variable 2901557	Variable 2901557

Ordering example for configured cable:



For an HCS cable, fitted at one end with an SC-RJ connector and a B-FOC(ST®) connector, IP20 at the other end, and a length of 15 m, the ordering data is as follows:

Order No.	Connector 1	Connector 2	Length [m]
2901557	SCRJ	BFOC	15
Length:	Min. 1 m Max. 1000 m		
Increment:	0.25 m 1 m ... 5 m 1 m 5 m ... 1000 m		

Ordering example for cable sold by the meter:

For an HCS cable with a length of 70 m, the ordering data is as follows:

Order No.	Length [m]
2799445	70
Length:	Min. 1 m Max. 1000 m/cable drum
Increment:	0.25 m 1 m ... 5 m 1 m 5 m ... 1000 m

SC duplex plug, IP20	B-FOC (ST®) plug, IP20	LC plug
		
SCDUP	BFOC	LC
Ordering data	Ordering data	Ordering data
Order No.	Order No.	Order No.

Variable 2901557	Variable 2901557	Variable 2901557
Variable 2901557	Variable 2901557	Variable 2901557

Variable 2901557	Variable 2901557	Variable 2901557
Variable 2901557	Variable 2901557	Variable 2901557

Variable 2901557	Variable 2901557	Variable 2901557
Variable 2901557	Variable 2901557	Variable 2901557

	Technical data
Cable data	
Cable abbreviation according to IEC 61977: 2010	AT-VQHB2Y 2K200/230 10A17+8B20
Fibers	HCS, 200/230 µm
Attenuation, typical	10 dB/km
Outer sheath	
Material	PE
Color	black
Diameter	10 - 11 mm
Strain relief elements	Non-metallic, aramid fiber
Rodent protection	Glass fibers
Lengthwise waterproofing	IEC 60794-1-2
Individual wire	
Structure	FRNC material
Color	Red/Green
Diameter	2.9 mm ±0.1 mm
Strain relief elements	Non-metallic, aramid fibers
General data	
Weight	97 kg/km
Ambient temperature (operation)	-20 °C ... 70 °C
Ambient temperature (storage/transport)	-25 °C ... 70 °C
Ambient temperature (installation)	-5 °C ... 50 °C
Halogen-free as per:	According to IEC 60754-2

Fiber optics transmission

Multi-mode fiberglass cables for free assembly, type GDM-robust-1016

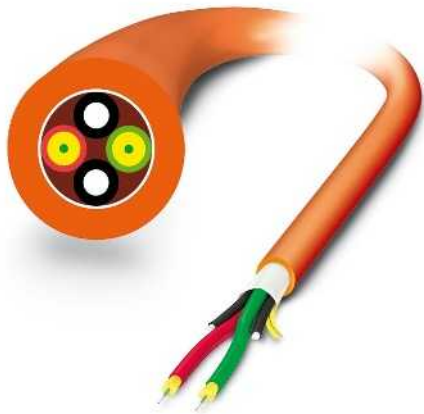

- Robust installation cable for indoor use
- Highly tear-resistant aramid strain relief elements
- 2.9 mm individual wires made from highly flexible FRNC material
- Halogen-free, ozone and UV resistant
- Robust polyurethane (PUR) outer cable sheath

	Free end	FSMA connector, IP20	SC-RJ plug, IP20
	OE	FSMA	SCRJ
	Ordering data	Ordering data	Ordering data
	Order No.	Order No.	Order No.
Free end			
	OE		
FSMA connector, IP20			
		FSMA	
SC-RJ plug, IP20			
			SCRJ
SC duplex plug, IP20			
			SCDUP
B-FOC (ST®) plug, IP20			
			BFOC
LC plug			
			LC
By the meter	2799322	Variable 2901558	Variable 2901558
Variable	2901558	Variable 2901558	Variable 2901558
Variable	2901558	Variable 2901558	Variable 2901558
Variable	2901558	Variable 2901558	Variable 2901558
Variable	2901558	Variable 2901558	Variable 2901558
Variable	2901558	Variable 2901558	Variable 2901558

Ordering example for configured cable:



For a fiberglass cable, fitted at one end with an SC-RJ connector and a B-FOC(ST®) connector, IP20 at the other end, and a length of 15 m, the ordering data is as follows:

Order No.	Connector 1	Connector 2	Length [m]
2901558	SCRJ	BFOC	15
Length:	Min. 1 m Max. 1000 m		
Increment:	1 m	1 m ... 1000 m	

Ordering example for cable sold by the meter:

For a fiberglass cable with a length of 70 m, the ordering data is as follows:

Order No.	Length [m]
2799322	70
Length:	Min. 1 m Max. 1000 m/cable drum
Increment:	1 m 1 m ... 1000 m

SC duplex plug, IP20	B-FOC (ST®) plug, IP20	LC plug
		
SCDUP	BFOC	LC
Ordering data	Ordering data	Ordering data
Order No.	Order No.	Order No.

Variable 2901558	Variable 2901558	Variable 2901558
Variable 2901558	Variable 2901558	Variable 2901558

Variable 2901558	Variable 2901558	Variable 2901558
Variable 2901558	Variable 2901558	Variable 2901558

Variable 2901558	Variable 2901558	Variable 2901558
Variable 2901558	Variable 2901558	Variable 2901558

	Technical data
Cable data	
Cable abbreviation according to IEC 61977: 2010	I-V(ZN)H11Y 2G50/125 2,5B600+0,7F1200
Fibers	Fiberglass, 50/125 µm
Attenuation, typical	2.5 dB/km
Outer sheath	
Material	PUR
Color	orange
Diameter	7.5 - 8.5 mm
Individual wire	
Structure	FRNC material
Color	Red/Green
Diameter	2.9 mm ±0.1 mm
Strain relief elements	Non-metallic, aramid fibers
General data	
Weight	50 kg/km
Ambient temperature (operation)	-20 °C ... 70 °C
Ambient temperature (storage/transport)	-25 °C ... 70 °C
Ambient temperature (installation)	-5 °C ... 50 °C
Halogen-free as per:	According to IEC 60754-2

Fiber optics transmission

Outdoor multi-mode fiberglass cables for free assembly, type GDO-1017



- Robust round cable for laying outdoors
- Longitudinally water-tight
- Integrated vapor barrier and rodent-proof scrim
- 2.9 mm individual wires made from highly flexible FRNC material
- Halogen-free, ozone and UV resistant
- Extremely robust polyethylene outer cable sheath

	Free end	FSMA connector, IP20	SC-RJ plug, IP20
	OE	FSMA	SCRJ
	Ordering data	Ordering data	Ordering data
	Order No.	Order No.	Order No.
Free end			
	OE		
FSMA connector, IP20			
	FSMA		
SC-RJ plug, IP20			
	SCRJ		
SC duplex plug, IP20			
	SCDUP		
B-FOC (ST®) plug, IP20			
	BFOC		
LC plug			
	LC		
By the meter	2799432	Variable	2901559
Variable	2901559	Variable	2901559
Variable	2901559	Variable	2901559
Variable	2901559	Variable	2901559
Variable	2901559	Variable	2901559
Variable	2901559	Variable	2901559
Variable	2901559	Variable	2901559
Variable	2901559	Variable	2901559

Ordering example for configured cable:

For a fiberglass cable, fitted at one end with an SC-RJ connector and a B-FOC(ST®) connector, IP20 at the other end, and a length of 15 m, the ordering data is as follows:

Order No.	Connector 1	Connector 2	Length [m]
2901559	SCRJ	BFOC	15
Length:	Min. 1 m Max. 1000 m		
Increment:	1 m	1 m ... 1000 m	

Ordering example for cable sold by the meter:

For a fiberglass cable with a length of 70 m, the ordering data is as follows:

Order No.	Length [m]
2799432	70
Length:	Min. 1 m Max. 1000 m/cable drum
Increment:	1 m 1 m ... 1000 m

SC duplex plug, IP20	B-FOC (ST®) plug, IP20	LC plug
		
SCDUP	BFOC	LC
Ordering data	Ordering data	Ordering data
Order No.	Order No.	Order No.

Variable 2901559	Variable 2901559	Variable 2901559
Variable 2901559	Variable 2901559	Variable 2901559

Variable 2901559	Variable 2901559	Variable 2901559
Variable 2901559	Variable 2901559	Variable 2901559

Variable 2901559	Variable 2901559	Variable 2901559
Variable 2901559	Variable 2901559	Variable 2901559

	Technical data
Cable data	
Cable abbreviation according to IEC 61977: 2010	AT-VQH(BN)2Y 2G50/125 2,5B600+0,7F1200
Fibers	Fiberglass, 50/125 µm
Attenuation, typical	2.5 dB/km
Outer sheath	
Material	PE
Color	black
Diameter	10 - 11 mm
Strain relief elements	Non-metallic, aramid fiber
Rodent protection	Glass fibers
Lengthwise waterproofing	IEC 60794-1-2
Individual wire	
Structure	FRNC material
Color	Red/Green
Diameter	2.9 mm ±0.1 mm
Strain relief elements	Non-metallic, aramid fibers
General data	
Weight	97 kg/km
Ambient temperature (operation)	-25 °C ... 70 °C
Ambient temperature (storage/transport)	-30 °C ... 70 °C
Ambient temperature (installation)	-5 °C ... 50 °C
Halogen-free as per:	According to IEC 60754-2

Fiber optics transmission

Fiber optics patch cables

For fast integration of fiber optic devices into existing fiber optic networks, it is best to use preassembled patch cables. Patch cables can be ordered in lengths of one, two, and five meters for the following plug formats: SCRJ, SC duplex, LC, and B-FOC (ST®). Both single and multi-mode fiberglass options are available.

Developed specifically for industrial applications, the preassembled patch cables feature a robust design. The strong outer cable sheath and plug transitions with bending protection sleeve mean that they can be safely used inside control cabinets.

The extremely robust patch cables are suitable for all fiber optic devices with an optical interface that supports single and/or multi-mode fiberglass.

Plugs:

- LC
- SC duplex
- SC-RJ
- B-FOC (ST®)

Fixed lengths:

- 1 m
- 2 m
- 5 m

Fiber types:

- Multi-mode fiberglass (MM)
- Single-mode fiberglass (SM)

Sheath colors:

- Multi-mode: Orange
- Single-mode: Yellow

Technical data:

- Halogen-free
- Flame-retardant
- No corrosive or toxic fumes
- External dimensions: 2.8 mm x 5.7 mm



LC plug

		Technical data		
Cable, properties		Individual wire diameter	2.8 mm	
Outer sheath, material		FRNC		
External sheath, strain relief elements		Non-metallic, aramid fiber		
Lateral pressure, long-term		60 N/cm		
Tensile strength short-term/long-term		600 N		
Halogen-free		According to IEC 60754-2		
General data				
Ambient temperature (storage/transport)		-25 °C ... 70 °C		
Ambient temperature (installation)		-5 °C ... 50 °C		
Ambient temperature (operation)		-5 °C ... 70 °C		
		Ordering data		
Description	Length of cable	Type	Order No.	Pcs. / Pkt.
FO patch cable with multi-mode fiberglass (OM2)				
- LC plug to LC, SC duplex, B-FOC or SC-RJ plug				
	1 m	FL MM PATCH 1,0 LC-LC	2989158	1
	2 m	FL MM PATCH 2,0 LC-LC	2989255	1
	5 m	FL MM PATCH 5,0 LC-LC	2901799	1
FO patch cable with multi-mode fiberglass (OM2)				
- SC duplex plug to SC duplex, B-FOC or SC-RJ plug				
	1 m			
	2 m			
	5 m			
FO patch cable with multi-mode fiberglass (OM2)				
- B-FOC plug to B-FOC or SC-RJ plug				
	1 m			
	2 m			
	5 m			
FO patch cable with multi-mode fiberglass (OM2)				
- SC-RJ plug to SC-RJ plug				
	1 m			
	2 m			
	5 m			
FO patch cable with single-mode fiberglass (OS1)				
- LC plug to LC, SC duplex or B-FOC plug				
	1 m	FL SM PATCH 1,0 LC-LC	2989187	1
	2 m	FL SM PATCH 2,0 LC-LC	2989284	1
	5 m	FL SM PATCH 5,0 LC-LC	2901826	1
FO patch cable with single-mode fiberglass (OS1)				
- SC duplex plug to SC duplex or B-FOC plug				
	1 m			
	2 m			
	5 m			
FO patch cable with single-mode fiberglass (OS1)				
- B-FOC plug to B-FOC plug				
	1 m			
	2 m			
	5 m			



SC duplex plug



B-FOC plug



SC-RJ plug

Technical data
2.8 mm
FRNC
Non-metallic, aramid fiber
60 N/cm
600 N
According to IEC 60754-2
-25 °C ... 70 °C
-5 °C ... 50 °C
-5 °C ... 70 °C

Technical data
2.8 mm
FRNC
Non-metallic, aramid fiber
60 N/cm
600 N
According to IEC 60754-2
-25 °C ... 70 °C
-5 °C ... 50 °C
-5 °C ... 70 °C

Technical data
2.8 mm
FRNC
Non-metallic, aramid fiber
60 N/cm
600 N
According to IEC 60754-2
-25 °C ... 70 °C
-5 °C ... 50 °C
-5 °C ... 70 °C

Ordering data		
Type	Order No.	Pcs. / Pkt.
FL MM PATCH 1,0 LC-SC	2989161	1
FL MM PATCH 2,0 LC-SC	2989268	1
FL MM PATCH 5,0 LC-SC	2901800	1
FL MM PATCH 1,0 SC-SC	2901805	1
FL MM PATCH 2,0 SC-SC	2901807	1
FL MM PATCH 5,0 SC-SC	2901808	1
FL SM PATCH 1,0 LC-SC	2989190	1
FL SM PATCH 2,0 LC-SC	2989297	1
FL SM PATCH 5,0 LC-SC	2901827	1
FL SM PATCH 1,0 SC-SC	2901829	1
FL SM PATCH 2,0 SC-SC	2901830	1
FL SM PATCH 5,0 SC-SC	2901831	1

Ordering data		
Type	Order No.	Pcs. / Pkt.
FL MM PATCH 1,0 LC-ST	2989174	1
FL MM PATCH 2,0 LC-ST	2989271	1
FL MM PATCH 5,0 LC-ST	2901801	1
FL MM PATCH 1,0 SC-ST	2901809	1
FL MM PATCH 2,0 SC-ST	2901810	1
FL MM PATCH 5,0 SC-ST	2901811	1
FL MM PATCH 1,0 ST-ST	2901815	1
FL MM PATCH 2,0 ST-ST	2901816	1
FL MM PATCH 5,0 ST-ST	2901817	1
FL SM PATCH 1,0 LC-ST	2989242	1
FL SM PATCH 2,0 LC-ST	2989349	1
FL SM PATCH 5,0 LC-ST	2901828	1
FL SM PATCH 1,0 SC-ST	2901832	1
FL SM PATCH 2,0 SC-ST	2901833	1
FL SM PATCH 5,0 SC-ST	2901834	1
FL SM PATCH 1,0 ST-ST	2901836	1
FL SM PATCH 2,0 ST-ST	2901837	1
FL SM PATCH 5,0 ST-ST	2901838	1

Ordering data		
Type	Order No.	Pcs. / Pkt.
FL MM PATCH 1,0 LC-SCRJ	2901802	1
FL MM PATCH 2,0 LC-SCRJ	2901803	1
FL MM PATCH 5,0 LC-SCRJ	2901804	1
FL MM PATCH 1,0 SC-SCRJ	2901812	1
FL MM PATCH 2,0 SC-SCRJ	2901813	1
FL MM PATCH 5,0 SC-SCRJ	2901814	1
FL MM PATCH 1,0 ST-SCRJ	2901820	1
FL MM PATCH 2,0 ST-SCRJ	2901821	1
FL MM PATCH 5,0 ST-SCRJ	2901822	1
FL MM PATCH 1,0 SCRJ-SCRJ	2901823	1
FL MM PATCH 2,0 SCRJ-SCRJ	2901824	1
FL MM PATCH 5,0 SCRJ-SCRJ	2901825	1

Fiber optics transmission

Measurement technology for fiber optics

The PSM-FO-POWERMETER fiber optic measuring case is used for carrying out optical power measurements. It provides a straightforward method for determining path attenuations and the remaining system reserves in fiber optic transmission systems with 660 nm and 850 nm.

The case contains a power meter and all the necessary reference cables and couplings for checking polymer, HCS, and fiberglass paths with an F-SMA or B-FOC (ST®) connection. An optional set can be ordered for terminal devices with an SCRJ connection.

- Suitable for terminal devices with an F-SMA, B-FOC (ST®), and SCRJ connection
- Reference cables with polymer, HCS, and fiberglass

Insertion loss according to IEC 874-1 method 7:

- 1.5 dB ... 2 dB for all fibers



Universal fiber optics measuring case

Measuring instrument
Receiver
Wavelength
Measuring range
Accuracy
Resolution
Ambient temperature range

Technical data	
Large-format silicon element	
660 nm, 780 nm, 850 nm	
-70 dB ... 6 dB	
± 0.25 dB	
0.01 dB	
0 °C ... 45 °C	

Description
Fiber optic measuring case , comprising an optical power meter, F-SMA and B-FOC (ST®) coupling, reference fibers, and operating instructions
Powermeter supplementary set for devices with SC-RJ interface, comprising one-meter polymer reference fiber (SC Simplex plug to F-SMA plug), one-meter PCF GI reference fiber (SC Simplex plug to B-FOC (ST®) plug), and SC-RJ coupling

Ordering data		
Type	Order No.	Pcs. / Pkt.
PSM-FO-POWERMETER	2799539	1
PSM-FO-POWERMETER SCRJ-SET	2901560	1

Assembly case for quick mounting plug

The DIY cases for polymer and HCS cables are designed for practical on-site assembly. These cases contain the complete tool range for assembly of the appropriate quick mounting plugs.

Polymer fiber cables are assembled quickly and easily using the PSM-POF-KONFTOOL DIY case. The F-SMA or SCRJ plugs are used in this context.

Various PSM-HCS-KONFTOOL... tool sets are available for fitting plugs to the powerful HCS fibers, as the HCS fibers can be connected to F-SMA, B-FOC (ST®), SCRJ, and SC duplex plugs, depending on the application and device concerned. An individual fiber cleaving tool (cleave tool) is required for this due to the different plug receptacles.

Tool sets are occasionally available to rent at a low rate. Please contact us for an individual offer.



Assembly case for quick mounting plug

Description
Polymer fiber DIY Case , consisting of: Stripping knife, stripping pliers, polishing wheel for F-SMA and SC-RJ quick mounting plugs, polishing pad and emery paper
- For F-SMA plugs
- For B-FOC (ST®) plugs
- For SCRJ/SC duplex plugs

Ordering data		
Type	Order No.	Pcs. / Pkt.
PSM-POF-KONFTOOL	2744131	1
PSM-HCS-KONFTOOL	2799526	1
PSM-HCS-KONFTOOL/B-FOC	2708465	1
PSM-HCS-KONFTOOL/SC-RJ	2708876	1

Fiber cleaning tool for PCF fiber , pin arrangement F-SMA
Fiber cleaving tool for PCF (GI) fiber , pin arrangement B-FOC (ST®)
Fiber cleaving tool for PCF (GI) fiber , pin arrangement SC-RJ/SC duplex

Accessories		
Type	Order No.	Pcs. / Pkt.
PSM-HCS-CLEAVETOOL	2744995	1
PSM-HCS-CLEAVETOOL/B-FOC	2708478	1
PSM-HCS-CLEAVETOOL/SCRJ	2313122	1

Connectors and couplings for fiber optics

Quick mounting plugs for polymer fiber cable

These plugs are easy to assemble and allow fast and simple self-assembly on site. They correspond to the international F-SMA and SCRJ standards, although their quick mounting mechanism makes them stand out from conventional plugs. The stripped fiber is simply pushed into the plug and tightened with the knurled screw. To ensure optimum performance, the end face is then polished. The tools required are also available as a complete DIY case (PSM-POF-KONFTOOL).

Quick mounting plug for HCS (PCF) cables

The PSM-SET-...HCS plug sets for 200/230 µm fibers make it possible to enjoy the benefits of self-assembly for the kinds of distances that could otherwise only be achieved by using cables made purely from fiberglass. The F-SMA, B-FOC (ST®), SCRJ, and SC duplex plug types are internationally standardized, although their quick mounting mechanism makes them stand out from conventional plugs. All that is required is to strip the fibers, slide and screw on the plug, and cleave and break off the protruding fibers. All the tools required, including the fiber cleaving tool, are included in the PSM-HCS-KONFTOOL... tool set.

Couplings

Couplings are used to connect two FO plugs with the same pin arrangement. Couplings are used when a cable needs to be extended or when creating a non-permanent panel feed-through. However, the extra transitional attenuation (< 2 dB for all couplings) must be taken into consideration when planning the path resources. The sets include two F-SMA couplings or two B-FOC (ST®) couplings for connecting duplex cables. The SCRJ duplex, SC duplex, and LC couplings are supplied separately.



Quick mounting plugs for polymer and HCS(PCF) fibers, couplings

- Insertion attenuation
- F-SMA plug < 1.5 dB
 - B-FOC (ST®) - < 2 dB
 - SCRJ plug < 1.5 dB
 - SC duplex plug - < 2 dB

Description
Plug set for polymer fibers (diameter of the individual elements: 2.2 mm), for self-assembly, with bend protection
- F-SMA set, 4 plugs
- SCRJ set, 2 duplex plugs
Plug set for PCF fibers (diameter of the individual elements: 2.9 mm), for self-assembly, with bend protection
- F-SMA set, 4 plugs
- B-FOC (ST®) set, 4 plugs
- SCRJ set, 2 duplex plugs
Plug set for PROFINET PCF fibers (diameter of the individual elements: 2.2 mm), for self-assembly, with bend protection
- B-FOC (ST®) set, 4 plugs
- SCRJ set, 2 duplex plugs
- SC duplex set, 2 duplex plugs
Coupling ; set, consisting of:
- 2x F-SMA/F-SMA
- 2x B-FOC (ST®)/B-FOC (ST®)
- 1 x SC-RJ/SC-RJ (duplex)
- 1 x LC/LC (duplex, multi-mode fiber)
- 1 x LC/LC (duplex, single-mode fiber)
- 1x SC duplex/SC duplex

Polymer fiber polishing set for quick mounting plugs, comprising polishing pads and polishing disks	
- For F-SMA plugs	
- For SCRJ plugs	

Technical data	
Polymer fiber	HCS fiber
< 1.5 dB	< 2 dB
-	< 2 dB
< 1.5 dB	< 2 dB
-	< 2 dB

Ordering data		
Type	Order No.	Pcs. / Pkt.
PSM-SET-FSMA/4-KT	2799720	1
PSM-SET-SCRJ-DUP/2-POF	2708656	1
PSM-SET-FSMA/4-HCS	2799487	1
PSM-SET-B-FOC/4-HCS	2708481	1
PSM-SET-SCRJ-DUP/2-HCS	2313070	1
PSM-SET-B-FOC/4-HCS/PN	2313782	1
PSM-SET-SCRJ-DUP/2-HCS/PN	2313546	1
PSM-SET-SC-DUPLEX/2-HCS/PN	2313779	1
PSM-SET-FSMA-LINK/2	2799416	1
PSM-SET-BFOC-LINK/2	2799429	1
VS-SCRJ-GOF-BU/BU	1652978	1
FL MM PATCH COUPLER LC-LC	2700312	1
FL SM PATCH COUPLER LC-LC	2700313	1
FL COUPLER SC-DUPLEX	2901788	1

Accessories		
PSM-SET-FSMA-POLISH	2799348	1
VS-SCRJ-POF-POLISH	1656673	1

Permissible combinations of fiber optic cables and connector sets			
Fiber optic cable		Connector set	
2799885	PSM-LWL-HCS-RUGGED-200/230	2799487	PSM-SET-FSMA/4-HCS
2799445	PSM-LWL-HCSO-200/230	2708481	PSM-SET-B-FOC/4-HCS
		2313070	PSM-SET-SCRJ-DUP/2-HCS
2313410	FL FOC PN-C-HCS-GI-200/230	2313779	PSM-SET-SC-DUPLEX/2-HCS/PN
2313766	FL FOC PN-B-HCS-200/230	2313782	PSM-SET-B-FOC/4-HCS/PN
		2313546	PSM-SET-SCRJ-DUP/2-HCS/PN

Optical transmission with FO technology provides superior immunity to interference at maximum transmission ranges without restricting the transmission bandwidth.

General features

- 10/100 Mbps
- Auto negotiation and auto MDI/MDIX
- Connection monitoring with LFPT (link fault pass through)
- Signal LEDs for activity, link status, 10/100 Mbps
- Backplane bus contact (TBUS), enabling alternative or redundant 24 V power supply

Devices with 1300 nm wavelength

The FL MC EF 1300... media converters support universal use.

Features:

- 1300 nm wavelength
- Multi-mode or single-mode fiberglass cable
- B-FOC (ST®) or SC-DUPLEX

Devices with WDM technology

The FL MC EF WDM... media converters enable full duplex communication with a single fiberglass via WDM technology (Wavelength Division Multiplex).

Features:

- 1310 nm and 1550 nm wavelengths for transmitting and receiving
- Multi-mode or single-mode fiberglass cable
- SC simplex connection



Ethernet



WDM technology
Single-fiber transmission



Supply	
Supply voltage	
Supply voltage	
Nominal current consumption	
FO interface	
Wavelength	
Transmission length incl. 3 dB system reserve	
Signal LEDs	
Ethernet interface	
Connection method	
Transmission speed	
Auto-negotiation modes	
Transmission length	
Link through	
MDI-/MDI-X switchover	
Signal LEDs	
General data	
Ambient temperature (operation)	
Electrical isolation	
Test voltage	
Dimensions	W / H / D
Conformance / approvals	
ATEX	
UL, USA / Canada	

Technical data	
18 V DC ... 30 V DC (screw connection)	
18 V DC ... 30 V DC (as an alternative or redundant, via backplane bus contact and system current supply)	
< 110 mA (24 V DC)	
1310 nm / 1550 nm	
38 km (with F-E 9/125 0.36 dB/km)	
34 km (with F-E 9/125 0.4 dB/km)	
28 km (with F-E 9/125 0.5 dB/km)	
21 km (with F-G 62.5/125 0.7 dB/km F 1000)	
5.5 km (with F-G 62.5/125 2.6 dB/km F 600)	
21 km (with F-G 50/125 0.7 dB/km F 1200)	
9 km (with F-G 50/125 1.6 dB/km F 800)	
Far end fault (red LED), link status (yellow LED)	
RJ45 socket, shielded	
10/100 Mbps	
Auto	
100 m (twisted pair, shielded)	
Link fault pass through	
Auto-MDI(X)	
Activity, link status, 10/100 Mbps	
-40 °C ... 65 °C	
VCC // FE // Ethernet	
1.5 kV _{rms} (50 Hz, 1 min.)	
22.5 mm / 99 mm / 114.5 mm	
Ex II 3 G Ex nA IIC T4 Gc X	
cULus listed UL 508	
Class I, Zone 2, AEx nA IIC T4	
Class I, Zone 2, Ex nA IIC T4 Gc X	
Class I, Div. 2, Groups A, B, C, D	

Description
FO converter , for converting 10/100 BASE-TX to a single-mode optical fiber, WDM technology
WDM set with devices A and B, SC simplex connection
WDM device A, SC simplex connection
WDM device B, SC simplex connection
FO converter , for converting 10/100 BASE-TX to:
Multi-mode fiberglass (1300 nm), SC duplex connection
Multi-mode fiberglass (1300 nm), B-FOC (ST®) connection
FO converter , for converting 10/100 BASE-TX to:
Single-mode fiberglass (1300 nm), SC duplex connection

Ordering data		
Type	Order No.	Pcs. / Pkt.
FL MC EF WDM-SET SC	2902660	1
FL MC EF WDM-A SC	2902658	1
FL MC EF WDM-B SC	2902659	1



Ethernet



Universal devices with 1300 nm for multi-mode fiberglass



Ethernet



Universal device with 1300 nm for single-mode fiberglass



Technical data

18 V DC ... 30 V DC (screw connection)
18 V DC ... 30 V DC (as an alternative or redundant, via backplane bus contact and system current supply)

< 100 mA (24 V DC)

1300 nm
6.4 km (with F-G 50/125 0,7 dB/km F 1000)
2.8 km (with F-G 50/125 1,6 dB/km F 800)
10 km (with F-G 62.5/125 0,7 dB/km F 1000)
3 km (with F-G 62.5/125 2,6 dB/km F 600)
2 km (with 2GK200/230 GI-HCS)

Far end fault (red LED), link status (yellow LED)

RJ45 socket, shielded
10/100 Mbps
Auto
100 m (twisted pair, shielded)
Link fault pass through
Auto-MDI(X)
Activity, link status, 10/100 Mbps

-40 °C ... 65 °C
VCC // FE // Ethernet
1.5 kV_{rms} (50 Hz, 1 min.)
22.5 mm / 99 mm / 114.5 mm

Ex II 3 G Ex nA IIC T4 Gc X
Ex II (2) D [Ex op is Db] IIIC (PTB 06 ATEX 2042 U)
Ex II (2) G [Ex op is Gb] IIC (PTB 06 ATEX 2042 U)
cULus listed UL 508
Class I, Zone 2, AEx nA IIC T4
Class I, Zone 2, Ex nA IIC T4 Gc X
Class I, Div. 2, Groups A, B, C, D

Ordering data

Type	Order No.	Pcs. / Pkt.
FL MC EF 1300 MM SC	2902853	1
FL MC EF 1300 MM ST	2902854	1

Technical data

18 V DC ... 30 V DC (screw connection)
18 V DC ... 30 V DC (as an alternative or redundant, via backplane bus contact and system current supply)

< 100 mA (24 V DC)

1300 nm
36 km (with F-E 9/125 0.36 dB/km)
32 km (with F-E 9/125 0.4 dB/km)
26 km (with F-E 9/125 0.5 dB/km)

Far end fault (red LED), link status (yellow LED)

RJ45 socket, shielded
10/100 Mbps
Auto
100 m (twisted pair, shielded)
Link fault pass through
Auto-MDI(X)
Activity, link status, 10/100 Mbps

-40 °C ... 65 °C
VCC // FE // Ethernet
1.5 kV_{rms} (50 Hz, 1 min.)
22.5 mm / 99 mm / 114.5 mm

Ex II 3 G Ex nA IIC T4 Gc X
cULus listed UL 508
Class I, Zone 2, AEx nA IIC T4
Class I, Zone 2, Ex nA IIC T4 Gc X
Class I, Div. 2, Groups A, B, C, D

Ordering data

Type	Order No.	Pcs. / Pkt.
FL MC EF 1300 SM SC	2902856	1

Media converters

The class 1000 and 2000 media converters offer a robust design in metal housing. From the basic version to use in energy applications, they meet a wide range of different requirements.

General features

- 1300 nm wavelength
- 10/100 Mbps
- Connection monitoring with LFPT (link fault pass through)
- Signal LEDs for activity, link status, 10/100 Mbps
- Robust design in metal housing for high EMC requirements

Devices for basic requirements

The FL MC 1000... media converters offer an easy and inexpensive entry-level solution for converting to FO technology.

Features:

- Multi-mode or single-mode fiberglass cable
- B-FOC (ST®) or SC-DUPLEX
- Auto negotiation and auto MDI/MDIX

Devices for realtime applications

Thanks to their short delay times (latency), the **FL MC 2000T...** media converters are suitable for applications with realtime Ethernet protocols.

Features:

- Store-and-forward or pass-through mode can be selected via DIP switch (low latency, 835 ns)
- Multi-mode or single-mode fiberglass cable
- B-FOC (ST®) or SC-DUPLEX
- Wide operating temperature range (-40°C...+75°C)

Devices for harsh requirements

The **FL MC 2000E...** media converters are designed for use in energy technology. Thanks to their robust design, they are used in environments subject to high levels of EMI around switchgear.

Features:

- Multi-mode or single-mode fiberglass cable
- LC duplex connection
- IEC 61850 and IEEE 1613
- Wide operating temperature range (-40°C...+75°C)
- Redundant power supply with a wide range from 12 ... 57 V DC (24, 36, 48 V DC)



new

Basic requirements, multi-mode fiberglass

Supply	
Supply voltage	12 V DC ... 48 V DC
Nominal current consumption	73 mA (24 V DC)
FO interface	
Wavelength	1310 nm
Transmission length incl. 3 dB system reserve	8 km (fiberglass with F-G 62.5/125 0.7 dB/km F1000) 3.3 km (fiberglass with F-G 62.5/125 2.6 dB/km F600) 9.6 km (fiberglass with F-G 50/125 0.7 dB/km F1200) 5.3 km (fiberglass with F-G 50/125 1.6 dB/km F800) 2 km (HCS GI fiber with F-GK 200/230)
Signal LEDs	LNK/ACT
Ethernet interface	
Connection method	RJ45 socket, shielded
Transmission speed	10/100 Mbps
Link through	Link fault pass through
MDI-/MDI-X switchover	Auto-MDI(X)
Signal LEDs	LNK/ACT, 100
Switching output	
Contact type	-
Max. switching voltage	-
General data	
Ambient temperature (operation)	0 °C ... 60 °C
Electrical isolation	VCC // FE // Ethernet
Test voltage	500 V DC
Dimensions	28 mm / 110 mm / 70 mm

Technical data		
Supply		
12 V DC ... 48 V DC		
73 mA (24 V DC)		
FO interface		
1310 nm		
8 km (fiberglass with F-G 62.5/125 0.7 dB/km F1000)		
3.3 km (fiberglass with F-G 62.5/125 2.6 dB/km F600)		
9.6 km (fiberglass with F-G 50/125 0.7 dB/km F1200)		
5.3 km (fiberglass with F-G 50/125 1.6 dB/km F800)		
2 km (HCS GI fiber with F-GK 200/230)		
Signal LEDs		
LNK/ACT		
Ethernet interface		
RJ45 socket, shielded		
10/100 Mbps		
Link fault pass through		
Auto-MDI(X)		
LNK/ACT, 100		
Switching output		
-		
-		
General data		
0 °C ... 60 °C		
VCC // FE // Ethernet		
500 V DC		
28 mm / 110 mm / 70 mm		

Description
FO converter , for converting 10/100 BASE-TX to:
Multi-mode fiberglass (1300 nm), SC duplex connection
Multi-mode fiberglass (1300 nm), B-FOC (ST®) connection
Multi-mode fiberglass (1300 nm), LC duplex connection
FO converter , for converting 10/100 BASE-TX to:
Single-mode fiberglass (1300 nm), SC duplex connection
Single-mode fiberglass (1300 nm), SC duplex connection
Single-mode fiberglass (1300 nm), LC duplex connection

Ordering data		
Type	Order No.	Pcs. / Pkt.
FL MC 1000 SC	2891320	1
FL MC 1000 ST	2891321	1

Ethernet



Realtime protocols,
multi-mode fiberglass

Ethernet



Realtime protocols,
single-mode fiberglass

Ethernet



IEC 61850-3

Harsh ambient conditions, IEC 61850

Technical data
12 V DC ... 48 V DC 110 mA (24 V DC)
1310 nm 8 km (fiberglass with F-G 62.5/125 0.7 dB/km F1000) 3.3 km (fiberglass with F-G 62.5/125 2.6 dB/km F600) 9.6 km (fiberglass with F-G 50/125 0.7 dB/km F1200) 5.3 km (fiberglass with F-G 50/125 1.6 dB/km F800) 2 km (HCS GI fiber with F-GK 200/230)
LNK/ACT
RJ45 socket, shielded 10/100 Mbps Link fault pass through Auto-MDI(X) LNK/ACT, 100
1 x N/C contact ≤ 250 V AC
-40 °C ... 75 °C VCC // FE // Ethernet 500 V DC 28 mm / 110 mm / 70 mm

Technical data
12 V DC ... 48 V DC 110 mA (24 V DC)
1310 nm 20 km (fiberglass with F-G 9/125 0.36 dB/km)
LNK/ACT
RJ45 socket, shielded 10/100 Mbps Link fault pass through Auto-MDI(X) LNK/ACT, 100
1 x N/C contact ≤ 250 V AC
-40 °C ... 75 °C VCC // FE // Ethernet 500 V DC 28 mm / 110 mm / 70 mm

Technical data
12 V DC ... 57 V DC 110 mA (24 V DC)
1310 nm 8 km (fiberglass with F-G 62.5/125 0.7 dB/km F1000) 3.3 km (fiberglass with F-G 62.5/125 2.6 dB/km F600) 9.6 km (fiberglass with F-G 50/125 0.7 dB/km F1200) 5.3 km (fiberglass with F-G 50/125 1.6 dB/km F800) 2 km (HCS GI fiber with F-GK 200/230)
LNK/ACT
RJ45 socket, shielded 100 Mbps Link fault pass through Auto-MDI(X) LNK/ACT, 100
1 x N/C contact ≤ 250 V AC
-40 °C ... 75 °C VCC // FE // Ethernet 500 V DC 30 mm / 130 mm / 100 mm

Ordering data		
Type	Order No.	Pcs. / Pkt.
FL MC 2000T SC	2891315	1
FL MC 2000T ST	2891316	1

Ordering data		
Type	Order No.	Pcs. / Pkt.
FL MC 2000T SM20 SC	2891317	1
FL MC 2000T SM40 SC	2891318	1

Ordering data		
Type	Order No.	Pcs. / Pkt.
FL MC 2000E LC	2891056	1
FL MC 2000E SM40 LC	2891156	1

Device servers for converting serial interfaces



The **FL COMSERVER...232/422/485** products are used to integrate serial RS-232/RS-422/RS-485 interfaces into existing Ethernet networks. This provides an easy way of implementing functions such as cable replacement, network integration or a Modbus gateway.

Cable replacement

Two devices in combination tunnel serial connections via Ethernet, using either the TCP or UDP protocol.

Network integration

You can integrate automation devices such as controllers or frequency inverters into a network using corresponding programming and diagnostics software. COM diversion software creates a virtual COM port on the PC and transmits the data to the FL COMSERVER.

Modbus gateway

The integrated Modbus gateway function provided in FL COMSERVER UNI converts serial Modbus ASCII or RTU data into Modbus TCP. Naturally, the conversion process also works in the opposite direction.

Features common to all devices:

- Serial interfaces: RS-232, RS-422, RS-485
- 10/100 Base-T(X) interface
- Software for virtual COM ports supplied as standard
- Extended temperature range of -25°C to +60°C
- Redundant power supply and modular station configuration with DIN rail connectors
- 3-way electrical isolation VCC // RS-232/RS-422/RS-485 // network
- Integration into network management tools and visualization systems with the support of SNMP services
- LED diagnostics indicators
- Configuration via web-based management

FL COMSERVER UNI...

- Supports TCP, UDP, Modbus TCP/RTU/ASCII
- Can be used exactly as required on Modbus master or slave

FL COMSERVER BASIC...

- Best-value version
- Supports TCP and UDP

Supply	
Supply voltage	
Supply voltage	
Nominal current consumption	
Serial port	
Interfaces	
Connection method	RS-232 RS-422 RS-485
Data format/coding	
Data flow control/protocols	
Transmission speed	
Termination resistor	
Ethernet interface	
Connection method	
Transmission speed	
Transmission length	
Supported protocols	
Auxiliary protocols	
Functions	
Management	
General data	
Ambient temperature (operation)	
Electrical isolation	
Test voltage	
Electromagnetic compatibility	
Dimensions	W / H / D
Conformance / approvals	
UL, USA / Canada	

Description	
FL COMSERVER...232/422/485 , for converting serial interfaces to Ethernet. COM port redirector software and additional software supplied as standard	
TCP, UDP, MODBUS, PPP TCP, UDP	

RS-232-D-SUB cable , length: 2 m	
- 9-pos. socket on 9-pos. socket	
- 9-pos. socket on 25-pos. socket	
DIN rail connector	
System power supply , primary-switched	



Ethernet



Universal device - Modbus gateway between RTU/ASCII and TCP



Ethernet



Basic version for redirector operation - TCP and UDP



Ethernet



With extended temperature and supply voltage range



Technical data

19.2 V AC/DC ... 28.8 V AC/DC (via plug-in COMBICON screw terminal block)
22.8 V DC ... 25.2 V DC (as an alternative or redundant, via backplane bus contact and system current supply)

100 mA (24 V DC)

RS-232, RS-422, RS-485
D-SUB-9 plug
Plug-in/screw connection via COMBICON
Plug-in/screw connection via COMBICON
UART/NRZ: 7/8 bit data, 1/2 bit stop, None/Even/Odd Parity

Software handshake, Xon/Xoff, or hardware handshake RTS/CTS // 3964 R compatible, Modbus RTU/ASCII

0.3; 0.6; 1.2; 2.4; 4.8; 7.2; 9.6; 19.2; 38.4; 57.6; 115.2; 187.5; 230.4 kbps
390 Ω / 180 Ω / 390 Ω (configurable)

RJ45 socket, shielded
10/100 Mbps, auto negotiation
≤ 100 m (shielded twisted pair)
TCP/IP, UDP, Modbus (TCP, RTU/ASCII), PPP
ARP, DHCP, BOOTP, SNMP, RIP, RARP, HTTP, TFTP

Web-based management, SNMP, emergency exit with Telnet and serial

-25 °C ... 60 °C

DIN EN 50178 (VCC // Ethernet // Serial)
1.5 kV_{ms} (50 Hz, 1 min.)
Conformance with EMC Directive 2004/108/EC
22.5 mm / 99 mm / 116 mm

508 listed
Class I, Div. 2, Groups A, B, C, D

Technical data

19.2 V AC/DC ... 28.8 V AC/DC (via plug-in COMBICON screw terminal block)
22.8 V DC ... 25.2 V DC (as an alternative or redundant, via backplane bus contact and system current supply)

100 mA (24 V DC)

RS-232, RS-422, RS-485
D-SUB-9 plug
Plug-in/screw connection via COMBICON
Plug-in/screw connection via COMBICON
UART/NRZ: 7/8 bit data, 1/2 bit stop, None/Even/Odd Parity

Software handshake, Xon/Xoff or hardware handshake RTS/CTS

0.3; 0.6; 1.2; 2.4; 4.8; 7.2; 9.6; 19.2; 38.4; 57.6; 115.2; 187.5; 230.4 kbps
390 Ω / 180 Ω / 390 Ω

RJ45 socket, shielded
10/100 Mbps, auto negotiation
≤ 100 m (shielded twisted pair)
TCP/IP, UDP
ARP, DHCP, BOOTP, SNMP, RIP, RARP, HTTP, TFTP

Web-based management, SNMP, emergency exit with Telnet and serial

-25 °C ... 60 °C

DIN EN 50178 (VCC // Ethernet // Serial)
1.5 kV_{ms} (50 Hz, 1 min.)
Conformance with EMC Directive 2004/108/EC
22.5 mm / 99 mm / 116 mm

508 listed
Class I, Div. 2, Groups A, B, C, D

Technical data

12 V AC/DC ... 30 V AC/DC (observe derating)

-

100 mA (24 V DC)

RS-232, RS-422, RS-485
D-SUB-9 plug
Plug-in/screw connection via COMBICON
Plug-in/screw connection via COMBICON
UART/NRZ: 7/8 bit data, 1/2 bit stop, None/Even/Odd Parity

Software handshake, Xon/Xoff, or hardware handshake RTS/CTS // 3964 R compatible, Modbus RTU/ASCII

0.3; 0.6; 1.2; 2.4; 4.8; 7.2; 9.6; 19.2; 38.4; 57.6; 115.2; 187.5; 230.4 kbps
390 Ω / 180 Ω / 390 Ω (configurable)

RJ45 socket, shielded
10/100 Mbps, auto negotiation
≤ 100 m (shielded twisted pair)
TCP/IP, UDP, Modbus (TCP, RTU/ASCII), PPP
ARP, DHCP, BOOTP, SNMP, RIP, RARP, HTTP, TFTP

Web-based management, SNMP, emergency exit with Telnet and serial

-40 °C ... 70 °C (free-standing, 40mm space on all sides)

DIN EN 50178 (VCC // Ethernet // Serial)
1.5 kV_{ms} (50 Hz, 1 min.)
Conformance with EMC Directive 2004/108/EC
45 mm / 99 mm / 116 mm

-

Ordering data

Type	Order No.	Pcs. / Pkt.
FL COMSERVER UNI 232/422/485	2313452	1

Ordering data

Type	Order No.	Pcs. / Pkt.
FL COMSERVER BASIC 232/422/485	2313478	1

Ordering data

Type	Order No.	Pcs. / Pkt.
FL COMSERVER UNI 232/422/485-T	2904817	1
FL COMSERVER BAS 232/422/485-T	2904681	1

Accessories

Accessories	Order No.	Pcs. / Pkt.
PSM-KA9SUB9/BB/2METER	2799474	1
PSM-KA 9 SUB 25/BB/2METER	2761059	1
ME 22,5 TBUS 1,5/ 5-ST-3,81 GN	2707437	50
MINI-SYS-PS-100-240AC/24DC/1.5	2866983	1

Accessories

Accessories	Order No.	Pcs. / Pkt.
PSM-KA9SUB9/BB/2METER	2799474	1
PSM-KA 9 SUB 25/BB/2METER	2761059	1
ME 22,5 TBUS 1,5/ 5-ST-3,81 GN	2707437	50
MINI-SYS-PS-100-240AC/24DC/1.5	2866983	1

Accessories

Accessories	Order No.	Pcs. / Pkt.
PSM-KA9SUB9/BB/2METER	2799474	1
PSM-KA 9 SUB 25/BB/2METER	2761059	1
ME 22,5 TBUS 1,5/ 5-ST-3,81 GN	2707437	50
MINI-SYS-PS-100-240AC/24DC/1.5	2866983	1

4 kV Ethernet ISOLATOR for electrical isolation

The **FL ISOLATOR** is used for electrical isolation in copper-based Ethernet networks.

In industrial environments, potential differences pose a constant problem with regard to interference-free data transmission.

The high-quality isolation for up to 4 kV provides reliable protection for Ethernet devices and interfaces. This results in considerably higher immunity to interference in industrial applications.

The **FL ISOLATOR 100-M12** has been specifically developed for use in the railway industry. Featuring M12 connection technology and optional wall mounting, this network isolator can be used flexibly.

Features:

- Electrical isolation of data cables and cable shielding
- Electric strength up to 4 kV
- Transmission speed of up to 1000 Mbps, device-specific
- No power supply required
- Protection against aggressive environmental influences, particularly harsh industrial environments, thanks to coated PCB
- Approval for railway applications (rolling stock) according to EN 50155 and EN 50121
- Extended temperature range

Ethernet

PROFINET

Modbus



Transmission speeds up to 1 Gbps, two RJ45 connections



Ethernet interface	
Connection method	RJ45 socket, shielded
Transmission speed	10/100/1000 Mbps
Transmission length	≤ 100 m (total length across both ports (dependent on data rate and cable used))
General data	
Ambient temperature (operation)	-25 °C ... 75 °C
Electrical isolation	
Test voltage	Ethernet // Ethernet
Electromagnetic compatibility	4 kV AC (50 Hz, 1 min.)
Standards/regulations	Conformance with EMC Directive 2004/108/EC EN 50121 and EN 50155 (for railway applications)
Dimensions	W / H / D 22.5 mm / 99 mm / 92 mm
Conformance / approvals	508 listed
UL, USA / Canada	

Description	
Passive network isolator , for electrical isolation in Ethernet networks. For protection against potential differences of up to 4 kV.	
- For transmission speeds of up to 1 Gbps, connection: 2x RJ45 sockets	
- For transmission speeds of up to 100 Mbps, connection: 2x RJ45 sockets	
- For transmission speeds of up to 100 Mbps, connection: 1x RJ45 socket and COMBICON plug-in screw terminal block	
Passive network isolator , for electrical isolation in Ethernet networks. For protection against potential differences of up to 4 kV.	
- For transmission speeds of up to 100 Mbps, connection: two M12 sockets (D-coded)	
- With pre-installed adapter for mounting on a DIN rail	

Technical data	
RJ45 socket, shielded	
10/100/1000 Mbps	
≤ 100 m (total length across both ports (dependent on data rate and cable used))	
-25 °C ... 75 °C	
Ethernet // Ethernet	
4 kV AC (50 Hz, 1 min.)	
Conformance with EMC Directive 2004/108/EC	
EN 50121 and EN 50155 (for railway applications)	
22.5 mm / 99 mm / 92 mm	
508 listed	

Ordering data		
Type	Order No.	Pcs. / Pkt.
FL ISOLATOR 1000-RJ/RJ	2313915	1

Ethernet



Transmission speeds up to 100 Mbps
Two RJ45 connections

Ethernet



Transmission speeds up to 100 Mbps
RJ45 and screw connection

Ethernet



Transmission speeds up to 100 Mbps
M12 connection



Technical data
RJ45 socket, shielded
10/100 Mbps
≤ 100 m (Total length across both ports (dependent on data rate and cable used))
-25 °C ... 75 °C
Ethernet // Ethernet
4 kV AC (50 Hz, 1 min.)
Conformance with EMC Directive 2004/108/EC
EN 50121 and EN 50155 (for railway applications)
22.5 mm / 99 mm / 92 mm
508 listed

Technical data
RJ45 socket, shielded
10/100 Mbps
≤ 100 m (Total length across both ports (dependent on data rate and cable used))
-25 °C ... 75 °C
Ethernet // Ethernet
4 kV AC (50 Hz, 1 min.)
Conformance with EMC Directive 2004/108/EC
EN 50121 and EN 50155 (for railway applications)
22.5 mm / 99 mm / 92 mm
508 listed

Technical data
M 12 connectors (D-coded, socket)
10/100 Mbps
≤ 100 m (Total length across both ports (dependent on data rate and cable used))
-40 °C ... 75 °C (85°C for 10 min.; thereafter function can no longer be guaranteed - check device)
Port X1//port X2
4 kV AC (50 Hz, 1 min.)
Conformance with EMC Directive 2004/108/EC
EN 50121 and EN 50155 (for railway applications), IEC 60571, DIN EN 50153
66 mm / 91 mm / 34 mm
-

Ordering data		
Type	Order No.	Pcs. / Pkt.
FL ISOLATOR 100-RJ/RJ	2313931	1

Ordering data		
Type	Order No.	Pcs. / Pkt.
FL ISOLATOR 100-RJ/SC	2313928	1

Ordering data		
Type	Order No.	Pcs. / Pkt.
FL ISOLATOR 100-M12	2902985	1
FL ISOLATOR 100-M12 RMS	2904671	1

Passive patch panel for the DIN rail

The mini patch panels provide a convenient alternative to on-site assembly of RJ45 connectors.

The cross-control-cabinet field cabling is simply connected to screw, spring-cage or LSA connection terminal blocks, depending on which option is selected. The connection to the terminal devices is then completed using pre-assembled RJ45 patch cables.

General features

- CAT5e
- 10/100/1000 Mbps
- Mounted on DIN rails
- Safe shield connection to ground potential

FL CAT 5 TERMINAL BOX

- Screw terminal blocks
- 4-pin assignment: 1, 2, 3, 6
- Clearly labeled with PROFINET cable colors

FL-PP-RJ45-...

- Spring-cage connection terminal blocks
- Screw terminal blocks
- LSA connection terminal blocks
- 8-pin assignment: 1:1
- Option of shield contacting on DIN rail directly or via RC element with jumper

FL-PP-RJ45/RJ45

- Two RJ45 sockets
- 8-pin assignment: 1:1
- Version B as basic version with compact design and extended temperature range

FL-PP-RJ45-SCC/...

- Y-splitter for transmission of two individual network connections with 10/100 Mbps or phone line via a CAT cable with eight wires
- Spring-cage connection terminal blocks
- Option of shield contacting on DIN rail directly or via RC element with jumper

Notes:
Mini patch panel with electrical isolation, see page 386
For Ethernet cables and corresponding crimping pliers, see page 390
For RJ45 patch cables, see page 391

Ethernet

PROFINET

Modbus



1 x RJ45 to four connection terminal blocks, up to 100 Mbps

ERC

Technical data

General data	
Cable impedance	
Transmission speed	
Connection line	
Transmission length	
Plug connection	
Insertion/withdrawal cycles	
Cable cross section (max./min.)	
Screw connection solid / stranded / AWG	
Ambient temperature (operation)	
Dimensions	W / H / D

100 Ω
10/100 Mbps
twisted pair, shielded, CAT5 or better
100 m (including patch cables)
RJ45 CAT5e
≤ 2500
10 mm / 6 mm
0.14 - 1.5 mm ² / 0.14 - 1 mm ² / 26 - 16
-25 °C ... 70 °C
25 mm / 90 mm / 52 mm

Ordering data

Description
Patch panel, one RJ45 socket to 4 screw connection terminal blocks (assignment 1, 2, 3, 6), CAT5, 10/100 Mbps, DIN rail mounting, IP20, shield contacting on DIN rail
Patch panel, one RJ45 socket to 8 connection terminal blocks (1:1 assignment), CAT5e, 10/100/1000 Mbps, DIN rail mounting, IP20, option of shield contacting on DIN rail via jumpers
- RJ45 to spring-cage connection terminal blocks - RJ45 to screw connection terminal blocks - RJ45 to LSA connection terminal blocks
Patch panel, two RJ45 sockets (1:1 assignment), CAT5, 10/100/1000 Mbps, DIN rail mounting, IP20, option of shield contacting on DIN rail via jumpers
Patch panel, two RJ45 sockets (1:1 assignment), extended temperature range , CAT5, 10/100 Mbps, DIN rail mounting, IP20, consistent shield, width 22.5 mm
Cable sharing module , two RJ45 sockets with Ethernet assignment, to 8 spring-cage connection terminal blocks, CAT5e, 10/100 Mbps, DIN rail mounting, IP20, option of shield contacting on DIN rail via jumpers
- Cable outlet at the front, width 52 mm - Cable outlet at the top, width 56 mm

Type	Order No.	Pcs. / Pkt.
FL CAT5 TERMINAL BOX	2744610	1

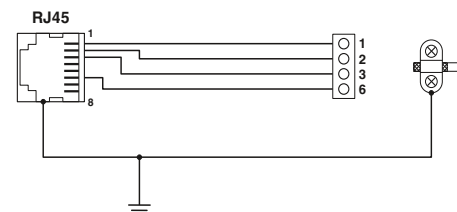



Ethernet

PROFIBUS
NET

Modbus

1 x RJ45 to eight connection terminal blocks, up to 1000 Mbps

Ethernet

PROFIBUS
NET

Modbus

2x RJ45



Ethernet

PROFIBUS
NET

Modbus

2 x RJ45 to eight connection terminal blocks, Y-splitter

Ex:

Ex:

Technical data
100 Ω
10/100/1000 Mbps
twisted pair, shielded, CAT5 or better
100 m (including patch cables)
RJ45 CAT5e
≤ 2500
10 mm / 6 mm
0.2 - 1.5 mm ² / 0.2 - 1 mm ² / 24 - 16
-25 °C ... 70 °C
29 mm / 90 mm / 53 mm

Technical data	
FL-PP-RJ45/RJ45	FL-PP-RJ45/RJ45-B
10/100/1000 Mbps	10/100 Mbps
twisted pair, shielded, CAT5 or better	twisted pair, shielded, CAT5 or better
100 m (including patch cables)	100 m (including patch cables)
RJ45 CAT5e	RJ45 CAT5
≤ 2500	≤ 2500
-25 °C ... 70 °C	-40 °C ... 85 °C
29 mm / 90 mm / 53 mm	22.5 mm / 78 mm / 44 mm

Technical data
100 Ω
10/100 Mbps
twisted pair, shielded, CAT5 or better
100 m (including patch cables)
RJ45 CAT5e
≤ 750
10 mm / 6 mm
0.2 - 1.5 mm ² / 0.2 - 1 mm ² / 24 - 16
-10 °C ... 50 °C
52 mm / 90 mm / 51 mm

Ordering data		
Type	Order No.	Pcs. / Pkt.
FL-PP-RJ45-SCC	2901642	1
FL-PP-RJ45-SC	2901643	1
FL-PP-RJ45-LSA	2901645	1

Ordering data		
Type	Order No.	Pcs. / Pkt.
FL-PP-RJ45/RJ45	2901646	1
FL-PP-RJ45/RJ45-B	2904933	10

Ordering data		
Type	Order No.	Pcs. / Pkt.
FL-PP-RJ45-SCC/SC041	2903532	1
FL-PP-RJ45-SCC/SC045	2904577	1

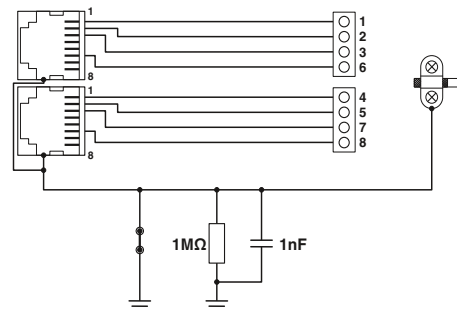
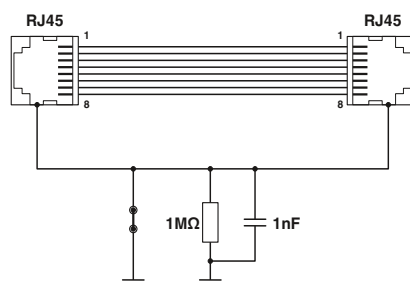
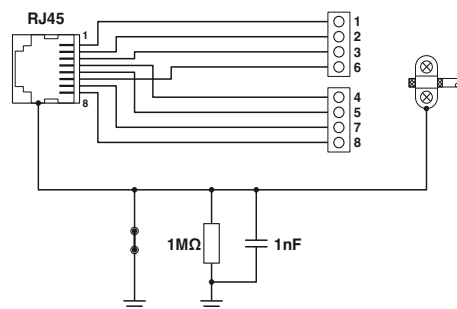

Ethernet cables, plugs, tools

The Ethernet cables of category 5e (up to 125 Mbps) which have been developed especially for industrial applications round off the range to form a complete industrial installation concept.

FL CAT 5 HEAVY...

The installation cable **FL CAT 5 HEAVY...** with solid twisted pair conductors, is particularly suitable for permanent installation outside the control cabinet or switch box. It is characterized by a highly durable second outer sheath made of polyurethane (PUR). With an external diameter of 7.5 mm, the cable has a high degree of mechanical load carrying capacity and fits perfectly through standard cable screw connections. Inside the control cabinet, the second outer sheath is simply removed (Ø 5.75 mm). The cable can thus be assembled directly with the RJ45 connector and connected to the modules. In line with CAT 5e, cable lengths up to 100 m are permissible.

FL CAT 5 FLEX...

The flexible and lightweight design **FL CAT5 FLEX...** is used for wiring inside the control cabinet (e.g. as patch cable between switch and terminal device). Flexible individual wires and a cable diameter of 5.75 mm facilitate installation where space is restricted. The permissible cable length with these highly flexible cables is 50 m.

Both cable types can be supplied ready assembled with RJ45 connector if required (see order sample).

Ethernet plugs and tools

The **FL PLUG...** plugs and matching crimping pliers are available for on-site assembly. The plugs comply with category 5e (up to 125 MHz) due to an extremely low cross-talk behavior. Therefore, the plugs can be used in 10/100 Mbps systems as well as in 1000Base-T-systems. For connections that are not crossed, it is recommended that you use the plug set (two plugs) with gray bend protection sleeve and for connections that are crossed, the plug set with green bend protection sleeve.

Ethernet

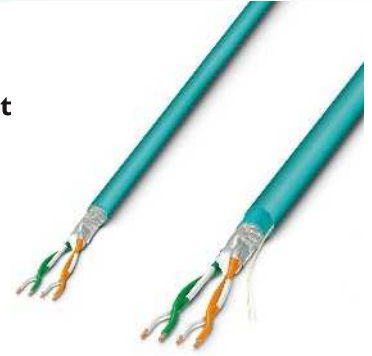

Ethernet-cable, 2-pair, CAT5/CAT5e in solid and stranded

Description	Ordering data		
	Type	Order No.	Pcs. / Pkt.
CAT5-SF/UTP cable (J-02YS(ST)C HP 2 x 2 x 24 AWG), heavy duty installation cable 2 x 2 x 0.22 mm ² , solid conductor, shielded, Outer sheath: 7.5 mm Ø ±0.3 mm Inner sheath: 5.75 mm Ø ±0.15 mm (length in meters as per customer specifications)	FL CAT5 HEAVY	2744814	1
CAT5-SF/UTP cable , same as before, however, assembled with RJ45 connector (refer to the order sample) on both sides	FL CAT5 HEAVY CONF/	2744827	1
CAT5-SF/UTP cable (J-LI02YS(ST)C H 2 x 2 x 26 AWG), light duty stranded installation cable 2 x 2 x 0.14 mm ² , fine strand conductor, shielded, Outer sheath: 5.75 mm Ø ±0.15 mm (length in meters as per customer specifications)	FL CAT5 FLEX	2744830	1
CAT5-SF/UTP cable , same as before, however, assembled with RJ45 connector (refer to the order sample) on both sides	FL CAT5 FLEX CONF/	2744843	1
RJ45 connector , shielded, with bend protection sleeve, x 2 - gray for straight cables - green for crossed cables Crimping pliers , for assembling the RJ45 connectors	Accessories		
	FL PLUG RJ45 GR/2	2744856	1
	FL PLUG RJ45 GN/2	2744571	1
	FL CRIMPTOOL	2744869	1

Ordering example for cable with connector

Light-weight and flexible installation cable, assembled with RJ45 connectors, crossover assignment, 3.5 m long

Quantity	Order No.	Connection	Length [m] ¹⁾
1	2744843	CO LI CO ≙ Crossover LI ≙ Line	3.5

¹⁾ min. 0.25 m
max. 50 m with FL CAT5 Flex
max. 100 m with FL CAT5 Heavy
step width: 0.25 m

Ordering example for cable with connector

Heavy-duty installation cable, 20 m long

Cable length	Order No.	Order designation
20	2744814	FL CAT5 HEAVY

In meters

RJ45 patch cables

Notes:
Additional accessories for network installation can be found in the "Ethernet networks" section on page 328

The preassembled patch cables have been specially developed for industrial use.

They are suitable for the quick installation of Ethernet components and patch fields or terminal devices within a control cabinet. They form the link to a seamless high quality Ethernet system.

The patch cables are characterized by a new bend protection and are available in graded lengths from 0.3 to 20 m.

All patch cables are designed as 1:1 cable. They come with four pairs of conductors and are assembled with RJ45 connectors according to IEC 603-7/class A. Each cable is tested separately for its transmission properties.

With their high, universal wiring quality across the active and passive infrastructure, the patch cables fulfill the requirements of the standards for CAT5/CAT6.

Ethernet



RJ45 patch cables for IP20 applications

Cable, properties	
External diameter	5.5 mm
Single wire, material	Cu litz wire
Individual wires per module	8
Single wire, cross section	0.14 mm ²
Outer sheath, material	LSFROH
Smallest bending radius, fixed installation	30 mm
Shielding	SF/UTP
Plug	
Contact resistance	≤ 0.003 Ω (IEC 60603-7)
General data	
Ambient temperature (operation)	-10 °C ... 60 °C

Technical data		
	FL CAT5 PATCH 0,3	FL CAT6 PATCH 0,3
External diameter	5.5 mm	5.5 mm
Single wire, material	Cu litz wire	Cu litz wire
Individual wires per module	8	8
Single wire, cross section	0.14 mm ²	0.14 mm ²
Outer sheath, material	LSFROH	LSFROH
Smallest bending radius, fixed installation	30 mm	30 mm
Shielding	SF/UTP	S/FTP
Contact resistance	≤ 0.003 Ω (IEC 60603-7)	≤ 0.003 Ω (IEC 60603-7)
Ambient temperature (operation)	-10 °C ... 60 °C	-10 °C ... 60 °C

Description	Length of cable
Patch cable, CAT5, preassembled	0.3 m
	0.5 m
	1 m
	1.5 m
	2 m
	3 m
	5 m
	7.5 m
	10 m
	Patch cable, CAT6, preassembled
0.5 m	
1 m	
1.5 m	
2 m	
3 m	
5 m	
7.5 m	
10 m	
12.5 m	
15 m	
20 m	

Ordering data			
Type	Order No.	Pcs. / Pkt.	
FL CAT5 PATCH 0,3	2832250	10	
FL CAT5 PATCH 0,5	2832263	10	
FL CAT5 PATCH 1,0	2832276	10	
FL CAT5 PATCH 1,5	2832221	10	
FL CAT5 PATCH 2,0	2832289	10	
FL CAT5 PATCH 3,0	2832292	10	
FL CAT5 PATCH 5,0	2832580	10	
FL CAT5 PATCH 7,5	2832616	10	
FL CAT5 PATCH 10,0	2832629	10	
FL CAT6 PATCH 0,3	2891181	10	
FL CAT6 PATCH 0,5	2891288	10	
FL CAT6 PATCH 1,0	2891385	10	
FL CAT6 PATCH 1,5	2891482	10	
FL CAT6 PATCH 2,0	2891589	10	
FL CAT6 PATCH 3,0	2891686	10	
FL CAT6 PATCH 5,0	2891783	10	
FL CAT6 PATCH 7,5	2891880	10	
FL CAT6 PATCH 10	2891877	10	
FL CAT6 PATCH 12,5	2891369	5	
FL CAT6 PATCH 15,0	2891372	5	
FL CAT6 PATCH 20,0	2891576	5	

Remote communication

Mobile communication/remote signaling and remote control system

Alarm and remote control via the mobile phone network

Use the mobile phone network, monitor analog and digital values, and switch relays remotely using the TC mobile I/O product range.

Depending on the product version, data is transmitted via SMS, e-mail, GPRS or ODP protocol.

Thanks to the large voltage range and the different inputs, the signaling system is suitable for use in a wide range of applications.

Features:

- Event-controlled or continual communication
- 4 digital inputs
- 2 analog inputs (current/voltage)
- 4 relay outputs, switchable via mobile phone
- Alarming in case of voltage failure via SMS
- Configuration via USB and web browser
- Standard SIM card
- Compact design: 4 pitches (DIN 43880)
- Cover can be sealed
- Numerous helpful software functions

Applications:

- Machine, building and system monitoring
- Pumps, sewage treatment plants, water supply
- Light controllers, remote switching systems
- Lifts, doors
- Alarm and domestic engineering
- Climate and ventilation engineering
- Battery monitoring up to 60 V
- Railway applications according to EN 50121-4

Supply	
Supply voltage	10 V DC ... 60 V DC
Nominal current consumption	110 mA (24 V DC)
Stand-by current consumption	40 mA (stand by)
USB interface	
Connection method	USB 2.0
Transmission length	Mini-USB type B, 5-pos.
Mobile phone network	
Frequencies	850 MHz (2 W (EGSM)) / 900 MHz (2 W (EGSM)) / 1800 MHz (1 W (EGSM)) / 1900 MHz (1 W (EGSM))
Digital input	
Number of inputs	4
Analog input	
Number of inputs	2
Signal range	0 V DC ... 60 V DC / 0 mA ... 20 mA / 4 mA ... 20 mA (configurable)
Resolution	15 bit
Accuracy	± 0.1 %
Switching output	
Contact type	4 x N/O contact
Max. switching voltage	60 V
Limiting continuous current	6 A
General data	
Ambient temperature (operation)	-25 °C ... 70 °C (for derating, see technical documentation)
Approvals for countries	EU, other countries in preparation
Electromagnetic compatibility	Conformance with EMC Directive 2004/108/EC
Dimensions	72 mm / 90 mm / 62 mm
ATEX	W / H / D Ex II 3 G Ex nA nC IIC T4 Gc X

Description
Compact signaling system , for mobile phone networks, monitors inputs, switches relay outputs
- Analog and digital inputs
- Digital inputs

Multi-band antenna for UMTS and quad band GSM, with omnidirectional characteristic, 2 m antenna cable with SMA round connector, degree of protection: IP65, dimensions: 76 x 20 mm

Multiband antenna for external panel and external mast mounting for UMTS and quad-band GSM, with omnidirectional characteristics, 5 m antenna cable with SMA round connector

Antenna extension cable for UMTS and quad-band GSM, with SMA connector and SMA coupling
--

Antenna extension cable for UMTS and quad-band GSM, 10 m long, antenna cable with SMA connector and SMA coupling

Power supply unit , primary-switched
USB connecting cable (individual) for configuration

Surge protection for UMTS and quad-band GSM antenna, with SMA connector and SMA coupling

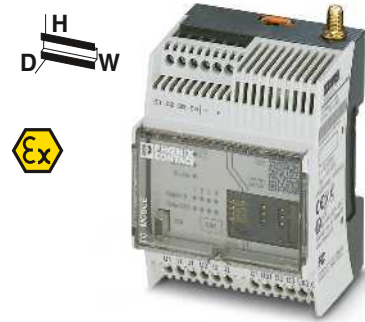

Communication via SMS and e-mail, 2 additional analog inputs



Technical data	
Supply	10 V DC ... 60 V DC
Nominal current consumption	110 mA (24 V DC)
Stand-by current consumption	40 mA (stand by)
USB interface	USB 2.0
Connection method	Mini-USB type B, 5-pos.
Transmission length	≤ 3 m (only for configuration and diagnostics)
Mobile phone network	850 MHz (2 W (EGSM)) / 900 MHz (2 W (EGSM)) / 1800 MHz (1 W (EGSM)) / 1900 MHz (1 W (EGSM))
Digital input	4
Analog input	2
Signal range	0 V DC ... 60 V DC / 0 mA ... 20 mA / 4 mA ... 20 mA (configurable)
Resolution	15 bit
Accuracy	± 0.1 %
Switching output	4 x N/O contact
Contact type	60 V
Max. switching voltage	6 A
Limiting continuous current	
General data	
Ambient temperature (operation)	-25 °C ... 70 °C (for derating, see technical documentation)
Approvals for countries	EU, other countries in preparation
Electromagnetic compatibility	Conformance with EMC Directive 2004/108/EC
Dimensions	72 mm / 90 mm / 62 mm
ATEX	W / H / D Ex II 3 G Ex nA nC IIC T4 Gc X

Ordering data		
Type	Order No.	Pcs. / Pkt.
TC MOBILE I/O X200	2903805	1

Accessories		
Type	Order No.	Pcs. / Pkt.
PSI-GSM/UMTS-QB-ANT	2313371	1
PSI-GSM/UMTS-ANT-OMNI-2-5	2900982	1
PSI-CAB-GSM/UMTS- 5M	2900980	1
PSI-CAB-GSM/UMTS-10M	2900981	1
STEP-PS/ 1AC/24DC/0.75	2868635	1
CABLE-USB/MINI-USB-3,0M	2986135	1
CSMA-LAMBDA/4-2.0-BS-SET	2800491	1

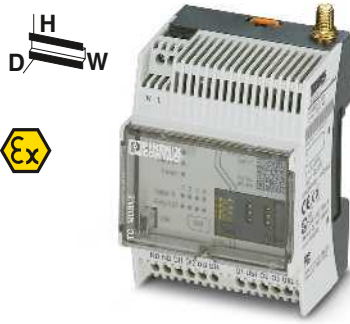

Communication via SMS and e-mail, with wide range power supply

Ex:

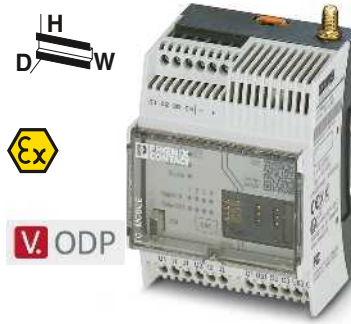

Communication via ODP protocol, 2 additional analog inputs

Ex:

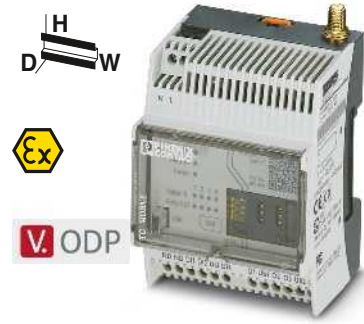

Communication via ODP protocol, with wide range power supply

Ex:

Technical data	
93 V AC ... 250 V AC (47.5 Hz ... 63 Hz)	
30 mA (230 V AC)	
10 mA (stand by)	
USB 2.0	
Mini-USB type B, 5-pos.	
≤ 3 m (only for configuration and diagnostics)	
850 MHz (2 W (EGSM)) / 900 MHz (2 W (EGSM)) / 1800 MHz (1 W (EGSM)) / 1900 MHz (1 W (EGSM))	
4	
-	
-	
-	
-	
4 x N/O contact	
250 V AC	
5 A	
-25 °C ... 70 °C (for derating, see technical documentation)	
EU, other countries in preparation	
Conformance with EMC Directive 2004/108/EC	
72 mm / 90 mm / 62 mm	
II 3 G Ex nA nC IIC T4 Gc X	

Technical data	
10 V DC ... 60 V DC	
110 mA (24 V DC)	
40 mA (stand by)	
USB 2.0	
Mini-USB type B, 5-pos.	
≤ 3 m (only for configuration and diagnostics)	
850 MHz (2 W (EGSM)) / 900 MHz (2 W (EGSM)) / 1800 MHz (1 W (EGSM)) / 1900 MHz (1 W (EGSM))	
4	
2	
0 V DC ... 60 V DC / 0 mA ... 20 mA / 4 mA ... 20 mA (configurable)	
15 Bit	
± 0.1 %	
4 x N/O contact	
60 V	
6 A	
-25 °C ... 70 °C (for derating, see technical documentation)	
EU, other countries in preparation	
Conformance with EMC Directive 2004/108/EC	
72 mm / 90 mm / 62 mm	
II 3 G Ex nA nC IIC T4 Gc X	

Technical data	
93 V AC ... 250 V AC (48 Hz ... 62 Hz)	
30 mA (230 V AC)	
10 mA (stand by)	
USB 2.0	
Mini-USB type B, 5-pos.	
≤ 3 m (only for configuration and diagnostics)	
850 MHz (2 W (EGSM)) / 900 MHz (2 W (EGSM)) / 1800 MHz (1 W (EGSM)) / 1900 MHz (1 W (EGSM))	
4	
-	
-	
-	
-	
4 x N/O contact	
250 V AC	
5 A	
-25 °C ... 70 °C (for derating, see technical documentation)	
EU, other countries in preparation	
Conformance with EMC Directive 2004/108/EC	
72 mm / 90 mm / 62 mm	
II 3 G Ex nA nC IIC T4 Gc X	

Ordering data		
Type	Order No.	Pcs. / Pkt.
TC MOBILE I/O X200 AC	2903806	1

Ordering data		
Type	Order No.	Pcs. / Pkt.
TC MOBILE I/O X300	2903807	1

Ordering data		
Type	Order No.	Pcs. / Pkt.
TC MOBILE I/O X300 AC	2903808	1

Accessories		
Type	Order No.	Pcs. / Pkt.
PSI-GSM/UMTS-QB-ANT	2313371	1
PSI-GSM/UMTS-ANT-OMNI-2-5	2900982	1
PSI-CAB-GSM/UMTS- 5M	2900980	1
PSI-CAB-GSM/UMTS-10M	2900981	1
STEP-PS/ 1AC/24DC/0.75	2868635	1
CABLE-USB/MINI-USB-3,0M	2986135	1
CSMA-LAMBDA/4-2.0-BS-SET	2800491	1

Accessories		
Type	Order No.	Pcs. / Pkt.
PSI-GSM/UMTS-QB-ANT	2313371	1
PSI-GSM/UMTS-ANT-OMNI-2-5	2900982	1
PSI-CAB-GSM/UMTS- 5M	2900980	1
PSI-CAB-GSM/UMTS-10M	2900981	1
STEP-PS/ 1AC/24DC/0.75	2868635	1
CABLE-USB/MINI-USB-3,0M	2986135	1
CSMA-LAMBDA/4-2.0-BS-SET	2800491	1

Accessories		
Type	Order No.	Pcs. / Pkt.
PSI-GSM/UMTS-QB-ANT	2313371	1
PSI-GSM/UMTS-ANT-OMNI-2-5	2900982	1
PSI-CAB-GSM/UMTS- 5M	2900980	1
PSI-CAB-GSM/UMTS-10M	2900981	1
STEP-PS/ 1AC/24DC/0.75	2868635	1
CABLE-USB/MINI-USB-3,0M	2986135	1
CSMA-LAMBDA/4-2.0-BS-SET	2800491	1

Remote communication

Mobile phone network/serial quad band modem for GPRS and GSM

Send RS-232 data all around the world via mobile phone network

Mobile phone network:

- GSM mobile phone networks: 850, 900, 1800, and 1900 MHz
- For worldwide use

GPRS TCP/IP connection:

- Connection established via IP addresses
- Client/server functionality
- IPT compatible
- Integrated TCP/IP stack for TCP and UDP connections
- Data rates of up to 53.6 kbps
- Security:
 - Firewall

GSM dial-up connection:

- Connection established via data phone number (CSD)
- Security:
 - Connection established with password protection
 - Selective call acceptance
 - Callback function

RS-232 interface:

- Freely parameterizable (baud rate, data bits, parity, stop bit, flow control)

Digital I/Os:

- Two digital switching inputs: Sending of freely configurable text messages (SMS, FAX, e-mail)
- One switching output on the backplane

Additional features:

- Encryption of SIM card PINs
- Can be used regardless of controller manufacturer
- High electromagnetic compatibility
- Electrically isolated
- NEW: Convenient configuration software
- Configuration via SMS



Quad-band modem for GPRS and GSM with RS-232 interface, integrated TCP/IP stack and 2 alarm inputs



Supply	
Supply voltage	10 V DC ... 30 V DC (via plug-in COMBICON screw terminal block)
Supply voltage	24 V DC ±5 % (as an alternative or redundant, via backplane bus contact and system current supply)
Nominal current consumption	< 350 mA (24 V DC)
Stand-by current consumption	< 80 mA (stand by)
RS-232 Interface	
Connection method	D-SUB-9 plug
Data format/coding	Serial asynchronous UART/NRZ, 7/8 data, 1/2 stop, 1 parity, 10/11-bit character length
Data flow control/protocols	Software handshake, Xon/Xoff or hardware handshake RTS/CTS
Transmission speed	1,2/2,4/9,6/19,2/38,4/57,6/115,2 kbps (can be set manually and automatically)
Mobile phone network	
Frequencies	850 MHz (2 W (EGSM)) / 900 MHz (2 W (EGSM)) / 1800 MHz (1 W (EGSM)) / 1900 MHz (1 W (EGSM))
SIM interface	1.8 volt, 3 volt
GPRS compatibility	Class 10, Class B
Network function	4 time slots for receiving data, 2 time slot for transmitting data. The PIN is saved in the modem. After a voltage interruption, there is automatic redialing into the network Integrated TCP/IP Stack, independent connection establishment.
Network check	LED to show data signal quality
Antenna connection	50 Ω impedance SMA antenna socket
Digital input	
Number of inputs	2
Signal range	9 V DC ... 60 V DC / 5 mA
Digital output	
Number of outputs	1
Signal range	10 V DC ... 30 V DC ≤ 80 mA (24 V)
General data	
Ambient temperature (operation)	-25 °C ... 60 °C
Electrical isolation	VCC // RS-232 // GSM
Test voltage	1.5 kV (50 Hz, 1 min.)
Approvals for countries	EU, USA, Canada, other countries in preparation
Electromagnetic compatibility	Conformance with R&TTE directive 1999/5/EC
Dimensions	22.5 mm / 99 mm / 118.6 mm

Technical data

Technical data		
10 V DC ... 30 V DC (via plug-in COMBICON screw terminal block)		
24 V DC ±5 % (as an alternative or redundant, via backplane bus contact and system current supply)		
< 350 mA (24 V DC)		
< 80 mA (stand by)		
D-SUB-9 plug		
Serial asynchronous UART/NRZ, 7/8 data, 1/2 stop, 1 parity, 10/11-bit character length		
Software handshake, Xon/Xoff or hardware handshake RTS/CTS		
1,2/2,4/9,6/19,2/38,4/57,6/115,2 kbps (can be set manually and automatically)		
850 MHz (2 W (EGSM)) / 900 MHz (2 W (EGSM)) / 1800 MHz (1 W (EGSM)) / 1900 MHz (1 W (EGSM))		
1.8 volt, 3 volt		
Class 10, Class B		
4 time slots for receiving data, 2 time slot for transmitting data. The PIN is saved in the modem. After a voltage interruption, there is automatic redialing into the network Integrated TCP/IP Stack, independent connection establishment.		
LED to show data signal quality		
50 Ω impedance SMA antenna socket		
2		
9 V DC ... 60 V DC / 5 mA		
1		
10 V DC ... 30 V DC ≤ 80 mA (24 V)		
-25 °C ... 60 °C		
VCC // RS-232 // GSM		
1.5 kV (50 Hz, 1 min.)		
EU, USA, Canada, other countries in preparation		
Conformance with R&TTE directive 1999/5/EC		
22.5 mm / 99 mm / 118.6 mm		

Ordering data

Type	Order No.	Pcs. / Pkt.
PSI-GPRS/GSM-MODEM/RS232-QB	2313106	1

Accessories

PSI-GSM/UMTS-QB-ANT	2313371	1
MINI-SYS-PS-100-240AC/24DC/1.5	2866983	1
ME 22,5 TBUS 1,5/ 5-ST-3,81 GN	2707437	50
PSM-KA9SUB9/BB/2METER	2799474	1
PSM-KA9SUB9/BB/0,5METER	2708520	1

Description	W / H / D
Industrial GPRS/GSM modem with RS-232 interface , scope of supply: Modem, CD with configuration software and user manual	
Multi-band antenna for UMTS and quad band GSM, with omnidirectional characteristic, 2 m antenna cable with SMA round connector, degree of protection: IP65, dimensions: 76 x 20 mm	
System power supply unit , primary-switched	
DIN rail connector	
RS-232-D-SUB cable , length: 2 m	
RS-232-D-SUB cable , length: 0.5 m	

Mobile phone network/mobile phone routers with firewall and VPN

Mobile phone routers support high-performance remote connections to remote Ethernet networks. These connections can be used to transmit sensitive data securely over mobile phone networks.

The integrated firewall and VPN (Virtual Private Network) support and reliably protect the application against unauthorized access. The Ethernet connection can be used for system-wide communication between all connected components in the network, such as drives, controllers, control panels or visualization PCs.

Mobile TCP/IP connection:

- Connection established via IP addresses
- GPRS/EDGE data rates of up to 210 kbps
- UMTS/HSPA data rates of up to 7.2 Mbps
- Security:
 - Firewall
 - NAT table

VPN (virtual private network):

- IPsec and OpenVPN support
- Up to three VPN tunnels simultaneously
- Authentication with X.509 certificates and via pre-shared key (PSK)
- VPN remote start via call or SMS
- 1:1 NAT in the VPN

Digital I/Os:

- 6 digital switching inputs: Sending of freely configurable text messages (SMS, FAX, e-mail) and starting of user-defined functions
- Four switching outputs: Can be activated via SMS and Ethernet and for GSM and connection diagnostics

Additional features:

- Configuration via web-based management
- Upload and download configuration
- Configurable daily restart
- Continuous connection monitoring
- High electromagnetic compatibility
- Electrically isolated

Supply	
Supply voltage	
Nominal current consumption	
Stand-by current consumption	
Ethernet interface	
Connection method	
Transmission speed	
Transmission length	
Functions	
Management	
Mobile phone network	
Frequencies	
SIM interface	
GPRS compatibility	
Network check	
Antenna connection	
Digital input	
Number of inputs	
Signal range	
Digital output	
Number of outputs	
Signal range	
General data	
Ambient temperature (operation)	
Electrical isolation	
Test voltage	
Approvals for countries	
Electromagnetic compatibility	
Dimensions	W / H / D

Description	
Industrial mobile phone router , with integrated firewall and VPN, 6 digital inputs and 4 outputs, and continuous connection monitoring	
- For UMTS/HSPA with GPRS/EDGE fallback and dual SIM for backup provider	
- For GPRS/EDGE quad band, 35 mm housing width	

Multi-band antenna for UMTS and quad band GSM, with omnidirectional characteristic, 2 m antenna cable with SMA round connector, degree of protection: IP65, dimensions: 76 x 20 mm	
---	--

Multiband antenna for external panel and external mast mounting for UMTS and quad-band GSM, with omnidirectional characteristics, 5 m antenna cable with SMA round connector	
---	--

Antenna extension cable for UMTS and quad-band GSM, with SMA connector and SMA coupling	
--	--

Antenna extension cable for UMTS and quad-band GSM, 10 m long, antenna cable with SMA connector and SMA coupling	
---	--



GPRS/EDGE and UMTS/HSPA mobile phone routers for worldwide network access



Technical data	
Supply	10 V DC ... 30 V DC (via plug-in COMBICON screw terminal block)
Nominal current consumption	< 200 mA (24 V DC)
Stand-by current consumption	< 90 mA (stand by)
Ethernet interface	RJ45 socket, shielded
Connection method	10/100 Mbps, auto negotiation
Transmission speed	100 m (shielded twisted pair)
Transmission length	
Functions	Web-based management, SNMP
Management	
Mobile phone network	850 MHz (2 W (EGSM)) / 900 MHz (2 W (EGSM)) / 1800 MHz (1 W (EGSM)) / 1900 MHz (1 W (EGSM)) / 850 MHz (0.25 W (UMTS)) / 1900 MHz (0.25 W (UMTS)) / 2100 MHz (0.25 W (UMTS))
Frequencies	1.8 volt, 3 volt
SIM interface	Class 12, Class B
GPRS compatibility	LED bar graph to display receive quality
Network check	50 Ω impedance SMA antenna socket
Antenna connection	
Digital input	6
Number of inputs	10 V DC ... 30 V DC
Signal range	
Digital output	4
Number of outputs	10 V DC ... 30 V DC (Depending on the operating voltage)
Signal range	≤ 50 mA (short-circuit-proof)
General data	
Ambient temperature (operation)	-25 °C ... 65 °C (not aligned)
Electrical isolation	VCC // UMTS // Ethernet // PE
Test voltage	1 kV (50 Hz, 1 min.)
Approvals for countries	EU, USA, Canada, other countries in preparation
Electromagnetic compatibility	Conformance with R&TTE directive 1999/5/EC
Dimensions	45 mm / 99 mm / 114.5 mm

Ordering data		
Type	Order No.	Pcs. / Pkt.
PSI-MODEM-3G/ROUTER	2314008	1
PSI-MODEM-GSM/ETH	2313355	1

Accessories		
Type	Order No.	Pcs. / Pkt.
PSI-GSM/UMTS-QB-ANT	2313371	1
PSI-GSM/UMTS-ANT-OMNI-2-5	2900982	1
PSI-CAB-GSM/UMTS- 5M	2900980	1
PSI-CAB-GSM/UMTS-10M	2900981	1

Mobile phone network/ MGUARD security routers



Industrial mobile phone routers featuring mGuard technology for global communication via UMTS and CDMA networks.

Thanks to the integrated high-speed mobile phone interface and 4-port switch in compact metal housing, the new **TC MGUARD RS2/4000 VPN** security appliances create a system for global, secure industrial remote communication.

They have an SD card slot at the front for configuration memory. The SD cards can be used for starting up or replacing the devices quickly and easily. The devices feature an extended temperature range and have a buffered realtime clock and trusted platform module (TPM) for secure key generation and management. They support precise time synchronization and positioning, specifically for mobile applications, via GPS and GLONASS.

The **TC MGUARD RS4000 3G** devices provide high-availability high-end security for industry and a remote maintenance infrastructure for the secure connection of machines and systems. For maximum availability, an additional external network is supported redundantly alongside the internal network (LAN) and the external network (WAN) in the form of the mobile phone interface. The integrated 4-port switch offers management features and supports EtherNet/IP™.

The **TC MGUARD RS2000 3G** devices are designed for applications with fewer complex requirements and allow secure remote maintenance of machines and systems in the field via the Internet. In this context, they are used as industrial remote service routers with a simplified configuration. The integrated 4-port switch saves valuable space on the DIN rail.

Both versions have all the necessary standard functions for operating an Ethernet network that is both flexible and robust.

Features:

- Port mirroring
- Configuration can be stored externally
- Web-based management, SNMP
- Replaceable configuration memory
- Comprehensive connection options
- Flexible routing
- Intelligent stateful inspection firewall
- Secure remote services (VPN)
According to IPsec standard

Serial device server included

The integrated COMSERVER function is used to integrate serial RS-232 interfaces into Ethernet networks. This provides an easy way of implementing functions such as cable replacement or network integration.

- Cable replacement: two devices in combination tunnel serial connections via Ethernet
- Network integration: you can integrate automation devices such as controllers or frequency inverters into a network using corresponding programming and diagnostics software

Device Manager

The Device Manager simplifies the management of MGUARD security appliances. The tool features a template mechanism that enables the user to configure and manage all MGUARD devices centrally – from a few hundred devices to several thousand.

**Mobile phone network/
MGUARD security routers**

Notes:

Central device management software, the Device Manager for FL MGUARD devices can be found on page 323.

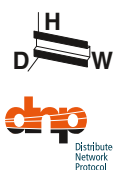

UMTS/HSPA mobile phone router with firewall and VPN, manageable 4-port switch, DMZ port and second WAN interface

UMTS/HSPA mobile phone router with firewall and VPN, integrated 4-port switch



Supply	
Supply voltage	11 V DC ... 36 V DC (via plug-in COMBICON screw terminal block)
Nominal current consumption	< 200 mA (24 V DC)
Ethernet interface	
Connection method	RJ45
Transmission speed	10/100 Mbps (auto negotiation)
Transmission length	100 m (shielded twisted pair)
Functions	
Management	Web-based management, SNMP
Basic functions	Router with intelligent firewall and VPN for 10 tunnels (up to 250 supported with optional additional license), CIFS Integrity Monitoring (as an option), metal housing, slot for SD memory card
Security functions	
Number of VPN tunnels	10 (up to 250 tunnels with additional license as an option)
Encryption methods	DES, 3DES, AES-128, -192, -256
Internet Protocol Security (IPsec) mode	ESP tunnel / ESP transport
Authentication	X.509v3 certificates with RSA or PSK
Firewall rules	Configurable stateful inspection firewall with full scope of functions
Routing	
Mobile phone network	Standard routing, NAT, 1:1-NAT, port forwarding
Frequencies	
	850 MHz (2 W (EGSM)) / 900 MHz (2 W (EGSM)) / 1800 MHz (1 W (EGSM)) / 1900 MHz (1 W (EGSM)) / 800 MHz (0.25 W (UMTS)) / 850 MHz (0.25 W (UMTS)) / 900 MHz (0.25 W (UMTS)) / 1900 MHz (0.25 W (UMTS)) / 2100 MHz (0.25 W (UMTS)) / 800 MHz (CDMA2000 EV-DO) / 1900 MHz (CDMA2000 EV-DO)
SIM interface	
GPRS compatibility	1.8 volt, 3 volt
Network check	Class 12, Class B
Antenna connection	LED bar graph to display receive quality
Digital input	50 Ω impedance SMA antenna socket
Digital input	
Number of inputs	3
Signal range	10 V DC ... 30 V DC / 5 mA
Digital output	
Number of outputs	3
Signal range	10 V DC ... 30 V DC (Depending on the operating voltage) ≤ 250 mA (short-circuit-proof)
General data	
Ambient temperature (operation)	-40 °C ... 60 °C
Electrical isolation	VCC // PE
Test voltage	1 kV (50 Hz, 1 min.)
Dimensions	45 mm / 130 mm / 114 mm

Technical data		
11 V DC ... 36 V DC (via plug-in COMBICON screw terminal block)		
< 200 mA (24 V DC)		
RJ45		
10/100 Mbps (auto negotiation)		
100 m (shielded twisted pair)		
Web-based management, SNMP		
Router with intelligent firewall and VPN for 10 tunnels (up to 250 supported with optional additional license), CIFS Integrity Monitoring (as an option), metal housing, slot for SD memory card		
10 (up to 250 tunnels with additional license as an option)		
DES, 3DES, AES-128, -192, -256		
ESP tunnel / ESP transport		
X.509v3 certificates with RSA or PSK		
Configurable stateful inspection firewall with full scope of functions		
Standard routing, NAT, 1:1-NAT, port forwarding		
850 MHz (2 W (EGSM)) / 900 MHz (2 W (EGSM)) / 1800 MHz (1 W (EGSM)) / 1900 MHz (1 W (EGSM)) / 800 MHz (0.25 W (UMTS)) / 850 MHz (0.25 W (UMTS)) / 900 MHz (0.25 W (UMTS)) / 1900 MHz (0.25 W (UMTS)) / 2100 MHz (0.25 W (UMTS)) / 800 MHz (CDMA2000 EV-DO) / 1900 MHz (CDMA2000 EV-DO)		
1.8 volt, 3 volt		
Class 12, Class B		
LED bar graph to display receive quality		
50 Ω impedance SMA antenna socket		
3		
10 V DC ... 30 V DC / 5 mA		
3		
10 V DC ... 30 V DC (Depending on the operating voltage) ≤ 250 mA (short-circuit-proof)		
-40 °C ... 60 °C		
VCC // PE		
1 kV (50 Hz, 1 min.)		
45 mm / 130 mm / 114 mm		

Technical data		
11 V DC ... 36 V DC (via plug-in COMBICON screw terminal block)		
< 200 mA (24 V DC)		
RJ45		
10/100 Mbps (auto negotiation)		
100 m (shielded twisted pair)		
Web-based management, SNMP		
Router with simplified 2-click firewall and VPN for 2 tunnels (fixed), metal housing, slot for any SD memory card		
2 (fixed, Ipsec (IETF standard))		
DES, 3DES, AES-128, -192, -256		
ESP tunnel / ESP transport		
X.509v3 certificates with RSA or PSK		
Simplified 2-click stateful inspection firewall		
Standard routing, NAT, 1:1-NAT, port forwarding		
850 MHz (2 W (EGSM)) / 900 MHz (2 W (EGSM)) / 1800 MHz (1 W (EGSM)) / 1900 MHz (1 W (EGSM)) / 800 MHz (0.25 W (UMTS)) / 850 MHz (0.25 W (UMTS)) / 900 MHz (0.25 W (UMTS)) / 1900 MHz (0.25 W (UMTS)) / 2100 MHz (0.25 W (UMTS)) / 800 MHz (CDMA2000 EV-DO) / 1900 MHz (CDMA2000 EV-DO)		
1.8 volt, 3 volt		
Class 12, Class B		
LED bar graph to display receive quality		
50 Ω impedance SMA antenna socket		
3		
10 V DC ... 30 V DC / 5 mA		
3		
10 V DC ... 30 V DC (Depending on the operating voltage) ≤ 250 mA (short-circuit-proof)		
-40 °C ... 60 °C		
VCC // PE		
1 kV (50 Hz, 1 min.)		
45 mm / 130 mm / 114 mm		

Description	
Mobile phone router with mGuard technology, VPN and firewall, replaceable memory, GPS time synchronization, serial device server for RS-232	
- 2 x WAN interface (1 x RJ45, 1 x mobile phone technology), 4 x LAN interface (RJ45, manageable), DMZ port	
- 1 x WAN interface (mobile phone technology), 4 x LAN interface (RJ45)	

Ordering data			
Type	Order No.	Pcs. / Pkt.	
TC MGUARD RS4000 3G VPN	2903440	1	

Ordering data			
Type	Order No.	Pcs. / Pkt.	
TC MGUARD RS2000 3G VPN	2903441	1	

Parameterization memory	
License to configure and operate 250 VPN tunnels on FL MGUARD	
License to configure any number of tunnels and operate 250 VPN tunnels on FL MGUARD	

Accessories			
SD FLASH 256MB	2988120	1	
FL MGUARD LIC VPN-250	2700193	1	
FL MGUARD LIC VPN-250 GROUP	2700192	1	

Accessories			
SD FLASH 256MB	2988120	1	

Remote communication

Public network/ DSL broadband routers



Industrial ADSL broadband router - supports ADSL/ADSL2/ADSL2+ according to Annex A and B

The **TC DSL ROUTER** range supports the high-speed connection of industrial Ethernet or RS-232 devices to the Internet using high-availability ADSL technology. Machines, systems or complete Ethernet networks can therefore be accessed from anywhere in the world at any time using a broadband Internet connection.

Developed specifically for use in industrial environments, the TC DSL ROUTERS are suitable both for short-term high-speed access in the case of servicing and for the permanent connection of remote stations to a central company network when used in combination with the integrated security functions.

Remote maintenance (short-term high-speed access)

- Quick and easy remote access to machines, systems or Ethernet networks

Remote control (VPN tunnel)

- Permanent connection of substations to the control room for cyclic data acquisition and monitoring
- Highly secure broadband alternative to analog permanent line applications

Alarm generation and remote control

- High-availability alarm generation via e-mail
- Individual configuration of switching outputs, such as worldwide remote control of switching outputs or indication of a DSL connection abort, etc.

Features:

The DSL broadband routers are designed for worldwide and flexible use, there is no need for the application/provider requirements to be clarified in advance. This enables individual and fast startup on site.

One universal device type

- All common ADSL standards are supported (ADSL/ADSL2/ADSL2+)
- Integrated Annex A/B switchover

Note: the specifications for the standard and frequency range used (Annex) depend on the provider and are included in the access data sent by the provider.

- Annex A: DSL operation parallel to analog telephony (in most of the world)
- Annex B: DSL operation parallel to ISDN (in Germany and neighboring countries)

Individual function selection between modem or router function

- DSL modem: converter from DSL to LAN - the router/firewall function is performed by a separate router, e.g., FL MGuard
- DSL router: DSL modem plus integrated router functions, e.g., firewall, VPN, NAT, etc.

All TC DSL routers offer increased resistance to typical industrial influences, such as temperature and EMI, and therefore increased fault tolerance and application availability.

TC DSL ROUTER X400 A/B

- Quick and easy startup
- Optimized to the key functions of an industrial DSL broadband router/modem
- Integrated firewall

TC DSL ROUTER X500 A/B

- Multifunctional for highly secure network access
- Suitable for special applications
- DSL broadband router/modem
- VPN tunneling:
 - IPsec (client and server)
 - Open VPN (client)
- NAT table
- Serial device server for 10/100Base-T(X) with RS-232
- Alarm inputs: send e-mails
- Switching outputs: set by WBM local/remote, VPN service, connection lost, DSL/Internet link



Ethernet

DSL

DSL router/modem with firewall



Ethernet

DSL

DSL router/modem with firewall, VPN, serial device server, inputs/outputs

	Technical data	Technical data
Supply		
Supply voltage	10 V DC ... 30 V DC (via plug-in COMBICON screw terminal block)	10 V DC ... 30 V DC (via plug-in COMBICON screw terminal block)
Nominal current consumption	< 150 mA (24 V DC)	< 150 mA (24 V DC)
Stand-by current consumption	< 135 mA (stand by)	< 135 mA (stand by)
RS-232 Interface		
Connection method	-	D-SUB-9 plug
Transmission speed	-	0.3; 1.2; 2.4; 4.8; 9.6; 19.2; 38.4; 57.6; 115.2 kbps
Transmission length	-	15 m
Ethernet interface		
Connection method	8P8C RJ45 socket, shielded	8P8C RJ45 socket, shielded
Transmission speed	10/100 Mbps, auto negotiation	10/100 Mbps, auto negotiation
Transmission length	≤ 100 m (shielded twisted pair)	≤ 100 m (shielded twisted pair)
Supported protocols	TCP/IP, UDP/IP, FTP, HTTP	TCP/IP, UDP/IP, FTP, HTTP
Auxiliary protocols	ARP, DHCP, PING (ICMP), SNMP V1, SMTP	ARP, DHCP, PING (ICMP), SNMP V1, SMTP
DSL interface		
Connection method	6P2C RJ11 socket, shielded COMBICON plug-in screw terminal block	6P2C RJ11 socket, shielded COMBICON plug-in screw terminal block
Transmission speed	≤ 25 Mbps (downstream from Internet) ≤ 1 Mbps (upstream to Internet)	≤ 25 Mbps (downstream from Internet) ≤ 1 Mbps (upstream to Internet)
Transmission length	≤ 5 km	≤ 5 km
Functions		
Management	Web-based management	Web-based management
Security functions		
Number of VPN tunnels	-	3
Firewall rules	Stateful inspection firewall	Stateful inspection firewall
Digital input		
Number of inputs	-	6
Signal range	-	10 V DC ... 30 V DC / 5 mA
Digital output		
Number of outputs	-	4
Signal range	-	10 V DC ... 30 V DC (Depending on the operating voltage) ≤ 50 mA (short-circuit-proof)
General data		
Ambient temperature (operation)	-20 °C ... 60 °C	-20 °C ... 60 °C
Degree of protection	IP20	IP20
Electrical isolation	VCC//ADSL//Ethernet//FE	VCC + IO + RS-232//ADSL//Ethernet//FE
Test voltage	1.5 kV _{rms} (50 Hz, 1 min.)	1.5 kV _{rms} (50 Hz, 1 min.)
Approvals for countries	EU, other countries in preparation	EU, other countries in preparation
Electromagnetic compatibility	Conformance with R&TTE directive 1999/5/EC	Conformance with R&TTE directive 1999/5/EC
Dimensions	W / H / D 45 mm / 99 mm / 112 mm	45 mm / 99 mm / 112 mm

	Ordering data			Ordering data		
Description	Type	Order No.	Pcs. / Pkt.	Type	Order No.	Pcs. / Pkt.
Industrial ADSL broadband router , according to Annex A and B						
	TC DSL ROUTER X400 A/B	2902709	1	TC DSL ROUTER X500 A/B	2902710	1
	Accessories			Accessories		
System power supply unit , primary-switched	MINI-SYS-PS-100-240AC/24DC/1.5	2866983	1	MINI-SYS-PS-100-240AC/24DC/1.5	2866983	1
DATATRAB , protective adapter for insertion in the data cable	DT-TELE-RJ45	2882925	1	DT-TELE-RJ45	2882925	1
DATATRAB adapter , protective adapter for inserting into the data cable	DT-LAN-CAT.6+	2881007	1	DT-LAN-CAT.6+	2881007	1

Public network/ analog modems



The analog modems are specifically designed to meet industrial requirements for worldwide remote maintenance. Serial connections on the public, analog phone network with speeds of up to 33.6 kbps are supported, as is dial-up to the GSM mobile communication network.

Remote maintenance via dial-up connection:

- Direct access to remotely located controllers for software updates and remote diagnostics

PSI-MODEM/ETH

Dial-up line modem for accessing a remote Ethernet network

- Permanent 128-bit authentication
- CHAP protocol

PSI-DATA/BASIC-MODEM/RS232

Dial-up line modem for remote maintenance of systems with a RS-232 interface

PSI-MODEM-BASIC/USB

Dial-up line modem for remote maintenance of systems with USB interface

- 5 V DC supply via USB interface

All devices feature:

- For interference-proof operation, including under harsh EMC conditions:
 - High-quality electrical isolation
 - Integrated surge protection
- Comprehensive security functions that prevent unauthorized access by means of
 - Configurable, selective call acceptance
 - Connection establishment with password protection
 - Callback function

Supply	
Supply voltage	
Supply voltage	
Nominal current consumption	
Stand-by current consumption	
Serial port	
Interfaces	
Connection method	
Data format/coding	
Data flow control/protocols	
Transmission speed	
PSTN port (a/b line)	
Connection method	
Dialing procedure	
General data	
Ambient temperature (operation)	
Electrical isolation	
Test voltage	
Approvals for countries	
Electromagnetic compatibility	
Dimensions	W / H / D

Description	
Industrial, analog Ethernet modem, Scope of supply: Modem, RJ12/RJ12 cable, TAE adapter	
Industrial analog modem, alarm input and output, scope of delivery: Modem, CD with configuration software, manual and RJ12/RJ12 cable	
Industrial analog modem with USB connection, scope of supply: Modem, driver CD with manual, USB cable and RJ12/RJ12 cable	

System power supply, primary-switched	
DIN rail connector	
RS-232-D-SUB cable, length: 2 m	
RS-232-D-SUB cable, length: 0.5 m	



Modem for dial-up operation with Ethernet connection (LAN)



Modem for dial-up operation with RS-232 connection

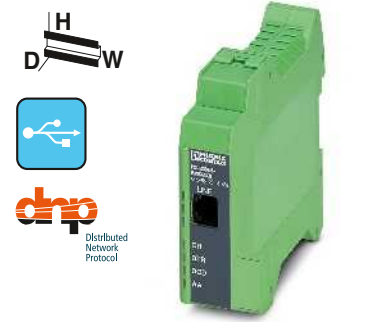

Modem for dial-up operation with USB connection



Technical data
10 V DC ... 30 V DC (via plug-in COMBICON screw terminal block)
24 V DC $\pm 5\%$ (as an alternative or redundant, via backplane bus contact and system current supply)
< 100 mA (24 V DC) < 70 mA
Ethernet interface, 10/100BASE-T(X) according to IEEE 802.3u
RJ45 socket, shielded
TCP/IP, UDP, TFTP, HTTP, Modbus/TCP, PPP, PROFINET, EtherNet IP, CHAP 10/100 Mbps, auto negotiation
RJ12, 6-pos. Multiple frequency/pulse dialing, configuration via software
0 °C ... 55 °C VCC // PSTN // Ethernet 1.5 kV (50 Hz, 1 min.) EU, USA, Canada, other countries in preparation
Conformance with EMC Directive 2004/108/EC 45 mm / 99 mm / 114.5 mm

Technical data
10 V DC ... 30 V DC (via plug-in COMBICON screw terminal block)
24 V DC $\pm 5\%$ (as an alternative or redundant, via backplane bus contact and system current supply)
< 100 mA (24 V DC) < 40 mA
RS-232 interface according to ITU-T V.28, EIA/TIA-232, DIN 66259-1 D-SUB-9 plug Serial asynchronous UART/NRZ, 7/8 data, 1/2 stop, 1 parity, 10/11-bit character length Software handshake, Xon/Xoff or hardware handshake RTS/CTS
Automatic data rate detection 300, 1200, 2400, 4800, 9600, 19200, 38400, 57600, 115200 bits/s
RJ12, 6-pos. Multiple frequency/pulse dialing, configuration via software
0 °C ... 55 °C VCC // PSTN // RS-232 1.5 kV EU, USA, Canada, other countries in preparation
Conformance with EMC Directive 2004/108/EC 22.5 mm / 99 mm / 114.5 mm

Technical data
-
5 V DC (via mini USB type B)
< 100 mA (for 5 V DC, nominal operation) < 40 mA (for 5 V DC, sleep mode)
USB 1.1
Mini USB type B
-
-
RJ12, 6-pos. Multiple frequency/pulse dialing, configuration via software
0 °C ... 55 °C PSTN // USB 1.5 kV EU, USA, Canada, other countries in preparation
Conformance with EMC Directive 2004/108/EC 22.5 mm / 99 mm / 114.5 mm

Ordering data		
Type	Order No.	Pcs. / Pkt.
PSI-MODEM/ETH	2313300	1

Ordering data		
Type	Order No.	Pcs. / Pkt.
PSI-DATA/BASIC-MODEM/RS232	2313067	1

Ordering data		
Type	Order No.	Pcs. / Pkt.
PSI-MODEM-BASIC/USB	2313436	1

Accessories		
MINI-SYS-PS-100-240AC/24DC/1.5	2866983	1
ME 22,5 TBUS 1,5/ 5-ST-3,81 GN	2707437	50

Accessories		
MINI-SYS-PS-100-240AC/24DC/1.5	2866983	1
ME 22,5 TBUS 1,5/ 5-ST-3,81 GN	2707437	50
PSM-KA9SUB9/BB/2METER	2799474	1
PSM-KA9SUB9/BB/0,5METER	2708520	1

Accessories		



Network Ethernet, PROFIBUS or serial devices that are up to 20 km away from each other via existing copper cables, e.g., using in-house telephone lines. No special Ethernet or fiberglass cables are required.

Ethernet:

- Plug and play
- Distances up to 20 km
- Data rates of up to 30 Mbps (4-wire)
- Data rates of up to 15.3 Mbps (2-wire)
- Robust modulation method (SHDSL)
- Via in-house cables, not via the public telephone network

Ethernet interface:

- Plug and play
- No IP configuration required
- Protocol transparent (IPv4 and IPv6)
- RSTP (Rapid Spanning Tree Protocol) support
- PROFINET (strict priority)

Topologies:

- Point-to-point
- Line structure
- Ring structure
- Redundancy operation

Additional features:

- Two digital outputs for status transmission
- Configuration software for extended functionality
- Online diagnostics
- Logbook function
- Saving and printing of project and device configurations

PROFIBUS:

- Distances up to 20 km
- Data rates of up to 1.5 Mbps (point-to-point)
- Data rates of up to 500 kbps (line structure - up to 30 devices)
- Via in-house cables, not via the public telephone network
- Robust modulation method (SHDSL)
- Redundancy operation supported
- Configuration software
- Easy, guided configuration
- Calculation of the maximum PROFIBUS data rate
- Calculation of the slot time
- Online diagnostics
- Mixed operation of copper cables and fiber optics

RS-232/RS-422/RS-485:

- RS-232 interface (9-pos. D-SUB):
 - Data rates of up to 230.4 kbps
 - Automatic DCE/DTE switchover
- RS-422/RS-485 W2 interface (COMBICON plug):
 - Data rates of up to 2000 kbps
 - Termination resistor; can be enabled/disabled (RS-485 W2)

Additional information can be found in the relevant data sheets/user manuals.

Supply	
Supply voltage	
Supply voltage	
Nominal current consumption	
RS-232 interface	
Connection method	
Transmission speed	
RS-422 interface	
Connection method	
Transmission speed	
RS-485 interface	
Connection method	
Transmission speed	
Ethernet interface	
Connection method	
Transmission speed	
SHDSL interface	
Connection method	
Transmission speed	
USB interface	
Connection method	
Transmission length	
Functions	
Management	
Digital output	
Number of outputs	
Signal range	
Behavior of outputs	
General data	
Ambient temperature (operation)	
Electrical isolation	
Test voltage	
Electromagnetic compatibility	
Dimensions	W / H / D

Description

SHDSL permanent line modem, for point-to-point, linear, and star structures on in-house 2- and 4-wire cables

System power supply, primary-switched

DIN rail connector (optional), for routing through the supply voltage and data signal, two pieces are required per device

DATATRAB adapter, protective adapter with RJ45 and screw connection for two SHDSL telecommunications interfaces

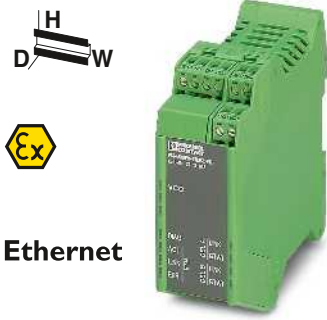

Ethernet

Ethernet extender



RS-232

Serial extender

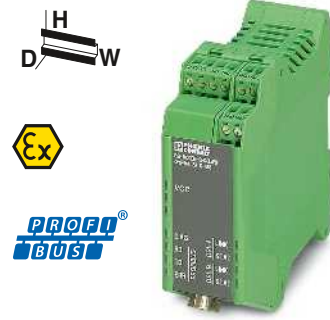

PROFIBUS extender



Technical data
18 V DC ... 30 V DC 24 V DC ±5 % (as an alternative or redundant, via backplane bus contact and system current supply)
< 180 mA (24 V DC)
-
-
-
-
-
RJ45 socket, shielded 10/100 Mbps, auto negotiation SHDSL interface according to ITU-T G.991.2.bis 2 x 2-pos. COMBICON plug-in screw terminal blocks 4-wire operation: 64 kbps ... 30 Mbps 2-wire operation: 32 kbps ... 15.3 Mbps USB 2.0 Mini-USB type B, 5-pos. < 5 m (only for configuration and diagnostics)
Plug and play, user-friendly software: Diagnostic functions, log book, individual configuration
2 Depending on the operating voltage ≤ 150 mA (short-circuit-proof) Deactivated for device supply via T-BUS
-20 °C ... 60 °C (freestanding (40 mm spacing to the right and left), no supply of other modules via the device)
DIN EN 50178 (VCC // Ethernet // DSL (A) // DSL (B) // FE)
1.5 kV _{rms} (50 Hz, 1 min.) Conformance with EMC Directive 2004/108/EC 35 mm / 99 mm / 114.5 mm

Technical data
18 V DC ... 30 V DC 24 V DC ±5 % (as an alternative or redundant, via backplane bus contact and system current supply)
< 180 mA (24 V DC)
-
D-SUB-9 plug 0.11/0.3/1.2/2.4/4.8/9.6/19.2/38.4/57.6/115.2/230.4 kbps, NRZ
RS-422 interface according to ITU-T V.11, EIA/TIA-422, DIN 66348-1 Plug-in/screw connection via COMBICON 1.2/2.4/4.8/7.0/9.6/19.2/38.4/57.6/75/93.75/115.2/136/187.5/375/500/1500/2000 kbps, NRZ RS-485 interface, according to EIA/TIA-485, DIN 66259-4/RS-485 2-wire Plug-in/screw connection via COMBICON 1.2/2.4/4.8/7.0/9.6/19.2/38.4/57.6/75/93.75/115.2/136/187.5/375/500/1500/2000 kbps, NRZ
-
-
SHDSL interface according to ITU-T G.991.2.bis 2 x 2-pos. COMBICON plug-in screw terminal blocks 4-wire operation: 64 kbps ... 30 Mbps 2-wire operation: 32 kbps ... 15.3 Mbps USB 2.0 Mini-USB type B, 5-pos. < 5 m (only for configuration and diagnostics)
User-friendly software: Guided configuration, plausibility checks, diagnostic functions, log book
2 Depending on the operating voltage ≤ 150 mA (short-circuit-proof) Deactivated for device supply via T-BUS
-20 °C ... 60 °C (for derating, see technical documentation)
DIN EN 50178 (VCC, RS-232 // RS-422, RS-485 // DSL (A) // DSL (B) // FE)
1.5 kV _{rms} (50 Hz, 1 min.) Conformance with EMC Directive 2004/108/EC 35 mm / 99 mm / 114.5 mm

Technical data
18 V DC ... 30 V DC 24 V DC ±5 % (as an alternative or redundant, via backplane bus contact and system current supply)
< 180 mA (24 V DC)
-
-
-
-
PROFIBUS according to IEC 61158, RS-485 2-wire, half duplex, automatic control D-SUB-9 socket 9.6/19.2/45.45/93.75/187.5/500/1500 kbps, set via configuration software
-
-
SHDSL interface according to ITU-T G.991.2.bis 2 x 2-pos. COMBICON plug-in screw terminal blocks 4-wire operation: 64 kbps ... 30 Mbps 2-wire operation: 32 kbps ... 15.3 Mbps USB 2.0 Mini-USB type B, 5-pos. < 5 m (only for configuration and diagnostics)
User-friendly software: Guided configuration, plausibility checks, diagnostic functions, log book
2 Depending on the operating voltage ≤ 150 mA (short-circuit-proof) Deactivated for device supply via T-BUS
-20 °C ... 60 °C (for derating, see technical documentation)
DIN EN 50178 (VCC // PROFIBUS // DSL (A) // DSL (B) // FE)
1.5 kV _{rms} (50 Hz, 1 min.) Conformance with EMC Directive 2004/108/EC 35 mm / 99 mm / 114.5 mm

Ordering data		
Type	Order No.	Pcs. / Pkt.
PSI-MODEM-SHDSL/ETH	2313643	1

Ordering data		
Type	Order No.	Pcs. / Pkt.
PSI-MODEM-SHDSL/SERIAL	2313669	1

Ordering data		
Type	Order No.	Pcs. / Pkt.
PSI-MODEM-SHDSL/PB	2313656	1

Accessories		
MINI-SYS-PS-100-240AC/24DC/1.5	2866983	1
ME 17,5 TBUS 1,5/ 5-ST-3,81 GN	2709561	10
DT-TELE-SHDSL	2801593	1

Accessories		
MINI-SYS-PS-100-240AC/24DC/1.5	2866983	1
ME 17,5 TBUS 1,5/ 5-ST-3,81 GN	2709561	10
DT-TELE-SHDSL	2801593	1

Accessories		
MINI-SYS-PS-100-240AC/24DC/1.5	2866983	1
ME 17,5 TBUS 1,5/ 5-ST-3,81 GN	2709561	10
DT-TELE-SHDSL	2801593	1

Protocol converter

The **RESYGATE 1000/3000** protocol converter enables the process connection of remote control stations with different protocols to an IEC 60870-5-101 or IEC 60870-5-104-based control system.

The IEC 60870-5-104, IEC 60870-5-101, Modbus/RTU, and Modbus/TCP protocols are supported for the connection of remote control stations.

The individual protocols are parameterized and set via user-friendly interfaces in the configuration tool.

Features:

- Connection of existing IEC 60870-5-101 and/or Modbus remote control stations when upgrading the control system to the IEC 60870-5-104 protocol
- High availability of the overall system thanks to redundant connection
- Conversion of the IEC 60870-5-104, IEC 60870-5-101, Modbus/RTU, and Modbus/TCP protocols to the IEC 60870-5-104 or IEC 60870-5-101 protocol
- Up to 18 serial terminal devices can be used depending on the protocols used

new



Computer data	
Processor	
RAM (configuration option)	
Mass storage (configuration option)	
Interfaces	
Slots	
Monitor output	
Network	
Power supply unit	
Supported remote control protocols	
General data	
Dimensions	W / H / D
Degree of protection	
Ambient temperature (operation)	
Permissible humidity (operation)	
Mounting type	
Vibration (operation)	
Shock	

Technical data		
	RESYGATE 1000	RESYGATE 3000
Processor	Intel® Atom™ N455 1.66 GHz	Intel® Celeron® N2930 1.83 GHz/2.16 GHz
RAM	2 GB DDR3 SODIMM	
Mass storage	CompactFlash®, 4 GB	4 GB CFast® card
Interfaces	1x COM (RS-232/422/485)	1x COM (RS-232/422/485)
	2x COM (RS-232)	2x COM (RS-232)
	4x USB 2.0	3x USB 2.0 1x USB 3.0
Slots	without slots	
Monitor output	VGA	2x DisplayPort
Network	2x Ethernet (10/100/1000 Mbps), RJ45	
Power supply unit	24 V DC ±20%	
Supported remote control protocols	IEC 60870-5-101 Balanced Mode IEC 60870-5-101 Unbalanced Mode IEC 60870-5-104 Client IEC 60870-5-104 Server, max. 4 Client Modbus RTU Master Modbus TCP Master	
Dimensions	155 mm / 145 mm / 49 mm	162 mm / 146.2 mm / 49 mm
Degree of protection	IP20	
Ambient temperature (operation)	0 °C ... 50 °C	-20 °C ... 50 °C
Permissible humidity (operation)	5 % ... 95 % (non-condensing)	
Mounting type	DIN rail mounting	
Vibration (operation)	DIN EN 60068-2-6	
Shock	15g, 11 ms according to IEC 60068-2-27	

Description	
Protocol converter	
	- for a maximum of 500 data points
	- for a maximum of 4000 data points

Ordering data		
Type	Order No.	Pcs. / Pkt.
RESYGATE 1000	2400128	1
RESYGATE 3000	2400129	1

Antennas

The antennas can be used as multiband antennas for all GSM and UMTS networks.

The PSI-GSM/UMTS-ANT-OMNI-2-5 antenna is suitable for wall and mast mounting outdoors. The PSI-GSM/UMTS-QB-ANT antenna is ideal for mounting on a control cabinet.



External antenna



Control cabinet antenna

Ordering data		
Type	Order No.	Pcs. / Pkt.
PSI-GSM/UMTS-ANT-OMNI-2-5	2900982	1

Accessories		
Type	Order No.	Pcs. / Pkt.
PSI-CAB-GSM/UMTS- 5M	2900980	1
PSI-CAB-GSM/UMTS-10M	2900981	1

Ordering data		
Type	Order No.	Pcs. / Pkt.
PSI-GSM/UMTS-QB-ANT	2313371	1

Accessories		
Type	Order No.	Pcs. / Pkt.
PSI-CAB-GSM/UMTS- 5M	2900980	1
PSI-CAB-GSM/UMTS-10M	2900981	1

Description
Multiband antenna for external panel and external mast mounting for UMTS and quad-band GSM, with omnidirectional characteristics, 5 m antenna cable with SMA round connector
Multi-band antenna for UMTS and quad band GSM, with omnidirectional characteristic, 2 m antenna cable with SMA round connector, degree of protection: IP65, dimensions: 76 x 20 mm

Antenna extension cable for UMTS and quad-band GSM, with SMA connector and SMA coupling 5 m long
10 m long

Surge protection

Mobile communication surge protection

- For GSM networks with 850 MHz, 900 MHz, 1800 MHz, and 1900 MHz as well as UMTS networks

SHDSL surge protection

- For broadband communication devices



For GSM systems (0.8 GHz - 2.25 GHz), grounded shield, connection: SMA



Attachment plug for two VDSL interfaces (ports)

Ordering data		
Type	Order No.	Pcs. / Pkt.
CSMA-LAMBDA/4-2.0-BS-SET	2800491	1

Ordering data		
Type	Order No.	Pcs. / Pkt.
DT-TELE-RJ45	2882925	1

Description
Surge protection for UMTS and quad-band GSM antenna, with SMA connector and SMA coupling
DATATRAB , protective adapter for insertion in the data cable

SUBCON.../SUBCON-PLUS... D-SUB fast connection connector



Now also with M12 connection technology

The new SUBCON-PLUS-M12 fieldbus connectors combine the D-SUB connection typically used for IP20 with the M12 connector. This connector has long been used with IP65 modules.

High EMC shielding effect

The connector range SUBCON-..., trimmed to the smallest dimensions, provides high shielding against EMC influences in industrial environments by virtue of its metallic housing.

Convenient connection technology

An idea has taken hold - absolutely no soldering or crimping tools: the D-SUB plugs, SUBCON... can be connected quickly and conveniently in field conditions. The plug contacts are clearly routed onto consecutively numbered screw terminal blocks. This means clarity during wiring and it simplifies every startup.

Optional cable infeed

The connection block can be inserted in either the upper or lower shell. This allows the cable to be fed in at 0° to 90° from right or left.

This allows on-site configuration of the cable infeed and requires only one order number with the order.

A wide product range

Irrespective of whether the application requires 9, 15 or 25-pos. plugs with one or two cable entries for point-to-point or RS-485 bus connections, a suitable version is available for each and every application. Optimized designs for PROFIBUS, CANopen® and SafetyBUSp with the right cables and tools complete the comprehensive range.

Customer-specific solutions

Does your application need an exclusive solution? We would be pleased to provide you with an offer based on our know-how. Of course, space can be made for your own company logo in the plastic parts.

PROFIBUS cables and fast connection tools for SUBCON-PLUS-PROFIBUS

If the Fast Connect cable PSM-CABLE-PPROFIB/FC is used, work is reduced to a minimum by using the quick stripping tool, **PSM-STRIP-FC/PROFIB**:

- strip cables and individual wires
- insert them into the plug, and
- close the housing cover.



PROFIBUS cable, type Fast Connect



Quick stripping tool for SUBCON-PLUS-PROFIBUS connectors

Cable cross section (max./min.)
 Ambient temperature (operation)
 Loop resistance
 Working capacitance
 Wave impedance
 Conductor
 Cross section
 Outer sheath, material
 External sheath, color
 Behavior in fire
 Resistance to oil
 Cable type
 Operations per knife block

Technical data	
Cable cross section (max./min.)	8.4 mm / 7.6 mm
Ambient temperature (operation)	-40 °C ... 60 °C
Loop resistance	≤ 110 Ω (per kilometer)
Working capacitance	28.5 nF (per kilometer)
Wave impedance	150 Ω ±15 %
Conductor	Solid copper wire, bare
Cross section	0.34 mm ² / AWG 22
Outer sheath, material	PVC FR VI
External sheath, color	Violet
Behavior in fire	Flame-resistant as per IEEE and IEC 60 332-3 test type C
Resistance to oil	Limited resistance to mineral oils and greases
Cable type	PROFIBUS according to IEC 61158, Type A
Operations per knife block	-

Technical data	
Cable cross section (max./min.)	-
Ambient temperature (operation)	-
Loop resistance	-
Working capacitance	-
Wave impedance	-
Conductor	-
Cross section	-
Outer sheath, material	-
External sheath, color	-
Behavior in fire	-
Resistance to oil	-
Cable type	-
Operations per knife block	-
	PUR cable: max. 300 per knife block
	PVC cable: max. 3000 per knife block

Description
PROFIBUS cable, Fast Connect type , up to 12 Mbps, for permanent connection (02YSY (ST)CY 1X2X22 AWG) (length in meters as per customer specifications)
Quick stripping tool for PROFIBUS cable, Fast Connect type

Ordering data		
Type	Order No.	Pcs. / Pkt.
PSM-CABLE-PROFIB/FC	2744652	1

Ordering data		
Type	Order No.	Pcs. / Pkt.
PSM-STRIP-FC/PROFIB	2744623	1

Spare knife block for quick stripping tool	blue
Stripping tool , for conductors and cables	black

Accessories		
Type	Order No.	Pcs. / Pkt.
QUICK WIREFOX 6	1204384	1

Accessories		
Type	Order No.	Pcs. / Pkt.
PSM-STRIP-KNIFEBLOCK	2744636	1
QUICK WIREFOX 6	1204384	1

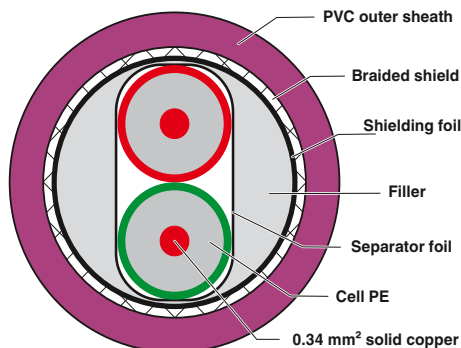

Fast connection technology

SUBCON-PLUS-M12- fast connection

The new SUBCON-PLUS fast connection plugs with M12 connection ensure error-free installation of bus systems, thanks to the use of fully-tested components, such as cables and connection plugs.

The innovative housing concept is lightweight yet offers optimum mechanical protection against environmental influences. This means that the fast connection plugs are ideal, even in applications subject to vibration.

The unique SPEEDCON fast locking system on the M12 connections offers reliable connection with just half a turn.

Features:

- Easy startup, plug and play
- Light weight
- Termination using M12 termination resistor
- Adapter between IP20 and IP67 environments
- For PROFIBUS and CANopen® systems

Advantages:

- Direct connection of M12 cables
- Complete range with versions for every application
- Problem-free installation, thanks to 100% tested individual components
- Fully molded housing
- M12-SPEEDCON locking, connected securely with just half a turn

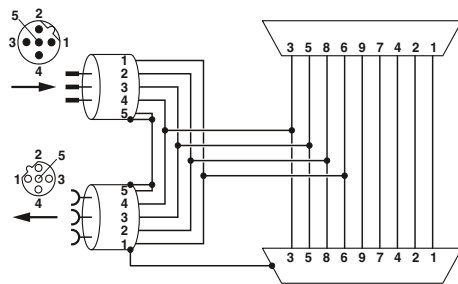

SUBCON-PLUS-PROFIB/...M12 function block diagram

General data	
Cable entry	
Ambient temperature (operation)	
Degree of protection	
Housing material	
Number of positions	
Termination resistor	
SUBCON fixing	
Dimensions	W / H / D

Description	
Fast connection plugs , for PROFIBUS systems, Pin assignment 3, 5, 6, 8	
- Standard version	
Pg version with programming connection	
Fast connection plugs , for CAN-based systems, Pin assignment 2, 3, 5, 7, 9	
- Standard version	
Pg version with programming connection	

PROFIBUS termination resistor	
- M12 pin design	
- M12 socket design	
Bus cable PROFIBUS , straight socket, shielded, M12 B-coded, 2-pos., straight pin, shielded, M12 B-coded, 2-pos.	
- Cable length 1 m	
- Variable cable length	
DeviceNet™/CANopen® termination resistor	
- M12 pin design	
- M12 socket design	
Bus cable DeviceNet™/CANopen , straight socket, shielded, M12 A-coded, 5-pos., straight pin, shielded, M12 A-coded, 5-pos.	
- Cable length 1 m	
- Variable cable length	

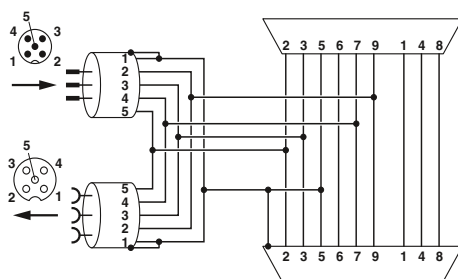

SUBCON-PLUS-CAN/...M12 function block diagram

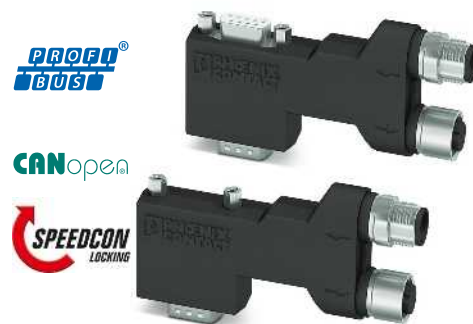

90° version, long,
Suitable for Siemens S7

Technical data	
90° (left)	
-30 °C ... 80 °C	
IP40	
Polyamide	
5	
Separately via M12 termination resistor	
4-40 UNC 0.4 Nm	
16 mm / 41 mm / 93 mm	

Ordering data		
Type	Order No.	Pcs. / Pkt.
SUBCON-PLUS-PROFIB/90X/M12	2902729	1
SUBCON-PLUS-PROFIB/90X/PG/M12	2902728	1
SUBCON-PLUS-CAN/90X/M12	2902731	1
SUBCON-PLUS-CAN/90X/PG/M12	2902730	1

Accessories		
Type	Order No.	Pcs. / Pkt.
SAC-5P-M12MS PB TR	1507803	5
SAC-5P-M12FS PB TR	1403911	1
SAC-2P-MSB/ 1,0-910/FSB SCO	1518122	1
SAC-2P-MSB-FSB SCO/910/...	1538092	1
SAC-5P-M12MS CAN TR	1507816	5
SAC-5P-M12FS CAN TR	1529344	5
SAC-5P-MS/ 1,0-920/FS SCO	1518274	1
SAC-5P-MS-FS SCO/920/...	1538157	1

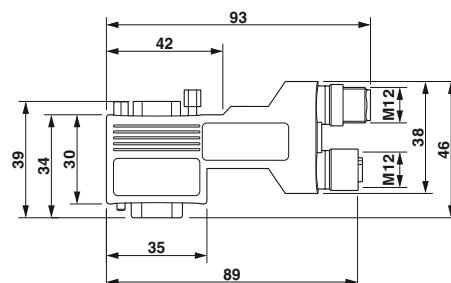

SUBCON-PLUS...90X...M12 dimensional drawing,
long 90° version

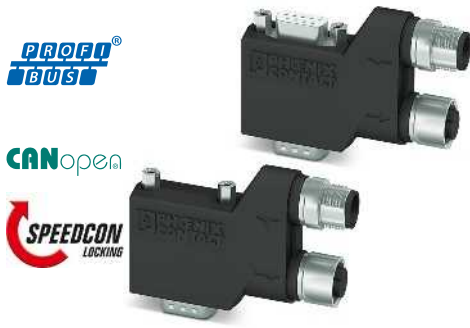

90° version, short, Universal



35° version, Universal



Axial version, universal

Technical data
90° (left)
-30 °C ... 80 °C
IP40
Polyamide
5
Separately via M12 termination resistor
4-40 UNC 0.4 Nm
16 mm / 40 mm / 71 mm

Technical data
35° (left)
-30 °C ... 80 °C
IP40
Polyamide
5
Separately via M12 termination resistor
4-40 UNC 0.4 Nm
16 mm / 46 mm / 79 mm

Technical data
180° (axial)
-30 °C ... 80 °C
IP40
Polyamide
5
Separately via M12 termination resistor
4-40 UNC 0.4 Nm
16 mm / 75 mm / 38 mm

Ordering data		
Type	Order No.	Pcs. / Pkt.
SUBCON-PLUS-PROFIB/90/M12	2902318	1
SUBCON-PLUS-PROFIB/90/PG/M12	2902317	1
SUBCON-PLUS-CAN/90/M12	2902323	1
SUBCON-PLUS-CAN/90/PG/M12	2902322	1

Ordering data		
Type	Order No.	Pcs. / Pkt.
SUBCON-PLUS-PROFIB/35/M12	2902320	1
SUBCON-PLUS-PROFIB/35/PG/M12	2902319	1
SUBCON-PLUS-CAN/35/M12	2902325	1
SUBCON-PLUS-CAN/35/PG/M12	2902324	1

Ordering data		
Type	Order No.	Pcs. / Pkt.
SUBCON-PLUS-PROFIB/AX/M12	2902321	1
SUBCON-PLUS-CAN/AX/M12	2902326	1

Accessories		
Type	Order No.	Pcs. / Pkt.
SAC-5P-M12MS PB TR	1507803	5
SAC-5P-M12FS PB TR	1403911	1
SAC-2P-MSB/ 1,0-910/FSB SCO	1518122	1
SAC-2P-MSB-FSB SCO/910/...	1538092	1
SAC-5P-M12MS CAN TR	1507816	5
SAC-5P-M12FS CAN TR	1529344	5
SAC-5P-MS/ 1,0-920/FS SCO	1518274	1
SAC-5P-MS-FS SCO/920/...	1538157	1

Accessories		
Type	Order No.	Pcs. / Pkt.
SAC-5P-M12MS PB TR	1507803	5
SAC-5P-M12FS PB TR	1403911	1
SAC-2P-MSB/ 1,0-910/FSB SCO	1518122	1
SAC-2P-MSB-FSB SCO/910/...	1538092	1
SAC-5P-M12MS CAN TR	1507816	5
SAC-5P-M12FS CAN TR	1529344	5
SAC-5P-MS/ 1,0-920/FS SCO	1518274	1
SAC-5P-MS-FS SCO/920/...	1538157	1

Accessories		
Type	Order No.	Pcs. / Pkt.
SAC-5P-M12MS PB TR	1507803	5
SAC-5P-M12FS PB TR	1403911	1
SAC-2P-MSB/ 1,0-910/FSB SCO	1518122	1
SAC-2P-MSB-FSB SCO/910/...	1538092	1
SAC-5P-M12MS CAN TR	1507816	5
SAC-5P-M12FS CAN TR	1529344	5
SAC-5P-MS/ 1,0-920/FS SCO	1518274	1
SAC-5P-MS-FS SCO/920/...	1538157	1

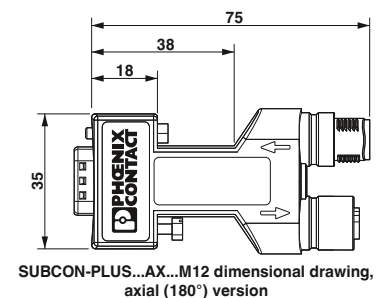
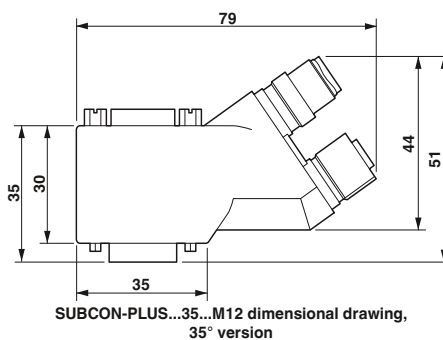
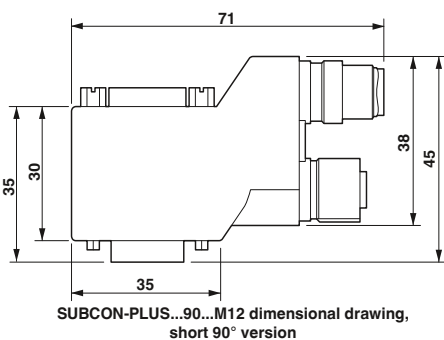

Fast connection technology

SUBCON-PLUS-PROFIBUS D-SUB fast connection

PROFIBUS plugs with fast connection

The D-SUB series, **SUBCON-PLUS-PROFIB/...** was specially designed for use in PROFIBUS systems up to 12 Mbps. Under field conditions, it allows convenient and fast connection of the incoming and outgoing bus cable.

The product range includes nine fast connectors - the perfect solution for every PROFIBUS application:

- 35° and 90° angled cable entry
- Axial cable entry
- With an additional programming interface
- Integrated surge protection

The plugs can be used for PROFIBUS cables with massive as well as with stranded copper wires.

The termination resistor is already integrated in all versions. It can be connected externally by means of a slide switch. At the same time, the outgoing bus segment is switched off. This makes it easy to start up segment by segment while incorrect terminations are avoided.

In addition, the connector housing with high-quality shielding guarantees high immunity to interference even at maximum transmission speeds.

A special feature of the 35° angled connector is that the internal connection unit can be turned round. Whether the cable is to be inserted from the right or left can thus be decided on-site.

If it is not possible to use the angled version, the SUBCON-PLUS.../AX compact plug with axial cable entry can be used instead.

The plugs are designed to be used for all standard PROFIBUS cables with 8 mm external diameter (types A and B).



35° PROFIBUS connector plug, screw connection, reversible cable entry



General data	
Cable entry	35° (right or left)
Connection cross section (solid / stranded / AWG)	0.14 - 1.5 mm ² / 0.14 - 1 mm ² / 26 - 16
Insertion/withdrawal cycles	> 200
Cable cross section (max./min.)	8.4 mm / 7.6 mm
Ambient temperature (operation)	-20 °C ... 75 °C
Degree of protection	IP40
Housing material	ABS, metal-plated
Termination resistor	390 Ω / 220 Ω / 390 Ω (can be connected externally)
SUBCON fixing	4-40 UNC 0.4 Nm

Technical data		
35° (right or left)		
0.14 - 1.5 mm ² / 0.14 - 1 mm ² / 26 - 16		
> 200		
8.4 mm / 7.6 mm		
-20 °C ... 75 °C		
IP40		
ABS, metal-plated		
390 Ω / 220 Ω / 390 Ω (can be connected externally)		
4-40 UNC 0.4 Nm		

Description	
PROFIBUS connector , up to 12 Mbps, integrated termination resistor which can be activated externally, 9-pos. pin, pin assignment 3, 5, 6, 8	
- Angled 35°, screw connection	
- Angled 35°, screw connection with second D-SUB socket	
- Angled 35°, screw connection, with surge protection	
- Angled 90°, screw connection	
- Angled 90°, screw connection with second D-SUB socket	
- Angled 90°, IDC connection	
- Angled 90°, IDC connection with second D-SUB socket	
- Axial cable entry, screw connection	
- Axial cable entry, spring-cage connection	

Ordering data		
Type	Order No.	Pcs. / Pkt.
SUBCON-PLUS-PROFIB/SC2	2708232	1
SUBCON-PLUS-PROFIB/PG/SC2	2708245	1
D-UFB-PB	2880642	1

PROFIBUS cable, Fast Connect type , up to 12 Mbps, for permanent connection (02YSY (ST)CY 1X2X22 AWG) (length in meters as per customer specifications)
Quick stripping tool for PROFIBUS cable, Fast Connect type

Accessories		
PSM-CABLE-PROFIB/FC	2744652	1
PSM-STRIP-FC/PROFIB	2744623	1

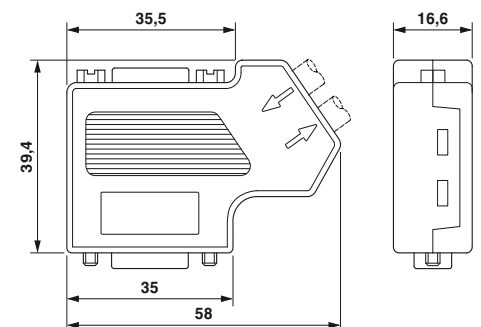



90° PROFIBUS connector plug,
screw connection



90° PROFIBUS connector plug,
IDC insulation displacement connection
method



Axial PROFIBUS connector plug,
screw or spring-cage connection



Technical data
90° (left)
0.14 - 1.5 mm ² / 0.14 - 1 mm ² / 26 - 16
> 200
8.4 mm / 7.6 mm
-20 °C ... 75 °C
IP40
ABS, metal-plated
390 Ω / 220 Ω / 390 Ω (can be connected externally)
4-40 UNC 0.4 Nm

Technical data
90° (left)
0.32 - 1 mm ² / 0.32 - 1 mm ² / 22 - 18
> 200
8.4 mm / 7.6 mm
-20 °C ... 75 °C
IP40
ABS, metal-plated
390 Ω / 220 Ω / 390 Ω (can be connected externally)
4-40 UNC 0.4 Nm

Technical data
180° (axial)
0.14 - 1.5 mm ² / 0.14 - 1 mm ² / 26 - 16
> 200
8.4 mm / 7.6 mm
-20 °C ... 75 °C
IP40
ABS, metal-plated
390 Ω / 220 Ω / 390 Ω (can be connected externally)
4-40 UNC 0.4 Nm

Ordering data		
Type	Order No.	Pcs. / Pkt.
SUBCON-PLUS-PROFIB/90/SC	2313698	1
SUBCON-PLUS-PROFIB/90/PG/SC	2313708	1

Ordering data		
Type	Order No.	Pcs. / Pkt.
SUBCON-PLUS-PROFIB/90/IDC	2313672	1
SUBCON-PLUS-PROFIB/90/PG/IDC	2313685	1

Ordering data		
Type	Order No.	Pcs. / Pkt.
SUBCON-PLUS-PROFIB/AX/SC	2744380	1
SUBCON-PLUS-PROFIB/AX	2744377	1

Accessories		
PSM-CABLE-PROFIB/FC	2744652	1
PSM-STRIP-FC/PROFIB	2744623	1

Accessories		
PSM-CABLE-PROFIB/FC	2744652	1
PSM-STRIP-FC/PROFIB	2744623	1

Accessories		
PSM-CABLE-PROFIB/FC	2744652	1
PSM-STRIP-FC/PROFIB	2744623	1

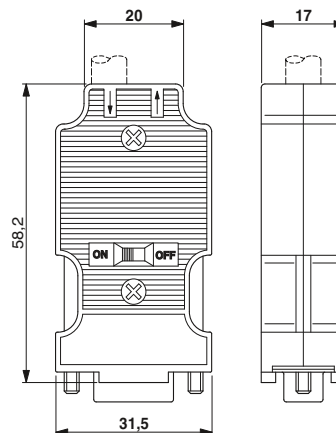
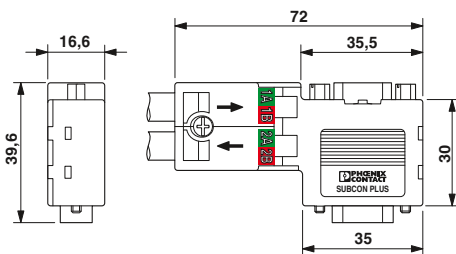
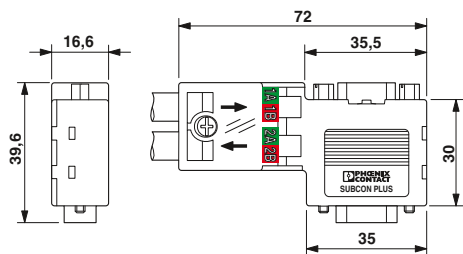

Fast connection technology

SUBCON-PLUS-CAN D-SUB fast connection connector

The SUBCON-PLUS-CAN/... D-SUB series is specially designed for use in CAN systems. Under field conditions, it enables the quick and easy connection of the incoming and outgoing bus cable.

The termination resistor is already integrated in all versions. It can be connected externally by means of a slide switch. At the same time, the outgoing bus segment is switched off. This makes it easy to start up segment by segment while incorrect terminations are avoided. In addition, the connector housing with high-quality shielding guarantees high immunity to interference even at maximum transmission speeds.

A special feature of the angled plug is that the internal connection unit can be turned round. Whether the cable is to be inserted from the right or left can thus be decided on-site. If it is not possible to use the angled design, a compact plug with axial cable entry is available with the SUBCON-PLUS-CAN/AX type.

Features:

- Assembly under field conditions
- Separate terminal blocks for bus cables
- Termination resistor can be connected
- Segment-by-segment startup
- High transmission speed
- High level of EMC
- Flexibility in terms of cable entry selection
- Suitable for bus cables as per the CiA Draft Recommendation 303-1 with an outside diameter of 8 mm
- For special cables, there is a version with a variable cable entry

Versions:

- Angled with programming interface
- Angled without programming interface
- Axial cable entry

CANopen

SafetyBUS p



35° D-SUB plug (socket), screw connection, two cable entries



Technical data

General data	
Cable entry	35° (right or left)
Pin assignment	2, 3, 7, 9
Nominal voltage U_N	5 V
Nominal current I_N	100 mA
Connection cross section (solid / stranded / AWG)	0.14 - 1.5 mm ² / 0.14 - 1 mm ² / 26 - 16
Insertion/withdrawal cycles	> 200
Cable cross section (max./min.)	8.4 mm / 7.6 mm
Ambient temperature (operation)	-20 °C ... 75 °C
Degree of protection	IP40
Housing material	ABS, metal-plated
Termination resistor	120 Ω (can be connected externally)
SUBCON fixing	4-40 UNC 0.4 Nm

Ordering data

Type	Order No.	Pcs. / Pkt.
SUBCON-PLUS-CAN/SC2	2708999	1
SUBCON-PLUS-CAN/PG	2708119	1

Accessories

SZS 0,4X2,5 VDE	1205037	10
-----------------	---------	----

Description

CAN, CANopen, SafetyBUS p connector, integrated termination resistor that can be activated from the outside, with screw connection, 9-pos., socket

- 35° angled
- Angled 35°, with second D-SUB connection
- Angled 35°, for variable cable diameters

CAN, CANopen, SafetyBUS p connector, integrated termination resistor that can be activated from the outside, with screw connection, 9-pos., socket

- axial cable entry

Screwdriver

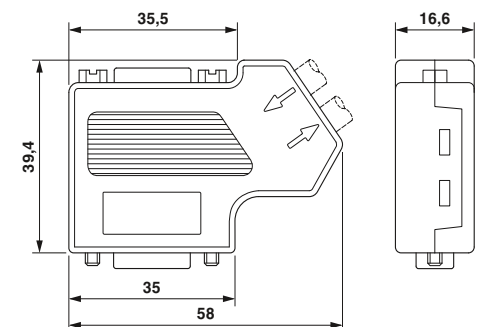

CANopen



CANopen



SafetyBUS p



SafetyBUS p



35° D-SUB plug (socket),
variable cable diameter

Axial D-SUB plug (socket),
two cable entries

UL US ENEC

UL US

Technical data
35° (right or left)
2,3,7
5 V
100 mA
0.14 - 1.5 mm ² / 0.14 - 1 mm ² / 26 - 16
> 200
10 mm / 6 mm
-20 °C ... 75 °C
IP40
ABS, metal-plated
120 Ω (can be connected externally)
4-40 UNC 0.4 Nm

Technical data
180° (axial)
2, 3, 7
5 V
100 mA
0.14 - 0.5 mm ² / 0.14 - 0.5 mm ² / 26 - 20
> 200
8.4 mm / 7.6 mm
-20 °C ... 75 °C
IP40
ABS, metal-plated
120 Ω (can be connected externally)
4-40 UNC 0.4 Nm

Ordering data		
Type	Order No.	Pcs. / Pkt.
SUBCON-PLUS-CAN	2744694	1

Ordering data		
Type	Order No.	Pcs. / Pkt.
SUBCON-PLUS-CAN/AX	2306566	1

Accessories		
SZS 0,4X2,5 VDE	1205037	10

Accessories		
SZS 0,4X2,5 VDE	1205037	10

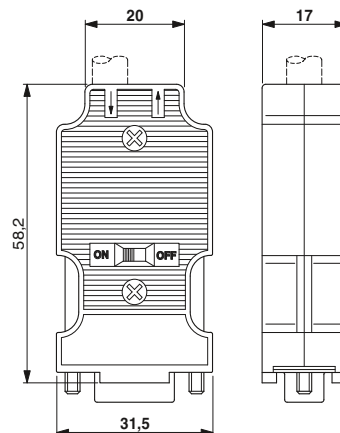
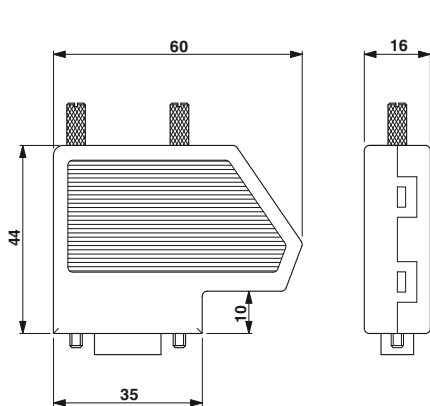

Fast connection technology

SUBCON-PLUS

D-SUB fast connection connector

Field bus connector with screw connection

Two cable infeeds are often required on the D-SUB plugs used in order to build fieldbus systems with RS-485 interfaces. The SUBCON-PLUS plugs range fulfills this requirement and routes the connection to screw terminal blocks – however, duplicated – for two cables. This means clarity during wiring and it simplifies every startup. These plugs are of course also shielded against EMC influences with a metallized housing. In addition, by placing the connection block in either the upper or lower shell, it is possible to select the cable infeed on site from the right or left.

Features:

- For universal use
- Assembly under field conditions
- Separate terminal blocks for each cable
- High transmission speed
- High level of EMC
- Flexibility in terms of cable entry selection
- Straightforward assembly thanks to knurled screws

Versions:

- Bus-specific types with matching partial assignment
- Universal type with full assignment
- Short mounting screw as an accessory for confined spaces

Nominal voltage U_N
 Nominal current I_N
 Connection cross section (solid / stranded / AWG)
 Insertion/withdrawal cycles
 Cable cross section (max./min.)
 Ambient temperature (operation)
 Degree of protection
 Housing material
 SUBCON fixing

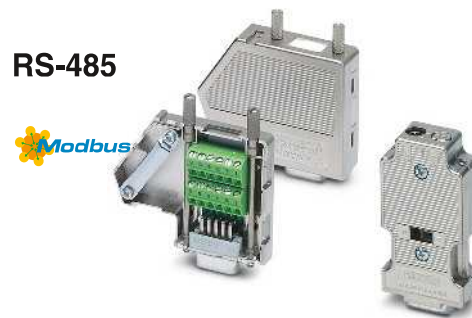

RS-485



With two cable entries,
35° angled and axial



Technical data

50 V
 100 mA
 0.14 - 1.5 mm² / 0.14 - 1 mm² / 26 - 18
 > 200
 10 mm / 6 mm
 -20 °C ... 75 °C
 IP20
 ABS, metal-plated
 4-40 UNC 0.4 Nm

Ordering data

Type	Order No.	Pcs. / Pkt.
SUBCON-PLUS M1	2761826	1
SUBCON-PLUS F1	2744267	1
SUBCON-PLUS M2	2761839	1
SUBCON-PLUS F2	2799490	1
SUBCON-PLUS F5	2744102	1
SUBCON-PLUS 9/M	2744018	1
SUBCON-PLUS 9/F	2744241	1
SUBCON-PLUS-M/AX 9	2904467	1
SUBCON-PLUS-F/AX 9	2311797	1

Accessories

SUBCON-SHORT-SCREW	2799694	1
SZS 0,4X2,5 VDE	1205037	10

Description
D-SUB connector , with two cable entries for MODBUS, MODBUS-PLUS, BITBUS, ARCNET, MULT/MININET (B&R), SYSTEM 2003 (B&R), P-NET, pin assignment 1,2,3,5,6,8
- Angled 35°, 9-pos., pin - Angled 35°, 9-pos., socket
D-SUB connector , with two cable entries for SUCONET K1, K2 (EATON/Moeller), S-BUS (Saia), J-BUS (Merlin Gerin), pin assignment 2, 3, 4, 5, 7, 9
- Angled 35°, 9-pos., pin - Angled 35°, 9-pos., socket
D-SUB connector , with two cable entries for MODBUS, CELELEC, pin assignment 1,1,2,3,6,7
- Angled 35°, 9-pos., socket
D-SUB plug , with two cable entries, universal type , pin assignment 1,2,3,4,5,6,7,8,9 on every screw terminal block
- Angled 35°, 9-pos., pin - Angled 35°, 9-pos., socket - Axial, 9-pos., pin - Axial, 9-pos., socket

Optional mounting screw , short (without knurl)
Screwdriver

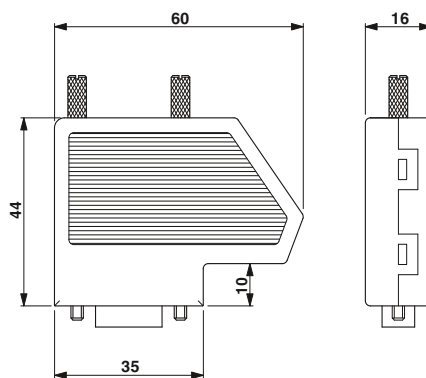

Dimensional drawing SUBCON-PLUS...

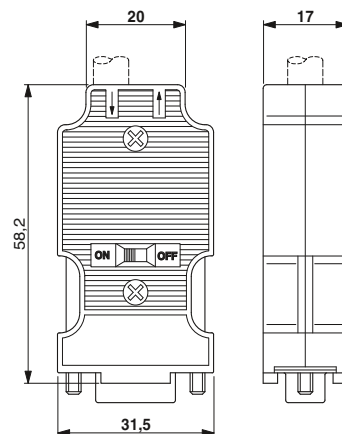

Dimensional drawing SUBCON-PLUS.../AX...

SUBCON
D-SUB fast connection connector

The 9-pos. version of the SUBCON-... connector range is not just suitable for INTERBUS, but is positively ideal. A whole host of further applications are opened up by having all the connections assigned to their own 1 mm² screw terminal block.

The range covers SUBCON plugs for point-to-point connections with a cable infed in 9, 15 and 25-pos. pin or socket versions.

Installing the connection block either in the upper or lower shell makes it possible to introduce the cable at an angle of 0° to 90° from the right or the left. The completely metallized housing also ensures a high degree of shielding against EMC influences.

The optional fastening screw SUBCON-SHORT-SCREW is available as an accessory for narrow installation conditions. The screw is completely integrated into the housing by not having a knurl.

Features:

- For universal use
- Assembly under field conditions
- High level of EMC
- Flexibility in terms of cable entry selection
- Straightforward assembly thanks to knurled screws

Versions:

- 9-, 15-, and 25-pos. versions
- Short mounting screw as an accessory for confined spaces

Cable entry
Pin assignment
Nominal voltage U _N
Nominal current I _N
Connection cross section (solid / stranded / AWG)
Insertion/withdrawal cycles
Cable cross section (max./min.)
Ambient temperature (operation)
Degree of protection
Housing material
SUBCON fixing

Description
D-SUB plug , with screw connection
- 9-pos., socket
- 9-pos., pin
D-SUB plug , with screw connection
- 15-pos., socket
- 15-pos., pin
D-SUB plug , with screw connection
- 25-pos., socket
- 25-pos., pin

Optional mounting screw , short (without knurl)
Screwdriver

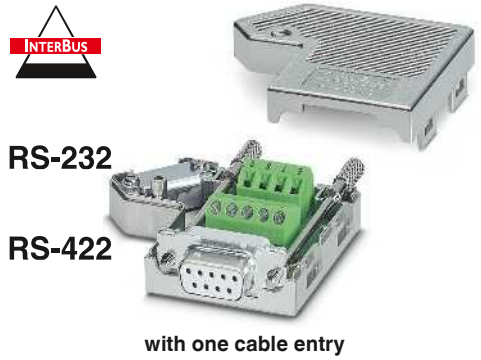

Technical data	
35° (right or left)	
All connections are 1:1 on the screw terminal block	
50 V	
100 mA	
0.14 - 1.5 mm ² / 0.14 - 1 mm ² / 26 - 16	
> 200	
10 mm / 4 mm	
-20 °C ... 75 °C	
IP20	
ABS, metal-plated	
4-40 UNC 0.4 Nm	

Ordering data		
Type	Order No.	Pcs. / Pkt.
SUBCON 9/F-SH	2761499	1
SUBCON 9/M-SH	2761509	1
SUBCON 15/F-SH	2761596	1
SUBCON 15/M-SH	2761606	1
SUBCON 25/F-SH	2761619	1
SUBCON 25/M-SH	2761622	1

Accessories		
SUBCON-SHORT-SCREW	2799694	1
SZS 0,4X2,5 VDE	1205037	10

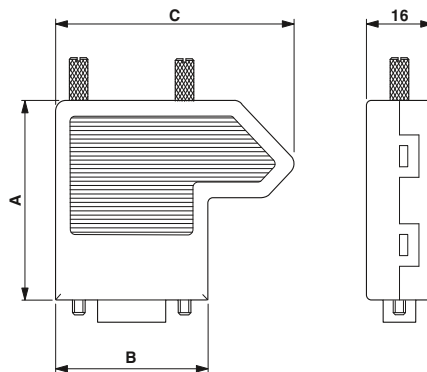

Dimensional drawing SUBCON...-SH

Dimensions [mm] of the D-SUB plug-in connectors (SUBCON)

	A	B	C
9-pos.	44.5	36.0	56.4
15-pos.	44.5	44.3	64.7
25-pos.	49.5	58.0	78.7

Fast connection technology

RS-232 cables

A permanent cause of annoyance are the two connection standards, 9 and 25-pin for the RS-232 interface. The plug-in "9 to 25-pos." D-SUB adapters solve the problem without complicated resoldering of the cable connections.

The 0.5 and 2 meter standard RS-232 cables can be used to connect the rail-mountable control cabinet modules. Individual lengths can be created quickly and simply with the screw-type D-SUB plug, SUBCON.

Null modem adapter

In order to connect two RS-232 interfaces of the same type, the zero modem plug crosses the data and control lines.

Thanks to the small "Gender Changer" type, it can be plugged at any interface directly and thus does not change the existing connector design through the socket/connector combination.



RS-232 connecting cable

Description
RS-232-D-SUB cable , length: 0.5 m - 9-pos. socket on 9-pos. socket
RS-232-D-SUB cable , length: 2 m - 9-pos. socket on 9-pos. socket
RS-232-D-SUB cable , length: 2 m - 9-pos. socket on 25-pos. socket

RS-232 null modem adapter
- 9-pos. socket to 9-pos. male connector
D-SUB gender changer
- 9-pos., pin/pin
- 9-pos., socket/socket
- 25-pos., pin/pin
- 25-pos., socket/socket

Ordering data		
Type	Order No.	Pcs. / Pkt.
PSM-KA9SUB9/BB/0,5METER	2708520	1
PSM-KA9SUB9/BB/2METER	2799474	1
PSM-KA 9 SUB 25/BB/2METER	2761059	1

Accessories		
Type	Order No.	Pcs. / Pkt.
PSM-AD-D9-NULLMODEM	2708753	1
VS-09-GC-ST/ST	1652651	10
VS-09-GC-BU/BU	1688722	10
VS-25-GC-ST/ST	1652693	10
VS-25-GC-BU/BU	1652680	10

USB cable adapter

Two adapter cables with a length of 1 m and 3 m are available for connecting controllers, PCs and other automation devices with USB-A connections to devices with Mini-USB-B connections.



USB cable (USB-A to mini-USB)

Description
USB cable , from USB-A to Mini-USB-B, 5-pos.
- Length: 1 m
USB connecting cable (individual) for configuration
- Length: 3 m
USB cable , for diagnostics and extended configuration

Ordering data		
Type	Order No.	Pcs. / Pkt.
PSI-CA-USB A/MINI B/1METER	2313575	1
CABLE-USB/MINI-USB-3,0M	2986135	1
RAD-CABLE-USB	2903447	1

RS-485 connection distributor

If spur connections or a star distribution are to be made in a bus system, the RS-485 connection distributors come to your aid.

PSM-PTK, the DIN rail-mountable T-adaptor equipped with three 9-pin 1:1 connected D-SUB connections, makes for clear and tidy wiring with just one spur connection.

As many as four branch lines can be picked off from one bus line in the PSM-PTK 4 version. Here too, all six D-SUB connections (9-pos.) are connected through 1:1. Both versions are mounted by snapping them onto conventional EN DIN rails.

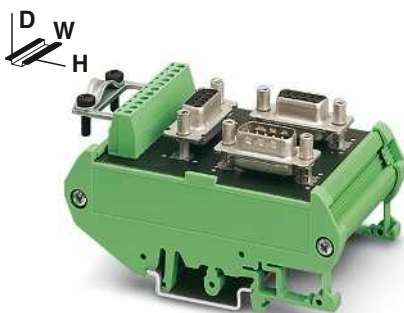

**RS-485 T-distributor (4-way),
D-SUB and screw connection**

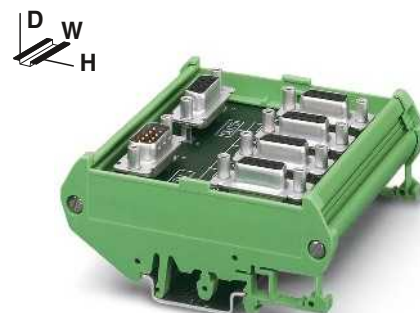

**RS-485 T-distributor (6-way),
D-SUB connection**

UL vs. EAC

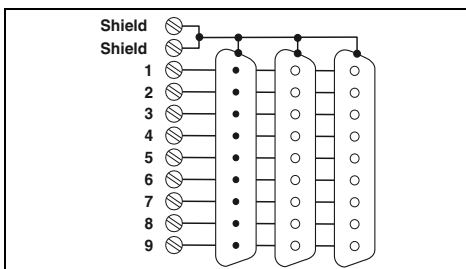

Technical data

Plug connection	Incoming	D-SUB-9 plug
	Outgoing	D-SUB-9 socket
	Branching	D-SUB-9 socket
		1x 11-pos. PCB terminal block
Nominal voltage U_N		60 V AC/DC
Nominal current I_N		1 A
Test voltage		500 V AC (50 Hz, 1 min, rms)
Shield connection		D-SUB frame or shield connector
Screw connection	solid	0.14 mm ² - 1 mm ²
	stranded	0.14 mm ² - 1.5 mm ²
	AWG	26 - 16
Torque		0.4 Nm
Ambient temperature (operation)		-25 °C ... 70 °C
Housing material		PVC
Pin assignment		all 1:1
Dimensions W / H / D		56 mm / 89.6 mm / 48 mm

ERC

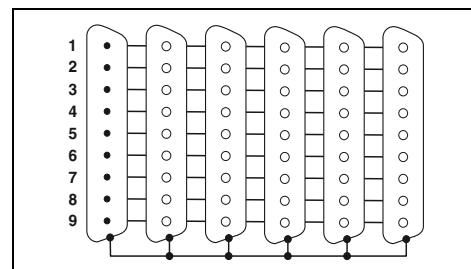

Technical data

		D-SUB-9 plug
		D-SUB-9 socket
		4 x D-SUB-9 socket
		-
Nominal voltage U_N		60 V AC/DC
Nominal current I_N		1 A
Test voltage		500 V AC (50 Hz, 1 min, rms)
Shield connection		D-SUB frame
Screw connection		-
		-
		-
Ambient temperature (operation)		-25 °C ... 70 °C
Housing material		PVC
Pin assignment		all 1:1
Dimensions W / H / D		89.8 mm / 89.6 mm / 39 mm

Ordering data

Description	Type	Order No.	Pcs. / Pkt.
Passive RS-485 T-distributor , fitted with a 9-pos. D-SUB pin and two 9-pos. D-SUB sockets, as well as a 9-pos. PCB terminal block with shield connector	PSM PTK	2760623	1
Passive RS-485 T-distributor , fitted with one 9-pos. D-SUB pin and five 9-pos. D-SUB sockets			

Ordering data

Description	Type	Order No.	Pcs. / Pkt.
Passive RS-485 T-distributor , fitted with one 9-pos. D-SUB pin and five 9-pos. D-SUB sockets	PSM PTK-4	2799364	1

Accessories

Accessories	Order No.	Pcs. / Pkt.
Screwdriver	SZS 0,4X2,5 VDE	1205037 10

Accessories

Accessories	Order No.	Pcs. / Pkt.
Screwdriver	SZS 0,4X2,5 VDE	1205037 10



Process infrastructure

Process infrastructure connects the control level to the field level via modern fieldbuses, I/O modules, and wireless communication systems.

Modern process technology, including WirelessHART, FOUNDATION Fieldbus, PROFIBUS PA, and I/O solutions for potentially explosive areas can be used in numerous different industries, including mining, water/waste water, and oil and gas. Phoenix Contact offers flexible solutions for all applications and customer requirements.

- Process infrastructure is suitable for all applications and environments
- Failure times are reduced thanks to high integrity and hot swapping
- Multifunctional remote I/Os enable greater flexibility
- Remote access to error diagnostics means that hazardous areas do not have to be entered
- Approvals for all applications

Product overview	420
<hr/>	
Process fieldbus	
Field junction boxes	423
Device couplers for the field	425
Power supply	429
Field diagnostic modules	430
Accessories	431
<hr/>	
Inline Ex i	
Intrinsically safe I/Os for the ex area	432

Product overview

Process fieldbus



Field connection boxes in stainless steel
Page 423



Field connection boxes in aluminum
Page 423



Device couplers for the field
Page 425



Device couplers for field devices
Page 426



Power supply
Connector for the power supply
Page 429



Power supply
Base for the power supply
Page 429



Power supply
1-channel power supply
Page 429



Field diagnostic modules for
FOUNDATION Fieldbus
Page 430

Accessories



Double wire protection for floating signal
circuits
Page 431

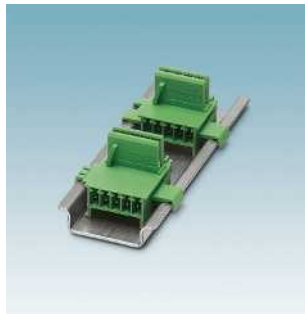

TBUS connector
Page 431

Inline Ex i – intrinsically safe I/Os for the hazardous area



Intrinsically safe power supply terminal
Page 432



Intrinsically safe digital I/O terminals
Page 433



Intrinsically safe analog I/O terminals
Page 433



Intrinsically safe temperature input terminal
Page 433

Wireless data communication



WirelessHART gateway

Page 506



WirelessHART adapter

Page 507



Radioline wireless modules

Page 499

Surge protection for measurement and control technology



• See Catalog 6 – LINETRAB and MCR-PLUGTRAB – surge protection for Ex i circuits

i Your web code: #0292



• See Catalog 6 – TERMITRAB – terminal blocks (intrinsically safe) with multi-stage surge protection

i Your web code: #0292



• See Catalog 6 – SURGETRAB – field devices directly at the sensor head (intrinsically safe)

i Your web code: #0292

Measurement and control technology



• See Catalog 7 – Ex i signal conditioners with functional safety

i Your web code: #0293



• See Catalog 7 – Ex i 2-wire field devices

i Your web code: #0294



The FB... line of modular fieldbus components offers connectivity from the process controller to the field devices. Together with redundant bulk power, surge protection, and cabling cordsets, a complete connection architecture is provided.

The line includes device couplers for use with both Foundation Fieldbus and PROFIBUS PA. These couplers provide short-circuit protection to ensure that a fault on a spur does not disrupt the entire segment. They also offer energy limited outputs, intrinsic safety and electrical isolation.

Also available are redundant and simplex power supplies. Each electrically isolated supply provides power while allowing digital communications to one segment. Passive power conditioning allows for high reliability, and high efficiency eliminates derating in any mounting configuration.

Field junction boxes provide a ready to install solution. These boxes, in either stainless steel or aluminum, are specifically designed to accommodate the modular device couplers and ease wiring considerations.

Based on the T-bus connection system, the field components are hot-swappable and allow easy system expansion. Single-loop-integrity can be achieved by connection of a single module to a single instrument. With the limited width on the rail, the size and weight of the associated field enclosure is minimized.

The FB... line was designed specifically to meet the tough requirements of the process environment. This includes various approvals for installation in Zone 2 or Division 2 hazardous locations.

All components include built-in status LEDs. Integrated terminators in the power supplies, together with a connector-mounted version in the field, reduce the opportunity for segment termination error.

Typical Foundation Fieldbus H1-Segment

Control Cabinet

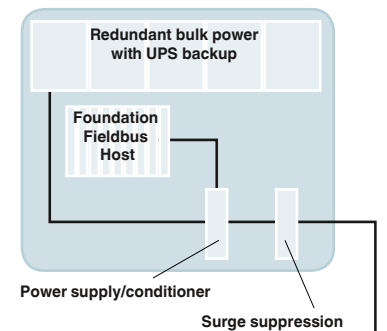

Field (Zone 2/Division 2)

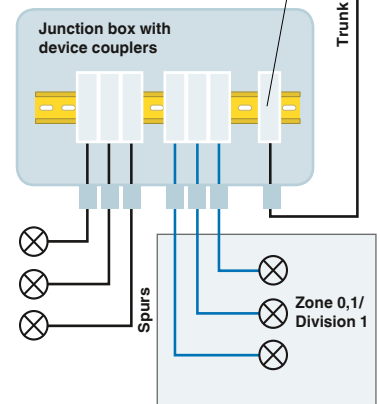

Field junction boxes

- Designed specifically for field device coupler systems
- Includes trunk module FB-ET and allows installation of additional couplers and PT plug
- Bus bar and shield clamps
- Entries for trunk in, trunk out and, breather connections
- Each enclosure is equipped with M20 ports and can be configured as desired
- Cable glands, plugs, and breather ordered separately



Stainless steel enclosure



Aluminum enclosure

General data	
Housing material	
DIN rail, material	
Weight	
Dimensions	W / H / D
Mounting position	
Degree of protection	
Ambient temperature (operation)	
Conformance / approvals	
ATEX	

Technical data	
FB-9-SS	FB-15-SS
Stainless steel, 316L, electropolished	
NS35, galvanized, passivated	
4439 g	4700 g
235 mm / 260 mm / 121 mm	325 mm / 300 mm / 121 mm
Vertical	
IP66 / NEMA 4X	
-40 °C ... 85 °C	
Ex II 2 G/2 D	

Technical data	
FB-8-AL	FB-15-AL
Aluminum, die-cast, corrosion resistant, powder-coated	
NS35, galvanized, passivated	
2980 g	4094.6 g
202 mm / 232 mm / 111 mm	330 mm / 230 mm / 111 mm
Vertical	
IP66 / NEMA 4X	
-40 °C ... 85 °C	
Ex II 2 G/2 D	

Description	
Enclosure, stainless steel	
- 9 ports	
- 15 ports	
Enclosure, aluminum	
- 8 ports	
- 15 ports	

Ordering data		
Type	Order No.	Pcs. / Pkt.
FB-9-SS	2316213	1
FB-15-SS	2316190	1

Ordering data		
Type	Order No.	Pcs. / Pkt.
FB-8-AL	2316200	1
FB-15-AL	2316187	1

Cable gland , M20, includes nut	
Stopping plug , M20, includes nut	
Breather plug , M20, includes nut	

Accessories		
FB-M-KV-M20-EX	2900197	1
FB-M-BS-M20-EX	2900209	10
FB-M-BD-M20-EX	2901859	1

Accessories		
FB-M-KV-M20-EX	2900197	1
FB-M-BS-M20-EX	2900209	10
FB-M-BD-M20-EX	2901859	1

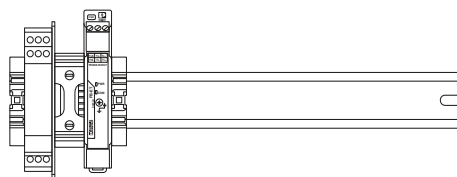
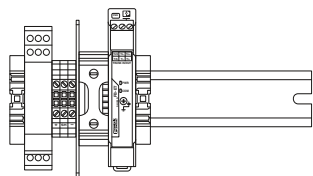

DIN rail components, small enclosure vs. large enclosure



The fieldbus device couplers are suitable for Foundation Fieldbus and PROFIBUS PA. They provide an interface between the fieldbus trunk line and field devices. The compact width on the DIN rail reduces the required dimensions and weight of the field housing.

FB-ET

- Connects to the trunk and provides voltage limiting
- Includes a pre-installed external terminator, ensuring termination is always available
- A selector switch is provided to select the correct shield/ground connection
- Diagnostic LEDs include DC OK, low voltage warning, and communication on the segment. External terminator includes a connection LED

FB-2SP and FB-ISO

- Couple field devices and provide short-circuit current limiting with a user-selectable setpoint
- Voltage and communication are routed via the ME 17,5 TBUS... connectors installed on the DIN rail
- Provide non-incendive, FISCO ic and FNICO spur connections
- Hot-swappable and scalable
- Single-sided connector configuration simplifies wiring in field housing
- Can be installed together in the same field housing
- Diagnostic LEDs indicate DC OK and errors at the spur connection

FB-ISO only

- Comprehensive channel-to-channel electrical isolation
- Provides an intrinsically safe, FISCO connection
- Single-loop integrity is achieved by the connection of a single FB-ISO coupler to a single device. With dedicated circuitry for each device, the redundancy achieved by the segment power supply is not compromised

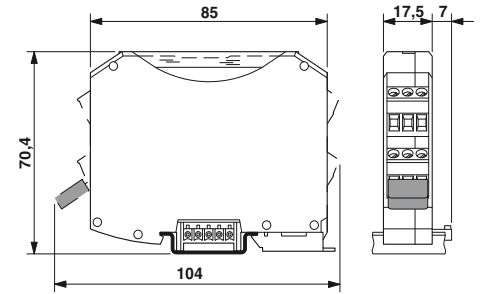

Supply
Supply voltage range

Rated current

Nominal current consumption

Fieldbus interface

Rated voltage

Rated current

Electrical isolation

Termination resistor

Surge protection

General data

Screw connection solid / stranded / AWG

Dimensions

W / H / D

Degree of protection

Ambient temperature (operation)

Max. permissible relative humidity (operation)

Conformance / approvals

Conformance

NE

ATEX

IECEX

CSA, USA/Canada

Fieldbus Foundation

Description

Device coupler, for Foundation Fieldbus and PROFIBUS PA



Device coupler with TBUS for trunk line connection and termination

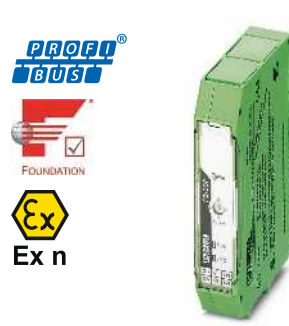

Device coupler with TBUS for 2 spurs

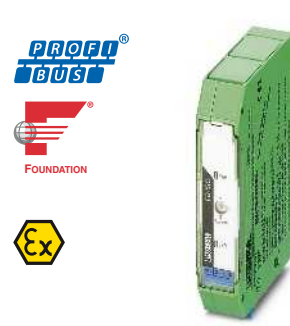

Device coupler with TBUS for 1 electrically isolated spur connection

Ex:

Ex:

Ex:

Technical data
10.3 V DC ... 32 V DC (input on trunk line side)
≤ 1 A (trunk line input side to TBUS)
8 mA (without termination resistor)
-
-
100 Ω, external removable plug included Active if voltage exceeds 39 V (typ.) or 41 V (max.)
0.2 - 2.5 mm ² / 0.2 - 2.5 mm ² / 24 - 12 17.5 mm / 99.1 mm / 70.4 mm IP20 -40 °C ... 85 °C
95 % (non-condensing)
CE-compliant, additionally EN 61326 NAMUR NE 21 II 3 G Ex nA IIC T4 Gc
Ex nA IIC T4 Gc
Class I, Zone 2, AEx nA IIC T4 Class I, Division 2, Groups A,B,C,D FF-846

Technical data
10.3 V DC ... 32 V DC (input on trunk line side)
-
6 mA
≤ 32 V (each spur) 15 mA (each spur, adjustable via selector switch, -40...85°C) 25 mA (each spur, adjustable via selector switch, -40...80°C) 35 mA (each spur, adjustable via selector switch, -40...75°C) 45 mA (each spur, adjustable via selector switch, -40...70°C)
-
-
500 V AC (between input and output, routine test)
-
-
0.2 - 2.5 mm ² / 0.2 - 2.5 mm ² / 24 - 12 17.5 mm / 89.7 mm / 70.4 mm IP20 -40 °C ... 85 °C (depending on set rated current)
95 % (non-condensing)
CE-compliant, additionally EN 61326 NAMUR NE 21 II 3(3) G Ex nA [nL Gc] IIB T4 Gc, FNICO spurs II 3(3) G Ex nA [ic Gc] IIB T4 Gc, FISCO ic spurs
Ex nA [nL Gc] IIB T4 Gc, FNICO spurs Ex nA [ic Gc] IIB T4 Gc, FISCO ic spurs
Class I, Zone 2, AEx nA[nL] IIB T4 Class I, Div. 2, Groups C, D FF-846

Technical data
17 V DC ... 32 V DC (input on trunk line side)
-
10 mA
≥ 10 V (each spur) 15 mA (each spur, adjustable via selector switch) 25 mA (each spur, adjustable via selector switch) 35 mA (each spur, adjustable via selector switch)
500 V AC (between input and output, routine test)
-
-
0.2 - 2.5 mm ² / 0.2 - 2.5 mm ² / 24 - 12 17.5 mm / 89.7 mm / 70.4 mm IP20 -40 °C ... 70 °C
95 % (non-condensing)
CE-compliant, additionally EN 61326 NAMUR NE 21 II 3(3) G Ex nA [nL Gc] IIC T4 Gc, FNICO power supply (spur) II 3(1) GD Ex nA [ia Ga Da] IIC T4 Gc, FISCO power supply (spur)
Ex nA [nL Gc] IIC T4 Gc, FNICO power supply (spur) Ex nA [ia Ga Da] IIC T4 Gc, FISCO power supply (spur)
CSA applied for

Ordering data		
Type	Order No.	Pcs. / Pkt.
FB-ET	2316048	1

Ordering data		
Type	Order No.	Pcs. / Pkt.
FB-2SP	2316051	1

Ordering data		
Type	Order No.	Pcs. / Pkt.
FB-ISO	2316064	1

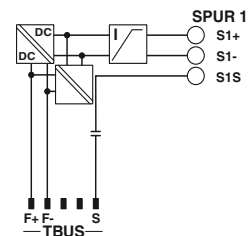
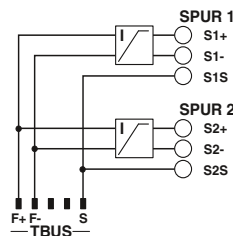
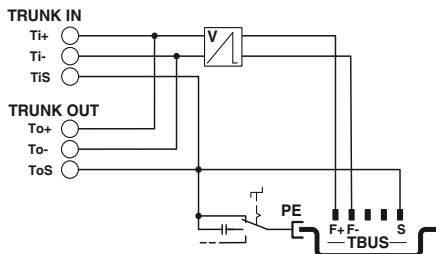

Device couplers for field devices

- Couple field devices and provide short-circuit current limiting
- Provide non-sparking and FISCO ic spur connections
- Single-sided connection configuration simplifies wiring in field housing
- Diagnostic LEDs indicate DC OK and errors at the spur connection
- Fulfills the requirements of EN 60079-0:2012, EN 60079-11:2012, EN 60079-15:2005, and EN 60079-15:2010.

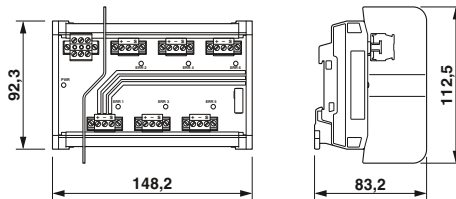

Device couplers for 6 and 12 spurs

Ex:

Supply	
Supply voltage range	
Rated current	
Nominal current consumption	
Fieldbus interface	
Rated voltage	
Rated current	
Termination resistor	
General data	
Screw connection solid / stranded / AWG	
Dimensions	W / H / D
Degree of protection	
Ambient temperature (operation)	
Max. permissible relative humidity (operation)	
Conformance / approvals	
NE	
ATEX	
IECEX	
CSA, USA/Canada	
Fieldbus Foundation	

Technical data	
FB-6SP	FB-12SP
Supply voltage range 10.5 V DC ... 32 V DC (input on trunk line side)	
Rated current ≤ 2 A	
Nominal current consumption 4.8 mA	6.5 mA
Rated voltage ≤ 32 V (each spur)	
Rated current 38 mA	38 mA
Termination resistor 100 Ω, external removable plug included	
General data	
Screw connection solid / stranded / AWG 0.2 - 2.5 mm ² / 0.2 - 2.5 mm ² / 24 - 12	
Dimensions 148.2 mm / 112.5 mm / 83.5 mm 254.1 mm / 112.5 mm / 83.5 mm	
Degree of protection IP20	
Ambient temperature (operation) -50 °C ... 90 °C	
Max. permissible relative humidity (operation) < 95 % (non-condensing)	
Conformance / approvals	
NE Sira 13ATEX4247X; II 3(3)G Ex nA [ic] IIC T4 Gc; Entity/FISCO ic spurs Ex nA [nL] IIC T4 Gc; II 3G Ex ic IIC T4 Gc, FISCO ic IECEX SIR 13.0089X; Ex nA [ic] IIC T4 Gc, Entity/FISCO ic spurs; Ex nA [nL] IIC T4 Gc; Ex ic IIC T4 Gc, FISCO ic	
CSA, USA/Canada Class I, Div. 2, Groups A, B, C, D; Ex nA [nL] IIC T4; Class I, Zone 2, AEx nA [nC] IIC T4	
Fieldbus Foundation FF-846	

Description	
Device coupler, for Foundation Fieldbus and PROFIBUS PA	
- 6 spurs	
- 12 spurs	

Ordering data		
Type	Order No.	Pcs. / Pkt.
FB-6SP	2316307	1
FB-12SP	2316310	1

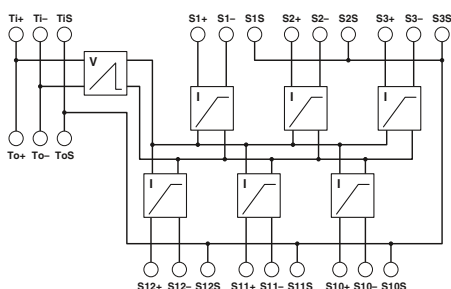

Connection diagram: FB-6SP

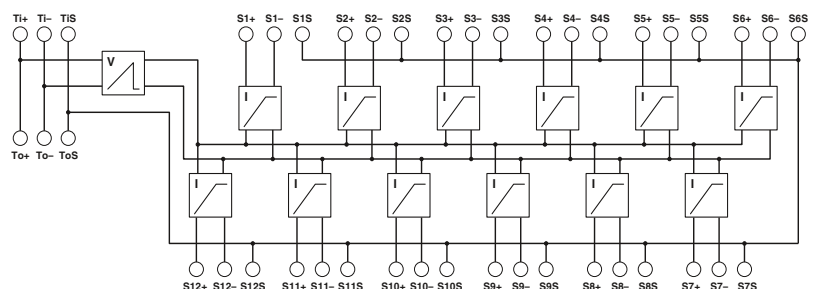

Connection diagram: FB-12SP

Converter

The PROFIBUS DP to PA coupler link provides both a powerful and reliable interface to interconnect PROFIBUS DP into the process fieldbus network PROFIBUS PA.

- Integrated PA terminator
- 500 mA PA current
- Expandable to 9 PA modules
- Transparent data transfer
- Integrated webserver for configuration and diagnostics
- Integrated oscilloscope functionality

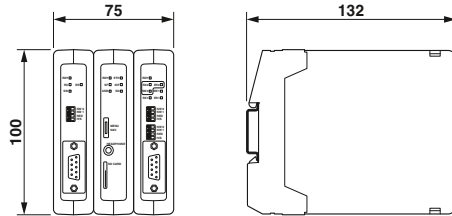

Supply	
Supply voltage range	10.8 V DC ... 26.4 V DC
Ethernet interface	
Description	10/100 Mbps Ethernet
Connection method	RJ45
General data	
Screw connection solid / stranded / AWG	0.2 - 2.5 mm ² / 0.2 - 2.5 mm ² / 24 - 12
Dimensions	W / H / D 75 mm / 100 mm / 132 mm
Degree of protection	IP20
Ambient temperature (operation)	-20 °C ... 60 °C
Conformance / approvals	
UL, USA / Canada	UL 508 Listed

Technical data

Supply	
Supply voltage range	10.8 V DC ... 26.4 V DC
Ethernet interface	
Description	10/100 Mbps Ethernet
Connection method	RJ45
General data	
Screw connection solid / stranded / AWG	0.2 - 2.5 mm ² / 0.2 - 2.5 mm ² / 24 - 12
Dimensions	W / H / D 75 mm / 100 mm / 132 mm
Degree of protection	IP20
Ambient temperature (operation)	-20 °C ... 60 °C
Conformance / approvals	
UL, USA / Canada	UL 508 Listed

Ordering data

Description	Ordering data		
	Type	Order No.	Pcs. / Pkt.
Converter	FB-HSB-DP/PA	2316370	1

Accessories

Description	Accessories		
	Type	Order No.	Pcs. / Pkt.
Repeater	FB-DP-RPTR	2316373	1
Repeater	FB-PA/SC	2316375	1



Each DIN rail-mounted fieldbus power supply provides high-integrity power for one H1 segment. Built-in output impedance allows digital communication and DC power to co-exist on a pair of wires.

- Electrically isolated
- Integrated termination resistor
- Passive filtering allows for low heat dissipation and long service life
- Plug-in connectors and local diagnostic LEDs permit easy installation and troubleshooting

FB-PS... modular redundant power supply

- Modular base, one per segment, eliminates unused capacity
- Swappable bases for increased plant integrity
- Compact width optimizes critical enclosure space
- Redundant power modules, with common conditioning in the base, provides greatest system performance and reliability
- Quick-latch modules and base
- Preventative function monitoring: self diagnostics with output relay integrated in each power module. Eliminates need for separate diagnostics and contact module
- Dedicated relay connection per base
- Bussable power and relay through plug-in side-base connectors
- Redundant host connections to common segment
- Redundant power connections feed each power module separately
- Auto Current Balance technology enhances product life by closely sharing power between modules
- High efficiency including MOSFET outputs

FB-PS... simplex power supply

- Connections for redundant bulk power
- Power is bussed to the power supply through the TBUS
- No space required between modules to optimize enclosure size

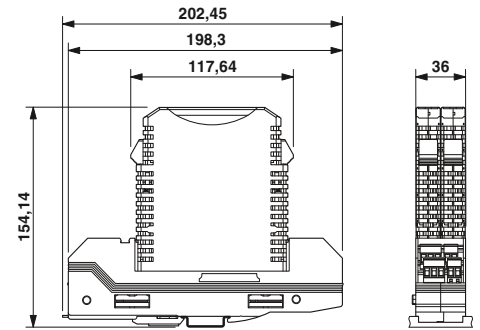

Input data	
Nominal current range	
Output data	
Output voltage range	
Output current	
Can be connected in Parallel / series	
Max. power dissipation	
Signaling	
Signaling DC OK	
Signaling alarm	
Signaling overload	
Redundancy indication OK	
General data	
Dimensions	W / H / D
Degree of protection	
Ambient temperature (operation)	
Ambient temperature (storage/transport)	
Max. permissible relative humidity (operation)	
Conformance / approvals	
ATEX	
UL, USA / Canada	
NE	
EN	
Fieldbus Foundation	

Description	
Power supply, modular redundant	
- Plug, 28 V DC, 500 mA	
- Base	
Power supply, simplex, with built-in 100 Ω termination	
- 25 V DC, 360 mA	

PCB connector, 5.0 mm pitch, color: black	
PCB connector, 3.5 mm pitch, color: green	
End cap	

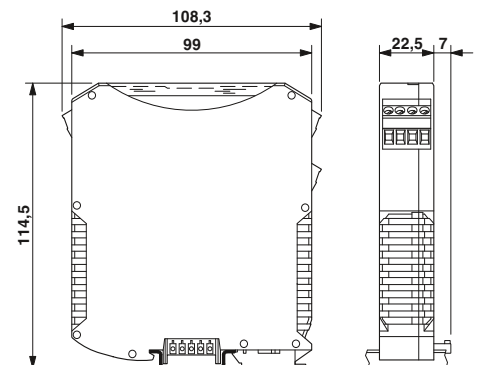

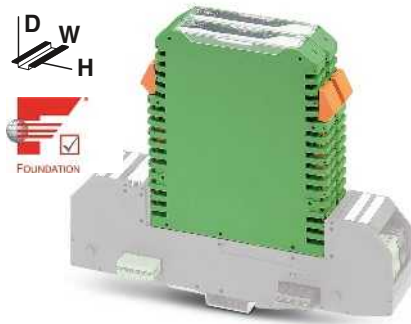

Power supply plug

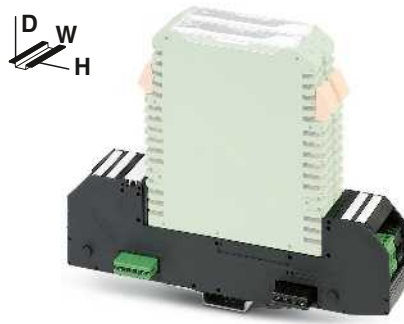

Power supply base



Simplex power supply

Technical data
700 mA ... 1100 mA
28 V DC ... 30 V DC (on the trunk)
500 mA
Yes / No
4 W (typical)
Green LED
Yellow LED
-
Green LED
17.5 / 117.6 / 115 mm
IP20
-40 °C ... 70 °C
-40 °C ... 85 °C
95 % (non-condensing)
-
-
NAMUR NE 21
EN 61326
FF-831

Technical data
-
-
- / -
-
-
-
36 / 202.5 / 61.5 mm
IP20 (when D-FB-PS is installed)
-40 °C ... 70 °C
-40 °C ... 85 °C
95 % (non-condensing)
-
-
NAMUR NE 21
EN 61326
FF-831

Technical data
340 mA ... 630 mA
25 V DC ... 27 V DC (on the trunk)
360 mA
- / -
2 W (typical)
Green LED
-
LED red
-
22.5 / 114.5 / 108.3 mm
IP20
-40 °C ... 60 °C
-40 °C ... 85 °C
95 % (non-condensing)
Ex II 3 G Ex nA II T4 X
Class I, Zone 2, Group IIC T4
Class I, Div. 2, Groups A, B, C, D, T4
NAMUR NE 21
EN 61326, EN 60068-2-27, EN 60068-2-6
FF-831

Ordering data		
Type	Order No.	Pcs. / Pkt.
FB-PS-PLUG-24DC/28DC/0.5/EX	2316132	1

Ordering data		
Type	Order No.	Pcs. / Pkt.
FB-PS-BASE/EX	2316145	1

Ordering data		
Type	Order No.	Pcs. / Pkt.
FB-PS-25/0.36A	2316035	1

Accessories		

Accessories		
ZEC 1,5/ 4-LPV-5,0 C2,4 BK	1793260	50
ZEC 1,0/ 6-LPV-3,5 C1	1915699	50
D-FB-PS	2316226	10

Accessories		

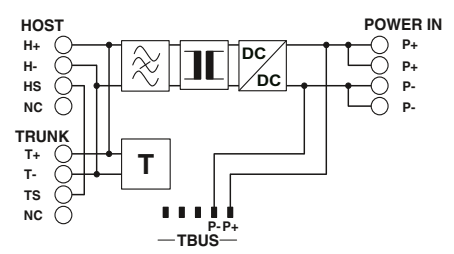
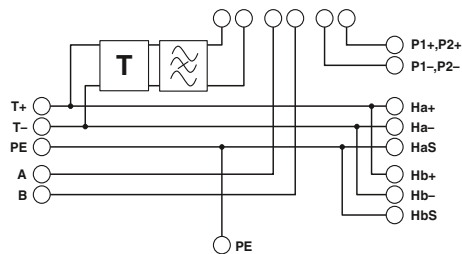
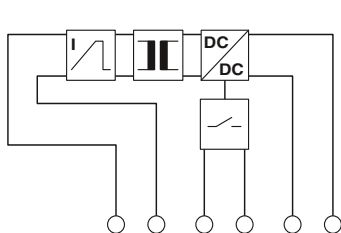

Process fieldbus

Field diagnostic modules for Foundation Fieldbus

- Reads physical layer diagnostics in the field
- Segment voltage, noise and signal can be monitored
- Easy control system integration with DD and EDDL
- Adjustable alarm condition thresholds allow for precision monitoring and trending
- Diagnostics data for up to 24 field devices
- Two module types for easy integration across all system platforms



With terminal block for FF power supply and/or block coupler applications



For modular device couplers mounted on TBUS

Ex:

Ex:

Technical data	
Supply	
Supply voltage range	9 V DC ... 32 V DC
Nominal current consumption	27 mA
Fieldbus interface	
Rated voltage	≤ 32 V
Rated current	29 mA
General data	
Screw connection solid / stranded / AWG	0.2 - 2.5 mm ² / 0.2 - 2.5 mm ² / 24 - 12
Dimensions	W / H / D 17.7 mm / 93.9 mm / 70.4 mm
Degree of protection	IP20
Ambient temperature (operation)	-40 °C ... 85 °C
Max. permissible relative humidity (operation)	95 % (non-condensing)
Conformance / approvals	
Fieldbus Foundation	FF-830

Technical data	
Supply	
Supply voltage range	9 V DC ... 32 V DC
Nominal current consumption	27 mA
Fieldbus interface	
Rated voltage	≤ 32 V
Rated current	29 mA
General data	
Screw connection solid / stranded / AWG	0.2 - 2.5 mm ² / 0.2 - 2.5 mm ² / 24 - 12
Dimensions	W / H / D 17.7 mm / 85 mm / 70.4 mm
Degree of protection	IP20
Ambient temperature (operation)	-40 °C ... 85 °C
Max. permissible relative humidity (operation)	95 % (non-condensing)
Conformance / approvals	
Fieldbus Foundation	FF-830

Ordering data		
Type	Order No.	Pcs. / Pkt.
FB-DIAG/FF/LI	2316284	1

Ordering data		
Type	Order No.	Pcs. / Pkt.
FB-DIAG/FF/LI	2316284	1

Ordering data		
Type	Order No.	Pcs. / Pkt.
FB-DIAG/FF/NC	2316297	1

Ordering data		
Type	Order No.	Pcs. / Pkt.
FB-DIAG/FF/NC	2316297	1

Accessories

- Surge protection in input
- The DIN rail connector ME 22.5 TBUS bridges input power between several simplex power supplies (FB-PS-25/0.36A).
- **Note:** The modular device couplers already include the required TBUS connector ME 17.5, so a separate order is not necessary.



Double wire protection for floating signal circuits



TBUS connector

Description	Ordering data			Ordering data		
	Type	Order No.	Pcs. / Pkt.	Type	Order No.	Pcs. / Pkt.
SURGETRAB protective adapter for installation on measuring sensors for Ex protection zones Outer thread: M20 x 1.5	S-PT-EX-24DC	2800034	1			
PLUGTRAB , plug-in surge protection for Foundation Fieldbus						
Protective plug Base element with bridge between 3/4 (±) and 9/10	PT 2X2-FF-ST	2800755	10			
	PT 4-BE	2839402	10			
Base element with gas-filled surge arrester between 3/4 (±) and 9/10	PT 4+F-BE	2839415	10			
DIN rail connector				ME 22,5 TBUS 1,5/ 5-ST-3,81 GN	2707437	50

Accessories

- End clamp, ground and shield clamps (CLIPLINE)
- Terminal block bases that can be lined up next to each other in order to set up any number of positions
- Marking material



Clamps and terminal blocks



Marking materials

Description	Color	Ordering data			Ordering data		
		Type	Order No.	Pcs. / Pkt.	Type	Order No.	Pcs. / Pkt.
End clamp , to snap on NS 35, 9.5 mm wide, can be labeled with ZB 6, ZB 8/27, KLM...	gray	CLIPFIX 35	3022218	50			
		E/ME TBUS NS35 GY	2713780	50			
Terminal block	gray	UT 2,5	3044076	50			
Cover , width 2.2 mm	gray	D-UT 2,5/10	3047028	50			
Shrink sleeve , for conductor diameters 3.2 - 9.5 mm							
1 roll = 500 marker, à 30 mm long	white				WMS 9,5 (30X16)R	0800377	1
UniCard , for marking terminal blocks with a marker groove, 32-section, 4 individual labels per strip, for a terminal block width of 16 mm	white				UC-TM 16	0819217	10
UniCard , for marking terminal blocks with a flat marker groove, 32-section, 4 individual labels per strip, for a terminal block width of 16 mm	white				UC-TMF 16	0819262	10

Inline Ex i

Intrinsically safe I/Os for the ex area

The Inline **IB IL EX-IS PWR IN-PAC** terminal allows the implementation of intrinsically safe I/O modules in the modular Inline I/O system. Intrinsically safe (blue) I/O terminals can only operate with the specific voltage levels provided by the IL EX-IS PWR IN-PAC terminal.

The **IB IL EX-IS DIO 4/NAM-PAC** terminal allows connection of intrinsically safe sensors/actuators as well as NAMUR sensors located in zone 1 or zone 0 Ex areas. The terminal has 4 channels that can be configured as either an input or output.

The **IB IL EX-IS AIO 4/EF-PAC** terminal allows connection of intrinsically safe analog sensors and actuators located in Ex areas like Zone 1 or Zone 0. The terminal has 4 channels that can be configured as either an input or output.

The **IB IL EX-IS TEMP 4 RTD/TCPAC** terminal allows connection of resistance temperature detectors (RTD) and thermocouples (TC) located in zone 1 or zone 0 Ex areas. The terminal has 4 channels that can be configured for either an RTD or TC sensor.

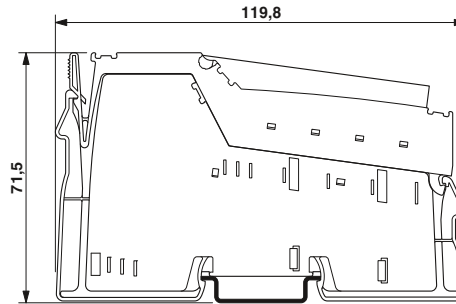

Power terminal for intrinsically safe terminals

Ex: Ex

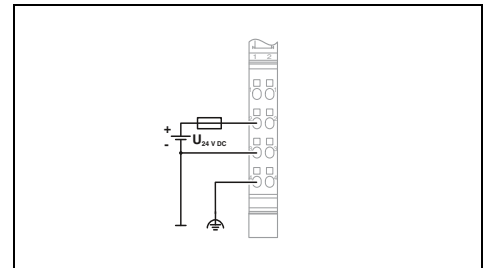

Technical data

Local bus interface	
Connection method	Inline data jumper
Power supply for module electronics	
Supply for main circuit U_{Ex}	28 V DC $\pm 5\%$
Power supply at U_{Ex}	1000 mA (max.)
Current consumption from U_{Ex}	-
Communications power U_L	5 V DC (via potential jumper)
Power supply at U_L	1000 mA (max.)
Current consumption from U_L	-
Digital inputs	
Connection method	-
Input circuit	-
Protective circuit	-
Digital outputs	
Connection method	-
Description of the outputs	-
Analog inputs	
Connection method	-
Voltage input signal	-
Current input signal	-
Analog outputs	
Connection method	-
Current output signal	-
Protective circuit	-
Temperature input	
Sensor types (RTD) that can be used	-
Sensor types that can be used (TC)	-
Linear resistance measuring range	-
Measured value resolution	-
Data formats	-
Protective circuit	-
General data	
Connection method	Spring-cage connection
Connection data solid / stranded / AWG	0.08 ... 1.5 mm ² / 0.08 ... 1.5 mm ² / 28 - 16
Width	48.8 mm
Ambient temperature (operation)	-25 °C ... 60 °C
EMC note	Class A product, see page 527

Ordering data

Description	Type	Order No.	Pcs. / Pkt.
Inline terminal, Ex-i, complete with accessories (connector plug and marking field) 4-channel DIO	IB IL EX-IS PWR IN-PAC	2869910	1



Software

Software is the key to more efficient automation. Phoenix Contact offers software from configuration to system operation – intelligent solutions that guide you through every stage of the value added chain of your automation solution. All products interact perfectly and impress with their innovative functions and intuitive, user-friendly operation. In addition, a wide range of ready-to-use block libraries is also available.

Programming

Software products for programming, from small to medium-sized applications with small-scale controllers to complex system automation with high-end PLCs.

Visualization

Intelligent tools for designing operation and monitoring interfaces – in the control room or directly in the machine.

Data management systems

Software for the central management of all process data. I.e., data acquisition, archiving, and evaluation using the same software.

Configuration, monitoring, diagnostics

Software tools for fast startup, constant monitoring, and reliable diagnostics.

Device parameterization

Central and efficient – parameterize your field devices from the comfort of your PC.

Drivers and interfaces

Everything you need to connect additional systems to your automation solution.

Planning and configuration

Expert support with the planning and configuration of technical components. So that everything works together perfectly.

Remote control

Flexible solutions for controlling distributed automation units.

System simulation

Startup and testing made easy – in a completely virtual environment.

Marking software

Software tools for efficient marking – even in series production.

Product overview	436
Programming	
PC Worx Express/PC Worx	438
nanoNavigator	440
Function blocks/libraries	485
Visualization	
WebVisit	441
Visu+	442
atvise® SCADA	444
Data management	
Acron	445
Configuration, monitoring, diagnostics	
Config+	446
Diag+	448
AIP	450
Device parameterization	
Startup+	451
Drivers and interfaces	
OPC server	452
Planning and configuration	
Project+	454
Remote control	
Portico	455
Resy+	485

Software

Product overview

Programming



PC Worx – software package for Phoenix Contact controllers programmed according to IEC 61131

Page 438



Steeplechase VLC – development environment with flowchart programming and hardware key

 Your web code: #0295



NanoNavigator – programming software for the Nanoline product range

Page 440



Logic+ – intuitive programming software for quick and easy configuration

- See Catalog 7 - relay modules section

Visualization



atvise® SCADA – software for SCADA visualization

Page 444

Data management



Acron – software for data management systems

Page 445

Configuration, monitoring, and diagnostics



Config+ – tool for fieldbus and network configuration

Page 446



Diag+ – diagnostics software for INTERBUS, PROFINET, and Ethernet networks

Page 448

Device parameterization



Startup+ – software for wiring checks on Axioline F I/O stations

Page 451



FL MGuard DM ... – central management software for FL MGuard devices

Page 323



SAFECONF – configuration software for TRISAFE and SafetyBridge modules

Page 88



PSR-CONF-WIN – configuration software for PSR-RSM4 with connecting cable

Page 89

Planning and configuration



Project+ – software for planning the I/O configuration

Page 454

Remote control

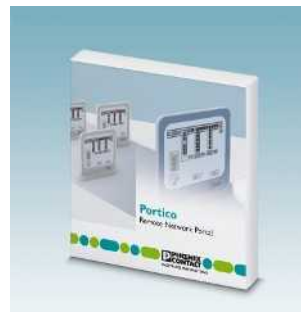

VL Portico server ... – remote control of networked IPCs

Page 455



Resy+ – function blocks for extending standard control and I/O components with remote control protocols

Page 485

Visualization



SafetyProg – programming software for INTERBUS-Safety systems and PROFIsafe controllers
Page 90



Functional and industry-specific software and drivers
Page 485



WebVisit – development software for web-based visualizations
Page 441



Visu+ – SCADA visualization, development and runtime licenses
Page 442



Diag+ NetScan – diagnostics software for cyclic INTERBUS diagnostics
Page 448



FL VIEW – network diagnostics software
Page 322



AIP – software for monitoring and alarm generation
Page 450

Drivers and interfaces



OPC UA – communication interface for PC Worx-programmed controllers
Page 452



AX OPC server – communication interface for PC Worx-programmed controllers
Page 453



FL SNMP OPC server – monitoring/configuration of SNMP-compatible devices in HMI and SCADA systems
Page 453

Marking



CLIP PROJECT – planning and marking software
• See Catalog 5 – marking and labeling section

System simulation



WinMOD AX ... – system software incl. INTERBUS/PROFINET IO simulation software
Info: www.winmod.com



IB Emulator – hardware required to simulate INTERBUS configurations with the WinMOD software
Order No. 2988638

Programming with PC Worx

PC Worx is the consistent engineering software for all controllers from Phoenix Contact. It combines programming according to IEC 61131, fieldbus configuration, and system diagnostics – in a single software solution. This provides optimum interaction between hardware and software.

The PC Worx engineering tool can be used in all areas of industry. From the outset the software has been developed and optimized as a uniform and user-friendly engineering environment for all controller classes.

The software includes all the programming languages defined in IEC 61131-3:

- Instruction List (IL)
- Function Block Diagram (FBD)
- Ladder Diagram (LD)
- Sequential Function Chart (SFC)
- Structured text (ST)

Efficient programming

The PC Worx interface can be customized to your individual requirements with clearly arranged workspaces and toolbars. The basic languages of IEC 61131 (LD, FBD, and IL) can be directly and freely cross compiled. Structured text can be converted into any of the three basic languages.

All editors use assistants, which support and monitor the addition of data types, function blocks, operators, and variable declarations for quicker and more user-friendly editing. For text editors, another assistant is available for keywords and their command structures.

Startup and maintenance

During controller operation, the following functions round off IEC 61131 programming:

- Cross-references for editing
- Online and offline program comparison by all IEC editors and configuration data
- Startup functions
- Debug functions such as:
 - Logic analysis in realtime
 - Breakpoints
 - Address debugging
 - Step-by-step mode
 - Overwriting and forcing of variables

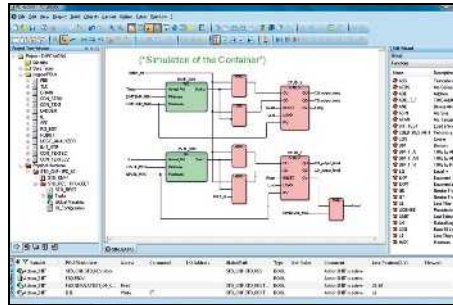

In order to test the program code, there is a powerful simulation tool for all INTEL®-compatible controllers. This shortens the startup times of the real system.

All data configured in PC Worx can be easily reused for visualization purposes via standard interfaces such as the AX OPC server or an integrated web server. The OPC and web server variables are selected by clicking with the mouse.

Worldwide use assured

You can switch between numerous languages in the interface. Program comments can be exported and imported for translation. You can therefore save projects together with their comments in various languages.

Integrated password handling supports various protection models, such as saving the project, protecting individual POUs (program organization units) against write or read access (expertise protection) or disabling actions such as controller start/stop.

I/O configuration

Network structures such as PROFINET, INTERBUS, PROFIBUS, and Modbus/TCP can be configured in PC Worx via an integrated bus configurator. A device catalog lists all components in clear groupings; the components can be applied in the hardware configuration using drag-and-drop.

In connection view, the program variables are connected to the inputs and outputs of the network components. The variables are addressed automatically.

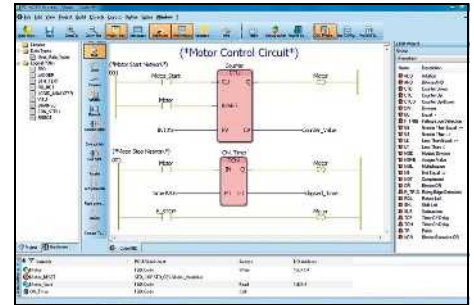

Diagnostics

The integrated Diag+ diagnostics tool is used to handle the diagnostics of all system components in the INTERBUS and PROFINET network. This tool enables precise error localization in the entire system.

Preventive diagnostic functions such as monitoring the transmission quality of fiber optic paths in INTERBUS systems increase system availability. Diagnostic data, causes of malfunctions, and solutions are displayed directly in plain text.

Programming environment for controller class 100

With PC Worx Express, Phoenix Contact provides a free engineering tool that can be used to easily program class 100, class 1000, and PC Worx SRT small-scale controllers. This is achieved, for example, thanks to an even clearer user interface.

PC Worx Express offers numerous proven functions such as project creation, fast application development, plus easy download, monitoring, and startup of the PLC program. Intelligent automated functions such as the automatic insertion of program instances in the task or simplified variable handling speed up programming.

PC Worx Express can be downloaded free of charge:

phoenixcontact.net/products

If the application requires the advanced functions of PC Worx, the project created with PC Worx Express can be opened with the standard programming environment in order to transfer the created data to PC Worx - as a result no data is lost.



Free programming environment for modular small-scale controllers



Software package for Phoenix Contact controllers programmed as per IEC 61131

	Technical data
Hardware requirements	
Processor	Pentium 4/Celeron 1.6 GHz, minimum
Main memory (RAM)	Min. 1 Gbyte (2 GB for Windows 7 and Windows 8)
Hard disk memory	Min. 2 Gbyte
Optical drive	DVD-ROM
Operating equipment	Keyboard, mouse
Monitor resolution	XGA (1024 x 768)
Software requirements	
Operating systems	MS Windows® 7 Professional (32 bit/64 bit), SP1 / MS Windows® 7 Ultimate (32-Bit/64-Bit), SP1 / MS Windows® 8 Professional (32-Bit/64-Bit) / MS Windows® 8 Ultimate (32-Bit/64-Bit) / MS Windows® 8.1 Professional (32-Bit/64-Bit) / MS Windows® 8.1 Ultimate (32-Bit/64-Bit)
Supported browsers	Internet Explorer Version 8 or later
Basic functions	Configuring an automation system, parameterizing INTERBUS devices, operating INTERBUS, programming an automation system according to IEC 61131-3, communication according to IEC 61131-5 IEC 61131 includes the following programming languages: - Function block diagram (FBD), - Ladder diagram (LD), - Structured text (ST) Network configuration (functionality of Config+) Network diagnostics (functionality of Diag+) - 128 kbytes of I/O data (mixed)
Languages supported	German, English, French, Italian, Spanish, Chinese

	Ordering data		
Description	Type	Order No.	Pcs. / Pkt.
Free programming version without license mechanism for class 100/1000 controllers and PC Worx SRT, 128 kbytes of I/O data	PC Worx EXPRESS	2988670	1
Demo software with Quick Start Guide , 16 byte input/output data, Diag+ limited to 5 devices			
Basic license with 2048 bytes of I/O data, without MSFC compiler			
Full license with 128 KByte input/output data, with MSFC compiler included			
Low-cost upgrade of existing basic license to a full license			

	Technical data
Hardware requirements	
Processor	Pentium 4/Celeron 1.6 GHz, minimum
Main memory (RAM)	Min. 1 Gbyte (2 GB for Windows 7 and Windows 8)
Hard disk memory	Min. 2 Gbyte
Optical drive	DVD-ROM
Operating equipment	Keyboard, mouse
Monitor resolution	XGA (1024 x 768)
Software requirements	
Operating systems	MS Windows® 7 Professional (32 bit/64 bit), SP1 / MS Windows® 7 Ultimate (32-Bit/64-Bit), SP1 / MS Windows® 8 Professional (32-Bit/64-Bit) / MS Windows® 8 Ultimate (32-Bit/64-Bit) / MS Windows® 8.1 Professional (32-Bit/64-Bit) / MS Windows® 8.1 Ultimate (32-Bit/64-Bit)
Supported browsers	Internet Explorer Version 8 or later
Basic functions	Planning an automation system, parameterizing the INTERBUS and PROFINET devices, operating INTERBUS and PROFINET, programming an automation system according to IEC 61131-3, communication according to IEC 61131-5 IEC 61131 includes the following programming languages: - Instruction list (IL), -Function block diagram (FBD), -Ladder diagram (LD), -Structured text (ST), -Symbolic flowchart (SFC) Add-on to IEC 61131: Fixed Format Ladder Editor (FFLD) and Machine Sequential Function Chart language MSFC (from the license PC Worx PRO LIC onwards) Network configuration (functionality of Config+) Network diagnostics (functionality of Diag+) 128 kbytes of I/O data (mixed) (full license)
Languages supported	German, English, French, Italian, Spanish, Chinese

	Ordering data		
Description	Type	Order No.	Pcs. / Pkt.
Free programming version without license mechanism for class 100/1000 controllers and PC Worx SRT, 128 kbytes of I/O data	PC Worx EXPRESS	2988670	1
Demo software with Quick Start Guide , 16 byte input/output data, Diag+ limited to 5 devices	PC Worx DEMO	2985725	1
Basic license with 2048 bytes of I/O data, without MSFC compiler	PC Worx BASIC LIC	2985275	1
Full license with 128 KByte input/output data, with MSFC compiler included	PC Worx PRO LIC	2985385	1
Low-cost upgrade of existing basic license to a full license	PC Worx BASIC-PRO LIC	2985259	1

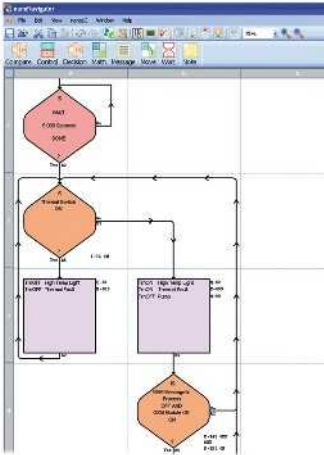

The **nanoNavigator** software is the ideal solution for all setup, programming, and maintenance tasks relating to the Nanoline programmable logic module and can be downloaded free of charge.

Connect your PC to the programmable logic module via one of the serial connections. It takes just four steps to create a control program with the software, which you can also start and stop from the PC. At the same time, you can monitor the progress of the program and data such as inputs, outputs, registers, flags or timers in online mode.

The programming languages offered by the software include flowchart and ladder diagram, which is used in electrical engineering in particular. In general, development tasks can be performed quickly with the nanoNavigator software, as you can also modify data elements and monitor their execution from the PC, and you also have the option of simulating the application.

nanoNavigator can be used intuitively and without detailed prior knowledge. Together with the Nanoline programmable logic module, the system represents a user-friendly and cost-effective solution for editing clear control tasks efficiently.



Software for programming and maintenance tasks relating to the Nanoline programmable logic module

Hardware requirements
Processor
Main memory (RAM)
Hard disk memory
Optical drive
Interfaces
Operating equipment
Monitor resolution
Software requirements
Operating systems
Basic functions
Languages supported

Technical data		
Pentium > 400 MHz		
512 Mbyte (1 GB for Windows Vista)		
128 Mbyte		
CD-ROM		
COM port or USB port		
Keyboard, mouse		
SVGA (800 x 600)		
Software requirements		
MS Windows 2000, Windows XP, Windows Vista (32- and 64-bit), Windows 7 (32- and 64-bit)		
Basic functions		
Programming with flowcharts		
Programming with ladder diagram		
Project configuration		
Project simulation		
Execution monitoring		
Languages supported		
German, English, French, Spanish, Italian		

Description
Programming software

Ordering data		
Type	Order No.	Pcs. / Pkt.
NLC-NAV-01	2701221	1

WebVisit

You can now also benefit from the advantages of web-based visualization when controlling your automation systems. Visualize your networks, devices or processes with **WebVisit** – the inexpensive engineering tool from Phoenix Contact. With intuitive operation and without programming effort, you can create graphical interfaces for clear and straightforward work.

All Phoenix Contact controllers offer an integrated web server which forwards control data. Use this data and design visualization pages for your system using WebVisit. The big advantage for you is that WebVisit is a graphical editor – i.e., you do not need any Java or HTML programming knowledge.

WebVisit visualization pages can be displayed in any standard browser and on all of our web panels with integrated runtime environment. When you use WebVisit you only pay for the engineering once and create any number of pages.



Development software for web-based visualizations

Hardware requirements

Processor
Main memory (RAM)

Hard disk memory
Optical drive
Operating equipment
Monitor resolution

Software requirements

Operating systems

Supported browsers

Basic functions

Expanded functionality

Languages supported

Description

Development software for web-based visualizations

WebVisit, development software for web-based visualisations, with alarming, trending, and language selection

WebVisit, free development software for up to three web-based visualization pages

Upgrade license for upgrading from WEBVISIT 6 BASIC to WEBVISIT 6 PRO

Technical data

Pentium 4/Celeron 1.6 GHz, minimum
Min. 1 Gbyte (2 GB for Windows Vista and Windows 7)

Min. 2 Gbyte
DVD-ROM
Keyboard, mouse
XGA (1024 x 768)

MS Windows 7 SP1, 8.0 and 8.1 Professional and Ultimate (32/64-bit)
Internet Explorer Version 8 or later

The user interface has a functional design and even the basic version offers numerous graphic basic elements and functions.

The variables needed for visualization are imported directly from PC Worx.

German, English, French

Ordering data

Type	Order No.	Pcs. / Pkt.
WEBVISIT 6 BASIC	2700948	1
WEBVISIT 6 PRO	2700949	1
WEBVISIT 6 EXPRESS	2700954	1

Accessories

WEBVISIT 6 BASIC-PRO	2700950	1
-----------------------------	----------------	---



System visualization on smartphones or tablets with the Visu+ mobile visualization app

Visu+ is the visualization software with SCADA functionality for computer-aided control and monitoring of technical processes. Visu+ is suitable for any application: from a compact HMI device to an industrial PC.

Your advantages:

- Operation and monitoring of systems and machines
- Thanks to the central monitoring of a system, previously used indicators such as switches or signaling devices can be eliminated
- Trending: e.g., for plotting curves with measured data
- Alarming: monitoring process values for permissible and impermissible states, and notification via modem or web link, plus SMS, voice, and fax messages
- Data logging: recording data in a database for later analysis or graphical representation
- User management: assignment and restriction of user rights
- Reporting: analysis of collected data and representation of data in the form of a report
- Optional web clients provide access to operational data via the Internet or Intranet

Visualization projects created with Visu+ can be used on all PCs with Windows operating systems as well as on Windows CE-based HMI devices from the TP and OT ranges. A runtime license is required for Windows 2000/XP/Vista.

Extend your system visualization to smartphones or tablets with the **Visu+ mobile** visualization app from Phoenix Contact. You can design flexible operating and monitoring concepts, as the Visu+ mobile app allows you to access your system at any time and from any location.

Integrate Visu+ mobile quickly and easily in existing touch panel or industrial PC visualization solutions. The Visu+ web server required for the app is already pre-installed in numerous devices from Phoenix Contact, such as touch panels. IPCs with Visu+ simply need to be extended with the web license option.

Your advantages:

- Familiar comfort: simply use conventional smartphones or tablets to perform operation and monitoring
- Conventional SCADA functions such as trend display or alarm handling now also available on mobile devices
- Easy installation via Google Play store or App store
- High-performance, scalable Visu+ web server: up to 100 clients can be operated simultaneously in its maximum configuration
- Convenient generation of HTML visualization pages for the Visu+ web server from the Visu+ development environment



Easy app installation via Google Play store or Apple app store



Visu+ mobile on a mobile terminal device via access point, with a touch panel and integrated web server

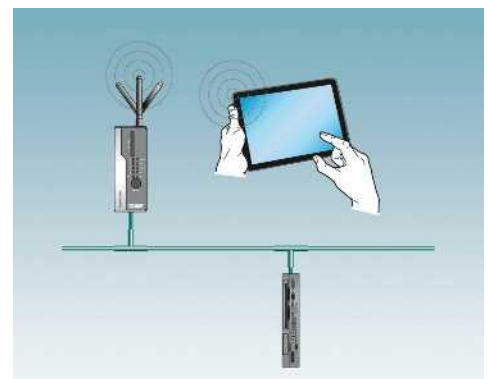

Visu+ mobile on a mobile terminal device via access point, with an industrial PC and web server as option



Notes:
Further licenses can be found on the Internet at phoenixcontact.net/products.

Development and runtime licenses for Visu+ (without drivers)

Runtime licenses for Visu+ with 2 direct drivers

	Technical data
Hardware requirements	
Processor	Pentium/Celeron, 1.6 GHz
Main memory (RAM)	Min. 1 Gbyte (2 GB for Windows Vista and Windows 7)
Hard disk memory	Min. 1 Gbyte (Recommended: 2 GB)
Optical drive	DVD-ROM
Operating equipment	Keyboard, mouse
Monitor resolution	XGA (1024 x 768)
Software requirements	
Operating systems	MS Windows XP SP3, MS Windows 2003 Server, MS Windows 2008 Server, MS Windows Vista Business SP2, MS Windows 7 Professional (32/64-bit) SP1, MS Windows 8 Professional (32/64-bit) - Version 2.31 or later
Supported browsers	Internet Explorer 5.5 or higher
Basic functions	Know-how protection and safety through coding of projects
	Realtime database coupling with ODBC to MS ACCESS, MS EXCEL and SQL server
	FDA CFR 21 Part 11 compatible
Options	Statistical alarm function Web client capability Redundancy function Advanced alarm management with SMS, FAX, e-mail and voice mail function Networking
Languages supported	German, English, French, Italian

	Technical data
Hardware requirements	
Processor	Pentium/Celeron, 1.6 GHz
Main memory (RAM)	Min. 1 Gbyte (2 GB for Windows Vista and Windows 7)
Hard disk memory	Min. 1 Gbyte (Recommended: 2 GB)
Optical drive	DVD-ROM
Operating equipment	Keyboard, mouse
Monitor resolution	XGA (1024 x 768)
Software requirements	
Operating systems	MS Windows XP SP3, MS Windows 2003 Server, MS Windows 2008 Server, MS Windows Vista Business SP2, MS Windows 7 Professional (32/64-bit) SP1, MS Windows 8 Professional (32/64-bit) - Version 2.31 or later
Supported browsers	Internet Explorer 5.5 or higher
Basic functions	Know-how protection and safety through coding of projects
	Realtime database coupling with ODBC to MS ACCESS, MS EXCEL and SQL server
	FDA CFR 21 Part 11 compatible
Options	Statistical alarm function Web client capability Redundancy function Advanced alarm management with SMS, FAX, e-mail and voice mail function Networking
Languages supported	German, English, French, Italian

	Ordering data		
Description	Type	Order No.	Pcs. / Pkt.
Development license for Visu+ projects	VISU+ 2	2988544	1
Runtime license for Visu+, where the I/O data and variables in scripting are limited	VISU+ 2 RT 64	2988683	1
- Limited to 64 bytes	VISU+ 2 RT 128	2988586	1
- Limited to 128 bytes	VISU+ 2 RT 256	2988609	1
- Limited to 256 bytes	VISU+ 2 RT 512	2988612	1
- Limited to 512 bytes	VISU+ 2 RT 1024	2988641	1
- Limited to 1024 bytes	VISU+ 2 RT 2048	2988528	1
- Limited to 2048 bytes	VISU+ 2 RT 4096	2988531	1
- Limited to 4096 bytes	VISU+ 2 RT 8192	2988557	1
- Limited to 8192 bytes	VISU+ 2 RT UNLIMITED	2988654	1
Runtime license for Visu+, without limitation for I/O data and variables in scripting			
Runtime license for Visu+, including networking function where the I/O data and variables in scripting are limited	VISU+ 2 RT 2048 NETWORKING	2701143	1
- Limited to 2048 bytes			

	Ordering data		
Description	Type	Order No.	Pcs. / Pkt.
Runtime license for Visu+ with 2 direct drivers	VISU+ 2 RT-D 64	2988751	1
	VISU+ 2 RT-D 128	2988696	1
	VISU+ 2 RT-D 256	2988719	1
	VISU+ 2 RT-D 512	2988722	1
	VISU+ 2 RT-D 1024	2988735	1
	VISU+ 2 RT-D 2048	2988764	1
	VISU+ 2 RT-D 4096	2988913	1
	VISU+ 2 RT-D 8192	2988573	1
	VISU+ 2 RT-D UNLIMITED	2988748	1
	VISU+2 RT-D 2048 NETWORK	2701670	1

atvise® SCADA



Software for visualization

Flexible operation and monitoring

atvise® SCADA is the new visualization software based on open web standards which can also be used to perform complex operation and monitoring tasks. Since the software uses web technology exclusively without any plug-ins, you can use your visualization on any device. You just need a web browser.

Your advantages:

- Visualization from any location and any device via a standard browser, without additional client or plug-in installation
- Flexible design with Scalable Vector Graphics (SVG), every resolution without any loss of quality
- Interfaces: OPC Classic, OPC UA
- Fast creation of even complex visualizations (SCADA) as no web or programming knowledge is required

Main features:

- Comprehensive object libraries for numerous industries and applications
- Design complex functions easily thanks to the full-fledged script editor for JavaScript programming
- Easy operation thanks to drag and drop
- Freely scalable: can be used on controllers (webMI) or PCs (SCADA)

Order No. / designation:

2400478 ATVISE

2400479 ATVISE UPD

2400480 ATVISE EXPANSION

Acron**Software for data management systems****The central node for data acquisition**

Acquire, archive, and analyze all operating and process data for your system with the **Acron** data management software. Based on this data you can create individual tables, graphics, and statistics quickly and easily.

Acron is the ideal software solution for water and wastewater treatment or the solar industry, for example.

Your advantages:

- Individual long-term archiving, thanks to powerful database technology
- Tailored reporting, thanks to flexible data analysis and evaluation
- Legal certainty, thanks to permanent reports
- Time savings, thanks to fast configuration and convenient logging

Main features:

- All-in-one solution: evaluation and analysis of historical data
- Maximum data security for data acquisition (three-level cache) and storage (redundancy)
- Permanent, plant-wide, cross-system
- Native connections to various control systems

Order No. / designation:

2400115 ACRON

2400116 ACRON UPD

2400117 ACRON EXPANSION

Config+ from Phoenix Contact is the ideal software solution for configuring INTERBUS networks.

The clear user interface allows you to assign addresses using drag-and-drop and to configure even complex topologies. In addition, the Ethernet devices used can also be mapped and diagnosed. For reliable troubleshooting in INTERBUS networks, the integrated Diag+ diagnostics tool can be used.

Numerous functions for efficient configuration

In Config+, you can use a wide range of functions to efficiently configure systems with INTERBUS networks.

- Reading and comparing real and planned topology
- Address assignment via drag-and-drop or completely automatic
- Parameterization of several master boards and controller boards in one project
- Configuration of subsystems, e.g., lower-level robot systems
- Assignment and calling of external operating tools for intelligent devices
- Use of various (e.g., user-defined) device catalogs
- Import and export of device catalogs
- IP address assignment via BootP server
- Non-proprietary device parameterization using the FDT (field device technology) concept
- Monitoring function for wiring checks
- Topology data transfer to the SAFETYPROG safe programming tool

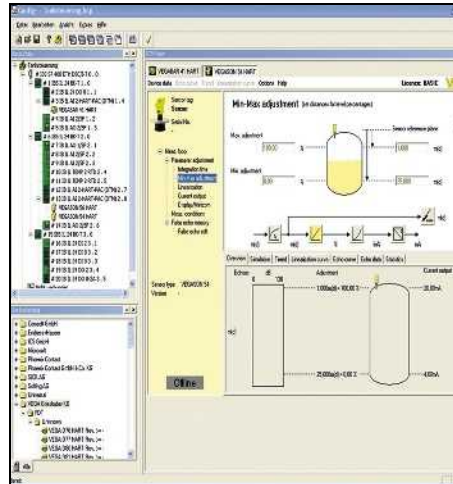

Comprehensive diagnostics for INTERBUS networks

Reliable diagnostics are essential for high system availability. INTERBUS networks can be diagnosed reliably with the Diag+ diagnostics tool integrated in Config+.

- Graphical display of error location in the network topology
- Output of plain text messages with tips for error removal
- Online display of device statuses
- Evaluation of statistical data for transmission quality
- Saving comments about error messages

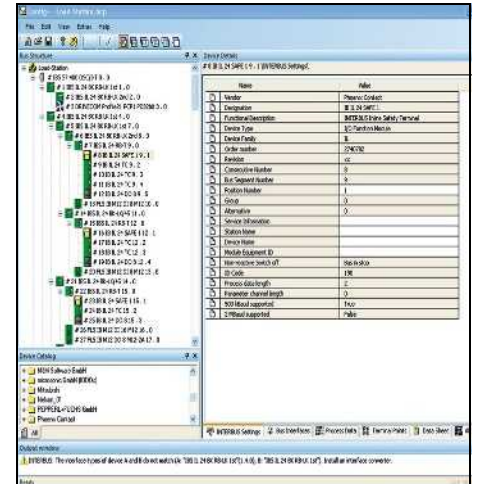

Integrated diagnostics for Ethernet devices

With Diag+, you can also view additional diagnostic information on the Ethernet devices used in the network.

- Receive traps by means of the integrated trap receiver
- Graphical display of the Ethernet topology (2D view) showing the availability of devices
- Display of port statistics, error information on the devices, as well as other properties that can be read via SNMP
- Calling of device web pages



Tool for fieldbus and network configuration

Technical data																															
Hardware requirements																															
Processor	Pentium 4/Celeron 1.6 GHz, minimum																														
Main memory (RAM)	Min. 1 Gbyte (2 GB for Windows Vista and Windows 7)																														
Hard disk memory	Min. 2 Gbyte																														
Optical drive	DVD-ROM																														
Interfaces	Serial interface, Ethernet, PCI																														
Operating equipment	Keyboard, mouse																														
Monitor resolution	XGA (1024 x 768)																														
Software requirements																															
Operating systems	MS Windows 7 SP1, 8.0 and 8.1 Professional and Ultimate (32/64-bit)																														
Supported browsers	Internet Explorer Version 8 or later																														
Termination boards supported	<table border="1"> <tbody> <tr><td>IBS S7 400 ETH SDSC/I-T</td><td>2819558</td></tr> <tr><td>IBS S7 400 ETH DSC/I-T</td><td>2731102</td></tr> <tr><td>IBS S7 400 DSC/I-T</td><td>2719962</td></tr> <tr><td>IBS S7 300 DSC-T</td><td>2719975</td></tr> <tr><td>IBS PCI SC/RI/I-T</td><td>2730080</td></tr> <tr><td>IBS PCI SC/RI-LK</td><td>2730187</td></tr> <tr><td>IBS PCI SC/I-T</td><td>2725260</td></tr> <tr><td>IBS PCI SC-LK</td><td>2700318</td></tr> <tr><td>FL IL 24 BK-B-PAC</td><td>2862327</td></tr> <tr><td>FL IL 24 BK-PAC</td><td>2862314</td></tr> <tr><td>FL NP PND-4TX IB</td><td>2985974</td></tr> <tr><td>FL NP PND-4TX IB-LK</td><td>2985929</td></tr> <tr><td>FLM BK ETH M12 DI 8 M12-2TX</td><td>2736916</td></tr> <tr><td>IL ETH BK DI8 DO4 2TX-PAC</td><td>2703981</td></tr> <tr><td>IBS USC4-2</td><td>2812209</td></tr> </tbody> </table>	IBS S7 400 ETH SDSC/I-T	2819558	IBS S7 400 ETH DSC/I-T	2731102	IBS S7 400 DSC/I-T	2719962	IBS S7 300 DSC-T	2719975	IBS PCI SC/RI/I-T	2730080	IBS PCI SC/RI-LK	2730187	IBS PCI SC/I-T	2725260	IBS PCI SC-LK	2700318	FL IL 24 BK-B-PAC	2862327	FL IL 24 BK-PAC	2862314	FL NP PND-4TX IB	2985974	FL NP PND-4TX IB-LK	2985929	FLM BK ETH M12 DI 8 M12-2TX	2736916	IL ETH BK DI8 DO4 2TX-PAC	2703981	IBS USC4-2	2812209
IBS S7 400 ETH SDSC/I-T	2819558																														
IBS S7 400 ETH DSC/I-T	2731102																														
IBS S7 400 DSC/I-T	2719962																														
IBS S7 300 DSC-T	2719975																														
IBS PCI SC/RI/I-T	2730080																														
IBS PCI SC/RI-LK	2730187																														
IBS PCI SC/I-T	2725260																														
IBS PCI SC-LK	2700318																														
FL IL 24 BK-B-PAC	2862327																														
FL IL 24 BK-PAC	2862314																														
FL NP PND-4TX IB	2985974																														
FL NP PND-4TX IB-LK	2985929																														
FLM BK ETH M12 DI 8 M12-2TX	2736916																														
IL ETH BK DI8 DO4 2TX-PAC	2703981																														
IBS USC4-2	2812209																														
Basic functions	<p>Project transfer to SafetyProg (software tool for programming INTERBUS Safety)</p> <p>Project planning of Ethernet configurations</p> <p>Planning of the address assignment</p> <p>Transfer of the address settings (address ranges, assignment list) from Step 7®</p> <p>Project planning of multimaster projects (several bus configurations in one project)</p> <p>Comparison between real and planned bus configuration</p> <p>Online display of device data sheets</p> <p>Comprehensive diagnostic functions, including optical diagnostics with Diag+</p> <p>Network diagnostics (functionality of Diag+)</p>																														
Languages supported	German, English, French, Italian, Spanish, Chinese																														
Ordering data																															
Description	<table border="1"> <thead> <tr> <th>Type</th> <th>Order No.</th> <th>Pcs. / Pkt.</th> </tr> </thead> <tbody> <tr> <td>Config+ demo version with restricted range of function (it is not possible to save projects)</td> <td>2868046</td> <td>1</td> </tr> <tr> <td>Config + full version for configuration and diagnosis of networks</td> <td>2868059</td> <td>1</td> </tr> </tbody> </table>	Type	Order No.	Pcs. / Pkt.	Config+ demo version with restricted range of function (it is not possible to save projects)	2868046	1	Config + full version for configuration and diagnosis of networks	2868059	1																					
Type	Order No.	Pcs. / Pkt.																													
Config+ demo version with restricted range of function (it is not possible to save projects)	2868046	1																													
Config + full version for configuration and diagnosis of networks	2868059	1																													
Accessories																															
Copy license , allows you to install the software multiple times. A full version is also required. Please specify the number of licenses required when ordering.	<table border="1"> <tbody> <tr> <td>CONFIG+ CPY</td> <td>2868062</td> <td>1</td> </tr> </tbody> </table>	CONFIG+ CPY	2868062	1																											
CONFIG+ CPY	2868062	1																													

Diag+

Diag+ – comprehensive diagnostics for PROFINET and INTERBUS networks

Diag+ is a special diagnostics software tool that has been adapted to PROFINET and INTERBUS and indicates both network errors and the current states of controllers and devices. Preventive diagnostic functions such as monitoring the transmission quality of fiber optic (FO) paths in PROFINET and INTERBUS increase system availability.

Wide range of functions for reliable diagnostics

Status information, operating functions, plain text messages, and overviews ensure fast startup, error localization, and easy orientation in PROFINET and INTERBUS systems.

- Start and stop of INTERBUS data traffic
- Acknowledgment of INTERBUS error messages
- Bridging, switch on, and switch off of INTERBUS devices
- Display of error messages with tips for error removal and detailed information on the device type and device state
- Display of color symbols for errors and device states
- Preventive diagnostics such as monitoring transmission quality in FO paths
- Comparison and evaluation of FO diagnostic data records at varying times
- Generation of acceptance reports as PDF files
- Integration in other software tools such as visualizations
- Display of stored messages from the message archive of the controller
- Overview for the topology of Ethernet/PROFINET devices in a 2D graphic
- Specification of the accessibility of Ethernet/PROFINET devices
- Use of the configuration data and comments created with Config+ or PC Worx during the configuration phase (e.g., equipment IDs, station names)
- Management of individual rights of use for various users

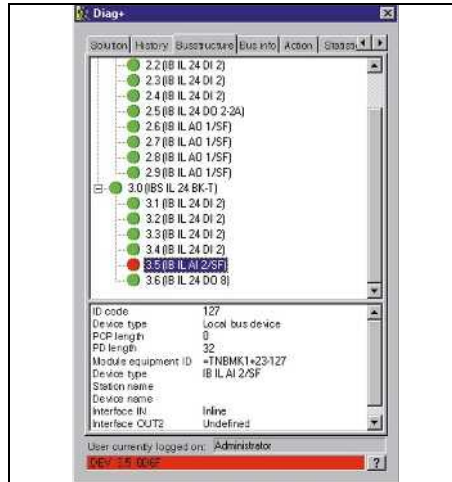

Diag+ NetScan – software for cyclic INTERBUS network diagnostics

Diag+ NetScan enables simultaneous monitoring of INTERBUS networks with several controller boards/controllers. The transmission quality of all FO paths in an entire system is thus monitored permanently. Even lower-level buses connected using system couplers can be included in monitoring.

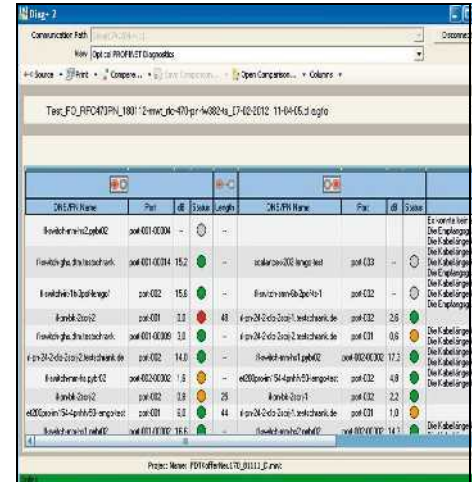

Ordering example 1:

The Diag+ software is to be used on ten different PCs of a system for PROFINET/INTERBUS network diagnostics.

Items required:

- 1x DIAG+
- 9x DIAG+ CPY

Ordering example 2:

Ethernet-networked INTERBUS controller boards (x 60) are to be monitored from a control room. In the event of an error, detailed diagnostic data should be displayed.

Items required:

- 1 x DIAG+ NETSCAN



Diagnostics software for INTERBUS, PROFINET and Ethernet networks



Diagnostics software for cyclic INTERBUS diagnostics

	Technical data	Technical data																		
Hardware requirements																				
Processor	Pentium 4/Celeron 1.6 GHz, minimum	Pentium 4/Celeron 1.6 GHz, minimum																		
Main memory (RAM)	min. 1 Gbyte (2 GB for Windows Vista and Windows 7)	min. 1 Gbyte (2 GB for Windows Vista and Windows 7)																		
Hard disk memory	min. 2 Gbyte	min. 2 Gbyte																		
Optical drive	DVD-ROM	DVD-ROM																		
Interfaces	Serial interface, Ethernet, PCI	Serial interface, Ethernet, PCI																		
Supported interface connections	INTERBUS generation 4 controller boards, PROFINET controller (Phoenix Contact only)	INTERBUS Generation 4 controller board																		
Software requirements																				
Operating systems	MS Windows 7 SP1, 8.0 and 8.1 Professional and Ultimate (32/64-bit)	MS Windows 7 SP1, 8.0 and 8.1 Professional and Ultimate (32/64-bit)																		
Basic functions	<p>Executing important commands (start/stop/...)</p> <p>Reading in the installed bus structure</p> <p>Detecting/representing error states (plain text from knowledge database)</p> <p>Saving diagnostics data in flash memory or parameterizing memory of the controller board</p> <p>Diagnostics of INTERBUS FO paths (transmission quality)</p> <p>Can be linked into other 32-bit applications as ActiveX Control including programming interface for further processing of all diagnostic data</p> <p>Reading out the Controller Diagnose Archive</p> <p>Numerous other diagnostic functions</p>	<p>Executing important commands (start/stop/...)</p> <p>Reading in the installed bus structure</p> <p>Detecting/representing error states (plain text from knowledge database)</p> <p>Saving diagnostics data in flash memory or parameterizing memory of the controller board</p> <p>Diagnostics of FO paths (transmission quality)</p> <p>Can be integrated into other 32-bit applications as ActiveX Control</p> <p>-</p> <p>-</p>																		
Expanded functionality	-	<p>Cyclical readout of diagnostic data from all INTERBUS controller boards/controllers in the network overview (the number of controller boards is not limited)</p> <p>Network overview: All INTERBUS controller boards/controllers in a system are clearly shown in a tree view; detailed diagnostics can be called up by clicking on the corresponding item</p> <p>Monitoring function: Simultaneous monitoring of up to 10 INTERBUS controller boards/controllers maximum</p>																		
Languages supported	German, English, French, Italian, Spanish, Chinese	German, English, French, Italian, Spanish, Chinese																		
	Ordering data	Ordering data																		
Description	<table border="1"> <thead> <tr> <th>Type</th> <th>Order No.</th> <th>Pcs. / Pkt.</th> </tr> </thead> <tbody> <tr> <td>DIAG+ DEMO</td> <td>2730734</td> <td>1</td> </tr> <tr> <td>DIAG+</td> <td>2730307</td> <td>1</td> </tr> </tbody> </table>	Type	Order No.	Pcs. / Pkt.	DIAG+ DEMO	2730734	1	DIAG+	2730307	1	<table border="1"> <thead> <tr> <th>Type</th> <th>Order No.</th> <th>Pcs. / Pkt.</th> </tr> </thead> <tbody> <tr> <td>DIAG+ NETSCAN DEMO</td> <td>2868091</td> <td>1</td> </tr> <tr> <td>DIAG+ NETSCAN</td> <td>2868075</td> <td>1</td> </tr> </tbody> </table>	Type	Order No.	Pcs. / Pkt.	DIAG+ NETSCAN DEMO	2868091	1	DIAG+ NETSCAN	2868075	1
Type	Order No.	Pcs. / Pkt.																		
DIAG+ DEMO	2730734	1																		
DIAG+	2730307	1																		
Type	Order No.	Pcs. / Pkt.																		
DIAG+ NETSCAN DEMO	2868091	1																		
DIAG+ NETSCAN	2868075	1																		
<p>DIAG+ demo, limited scope of functions (only valid for the first five stations)</p> <p>DIAG+ full version, for INTERBUS diagnostics (ActiveX Control with programming interface)</p> <p>DIAG+ NetScan-Demo, limited scope of functions (cannot open or save projects)</p> <p>DIAG+ NetScan full version, for cyclic and simultaneous network diagnostics (ActiveX Control)</p>																				
	Accessories	Accessories																		
<p>Copy license, allows you to install the software multiple times. A full version is also required. Please specify the number of licenses required when ordering.</p>	<table border="1"> <thead> <tr> <th>DIAG+ CPY</th> <th>2730404</th> <th>1</th> </tr> </thead> </table>	DIAG+ CPY	2730404	1	<table border="1"> <thead> <tr> <th>DIAG+ NETSCAN CPY</th> <th>2868088</th> <th>1</th> </tr> </thead> </table>	DIAG+ NETSCAN CPY	2868088	1												
DIAG+ CPY	2730404	1																		
DIAG+ NETSCAN CPY	2868088	1																		

AIP



Software for monitoring and alarm generation

Be kept informed of all system states at all times

The **AIP** software is a client/server user platform that supports modular expansion and allows you to aggregate and forward events from various data systems.

AIP is the ideal software if you want to implement a consistent alarm system, e.g., for wind or solar energy as well as infrastructure applications.

Your advantages:

- Be kept informed at all times by monitoring processes from any location
- Reduce costs by using on-call personnel effectively
- Increase system availability through quick and efficient intervention
- Secure system operation as only authenticated users have access to the system
- Unique audible signaling by the high-quality system-integrated text-to-speech engine

Main features:

- Interfaces: OPC Classic, OPC UA
- Native connection to the following control systems: WinCC/PCS7, iFIX, InTouch
- Analysis: historic event lists, top 10 alarms, alarm frequency, and detailed logging information
- Transmission media: SMS, voice output, e-mail, fax, VdS 2465, and reports

Order No. / designation:

2400485 AIP

2400486 AIP UPD

2400487 AIP EXPANSION

Startup+

Startup+ software is specifically tailored to the Axioline F I/O system. It can be used to test the wiring of I/O stations and parameterize the I/O modules used. Startup+ can be used to display and operate your Axioline F station during startup without having to connect the station to a higher-level network.

Startup+ offers many useful functions for all aspects of the Axioline F I/O system:

- Reading and writing input and output signals
- Comprehensive diagnostics during operation
- Convenient connection of software to an Axioline F I/O station via the fieldbus or service interface
- Support connecting to the Axioline F station by means of a wizard
- Software is open for connection to TCI interfaces – for DTM integration in engineering systems
- Download the full version free of charge at phoenixcontact.net/products

Hardware requirements

Processor
Main memory (RAM)
Hard disk memory
Interfaces
Operating equipment

Software requirements

Operating systems

Basic functions

Languages supported

Description

Startup+, for checking the wiring of Axioline F stations and parameterizing devices



Software for startup and parameterization of Axioline I/O stations

Technical data

Pentium/Celeron, 1.6 GHz
1 Gbyte
200 Mbyte
Ethernet Port
Keyboard, mouse

MS Windows XP SP3, MS Windows 7 (32 bit)

I/O check
Diagnostics
Offline/online parameterization
Can be called via TCI interface

German, English, French, Spanish, Italian

Ordering data

Type	Order No.	Pcs. / Pkt.
STARTUP+	2700636	1

OPC server

Implement data exchange quickly and reliably between the following devices using OPC servers:

- PC Worx-programmable controllers
- SNMP (Simple Network Management Protocol)-compatible devices

The standardized OPC DA (Data Access) and OPC UA (Unified Architecture) interfaces enable easy integration in OPC-compatible visualization and control systems. OPC DA basic technology will be replaced by OPC UA in the future.

The **PC WORX UA SERVER** supports the PLCopen profile for controllers according to the OPC UA standard. Variables, structures, and structure definitions of PC Worx-programmed controllers are provided in a common address area.

The **AX OPC SERVER** operates according to the OPC DA standard and is used for data exchange between control systems, quality management systems or HMI stations with PC Worx-based controllers.

The **SNMP OPC SERVER V3** gathers device and network information which can be read via SNMP. In this way, you can integrate your SNMP-compatible devices in OPC-based process control systems (SCADA) or in HMI systems.

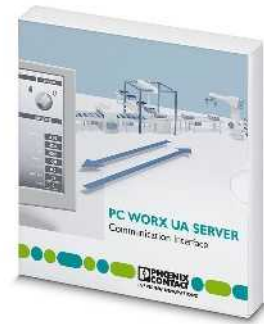

OPC UA - communication interface for PC Worx-programmed controllers

Hardware requirements	
Processor	Min. Intel® Atom™
Main memory (RAM)	Min. 2 Gbyte
Hard disk memory	-
Optical drive	DVD-ROM
Operating equipment	-
Supported interface connections	ILC 1xx, AXC 1xxx, AXC 3xxx, PC Worx RT BASIC/SRT

General requirements	
Operating systems	MS Windows® 7 (32-bit/64-bit) / MS Windows® 8 (32-bit/64-bit) / MS Windows® 8.1 (32-bit/64-bit)

Software requirements	
Basic functions	PC Worx Version 6 or later

Technical data

MS Windows® 7 (32-bit/64-bit) / MS Windows® 8 (32-bit/64-bit) / MS Windows® 8.1 (32-bit/64-bit)
PC Worx Version 6 or later
OPC UA server according to the OPC UA information model for IEC 61131-3
Easy access to arrays and structures
Good diagnostic properties
Secured remote configuration possible
Supported controllers, volume, and basic specifications depend on the license
-

Languages supported	
---------------------	--

German, English

Description	
OPC UA server for communication with a maximum of 10 modular small-scale controllers (AXC 1xxx or ILC 1xx)	
OPC UA server for communication with a maximum of 10 controllers	
OPC UA server for communication with a maximum of 200 controllers	
AX OPC SERVER , communication interface for OPC-compatible visualization with PC Worx-based controllers	
SNMP OPC server , for monitoring and configuring a maximum of 100 SNMP-compatible devices in HMI and SCADA systems	
Extension license , for 100 additional devices	

Ordering data

Type	Order No.	Pcs. / Pkt.
PC Worx UA SERVER-PLC10	2402684	1
PC Worx UA SERVER-PLC 40	2402685	1
PC Worx UA SERVER-PLC 80	2402686	1



OPC DA - communication interface for PC Worx-programmed controllers



Monitoring/configuration of SNMP-compatible devices in HMI and SCADA systems

Technical data
Pentium 4/Celeron 1.6 GHz, minimum Min. 1 Gbyte (2 GB for Windows Vista and Windows 7)
Min. 2 Gbyte DVD-ROM Keyboard, mouse ILC 1xx, AXC 1xxx, ILC 3xx, AXC 3xxx, RFC 4xx, PC Worx RT BASIC/SRT
MS Windows 7 SP1, 8.0 and 8.1 Professional and Ultimate (32/64-bit) PC Worx Version 3 or later
Supports OPC standard functions and all the optional interfaces (according to OPC spec. DA 1.0a and DA 2.04/2.05)
Simultaneous support to several controllers
Integrated OPC testing and diagnostics client
-
-

Technical data
PC Pentium > 266 MHz -
Min. 20 Mbyte CD-ROM Keyboard, mouse recommended Ethernet infrastructure components
Windows XP SP3, Windows Vista, Windows 7, Windows 2003 Server SP1, Windows 2008 Server / - / -
Monitoring and configuration of 100 SNMP-compatible devices in HMI/SCADA systems
Network monitoring with HMI/SCADA systems
SNMP Version v1 and v2c supported OPC clients OPC Data Access 1.0A/2.0 or OPC Alarm and Events supported Integrated MIB browser
Import/export and creation of device profiles supported, online and remote configuration possible via remote PCs

German, English

German, English

Ordering data		
Type	Order No.	Pcs. / Pkt.
AX OPC SERVER	2985945	1

Ordering data		
Type	Order No.	Pcs. / Pkt.
FL SNMP OPC SERVER V3	2701139	1
FL SNMP OPC SERVER V3 LIC 100	2701138	1

Project+

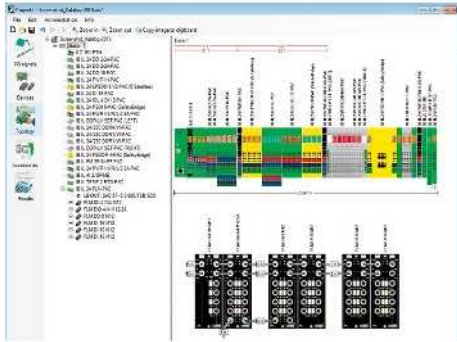

Project+ is a tool that provides support when planning and configuring an I/O station as part of the automation setup of a system, machine or property. With no training required, you can create a functional I/O station according to your specifications very quickly with Project+. The station provides functions for connecting sensors and actuators and corresponds to the technical configuration rules of the selected I/O system.

Workflow: enter the required I/O signals for connecting sensors and actuators in your application. Project+ then determines the optimum product selection from the Inline and Fieldline product ranges from Phoenix Contact - the selected devices are combined to create a station according to the configuration rules. You are immediately provided with a graphical structure plan and a parts list including item descriptions.

Thanks to various export functions, the configured I/O stations can be implemented directly for the subsequent engineering process.

Your advantages:

- Automated creation of the I/O station according to the technical configuration rules
- Representation of the configured I/O station as a graphical structure plan
- Extension of your automation setup using additional items from the Phoenix Contact product range
- Option of data export to CLIP PROJECT, PC Worx, Excel, and Word
- Full version can be downloaded for free phenixcontact.net/products



License-free software for planning Inline and Fieldline I/O stations

Hardware requirements
Processor
Main memory (RAM)
Hard disk memory
Optical drive
Operating equipment
Software requirements
Operating systems
Software requirements
Basic functions

Technical data	
Pentium/Celeron, 1.6 GHz	1 Gbyte (1 GB for Windows Vista)
Min. 300 Mbyte	DVD-ROM
Keyboard, mouse	
MS Windows® 8 (32 bit/64 bit) / MS Windows® 7 (32-bit/64-bit) / MS Windows® Vista Business / MS Windows® XP Professional (SP-4 recommended)	MS WORD 2003 or a higher version
Automated structure of the Inline and Fieldline I/O stations	
Consideration of technical configuration rules	
Automatic addition of accessories required by the system	
Graphical representation of the planned station structure as a structure plan	
Phoenix Contact complete catalog as accessories	
Project report via MS WORD	
Export functions for CLIP PROJECT and PC Worx	
Consideration of release lists	
German, English, Spanish, French, Italian, Dutch, Russian	

Languages supported

Description
Software for planning I/O stations

Ordering data		
Type	Order No.	Pcs. / Pkt.
PROJECT+	2988667	1

Portico

Optimally tailor your operating concept to the requirements of your system. With the Portico software, you can install up to 16 thin clients exactly where you need them. If multiple employees based in various locations need to access the machine, you can design individual solutions in this way.

Portico is a remote control software tool that allows you to view and fully interact with the desktop of another industrial PC over a network. The software uses a client/server architecture that either supports point-to-point connection between a server and client or allows communication to be established between a server and multiple clients. Thanks to the unique assignment of access rights, your system is also protected against unauthorized access.

Portico can also be used in a production environment to visualize or control a machine or process at a remote location in the system.

Your advantages:

- Individual operation and monitoring concepts with up to 16 clients
- Simultaneous display of IPC screen information at several operating stations without server operating system
- Inexpensive, thanks to the use of thin clients
- Configuration tool for user-friendly management of access rights
- Fast screen and input response, thanks to communication via TCP/IP network protocol
- Low memory usage by server and client

System requirements:

- CPU type/class: x86
- Minimum CPU clock rate: 1.0 GHz
- Minimum RAM: 512 MB
- Minimum memory required for server: 100 MB
- Minimum memory required for client: 100 MB
- LAN rate: 100 Mbps
- Graphics requirements: unlimited



Remote control software

Hardware requirements
Processor
Main memory (RAM)
Hard disk memory
Software requirements
Operating systems
Basic functions
Languages supported

Description
Remote control
- 1 client
- 4 clients
- 16 clients

Technical data	
Processor	Atom™ or above
Main memory (RAM)	≥ 512 Mbyte (minimum)
Hard disk memory	≥ 100 Mbyte (minimum (client and server))
Operating systems	Windows XP SP3 / Windows 7
Basic functions	Remote control software
Languages supported	German, English, French, Spanish, Italian

Ordering data		
Type	Order No.	Pcs. / Pkt.
VL PORTICO SERVER 1 CLIENT	2701453	1
VL PORTICO SERVER 4 CLIENT	2701455	1
VL PORTICO SERVER 16 CLIENT	2701456	1



Controllers

Suitable for all requirements

From distributed water supply to highly complex painting lines in the automotive industry – reliable and cost-effective automation with controllers from Phoenix Contact. The broad spectrum offers innovative control solutions from programmable logic modules to high-end controllers.

Programmable logic modules

Control and switch basic applications reliably – with programmable logic relay systems or standard logic modules.

Modular controllers

Class 100 and 300 programmable logic controllers impress with their modular structure and resulting flexibility. You can find the right control solution for small to complex tasks.

Axioccontrol controllers

Axioccontrol controllers are fast, robust, and user-friendly, i.e., they are all designed for maximum performance, easy handling, and use in harsh industrial environments.

Compact controllers

Automation at the highest level: the class 400 PLCs are high-performance high-end controllers for moderate to sophisticated tasks.

Software PLC

Two devices in one: utilize the available resources of your industrial PC and transform it into a powerful controller using the software PLC.

Product overview	458
<hr/>	
Controllers	
Programmable logic modules	460
Modular controllers	474
Axioccontrol controllers	480
Compact controllers controllers	482
Software PLC	484
Function blocks	485
Starter kits	487
<hr/>	
Services for automation	488

Controllers

Product overview

Programmable logic modules



Nanoline – basic, extension, and communication modules

Page 460



Programmable logic relay system
• See Catalog 7 – relay modules

Modular controllers



Class 100 modular small-scale controllers
Page 474



Class 200 modular small-scale controllers
• phoenixcontact.net/products

Compact controllers



Class 400 compact controllers

Page 482



RFC 430/450ETH-IB
• phoenixcontact.net/products



S-MAX 400 CE PN
• phoenixcontact.net/products



S-MAX 41x CE PN panel PC
• phoenixcontact.net/products

Software for control technology



Functional and industry-specific software and drivers

Page 485

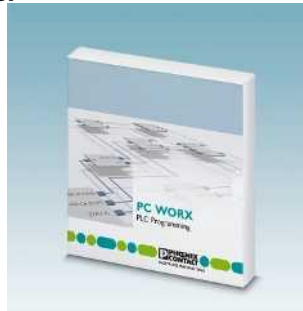

PC WOrX – software package for Phoenix Contact controllers programmed according to IEC 61131

Page 438



PC WOrX Express – free programming environment for class 100 modular small-scale controllers

Page 438



WebVisit – development software for web-based visualizations

Page 441

Easy Automation - system based on modular controllers



Easy Automation – class 100 modular small-scale controllers

Page 477



Easy Automation – ILC 131 starter kit

Page 487

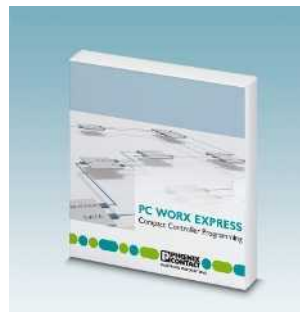

Easy Automation – software

Page 438



Easy Automation – memory cards

Page 485

Axiocontrol controllers



Class 300 modular controllers
Page 478



Class 1000 modular small-scale controllers
Page 480



Modular class 3000 high-performance controllers
Page 481

Software PLC



PC Worx RT BASIC – software PLC with realtime extension
Page 484

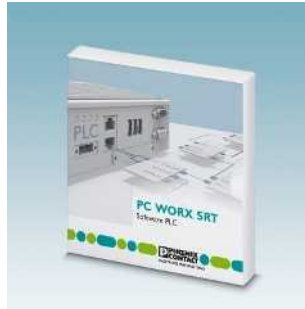

PC Worx SRT – software PLC without realtime extension
Page 484

Starter kits



PROFINET starter kit
Page 487



ILC 131 starter kit
Page 487

System cabling



• See Catalog 7 – system cabling for controllers

Services for automation



Services – hotline, on-site service, startup support, professional workshops
Page 488



Training – individual training concepts, training courses
Page 488



Engineering – configuration, programming, visualization, coaching
Page 488



Easy Automation – industrial network technology
Page 484



Easy Automation – I/O systems for the control cabinet (IP20)
Page 166



Easy Automation – I/O systems for field installation (IP65/67)
Page 224



Easy Automation – panels for operation and monitoring
Page 109

Controllers

Programmable logic modules

Nanoline logic module

Minimal effort with maximum benefits – for Nanoline programmable logic modules the focus is on simplicity and flexibility. This means a modular and adaptable design with optimum networking options. For tailored use, optionally connect a logic module to other modules: I/O extension module, communication module, operator panel, realtime clock.

Your advantages:

- Save time – by intelligently controlling basic tasks
- Easy use without prior knowledge, thanks to intuitive programming with flowcharts
- Versatile communication with numerous integration and networking options
- Maximum flexibility, thanks to the modular design

Additional features:

- Modules for different operating voltages, available in 24 V DC, 12 V DC or 110 ... 240 V AC
- Supports 4 mathematical functions and includes 2 high-speed counters and 2 analog inputs
- Integrated digital I/Os
- Add up to 3 additional digital and analog I/O extension modules for a maximum of 44 I/O points
- An operator panel can be optionally integrated in the logic module or installed remotely on a panel
- Integrated realtime clock (RTC)
- Optional USB, RS-232 or RS-485 modules for connection to a PC for configuration download
- Optional RS-232 and RS-485 allow you to use your logic module as a Modbus/RTU server
- Intuitive programming language with options for flowcharts and ladder diagrams.

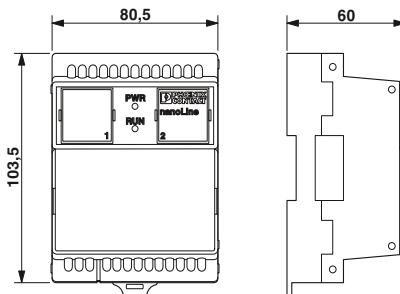

24 V DC, 8 digital inputs, 2 analog inputs and 4 relay outputs

ERC

Power supply	
Supply voltage	24 V DC (power available to the I/O and Communications modules)
Supply voltage range	19.2 V DC ... 30 V DC
Typical current consumption	150 mA
Max. current consumption	250 mA
Digital inputs	
Number of inputs	8
Description of the inputs	EN 61131-2 type 1 NPN/PNP
Typical response time	20 ms (on)
Digital outputs	
Number of outputs	4
Description of the outputs	Relay output
Maximum output current per channel	5 A
Maximum output current per module / terminal block	20 A
Protective circuit	External protection required
Analog input	
Number of inputs	2
Voltage input signal	0 V DC ... 10 V DC
Counter input	
Number of inputs	2
Input frequency	6 kHz
Software interfaces	
Programming tool	nanoNavigator 3 or above
Realtime clock	Yes (battery-backed)
Accuracy	±2 s/day @ 25°C ±4 s/day @ -20 °C ... +60 °C
General data	
Connection method	Screw connection
Weight	262 g
Degree of protection	IP20
Ambient temperature (operation)	-25 °C ... 60 °C

Technical data

Power supply	
Supply voltage	24 V DC (power available to the I/O and Communications modules)
Supply voltage range	19.2 V DC ... 30 V DC
Typical current consumption	150 mA
Max. current consumption	250 mA
Digital inputs	
Number of inputs	8
Description of the inputs	EN 61131-2 type 1 NPN/PNP
Typical response time	20 ms (on)
Digital outputs	
Number of outputs	4
Description of the outputs	Relay output
Maximum output current per channel	5 A
Maximum output current per module / terminal block	20 A
Protective circuit	External protection required
Analog input	
Number of inputs	2
Voltage input signal	0 V DC ... 10 V DC
Counter input	
Number of inputs	2
Input frequency	6 kHz
Software interfaces	
Programming tool	nanoNavigator 3 or above
Realtime clock	Yes (battery-backed)
Accuracy	±2 s/day @ 25°C ±4 s/day @ -20 °C ... +60 °C
General data	
Connection method	Screw connection
Weight	262 g
Degree of protection	IP20
Ambient temperature (operation)	-25 °C ... 60 °C

Description
Nanoline controller , requires nanoNavigator 3 or above
- 8 digital inputs, 2 analog inputs, 4 DC relay outputs
- 8 digital inputs, 2 analog inputs and 4 PNP digital outputs
- 8 digital inputs and 4 relay outputs

Ordering data

Type	Order No.	Pcs. / Pkt.
NLC-055-024D-08I-04QRD-05A	2700464	1

Cover , replacement
Operator panel
Cap , replacement
Slot 1
Cap , replacement
Slot 2

Accessories

Type	Order No.	Pcs. / Pkt.
NLC-OP1-COVER	2701276	1
NLC-MOD-CAP	2701289	1
NLC-MOD-CAP-PXC	2701292	1



12 V DC, 8 digital inputs,
2 analog inputs and 4 relay outputs



24 V DC, 8 digital inputs,
2 analog inputs and 4 PNP digital outputs



100...240 V AC, 8 digital inputs
and 4 relay outputs

ERC

ERC

ERC

Technical data

Technical data

Technical data

12 V DC (power available to the I/O and Communications modules)

9 V DC ... 15 V DC
250 mA
400 mA

8
EN 61131-2 type 1 NPN/PNP
20 ms (on)

4
Relay output
5 A
20 A
External protection required

2
0 V DC ... 10 V DC

2
6 kHz

nanoNavigator 3 or above
Yes (battery-backed)
±2 s/day @ 25°C
±4 s/day @ -20 °C ... +60 °C

Screw connection
248 g
IP20
-25 °C ... 60 °C

24 V DC (power available to the I/O and Communications modules)

19.2 V DC ... 30 V DC
100 mA
250 mA

8
EN 61131-2 type 1 NPN/PNP
60 µs (on)

4
PNP outputs
500 mA
2 A
Short-circuit and overload protection

2
0 V DC ... 10 V DC

2
6 kHz

nanoNavigator 3 or above
Yes (battery-backed)
±2 s/day @ 25°C
±4 s/day @ -20 °C ... +60 °C

Screw connection
178 g
IP20
-25 °C ... 60 °C

240 V AC (power available to the I/O and Communications modules)

-
50 mA (at 230 V AC)
70 mA (at 110 V AC)

8
EN 61131-2 type 1 NPN/PNP
20 ms (on)

4
Relay output
5 A
20 A
External protection required

-

-

-

nanoNavigator 3 or above
Yes (battery-backed)
±2 s/day @ 25°C
±4 s/day @ -20 °C ... +60 °C

Screw connection
150 g
IP20
-25 °C ... 60 °C

Ordering data

Ordering data

Ordering data

Type	Order No.	Pcs. / Pkt.
NLC-055-012D-081-04QRD-05A	2700486	1

Type	Order No.	Pcs. / Pkt.
NLC-055-024D-081-04QTP-00A	2700453	1

Type	Order No.	Pcs. / Pkt.
NLC-055-100A-081-04QRA-05A	2700487	1

Accessories

Accessories

Accessories

Accessories	Order No.	Pcs. / Pkt.
NLC-OP1-COVER	2701276	1
NLC-MOD-CAP	2701289	1
NLC-MOD-CAP-PXC	2701292	1

Accessories	Order No.	Pcs. / Pkt.
NLC-OP1-COVER	2701276	1
NLC-MOD-CAP	2701289	1
NLC-MOD-CAP-PXC	2701292	1

Accessories	Order No.	Pcs. / Pkt.
NLC-OP1-COVER	2701276	1
NLC-MOD-CAP	2701289	1
NLC-MOD-CAP-PXC	2701292	1

Controllers

Programmable logic modules

Nanoline logic module

Minimal effort with maximum benefits – for Nanoline programmable logic modules the focus is on simplicity and flexibility. This means a modular and adaptable design with optimum networking options. For tailored use, optionally connect a logic module to other modules: I/O extension module, communication module, operator panel, realtime clock.

Your advantages:

- Save time – by intelligently controlling basic tasks
- Easy use without prior knowledge, thanks to intuitive programming with flowcharts
- Versatile communication with numerous integration and networking options
- Maximum flexibility, thanks to the modular design

Additional features:

- Modules for different operating voltages, available in 24 V DC, 24 V AC/DC or 110 ... 240 V AC
- Integrated digital I/Os
- Add up to 3 additional digital and analog I/O extension modules for a maximum of 42 I/O points
- An operator panel can be optionally integrated in the logic module or installed remotely on a panel
- Integrated realtime clock (RTC)
- Optional USB, RS-232 or RS-485 modules for connection to a PC for configuration download
- Optional RS-232 and RS-485 allow you to use your logic module as a Modbus/RTU server
- Intuitive programming language with options for flowcharts and ladder diagrams.

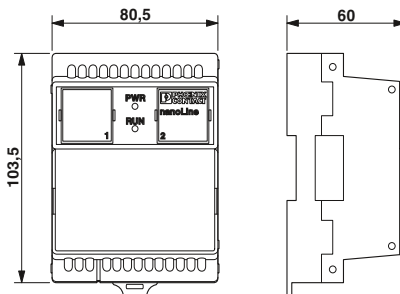

**24 V DC,
6 digital inputs and 4 NPN/PNP outputs**

Power supply	
Supply voltage	
Supply voltage range	19.2 V DC ... 30 V DC
Typical current consumption	92 mA
Max. current consumption	250 mA
Digital inputs	
Number of inputs	6
Description of the inputs	EN 61131-2 type 1 NPN/PNP
Typical response time	60 µs (on)
Digital outputs	
Number of outputs	4
Description of the outputs	NPN outputs PNP outputs
Maximum output current per channel	500 mA
Maximum output current per module / terminal block	2 A
Protective circuit	Short-circuit and overload protection
Software interfaces	
Programming tool	nanoNavigator 1 or 2
Realtime clock	Optional module
General data	
Connection method	Screw connection
Weight	240 g
Degree of protection	IP20
Ambient temperature (operation)	-25 °C ... 60 °C

Description	
Nanoline controller , requires nanoNavigator 1 or 2	
- 6 digital inputs, 4 NPN outputs	
- 6 digital inputs, 4 PNP outputs	
- 6 digital inputs, 4 DC relay outputs	
- 8 digital inputs, 4 AC/DC relay outputs	
- 8 digital inputs, 4 AC/DC relay outputs	

Cover , replacement	Operator panel
Cap , replacement	Slot 1
Cap , replacement	Slot 2



Technical data	
NLC-050-024D-061-04QTN-00A NLC-050-024D-061-04QTP-00A	
24 V DC (power available to the I/O and Communications modules)	
19.2 V DC ... 30 V DC	
92 mA	
250 mA	
6	
EN 61131-2 type 1 NPN/PNP	
60 µs (on)	
4	
NPN outputs	PNP outputs
500 mA	
2 A	
Short-circuit and overload protection	
nanoNavigator 1 or 2	
Optional module	
Screw connection	
240 g	
IP20	
-25 °C ... 60 °C	

Ordering data		
Type	Order No.	Pcs. / Pkt.
NLC-050-024D-061-04QTN-00A	2701030	1
NLC-050-024D-061-04QTP-00A	2701027	1

Accessories		
NLC-OP1-COVER	2701276	1
NLC-MOD-CAP	2701289	1
NLC-MOD-CAP-PXC	2701292	1



24 V DC,
6 digital inputs and 4 relay outputs



24 V AC/DC,
8 digital inputs and 4 relay outputs



100 - 240 V AC,
8 digital inputs and 4 relay outputs



Technical data
24 V DC (power available to the I/O and Communications modules)
19.2 V DC ... 30 V DC
150 mA
250 mA
6
EN 61131-2 type 1 NPN/PNP
60 µs (on)
4
Relay output
5 A
20 A
Short-circuit and overload protection
nanoNavigator 1 or 2
Optional module
Screw connection
260 g
IP20
-25 °C ... 60 °C

Technical data
24 V AC/DC (power available to the I/O and Communications modules)
19 V DC ... 30 V DC
150 mA (@ 24 V AC/DC)
250 mA
8
EN 61131-2 type 1 NPN/PNP
20 ms
4
Relay output
5 A
20 A
Short-circuit and overload protection
nanoNavigator 1 or 2
Optional module
Screw connection
248 g
IP20
-25 °C ... 60 °C

Technical data
100 V AC
240 V AC (power available to the I/O and Communications modules)
100 V AC ... 240 V AC
70 mA (@ 230 V AC)
-
8
EN 61131-2 type 1 NPN/PNP
20 ms
4
Relay output
5 A
20 A
Short-circuit and overload protection
nanoNavigator 1 or 2
Optional module
Screw connection
268 g
IP20
-25 °C ... 55 °C

Ordering data		
Type	Order No.	Pcs. / Pkt.
NLC-050-024D-06I-04QRD-05A	2701043	1

Ordering data		
Type	Order No.	Pcs. / Pkt.
NLC-050-024X-08I-04QRX-05A	2701056	1

Ordering data		
Type	Order No.	Pcs. / Pkt.
NLC-050-100A-08I-04QRA-05A	2701069	1

Accessories		
Type	Order No.	Pcs. / Pkt.
NLC-OP1-COVER	2701276	1
NLC-MOD-CAP	2701289	1
NLC-MOD-CAP-PXC	2701292	1

Accessories		
Type	Order No.	Pcs. / Pkt.
NLC-OP1-COVER	2701276	1
NLC-MOD-CAP	2701289	1
NLC-MOD-CAP-PXC	2701292	1

Accessories		
Type	Order No.	Pcs. / Pkt.
NLC-OP1-COVER	2701276	1
NLC-MOD-CAP	2701289	1
NLC-MOD-CAP-PXC	2701292	1

Controllers

Programmable logic modules

Nanoline logic module

Minimal effort with maximum benefits – for Nanoline programmable logic modules the focus is on simplicity and flexibility. This means a modular and adaptable design with optimum networking options.

Your advantages:

- Save time – by intelligently controlling basic tasks
- Easy use without prior knowledge, thanks to intuitive programming
- Versatile communication with numerous integration and networking options
- Maximum flexibility, thanks to the modular design

Additional features:

- Two high-speed counters and two analog inputs
- Supports four mathematical functions
- Integrated digital I/O
- Add an additional digital I/O extension module for a maximum of 12 I/O points
- Support for large Nanoline operator panel
- Integrated realtime clock (RTC)
- Integrated RS-232 for connection to a PC for programming and configuration
- Integrated RS-232 and RS-485 allow you to use your logic module as a Modbus RTU server

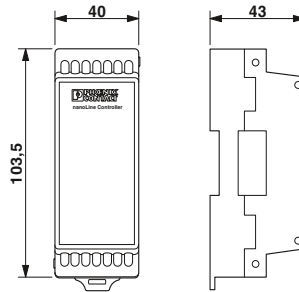

24 V DC, 4 digital inputs and 2 relay outputs

Technical data	
Power supply	
Supply voltage	24 V DC (power available to the I/O and Communications modules)
Supply voltage range	19.2 V DC ... 30 V DC
Typical current consumption	74 mA
Max. current consumption	81 mA
Digital inputs	
Number of inputs	4
Description of the inputs	PNP
Typical response time	10 µs (Channel 1 and 2)
Digital outputs	
Number of outputs	2
Description of the outputs	Relay output
Maximum output current per channel	5 A
Maximum output current per module / terminal block	10 A
Software interfaces	
Programming tool	nanoNavigator 4.2 or above
General data	
Connection method	Screw connection
Degree of protection	IP20
Ambient temperature (operation)	-25 °C ... 70 °C

Description
Nanoline controller - Programmable with nanoNavigator 4.2 and above
Programming cable - 9-pos. D-SUB to RJ11/12

Ordering data		
Type	Order No.	Pcs. / Pkt.
NLC-035-024D-04I-02QRD-05A	2702031	1
Accessories		
NLC-PC/SERIAL-CBL 2M	2701234	1

Digital I/O extension module for NLC-035 logic module

You can extend your Nanoline with an additional I/O extension module. Extension modules provide additional inputs and outputs beyond what is available on the logic module.

- The NLC-IOX is only compatible with the NLC-035
- One module can be added to the right side of a logic module
- Automatically recognized by nanoNavigator

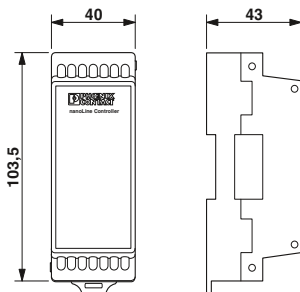

4 digital inputs and 2 relay outputs

Power supply for module electronics	
Supply voltage	24 V DC
Digital inputs	
Maximum number of inputs	4
Description of the inputs	PNP
Digital outputs	
Number of outputs	2
Description of the outputs	Relay output
Maximum output current per channel	5 A
Maximum output current per module / terminal block	10 A

Technical data

Power supply for module electronics		
Supply voltage	24 V DC	
Digital inputs		
Maximum number of inputs	4	
Description of the inputs	PNP	
Digital outputs		
Number of outputs	2	
Description of the outputs	Relay output	
Maximum output current per channel	5 A	
Maximum output current per module / terminal block	10 A	

Description	
Nanoline controllers, I/O extension module	
- 4 digital inputs, 2 relay outputs	

Ordering data

Type	Order No.	Pcs. / Pkt.
NLC-IOX-04I-02QRD-05A	2702032	1

Nanoline digital I/O extension module

Depending on the required I/Os, you can extend your Nanoline logic module with additional I/O extension modules. The combination of digital and analog I/Os may vary.

Digital I/O extension modules provide additional inputs and outputs beyond what is available on the logic module:

- Up to 3 modules can be added to the right side of a logic module
- Automatically recognized by nanoNavigator
- I/O modules are electrically isolated
- Can be powered from a secondary power supply

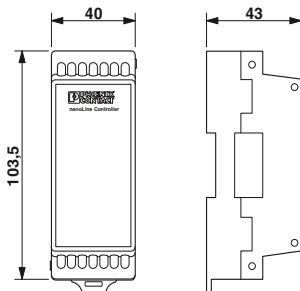

3/6 inputs, 4 PNP/NPN outputs

Power supply for module electronics	
Supply voltage	24 V DC
Digital inputs	
Maximum number of inputs	6
Description of the inputs	PNP/NPN
Digital outputs	
Maximum number of outputs	4
Description of the outputs	PNP outputs
Maximum output current per channel	500 mA
Maximum output current per module / terminal block	2 A

Technical data

Type	Order No.	Pcs. / Pkt.
NLC-IO-06I-04QTP-01A	2701072	1
NLC-IO-06I-04QTN-01A	2701085	1
NLC-IO-03I-04QRD-05A	2701328	1

Description	
Nanoline controllers, I/O extension module	
- 6 digital inputs, 4 PNP outputs	
- 6 digital inputs, 4 NPN outputs	
- 3 digital inputs, 4 DC relay outputs	

Ordering data

Type	Order No.	Pcs. / Pkt.
NLC-IO-06I-04QTP-01A	2701072	1
NLC-IO-06I-04QTN-01A	2701085	1
NLC-IO-03I-04QRD-05A	2701328	1

Controllers

Programmable logic modules

Nanoline analog I/O extension module

Analog I/O extension modules provide additional inputs and outputs beyond what is available on the logic module:

- A system may have up to 8 analog inputs and 8 analog outputs.
- Configuration options for 0 ... 10 V DC, ±10 V DC, 4 ... 20 mA, and 0 ... 20 mA inputs.
- Configuration options for 0 ... 10 V DC, 4 ... 20 mA, and 0 ... 20 mA outputs.
- Up to 3 modules can be added to the right side of a logic module
- Automatically recognized by nanoNavigator
- I/O modules are electrically isolated
- Can be powered from a secondary power supply

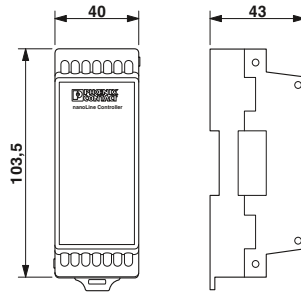

Analog I/O extension module

Power supply for module electronics	
Supply voltage	
Analog inputs	
Connection method	
Number of inputs	
Description of the input	
Accuracy	
Voltage input signal	
Current input signal	
Resolution A/D	
Limit frequency (3 dB)	
Analog outputs	
Connection method	
Number of outputs	
Accuracy	
D/A resolution	
Voltage output signal	
Load/output load voltage output	
Current output signal	
Load/output load current output	
General data	
Connection method	
Ambient temperature (operation)	
EMC note	

Description	
Nanoline controllers, I/O extension module	
2 analog inputs, 2 analog outputs	
4 analog inputs	



Technical data	
NLC-IO-2AI-2AO-01	NLC-IO-4AI
24 V DC	
Screw connection	
2 (voltage or current can be chosen separately)	4 (voltage or current can be chosen separately)
Single ended	
1 %	
0 V ... 10 V / -10 V ... 10 V	
0 mA ... 20 mA / 4 mA ... 20 mA	
12 bit	
5 Hz	
Screw connection	-
2	-
1 %	-
12 bit	-
0 V ... 10 V	-
1000 Ω	-
0 mA ... 20 mA / 4 mA ... 20 mA	-
500 Ω	-
Screw connection	
-25 °C ... 60 °C	
Class A product, see page 527	

Ordering data		
Type	Order No.	Pcs. / Pkt.
NLC-IO-2AI-2AO-01	2701040	1
NLC-IO-4AI	2701098	1

Nanoline analog I/O extension module

Temperature extension module provides RTD and thermocouple inputs as well as four digital outputs.

- Two temperature sensor inputs
- Configuration options for Pt 100 and Pt 1000 RTD sensors with two or three wires
- Configuration options for thermocouple types B, E, J, K, N, R, S, and T
- Four PNP digital outputs
- Automatically recognized by nanoNavigator

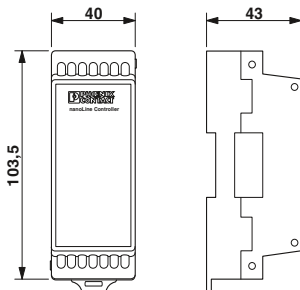

2 temperature inputs, 4 PNP outputs

Power supply for module electronics	
Supply voltage	24 V
Temperature input	
Connection method	2 or 3-wire (shielded)
Number of inputs	2
Sensor types (RTD) that can be used	Pt 100, Pt 1000
Sensor types that can be used (TC)	B, E, J, K, N, R, S, T
Digital outputs	
Number of outputs	4
Description of the outputs	PNP outputs
Nominal output voltage	24 V DC
Maximum output current per channel	0.5 A
Maximum output current per module / terminal block	2 A
Maximum switching voltage	24 V DC
Minimum switching voltage	0.8 V DC
General data	
Connection method	Screw connection
Ambient temperature (operation)	0 °C ... 60 °C

Technical data

Supply voltage	24 V
Connection method	2 or 3-wire (shielded)
Number of inputs	2
Sensor types (RTD) that can be used	Pt 100, Pt 1000
Sensor types that can be used (TC)	B, E, J, K, N, R, S, T
Number of outputs	4
Description of the outputs	PNP outputs
Nominal output voltage	24 V DC
Maximum output current per channel	0.5 A
Maximum output current per module / terminal block	2 A
Maximum switching voltage	24 V DC
Minimum switching voltage	0.8 V DC
Connection method	Screw connection
Ambient temperature (operation)	0 °C ... 60 °C

Description	
Nanoline controllers, I/O extension module	
- 2 temperature inputs, 4 PNP outputs	

Ordering data

Type	Order No.	Pcs. / Pkt.
NLC-IO-2RTD/UTH-4QTP-01A	2701671	1

Controllers

Programmable logic modules

Nanoline Ethernet communication extension module

The Ethernet extension module enables optimum integration of Nanoline in your network. In combination with the Ethernet extension module, you can also use your Nanoline logic module as a Modbus/TCP server.

You can therefore read and write I/O points, registers, timers, counters, and program and system flags – independently of the program and from any location.

- Read only or read/write access control
- Watchdog timer monitors communication, providing either a warning or fault

Note: One of the serial connection option modules is required to configure and program the Nanoline controller.

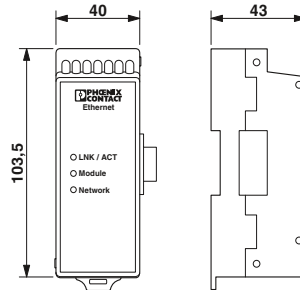

10/100 Mbps, Modbus TCP server

Interface	Ethernet 10/100Base T
Interface	RJ45
Connection method	10/100 Mbps (auto negotiation)
Transmission speed	100 m
Transmission length	LNK/ACT; Module; Network
Signal LEDs	
Power supply for module electronics	24 V DC (power available via logic module)
Supply voltage	110 mA
Typical current consumption	

Technical data

Type	Order No.	Pcs. / Pkt.
NLC-COM-ENET-MB1	2701124	1

Ordering data

Description	Nanoline controllers , communication module Ethernet module for Modbus® TCP Server functionality
-------------	--

Type	Order No.	Pcs. / Pkt.
NLC-COM-ENET-MB1	2701124	1

Nanoline communication extension module

The GSM module provides remote access to the Nanoline controller through SMS messaging:

- Allows access to read and write registers, flags, timers and counters
- Switch outputs on and off
- Read inputs
- Sends system faults and warning messages
- Password protected to allow selective access or broadcast to an onboard address book

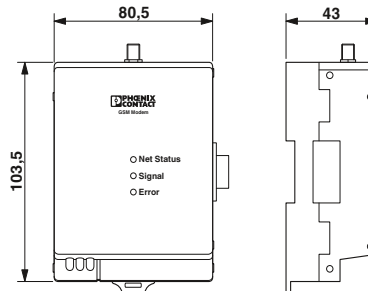

GSM communication

Wireless interface	GSM-SMS
Wireless standard	850/900/1800/1900 MHz
Frequency band	SMA (socket)
Antenna connection method	12 V DC ... 24 V DC (9.6 ... 28.8 V DC)
Power supply for module electronics	
Supply voltage range	
General data	R&TTE, FCC, AT&T, PTCRB
Wireless licenses	

Technical data

Type	Order No.	Pcs. / Pkt.
NLC-COM-GSM	2701344	1

Ordering data

Description	GSM communication extension module
-------------	---

Type	Order No.	Pcs. / Pkt.
NLC-COM-GSM	2701344	1

Accessories

Multi-band antenna for UMTS and quad band GSM, with omnidirectional characteristics	2313371	1
---	---------	---

PSI-GSM/UMTS-QB-ANT	2313371	1
---------------------	---------	---

Serial Nanoline RS-232/RS-485 and USB connection modules

With its serial communication modules, the Nanoline system sets new standards in connectivity. This results in easy integration and distributed monitoring and control.

Read and write I/O points, registers, timers, counters, and program and system flags – with the RS-232 module, you can use your Nanoline logic module as a Modbus/RTU server.

- Password control can limit access (read only or read/write)
- Watchdog timer monitors communication, providing either a warning or fault

Note: One of the serial connection option modules is required to configure and program the Nanoline controller.

Use the RS-232 or USB module to connect the logic module to your PC. From here you can carry out configuration with the nanoNavigator software.



Serial connection for data transmission or software configuration

Connection data	
Connection method	Installs in slot 1 of logic module
Power supply for module electronics	
Supply voltage	24 V DC (power available via logic module)
Typical current consumption	10 mA
Max. current consumption	18 mA
General data	
Ambient temperature (operation)	-25 °C ... 60 °C

Description	
Serial connection module , for data transfer	
RS-232 layer, USB Type B connector	
RS-232 layer, RJ11 connector	
RS-485 layer, RJ11 connector	

Serial cable, USB Type A to Type B	
Programming cable	
RS-485 cable , RJ11 to open cable end	



Technical data

Connection data	
Installs in slot 1 of logic module	
Power supply for module electronics	
24 V DC (power available via logic module)	
10 mA	
18 mA	
General data	
-25 °C ... 60 °C	

Ordering data

Type	Order No.	Pcs. / Pkt.
NLC-MOD-USB	2701195	1
NLC-MOD-RS232	2701179	1
NLC-MOD-RS485	2701182	1

Accessories

NLC-PC/USB-CBL 2M	2701247	1
NLC-PC/SERIAL-CBL 2M	2701234	1
NLC-RS485-CBL-5M	2701073	1

Programmable logic modules

Large operator panel

The operator panel is your interface for interacting with the Nanoline system. Read the status of all I/O points, registers, timers, counters, and program and system flags directly. In addition, the application program sends prompts and instructions to the display. The operator panel offers numerical (0-9), directional (up, down, left, right), and input keys. In addition, each of the 14 keys on the operator panel can be used to create user-specific menus in a flow chart.

Additional features:

- 76 mm diagonal screen
- Variable text sizes for enhanced readability of custom messages (4 x 20 or 2 x 10 or a combination)
- Cable length of up to 15 m allows remote mounting away from the logic module
- External 24 V DC
- Variable backlight: red, blue or green
- Adjustable backlight timer to save energy



User interface for Nanoline controllers

Display data	
Display	Backlit LC display, monochrome, 4 lines with 20 characters or 2 lines with 10 characters
Interfaces	
Operator panel	9-pos. D-SUB pin
Transmission length	Max. 15 m
Power supply for module electronics	
Supply voltage	24 V DC
Connection method	3-pos. COMBICON
Typical current consumption	38 mA (24 V DC)
Max. current consumption	40 mA (24 V DC)
General data	
Programming tool	nanoNavigator
Mounting type	Panel mounting
Keys	17
Height	102 mm
Width	128 mm
Depth	44.5 mm
Degree of protection	IP66
Ambient temperature (operation)	0 °C ... 50 °C
Ambient temperature (storage/transport)	0 °C ... 60 °C

Technical data

Backlit LC display, monochrome, 4 lines with 20 characters or 2 lines with 10 characters		
9-pos. D-SUB pin		
Max. 15 m		
24 V DC		
3-pos. COMBICON		
38 mA (24 V DC)		
40 mA (24 V DC)		
nanoNavigator		
Panel mounting		
17		
102 mm		
128 mm		
44.5 mm		
IP66		
0 °C ... 50 °C		
0 °C ... 60 °C		

Description	
Operator panel	

Ordering data

Type	Order No.	Pcs. / Pkt.
NLC-OP2-LCD-076-4X20	2701945	1

Base module for remote mounting operator panel (included in nLC-OP1-MKT)	
D-SUB plug , with two cable entries, universal type , pin assignment 1,2,3,4,5,6,7,8,9 on every screw terminal block	

Accessories

NLC-OP1-MKT-BASE	2701250	1
SUBCON-PLUS-M/AX 9	2904467	1

Nanoline operator panel

The operator panel is your interface for interacting with the Nanoline system. Read the status of all I/O points, registers, timers, counters, and program and system flags directly. In addition, the application program sends prompts and instructions to the display.

Unique feature: the operator panel offers numerical (0 - 9), direction (up, down, left, right), and input keys. In addition, each of the 14 keys on the operator panel can be used to create user-specific menus in a flowchart.

Additional features:

- The operator panel can be integrated in the logic module or installed remotely on a panel (1 m distance)
- The hot-swappable design enables use as a service tool
- Variable text sizes for enhanced readability of custom messages (4 x 20 or 2 x 10 or a combination)



User interface for Nanoline controllers

Display data	Display
Interfaces	Operator panel Transmission length
Power supply for module electronics	Supply voltage Connection method Typical current consumption Max. current consumption
General data	Programming tool Mounting type
Keys	11
Height	46 mm
Width	76 mm
Depth	31.5 mm
Degree of protection	IP67/IP20
Ambient temperature (operation)	0 °C ... 50 °C
Ambient temperature (storage/transport)	0 °C ... 60 °C
EMC note	Class A product, see page 527



Technical data	
Backlit LC display, monochrome, 4 lines with 20 characters or 2 lines with 10 characters	
RJ45	Max. 1 m
Power available via logic module	
RJ45	32 mA
	50 mA
nanoNavigator	
In logic module or with remote mounting kit	

Description
Operator panel
Remote mounting kit, for Operator Panel
Base module for remote mounting operator panel (included in nLC-OP1-MKT)
Bracket for remote mounting operator panel (included in nLC-OP1-MKT)
Cable, RJ45 to RJ45

Ordering data		
Type	Order No.	Pcs. / Pkt.
NLC-OP1-LCD-032-4X20	2701137	1

Accessories		
Type	Order No.	Pcs. / Pkt.
NLC-OP1-MKT	2701140	1
NLC-OP1-MKT-BASE	2701250	1
NLC-OP1-MKT-BRACKET	2701263	1
NLC-OP1-MKT-CBL	2701438	1

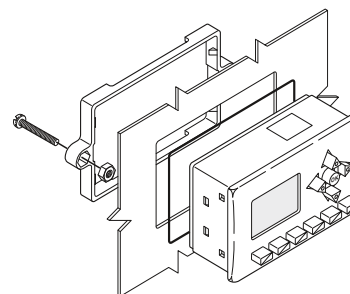
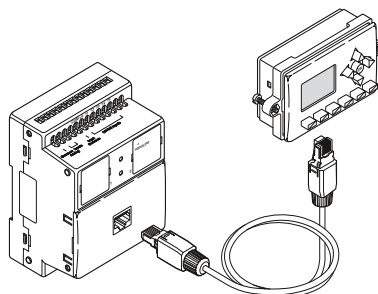

Controllers

Programmable logic modules

Nanoline realtime clock

For applications that require time or date functions, you can extend your Nanoline logic module with a realtime clock.

Configuration is via the nanoNavigator software or operator panel. In this way, you can integrate numerous functions into your Nanoline system:

- Optional on NLC-050... logic modules, standard on NLC-055... logic modules
- Compare time and date information in flowcharts
- Calculate even and odd days
- Adjust the time and date with other time components in the system

The realtime clock supports the following date formats:

- North American (month-day-year)
- European (day-month-year)
- International (year-month-day)



Realtime clock for Nanoline controllers

Power supply	
Supply voltage	24 V DC (power available via logic module)
Typical current consumption	4 mA
Max. current consumption	10 mA
Realtime clock	
Realtime clock	Yes (battery-backed)
Accuracy	2 s/day at 25 °C 4.5 s/day overall (60°C)
Battery	Life 5 years
General data	
Ambient temperature (operation)	-25 °C ... 60 °C

Technical data		
Power supply		
Supply voltage	24 V DC (power available via logic module)	
Typical current consumption	4 mA	
Max. current consumption	10 mA	
Realtime clock		
Realtime clock	Yes (battery-backed)	
Accuracy	2 s/day at 25 °C 4.5 s/day overall (60°C)	
Battery	Life 5 years	
General data		
Ambient temperature (operation)	-25 °C ... 60 °C	

Description
Realtime clock

Ordering data		
Type	Order No.	Pcs. / Pkt.
NLC-MOD-RTC	2701153	1

Nanoline memory module

Use the memory module to transmit projects:

- From a PC to one or more Nanoline controllers without a direct connection
- From one controller to another without a direct connection
- From a controller to a replacement controller



Memory module for Nanoline controllers

Power supply	
Supply voltage	Power available via logic module
Typical current consumption	15 mA
Max. current consumption	20 mA
General data	
Ambient temperature (operation)	-25 °C ... 60 °C

Technical data		
Power supply		
Supply voltage	Power available via logic module	
Typical current consumption	15 mA	
Max. current consumption	20 mA	
General data		
Ambient temperature (operation)	-25 °C ... 60 °C	

Description
Memory module, for data transfer

Ordering data		
Type	Order No.	Pcs. / Pkt.
NLC-MOD-MEM 032K	2701166	1

Nanoline starter kits

The Nanoline starter kit provides everything needed to get started with the Nanoline controller:

- Logic module
- Operator panel
- Input simulator (24 V AC or 24 V DC versions available)
- Output simulator (24 V AC or 24 V DC versions available)
- Serial USB module
- USB cable
- Quick start guide



Nanoline Starter Kit

Description	Ordering data		
	Type	Order No.	Pcs. / Pkt.
<p>Starter kit, consisting of: Base unit, operator panel, USB serial module and USB cable, input and output simulators</p> <p>- Logic module (2701030 NLC-050-024D-06I-04QTN-00A) with 6 digital inputs and 4 NPN digital outputs</p> <p>- Logic module (2701027 NLC-050-024D-06I-04QTP-00A) with 6 digital inputs and 4 PNP digital outputs</p> <p>- Logic module (2700464 NLC-055-024D-08I-04QRD-05A) with 8 digital inputs, 2 analog inputs, and 4 relay outputs</p>	NLC-START-01	2701399	1
	NLC-START-02	2701425	1
	NLC-START-03	2701467	1
<p>Deluxe starter kit, consisting of: Logic module (2700453 NLC-055-024D-08I-04QTP-00A) with 8 digital inputs, 2 analog inputs and 4 PNP digital outputs, operator panel, USB serial module and USB cable, input and output simulators, PNP digital expansion, I/O module, Ethernet module, STEP POWER power supply</p>	NLC-START-04	2701483	1

Controllers

Modular controllers

Class 100 controllers

Class 100 programmable logic controllers impress with their high function density at low prices. They support all common communication paths, such as Ethernet, mobile phone or fixed-line network.

The controllers can be easily extended with Inline I/O modules and offer an integrated web server. As the interface between the control center and I/O level, they efficiently control the data flow of your system. In short, they are ideal for small to medium-sized applications, even in distributed systems.

Your advantages:

- Maximum flexibility - numerous I/Os and special function modules can be mounted side by side
- Cost-effective solution, thanks to the excellent price/performance ratio with high function density
- Optimum communication - with integrated, freely programmable web server for visualization with the WebVisit software
- Versatile use, as all common IT protocols are supported

Additional features:

- PROFINET device function
- Modbus/TCP is integrated in the firmware - this increases performance and simplifies configuration. This makes communication with other Modbus devices even easier.
- SD card slot: for quick memory expansion and easy enabling of software blocks
- FTP server
- Flash file system
- Complete fieldbus master (4096 I/O points)
- Numerous protocols supported such as: HTTP, FTP, SNTP, SNMP, SMTP, SQL, MySQL, etc.
- Intuitive programming using PC Worx or using the free PC Worx Express software
- The XC versions are also suitable for increased temperature requirements (-40°C to +60°C)

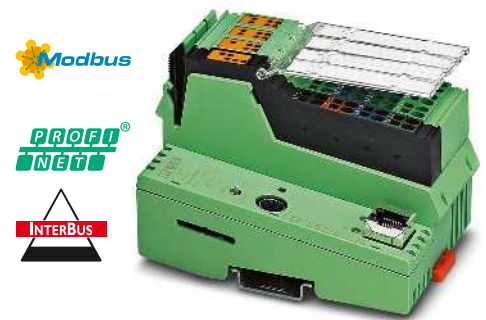

Small-scale controller – basic device



Interfaces	
INTERBUS local bus (master)	
Ethernet	
Parameterization/operation/diagnostics	
INTERBUS master	
Number of devices with parameter channel	
Number of supported devices	
Amount of process data	
Direct I/Os	
Number of inputs	
Number of outputs	
IEC-61131 runtime system	
Programming tool	
Processing speed	
Program memory	
Mass storage	
Retentive mass storage	
Number of data blocks	
Number of timers, counters	
Number of control tasks	
Realtime clock	
Power supply	
Supply voltage	
Supply voltage range	
Typical current consumption	
General data	
Dimensions	W / H / D
Degree of protection	
Ambient temperature (operation)	
EMC note	

Technical data	
ILC 131 ETH	ILC 131 ETH/XC
Inline data jumper	
RJ45 socket	
RS-232-C, 6-pos. MINI-DIN socket (PS/2), Ethernet 10/100 (RJ45)	
Max. 8	
Max. 63	
Max. 2048 Bit (INTERBUS)	
Max. 8192 Bit (internal Modbus Client)	
8	
4	
PC Worx / PC Worx Express	
1.7 ms (1 K mix instructions)	
90 µs (1 K bit instructions)	
192 kbyte (16 K instructions (IL))	
192 kbyte	
8 kbyte (NVRAM)	
depends on mass storage	
depends on mass storage	
8	
Yes	
24 V DC	
19.2 V DC ... 30 V DC	
210 mA	
80 mm / 119.8 mm / 71.5 mm	
IP20	
-25 °C ... 55 °C	
-40 °C ... 60 °C	
Class A product, see page 527	

Description
Small-scale controller , complete with accessories (connector plug and marking field)
- with extended temperature range

Ordering data		
Type	Order No.	Pcs. / Pkt.
ILC 131 ETH	2700973	1
ILC 131 ETH/XC	2701034	1

Parameterization memory , replaceable
- 256 MB
- 2 GB
- 512 MB
- 2 GB
- 512 MB
Programming cable

Accessories		
	Order No.	Pcs. / Pkt.
SD FLASH 2GB	2988162	1
SD FLASH 512MB	2988146	1
SD FLASH 2GB APPLIC A	2701190	1
SD FLASH 512MB APPLIC A	2701799	1
COM CAB MINI DIN	2400127	1

AX OPC SERVER , communication interface for OPC-compatible visualization with PC Worx- based controllers

AX OPC SERVER	2985945	1
----------------------	---------	---

Function modules

See page 485



Small-scale controller with remote bus support



Small-scale controller with two Ethernet ports



High-performance small-scale controller with integrated floating-point arithmetic

Ex:

Ex:

Ex:

Technical data	
ILC 151 ETH	ILC 151 ETH/XC
Inline data jumper RJ45 socket RS-232-C, 6-pos. MINI-DIN socket (PS/2), Ethernet 10/100 (RJ45)	
Max. 16 Max. 128 Max. 4096 Bit (INTERBUS) Max. 16384 Bit (internal Modbus Client)	
8 4	
PC Worx / PC Worx Express 1.5 ms (1 K mix instructions) 90 µs (1 K bit instructions) 256 kbyte (21 K instructions (IL)) 256 kbyte 8 kbyte (NVRAM) Depends on mass storage Depends on mass storage 8 Yes	
24 V DC 19.2 V DC ... 30 V DC 210 mA	
80 mm / 119.8 mm / 71.5 mm IP20 -25 °C ... 55 °C -40 °C ... 60 °C Class A product, see page 527	

Technical data	
Inline data jumper RJ45 socket RS-232-C, 6-pos. MINI-DIN socket (PS/2), Ethernet 10/100 (RJ45)	
Max. 24 Max. 128 Max. 4096 Bit (INTERBUS) Max. 32768 Bit (internal Modbus Client)	
8 4	
PC Worx / PC Worx Express 1.5 ms (1 K mix instructions) 90 µs (1 K bit instructions) 512 kbyte (43 K instructions (IL)) 512 kbyte 48 kbyte (NVRAM) Depends on mass storage Depends on mass storage 8 Yes	
24 V DC 19.2 V DC ... 30 V DC 210 mA	
80 mm / 119.8 mm / 71.5 mm IP20 -25 °C ... 55 °C Class A product, see page 527	

Technical data	
Inline data jumper RJ45 socket RS-232-C, 6-pos. MINI-DIN socket (PS/2), Ethernet 10/100 (RJ45)	
Max. 24 Max. 128 Max. 4096 Bit (INTERBUS) Max. 32768 Bit (internal Modbus Client)	
8 4	
PC Worx / PC Worx Express 1.3 ms (1 K mix instructions) 90 µs (1 K bit instructions) 1 Mbyte (86 K instructions (IL)) 1 Mbyte 48 kbyte (NVRAM) Depends on mass storage Depends on mass storage 8 Yes	
24 V DC 19.2 V DC ... 30 V DC 210 mA	
80 mm / 119.8 mm / 71.5 mm IP20 -25 °C ... 55 °C Class A product, see page 527	

Ordering data		
Type	Order No.	Pcs. / Pkt.
ILC 151 ETH	2700974	1
ILC 151 ETH/XC	2701141	1

Ordering data		
Type	Order No.	Pcs. / Pkt.
ILC 171 ETH 2TX	2700975	1

Ordering data		
Type	Order No.	Pcs. / Pkt.
ILC 191 ETH 2TX	2700976	1

Accessories		
SD FLASH 2GB	2988162	1
SD FLASH 512MB	2988146	1
SD FLASH 2GB APPLIC A	2701190	1
SD FLASH 512MB APPLIC A	2701799	1
COM CAB MINI DIN	2400127	1
AX OPC SERVER	2985945	1

See page 485

Accessories		
SD FLASH 256MB	2988120	1
SD FLASH 2GB	2988162	1
SD FLASH 512MB	2988146	1
SD FLASH 2GB APPLIC A	2701190	1
SD FLASH 512MB APPLIC A	2701799	1
COM CAB MINI DIN	2400127	1
AX OPC SERVER	2985945	1

See page 485

Accessories		
SD FLASH 256MB	2988120	1
SD FLASH 2GB	2988162	1
SD FLASH 512MB	2988146	1
SD FLASH 2GB APPLIC A	2701190	1
SD FLASH 512MB APPLIC A	2701799	1
COM CAB MINI DIN	2400127	1
AX OPC SERVER	2985945	1

See page 485

Controllers

Modular controllers

Class 100 controllers with integrated modem

These modular small-scale controllers offer all the functions of our 1x1 controllers.

In addition, they have an integrated mobile phone modem and more memory. This makes them the ideal solution for remote control and remote maintenance. The corresponding remote control software is: Resy+.

Additional features:

- Integrated GSM/GPRS modem, 16 digital inputs, 4 digital outputs
- Modbus/TCP is integrated in the firmware - this increases performance and simplifies configuration. This makes communication with other Modbus devices even easier.
- SD card slot: for quick memory expansion and easy enabling of software blocks
- FTP server
- Flash file system
- Complete fieldbus master (4096 I/O points)
- Numerous protocols supported such as: HTTP, FTP, SNMP, SMTP, SQL, MySQL, etc.
- Intuitive programming using PC Worx or using the free PC Worx Express software
- The XC versions are also suitable for increased temperature requirements (-40°C to +60°C)



Small-scale controller with integrated GSM/GPRS modem



Interfaces	
INTERBUS local bus (master)	
Ethernet	
-	
INTERBUS master	
Number of devices with parameter channel	
Number of supported devices	
Amount of process data	
Direct I/Os	
Number of inputs	16
Number of outputs	4
IEC-61131 runtime system	
Programming tool	PC Worx / PC Worx Express
Processing speed	1.5 ms (1 K mix instructions) 90 µs (1 K bit instructions)
Program memory	
Mass storage	512 kbyte (43 K instructions (IL))
Retentive mass storage	512 kbyte
Number of data blocks	48 kbyte (NVRAM)
Number of timers, counters	Depends on mass storage
Number of control tasks	Depends on mass storage
Realtime clock	8
Power supply	
Supply voltage	24 V DC
Supply voltage range	19.2 V DC ... 30 V DC
Typical current consumption	210 mA
General data	
Dimensions	W / H / D 85 mm / 119.8 mm / 71.5 mm
Degree of protection	IP20
Ambient temperature (operation)	-25 °C ... 55 °C
EMC note	Class A product, see page 527

Technical data		
Inline data jumper		
RJ45 socket		
-		
Max. 16		
Max. 128		
Max. 4096 Bit (INTERBUS)		
16		
4		
PC Worx / PC Worx Express		
1.5 ms (1 K mix instructions)		
90 µs (1 K bit instructions)		
512 kbyte (43 K instructions (IL))		
512 kbyte		
48 kbyte (NVRAM)		
Depends on mass storage		
Depends on mass storage		
8		
Yes		
24 V DC		
19.2 V DC ... 30 V DC		
210 mA		
85 mm / 119.8 mm / 71.5 mm		
IP20		
-25 °C ... 55 °C		
Class A product, see page 527		

Description
Small-scale controller , complete with accessories (connector plug and marking field)
Multi-band antenna for UMTS and quad band GSM, with omnidirectional characteristics
Parameterization memory , flash card without license
- 2 GB
- 512 MB
- 2 GB
- 512 MB
Programming cable
AX OPC SERVER , communication interface for OPC-compatible visualization with PC Worx-based controllers
Function modules

Ordering data		
Type	Order No.	Pcs. / Pkt.
ILC 151 GSM/GPRS	2700977	1

Accessories		
Type	Order No.	Pcs. / Pkt.
PSI-GSM/UMTS-QB-ANT	2313371	1
SD FLASH 2GB	2988162	1
SD FLASH 512MB	2988146	1
SD FLASH 2GB APPLIC A	2701190	1
SD FLASH 512MB APPLIC A	2701799	1
COM CAB MINI DIN	2400127	1
AX OPC SERVER	2985945	1
See page 485		

Class 100 controllers for machine building

The ME versions of the modular small-scale controllers have been specifically developed for the requirements of machine building. For example, for addressing drives via step motor drivers or frequency inverters.

The compact controllers offer all the functions of the ILC 1x1 and come with pre-installed functions for machine building. This means that various drive types can be controlled and sensors can be connected without any additional external modules.

Depending on the version, analog or incremental input channels can be used for position detection.

With Modbus/RTU and Easy Motion function block libraries, you can use the RS-485 and pulse/direction interface for positioning on simple 1-axis applications. The function block libraries are available to download free of charge.

Additional features:

- PWM/pulse/direction interface, RS-485

ILC 191 ME/INC:

- Fast counters
- Incremental encoders

ILC 191 ME/AN:

- 2 analog inputs
- 2 analog outputs

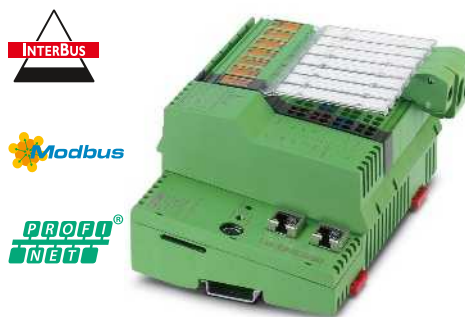

**Small-scale controller
For easy drive control**



Interfaces	
INTERBUS local bus (master)	
Ethernet	
Parameterization/operation/diagnostics	
INTERBUS master	
Number of devices with parameter channel	
Number of supported devices	
Amount of process data	
Direct I/Os	
Number of inputs	
Number of outputs	
Analog inputs/outputs	
Number of inputs	2
Number of outputs	2
Counter inputs	
Number of inputs	-
Input frequency	200 kHz
IEC-61131 runtime system	
Programming tool	PC Worx / PC Worx Express
Processing speed	1.3 ms (1 K mix instructions) 90 µs (1 K bit instructions)
Program memory	1 Mbyte (86 K instructions (IL))
Mass storage	1 Mbyte
Retentive mass storage	48 kbyte (NVRAM)
Number of data blocks	Depends on mass storage
Number of timers, counters	Depends on mass storage
Number of control tasks	8
Realtime clock	Yes
Power supply	
Supply voltage	24 V DC
Supply voltage range	19.2 V DC ... 30 V DC
Typical current consumption	310 mA 350 mA
General data	
Dimensions	W / H / D 164 mm / 136.8 mm / 71.5 mm
Degree of protection	IP20
Ambient temperature (operation)	-25 °C ... 55 °C
EMC note	Class A product, see page 527

Technical data	
ILC 191 ME/AN	ILC 191 ME/INC
	Inline data jumper RJ45 socket
	RS-232-C, 6-pos. MINI-DIN socket (PS/2), Ethernet 10/100 (RJ45)
	Max. 24 Max. 128 Max. 4096 Bit (INTERBUS) Max. 32768 Bit (internal Modbus Client)
	8 4
	- -
	- 2
	- 200 kHz
	PC Worx / PC Worx Express 1.3 ms (1 K mix instructions) 90 µs (1 K bit instructions) 1 Mbyte (86 K instructions (IL)) 1 Mbyte 48 kbyte (NVRAM) Depends on mass storage Depends on mass storage 8 Yes
	24 V DC 19.2 V DC ... 30 V DC
	310 mA 350 mA
	164 mm / 136.8 mm / 71.5 mm IP20 -25 °C ... 55 °C
	Class A product, see page 527

Description
Small-scale controller , complete with accessories (connector plug and marking field)
- Analog inputs/outputs
- Counter inputs

Ordering data		
Type	Order No.	Pcs. / Pkt.
ILC 191 ME/AN	2700074	1
ILC 191 ME/INC	2700075	1

Parameterization memory, flash card without license
- 2 GB
- 512 MB
- 2 GB
- 512 MB
Programming cable
AX OPC SERVER , communication interface for OPC-compatible visualization with PC Worx-based controllers

Accessories		
SD FLASH 2GB	2988162	1
SD FLASH 512MB	2988146	1
SD FLASH 2GB APPLIC A	2701190	1
SD FLASH 512MB APPLIC A	2701799	1
COM CAB MINI DIN	2400127	1
AX OPC SERVER	2985945	1

Controllers

Modular controllers

Class 300 controllers

The class 300 modular controllers can be used in complex applications where a high level of performance is required.

Thanks to consistent PROFINET connection and expansion with Inline I/O modules, the controllers are particularly flexible.

Your advantages:

- Highly flexible, thanks to expansion with numerous I/O modules
- Communication in realtime via PROFINET
- Optimum connection, with integrated web server and support for all common IT standards

Additional features:

- Integrated Ethernet interface
- Integrated web server for visualization with WebVisit
- FTP server
- Flash file system
- Numerous protocols supported such as: HTTP, FTP, SNMP, SMTP, SQL, MySQL, etc.
- Complete fieldbus master (8192 I/O points)
- Integrated PROFINET controller and integrated PROFINET device
- Engineering with PC Worx (IEC 61131-3)



Modular controller with larger memory capacity



Ex:

Interfaces	
INTERBUS (master)	
Higher-level INTERBUS (Slave)	
Ethernet	
Parameterization/programming/diagnostics	
INTERBUS master	
Number of devices with parameter channel	
Number of supported devices	
Amount of process data	
Direct I/Os	
Number of inputs	
Description of the input	
Number of outputs	
IEC-61131 runtime system	
Processing speed	
Program memory	
Mass storage	
Retentive mass storage	
Number of data blocks	
Number of timers, counters	
Number of control tasks	
Realtime clock	
Power supply	
Supply voltage	
Supply voltage range	
Typical current consumption	
General data	
Dimensions	W / H / D
Degree of protection	
Ambient temperature (operation)	
EMC note	

Technical data

Inline data jumper	
-	
RJ45 socket	
RS-232-C, 6-pos. MINI-DIN socket (PS/2), Ethernet 10/100 (RJ45)	
Max. 62	
Max. 512 (in total, of which 254 are remote bus devices/bus segments)	
Max. 8192 Bit (INTERBUS)	
12	
Eight fast inputs, interrupt input	
4	
0.5 ms (1 K mix instructions)	
9 μs (1 K bit instructions)	
Typ. 1 Mbyte (85 K instructions (IL))	
2 Mbyte	
64 kbytekbyte (NVRAM)	
Depends on mass storage	
Depends on mass storage	
16	
Integrated (battery backup)	
24 V DC ±5 %	
20.4 V DC ... 30 V DC	
250 mA (no local bus device connected during idling, bus inactive)	

Description	
Inline controller, complete with accessories (connector plug and marking field) and PROFINET I/O controllers	
- PROFINET controller	

Ordering data

Type	Order No.	Pcs. / Pkt.
ILC 350 PN	2876928	1

Parameterization memory	
- 256 MB	
- 2 GB	
Programming cable	
AX OPC SERVER, communication interface for OPC-compatible visualization with PC Worx-based controllers	

Accessories

	Order No.	Pcs. / Pkt.
CF FLASH 256MB	2988780	1
CF FLASH 2GB	2701185	1
COM CAB MINI DIN	2400127	1
AX OPC SERVER	2985945	1



Maximum performance modular controller with INTERBUS slave interface



Technical data

Inline data jumper
 D-SUB-9 socket/D-SUB-9 pin
 RJ45 socket
 RS-232-C, 6-pos. MINI-DIN socket (PS/2), Ethernet 10/100 (RJ45)

Max. 62
 Max. 512 (in total, of which 254 are remote bus devices/bus segments)
 Max. 8192 bit (INTERBUS master)
 Max. 512 bit (INTERBUS slave)

12
 Eight fast inputs, interrupt input
 4

0.2 ms (1 K mix instructions)
 6 µs (1 K bit instructions)
 Typ. 2 Mbyte (170 K instructions (IL))
 4 Mbyte
 96 kbyte (NVRAM)
 Depends on mass storage
 Depends on mass storage
 16
 Integrated (battery backup)

24 V DC ±5 %
 20.4 V DC ... 30 V DC
 250 mA (no local bus device connected during idling, bus inactive)

182 mm / 140.5 mm / 71.5 mm
 IP20
 -25 °C ... 55 °C
 Class A product, see page 527

Ordering data

Type	Order No.	Pcs. / Pkt.
ILC 390 PN 2TX-IB	2985314	1

Accessories

CF FLASH 256MB	2988780	1
CF FLASH 2GB	2701185	1
COM CAB MINI DIN	2400127	1
AX OPC SERVER	2985945	1

Controllers

Modular controllers

Axioccontrol controllers

The AXC 1050 Axioccontrol controllers are fast, robust, and user-friendly, i.e., they are all designed for maximum performance, easy handling, and use in harsh industrial environments.

Together with the Axioline I/O systems they form a high-performance, flexible, and particularly resistant automation system for every requirement.

Thanks to the integrated UPS, you can respond promptly to any voltage failures. Push-in connection technology simplifies wiring noticeably and also saves time.

Your advantages:

- Maximum flexibility - numerous I/Os and special function modules can be mounted side by side
- Cost-effective solution, thanks to the excellent price/performance ratio with high function density
- Optimum communication - with integrated, freely programmable web server for visualization with the WebVisit (HTML5, Java) or atvise® software
- Versatile use, as all common IT protocols are supported

Additional features:

- Continuous shock-resistant up to 10g
- Increased EMC robustness
- Micro USB interface: for fast startup or changing the PLC settings without knowing the IP address
- Modbus/TCP is integrated in the firmware - this increases performance and simplifies configuration. This makes communication with other Modbus devices even easier.
- SD card slot: for quick memory expansion and easy enabling of software blocks
- FTP server
- Flash file system
- Complete Axiobus master
- Integration of IT standards: FTP, HTTP, HTTPS, SNMP, SMTP, SQL, ODP, OPC, and many more
- Intuitive programming using PC Worx or using the free PC Worx Express software (IEC 61131-3)
- The XC versions are also suitable for increased temperature requirements (-40°C to +70°C)

Interfaces	
Axioline F local bus	
Ethernet	
Parameterization/operation/diagnostics	
AXIOBUS master	
Number of supported devices	
IEC-61131 runtime system	
Programming tool	
Processing speed	
Program memory	
Mass storage	
Retentive mass storage	
Number of data blocks	
Number of timers, counters	
Number of control tasks	
Realtime clock	
Power supply	
Supply voltage	
Supply voltage range	
Typical current consumption	
General data	
Dimensions	W / H / D
Degree of protection	
Ambient temperature (operation)	

EMC note

Description
Axioccontrol , complete with accessories (connector plug and marking field)
- with extended temperature range

Parameterization memory, flash card without license
- 2 GB
- 512 MB
- 2 GB
- 512 MB
Programming cable

Function modules

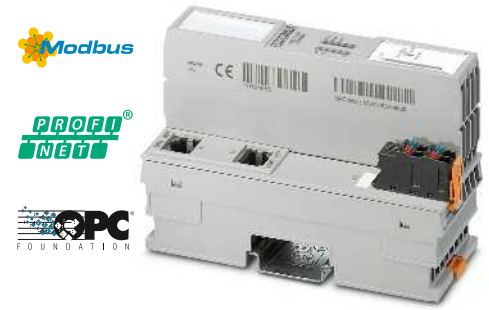

Small-scale controller

ClassNK
Ex: Ex

Technical data	
AXC 1050	AXC 1050 XC
	Bus base module RJ45 socket Micro USB type B
	Max. 63
	PC Worx / PC Worx Express 1.3 ms (1 K mix instructions) 90 µs (1 K bit instructions) 1 Mbyte (86 K instructions (IL)) 2 Mbyte 48 kbyte (NVRAM) Depends on mass storage Depends on mass storage 8 Yes
	24 V DC 19.2 V DC ... 30 V DC 125 mA
	45 mm / 125.9 mm / 74 mm IP20 -25 °C ... 60 °C -40 °C ... 70 °C (Observe derating as per user manual)

Class A product, see page 527

Ordering data		
Type	Order No.	Pcs. / Pkt.
AXC 1050	2700988	1
AXC 1050 XC	2701295	1

Accessories		
	Order No.	Pcs. / Pkt.
SD FLASH 2GB	2988162	1
SD FLASH 512MB	2988146	1
SD FLASH 2GB APPLIC A	2701190	1
SD FLASH 512MB APPLIC A	2701799	1
CAB-USB A/MICRO USB B/2,0M	2701626	1

See page 485

Axioccontrol controllers

The AXC 3050 is the high-end controller in the Axioccontrol range. It offers all the EMC, shock, and vibration properties of the AXC 1050, as well as push-in connection technology and intelligent functions for sophisticated automation.

Thanks to the powerful processor and technology functions such as fast counters and event tasks, you can even implement complex applications reliably and efficiently.

Your advantages:

- Highly flexible, thanks to expansion with numerous I/O modules
- Communication in realtime via PROFINET
- Optimum connection, with integrated web server and support for all common IT standards
- Maximum performance, thanks to high processor speed

Additional features:

- Micro USB interface: for fast startup or changing the PLC settings without knowing the IP address
- 3 integrated Ethernet interfaces for implementing different topologies
- Modbus/TCP is integrated in the firmware - this increases performance and simplifies configuration. This makes communication with other Modbus devices even easier.
- USB A interface for easy firmware update using a USB stick
- Integrated web server for visualization with WebVisit
- FTP server
- Flash file system
- Numerous protocols supported such as: HTTP, FTP, SNMP, SMTP, SQL, MySQL, etc.
- Complete Axiobus master
- Integrated PROFINET controller and integrated PROFINET device

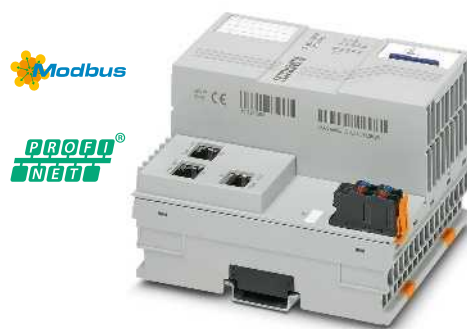

High-performance controller

Interfaces	
Axioline F local bus	
Ethernet	
Parameterization/operation/diagnostics	
AXIOBUS master	
Number of supported devices	
IEC-61131 runtime system	
Programming tool	
Processing speed	
Program memory	
Mass storage	
Retentive mass storage	
Number of data blocks	
Number of timers, counters	
Number of control tasks	
Realtime clock	
Power supply	
Supply voltage	
Supply voltage range	
Typical current consumption	
General data	
Dimensions	W / H / D
Degree of protection	
Ambient temperature (operation)	
EMC note	

Technical data	
Bus base module	
3x RJ45 sockets	
Micro USB type B	
Max. 63	
PC Wox	
3 µs (1 K mix instructions)	
1 µs (1 K bit instructions)	
4 Mbyte	
8 Mbyte	
128 kbyte	
Depends on mass storage	
Depends on mass storage	
16	
Yes	
24 V DC	
19.2 V DC ... 30 V DC	
Typ. 408 mA (without I/Os and U _L = 24 V)	
100 mm / 125.9 mm / 74 mm	
IP20	
-25 °C ... 60 °C (up to 2000 m above sea level)	
Class A product, see page 527	

Description
Axioccontrol , complete with accessories (connector plug and marking field)

Ordering data		
Type	Order No.	Pcs. / Pkt.
AXC 3050	2700989	1

Parameterization memory, flash card without license	
- 2 GB	
- 512 MB	
- 2 GB	
- 512 MB	
Programming cable	

Accessories		
	Order No.	Pcs. / Pkt.
SD FLASH 2GB	2988162	1
SD FLASH 512MB	2988146	1
SD FLASH 2GB APPLIC A	2701190	1
SD FLASH 512MB APPLIC A	2701799	1
CAB-USB A/MICRO USB B/2,0M	2701626	1

Function modules
See page 485

Controllers

Compact controllers

Class 400 controllers

More memory, more speed, more power. The class 400 PROFINET-compatible controllers are the most powerful embedded PLCs from Phoenix Contact. Control demanding automation tasks with maximum performance and intelligent features.

Your advantages:

- Highly flexible, thanks to expansion with numerous I/O modules
- Communication in realtime via PROFINET
- Optimum connection, with integrated web server and support for all common IT standards
- Maximum performance, thanks to high processor speed

Additional features:

- Control and fieldbus system status messages are easily read via the diagnostic display
- Thanks to the powerful processor, comprehensive automation tasks can be processed at maximum speed
- Integrated Ethernet interface
- Integrated web server for visualization with WebVisit
- FTP server
- Flash file system
- Numerous protocols supported such as: HTTP, FTP, SNMP, SMTP, SQL, MySQL, etc.
- Integrated INTERBUS master
- Integrated PROFINET controller and PROFINET device
- Engineering with PC Worx (IEC 61131-3)

The **safety version** offers all the properties of the RFC 470 PN controller and also has an integrated safety controller. This combination can be used to integrate safety functions up to SIL 3 into existing systems.

The use of PROFI-safe reduces wiring effort and installation time.

Notes:
Further information on safety versions can be found in the "Functional Safety" section on page 93.



PLC, with optional integrated safety controller

Interfaces	
INTERBUS (Master)	
Ethernet	
Parameterization/operation/diagnostics	
INTERBUS master	
Number of devices with parameter channel	
Number of supported devices	
Amount of process data	
Direct I/Os	
Connection method	
Number of inputs	
Number of outputs	
IEC-61131 runtime system	
Processing speed	
Program memory	
Mass storage	
Retentive mass storage	
Number of data blocks	
Number of timers, counters	
Number of control tasks	
Realtime clock	
Power supply	
Supply voltage	
Supply voltage range	
Typical current consumption	
General data	
Dimensions	W / H / D
Degree of protection	
Ambient temperature (operation)	
EMC note	

Description	
Remote Field Controller with INTERBUS master	
- 3 x 10/100 Ethernet, PROFINET IO controller	
Safety controller	
Parameterization memory	
- 256 MB	
- 2 GB	
Programming cable , to connect the controller boards to the PC RS-232, length 3 m	
USB memory stick , memory 2 GB, USB 2.0	
RS-232 null modem adapter	
- 9-pos. socket to 9-pos. plug	
Fan module for Remote Field Controller	
AX OPC SERVER , communication interface for OPC-compatible visualization with PC Worx-based controllers	

Technical data	
D-SUB-9 socket	
3x RJ45 sockets	
RS-232-C, D-SUB pin, 10/100 Ethernet (RJ45), 2x USB	
Max. 126	
Max. 512 (of which 254 are remote bus devices/bus segments)	
Max. 8192 Bit (INTERBUS-Master)	
14-pos. FLK pin strip	
5	
3	
0.005 ms (1 K mix instructions)	
1 µs (1 K bit instructions)	
Typ. 8 Mbyte (680 K instructions (IL))	
16 Mbyte	
240 kbyte (NVRAM)	
Depends on mass storage	
Depends on mass storage	
16	
Integrated (battery backup)	
24 V DC	
19.2 V DC ... 30 V DC (including ripple)	
1 A	
124 mm / 185 mm / 190 mm	
IP20	
0 °C ... 55 °C (from 45°C only with fan module)	
Class A product, see page 527	

Ordering data		
Type	Order No.	Pcs. / Pkt.
RFC 470 PN 3TX	2916600	1
RFC 470S PN 3TX	2916794	1

Accessories		
CF FLASH 256MB	2988780	1
CF FLASH 2GB	2701185	1
IBS PRG CAB	2806862	1
2 GB USB STICK	2701382	1
PSM-AD-D9-NULMODEM	2708753	1
RFC DUAL-FAN	2730239	1
AX OPC SERVER	2985945	1

Class 400 controllers

Uninterrupted processes are vital in complex systems and large plants. Ensure the continuous operation of your automation - with the PROFINET redundancy controllers from Phoenix Contact.

The high-performance PLCs establish a redundant system automatically thanks to AutoSync technology.

Your advantages:

- Fast startup and automatic configuration of all redundancy functions, thanks to AutoSync technology
- Uninterrupted process in the event of failure or when a controller is replaced
- Optimum device integration, thanks to PROFINET standards; redundancy for your future-proof Ethernet network
- A distance of up to 80 km between the controllers via fiber optics; cost-optimized thanks to plug-in SFP modules
- High-resolution display for displaying status and error messages in plain text
- Uninterrupted visualization - thanks to redundancy-capable OPC server



AutoSync Technology
Designed by PHOENIX CONTACT



Redundancy PLC



Interfaces	
Ethernet	
Synchronization interface	
Other interfaces	
IEC-61131 runtime system	
Processing speed	
Program memory	
Mass storage	
Retentive mass storage	
Number of data blocks	
Number of timers, counters	
Number of control tasks	
Realtime clock	
Power supply	
Supply voltage	
Supply voltage range	
Typical current consumption	
General data	
Dimensions	W / H / D
Degree of protection	
Ambient temperature (operation)	
EMC note	

Technical data	
3x RJ45 sockets	
SFP port	
2x USB	
0.007 ms (1 K mix instructions)	
2 µs (1 K bit instructions)	
typ. 8 Mbyte (680 K instructions (IL))	
16 Mbyte	
120 kbyte (NVRAM)	
depends on mass storage	
depends on mass storage	
16	
Integrated (battery backup)	
24 V DC	
19.2 V DC ... 30 V DC (including ripple)	
1 A	
124 mm / 185 mm / 190 mm	
IP20	
0 °C ... 55 °C (from 45°C only with fan module)	
Class A product, see page 527	

Description
High-availability remote field controller , thanks to redundancy function
- 3 x 10/100 Ethernet, PROFINET IO controller

Ordering data		
Type	Order No.	Pcs. / Pkt.
RFC 460R PN 3TX	2700784	1

Parameterization memory
- 256 MB
- 2 GB
USB memory stick , memory 2 GB, USB 2.0
Slot module for synchronization port
- Distances of up to 550 m
- Distances of up to 30 km
- Distances of up to 80 km
Synchronization cable for FL SFP SX
- Length 1 m
- Length 2 m
- Length 5 m
Fan module for Remote Field Controller
AX OPC SERVER , communication interface for OPC-compatible visualization with PC Worx-based controllers

Accessories		
Type	Order No.	Pcs. / Pkt.
CF FLASH 256MB	2988780	1
CF FLASH 2GB	2701185	1
2 GB USB STICK	2701382	1
FL SFP SX	2891754	1
FL SFP LX	2891767	1
FL SFP LH	2989912	1
FL MM PATCH 1,0 LC-LC	2989158	1
FL MM PATCH 2,0 LC-LC	2989255	1
FL MM PATCH 5,0 LC-LC	2901799	1
RFC DUAL-FAN	2730239	1
AX OPC SERVER	2985945	1

Controllers

Software PLC

PC Worx RT BASIC PC Worx SRT

Industrial PCs for visualizing and operating processes are often only utilized to a limited extent. Make use of these available resources and also transform your industrial PC into a full-fledged PLC.

Depending on the performance requirements, choose between **PC WORX SRT** with statistically guaranteed response times for small to medium tasks and **PC WORX RT BASIC** for complex automation with realtime requirements.

Your advantages:

- Stable and reliable, thanks to operating system expansion with PC WORX RT BASIC
- Easy and inexpensive visualization, thanks to integrated web server
- Maximum Ethernet openness, as all common protocols are supported

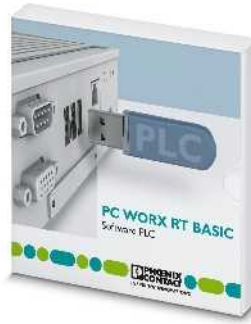

Software PLC
with realtime extension

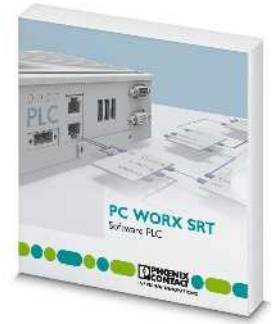

Software PLC
without realtime extension

	Technical data	Technical data
Hardware requirements		
Processor	Min. Intel® Core™2 Duo	Min. Intel® Atom™
Main memory (RAM)	Min. 2 Gbyte	Min. 512 Mbyte
Hard disk memory	Min. 1 Gbyte	Min. 1 Gbyte
Interfaces	Ethernet port, USB port	Ethernet Port
Operating equipment	Keyboard, mouse recommended	Keyboard, mouse recommended
Monitor resolution	XGA (1024 x 768)	XGA (1024 x 768)
Software requirements		
Operating systems	MS Windows® 7 (32 Bit) / MS Windows® Embedded Standard 7 / MS Windows® Embedded 2009 / MS Windows® XP (SP3) / MS Windows® 7 (32-Bit/64-Bit)	MS Windows® 7 (32-Bit/64-Bit) / MS Windows® Embedded Standard 7 / MS Windows® Embedded 2009 / MS Windows® XP (SP3) / -
Supported browsers	Internet Explorer Version 8 or later	Internet Explorer Version 8 or later
Basic functions	Complete PLC PROFINET controller and device functionality only in conjunction with a Valueline PC INTERBUS functionality only in conjunction with an INTERBUS master controller board Integration of Modbus/TCP in the firmware	Complete PLC Non-realtime-capable software PLC for installation on a standard PC with integrated Modbus TCP, plus PROFINET controller and device functionality
IEC-61131 runtime system		
Programmable under	PC Worx in IEC 61131	PC Worx in IEC 61131
Processing speed	0.001 ms (1 K mixed instructions, Core2™ Duo 1.5 GHz) 0.7 µs (1 K bit instructions, Core2™ Duo 1.5 GHz)	5.5 µs (1 K mixed instructions, INTEL ATOM Z510PT) 4 µs (1 K bit instructions, INTEL ATOM Z510PT)
Program memory	8 Mbyte	1 Mbyte
Mass storage	16 Mbyte	1 Mbyte
Retentive mass storage	240 kbyte	48 kbyte
Number of data blocks	Depends on mass storage	Depends on mass storage
Number of timers, counters	Depends on mass storage	Depends on mass storage
Number of control tasks	16	8

	Ordering data			Ordering data		
Description	Type	Order No.	Pcs. / Pkt.	Type	Order No.	Pcs. / Pkt.
Software PLC, with realtime extension	PC Worx RT BASIC	2700291	1	PC Worx SRT	2701680	1
Software PLC, without realtime extension						
	Accessories			Accessories		
Industrial computer	VALUELINE IPC	2913108	1	VALUELINE IPC	2913108	1
PC controller board	IBS PCI SC/I-T	2725260	1	AX OPC SERVER	2985945	1
AX OPC SERVER, communication interface for OPC-compatible visualization with PC Worx-based controllers	AX OPC SERVER	2985945	1			

new

Function blocks

Function blocks from Phoenix Contact can be used to extend your system quickly and easily with the following functions:

- Energy measurement
- Motor management
- Control technology
- Network protocols
- IT security
- Network management
- Databases
- CAN bus
- Remote control protocols (Resy+)
- webMI functionality of atvise®

Your advantages:

- High quality for every application, thanks to documented and tested program parts
- Fast startup of I/O components and error-free configuration, thanks to specially adapted blocks
- Ready-made function blocks reduce programming effort and help prevent programming errors
- Function blocks even for complex applications such as controllers
- Unlimited communication, as network protocols can be accessed from the control program
- Easy infrastructure integration
- Maximum safety, thanks to the support and ongoing development of products by Phoenix Contact

Memory cards with and without license

Memory cards are used to configure the parameterization memory of controllers and for licensing function block libraries. You can choose between 512 Mbytes or 2 Gbytes for SD cards or between 256 Mbytes and 2 Gbytes for CF cards.

If the memory cards are listed with the extension APPLIC A or a function, they include a corresponding license for function block libraries.



CF and SD memory card with function block licenses

Description
Parameterization memory , flash card without license
- 2 GB
- 2 GB
- 512 MB
- 256 MB
Function block libraries for IT applications , for MS SQL/MY SQL communication and for PID controllers, Flash card with license for activation
- 2 GB
- 2 GB
- 512 MB
- 256 MB
Function block libraries for IT applications , for using the webMI functionality of atvise®, Flash card
- 2 GB
- 2 GB, with license for activation
Controller function blocks with self-optimization for temperature control, Flash card with license for activation
- 512 MB
- 256 MB
Controller function blocks with self-optimization , extended with special functions for process automation, Flash card with license for activation
- 512 MB
- 256 MB
License key function block library for remote control technology
Multiplexer application on SD card for configuring two ILC 131 ETH controllers as a multiplexer

Ordering data			
Type	Order No.	Pcs. / Pkt.	
SD FLASH 2GB	2988162	1	
CF FLASH 2GB	2701185	1	
SD FLASH 512MB	2988146	1	
CF FLASH 256MB	2988780	1	
SD FLASH 2GB APPLIC A	2701190	1	
CF FLASH 2GB APPLIC A	2701189	1	
SD FLASH 512MB APPLIC A	2701799	1	
CF FLASH 256MB APPLIC A	2988793	1	
SD FLASH 2GB ATVISE	2400088	1	
SD FLASH 2GB APPLIC A ATVISE	2400089	1	
SD FLASH 512MB PDPI BASIC	2701800	1	
CF FLASH 256MB PDPI BASIC	2700549	1	
SD FLASH 512MB PDPI PRO	2701801	1	
CF FLASH 256MB PDPI PRO	2700550	1	
RESY-DATA-A LIC	2876847	1	
SD FLASH 512MB MODULAR MUX	2701872	1	

PROFINET starter kit

new

The new PROFINET starter kit provides a cost-effective introduction to discovering the advantages of PROFINET technology. Here, the latest, robust components are integrated with an automation station consisting of an Axiocontrol PLC and Axioline F I/O system. You can therefore build your own test and learning application.

Your advantages:

- Fast introduction to automation with PROFINET, thanks to step-by-step instructions for the test structure
- Structure with the latest automation station based on Axiocontrol and Axioline components
- Get started straight away with a set of all the necessary products



PROFINET starter kit

Technical data

See AXC 1050 on page 480

Ordering data

Description
PROFINET starter kit , incl. AXC 1050 controller, bus coupler, I/O modules, power supply, and cables as well as PC Worx software with quick start guide and application example

Type	Order No.	Pcs. / Pkt.
AXC 1050 PN STARTERKIT	2400361	1

ILC 131 starter kit

The ILC 131 starter kit provides an easy introduction to our controllers. Learn about control technology with the aid of a pre-assembled test structure with programmed examples. Then use the PC Worx Express programming software to create custom solutions.

Begin by starting up the controller, configure it, and parameterize the bus structure. With the test structure, enter the world of IEC 61131-3-compliant programming.

Controller performance data at a glance:

- Supply voltage: 24 V DC
- Integrated inputs /outputs: 8 / 4
- Processing time per 1000 instructions: 90 µs (bit data types), 1.7 ms (mixed data types)
- Program / mass storage: 192 kB / 192 kB
- Remanent mass storage: 8 kB

Ethernet



Pre-assembled test structure for a fast introduction

Description
ILC 131 starter kit, incl. ILC 131 ETH, analog input module, control panel, power supply unit, plus accessories and cables with test application set up

Programming cable
AX OPC SERVER, communication interface for OPC-compatible visualization with PC Worx-based controllers

Technical data

See ILC 131 ETH on page 474

Ordering data

Type	Order No.	Pcs. / Pkt.
ILC 131 STARTERKIT	2701835	1

Accessories

COM CAB MINI DIN	2400127	1
AX OPC SERVER	2985945	1



Whatever your automation task: our specialists in the AUTOMATIONWORX Competence Center are available to answer any questions you may have. This is made possible by our flexible service concept.

Based on the typical phases of a project, we work with you at each stage. With our expertise and years of experience we provide support that is tailored to your industry and the specific phase of your project.

Your advantages:

- Save time by transferring automation solutions thanks to comprehensive technology and product expertise
- Sophisticated process management thanks to the consistent consideration of all requirements
- Target-oriented project management with optimally coordinated process steps
- Traceable, legal protection thanks to consistent documentation

Services for Functional Safety can be found on page 94.

Services for Industrial Ethernet can be found on page 324.



Service

You can rely on our support for the smooth operation of your application. Our experts deal with queries encountered in practical applications every day. They draw on their experience of all sectors and knowledge of the components and technologies used.

Our service specialists will be happy to support you with the following services:

- Hotline
- On-site service
- Startup support
- Professional workshops

If queries arise during startup and operation, in addition to your local specialists you can also contact our free 24-hour hotline at any time (+ 49 5281 9-462888) or e-mail us on automation-service@phoenixcontact.com

We will be happy to answer general questions regarding the functionality of individual components or the system. If this is not sufficient, our startup support team and on-site service will be there to provide assistance.



Training

Discover the added value our individual training concepts and training services offer. With our tailor-made concepts, we help you and your employees to make optimum use of the control and I/O systems from Phoenix Contact.

With our free consultation service, you can arrange with us the contents, duration, location, and date of your individual training session.

Should you have any queries regarding our training services and qualification concepts, please contact your local contact person or contact our Back Office Training team directly (+ 49 5281 9-462161) or e-mail us on automation-training@phoenixcontact.com

We will happily advise you on the implementation of your qualification requirements and work with you to create your own individual training program.

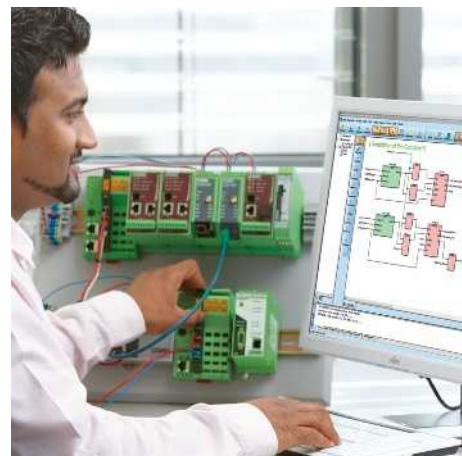

Engineering

Whatever your automation task: our engineering specialists are available to answer any questions you may have. Based on the typical phases of a project, we work with you at each stage.

With our expertise and years of experience we provide support that is tailored to your industry and the specific phase of your project.

Simply give us an outline of the applications you would like to implement and we will provide you with a technical concept that includes suitable hardware and software.

- Configuration
- Programming
- Visualization
- Coaching



Wireless data communication

Signals that could previously only be acquired with a great deal of effort, or not at all, can now be acquired and transmitted quickly and efficiently using wireless systems.

Wireless LAN

WLAN is a wireless standard according to IEEE 802.11 a/b/g/n for creating wireless local area networks.

- High data rates of up to 54 Mbps or 300 Mbps
- Fast roaming
- Device mobility in wide area networks
- High degree of reliability thanks to MIMO (multiple input, multiple output) technology

Trusted Wireless

Trusted Wireless is a form of wireless technology that has been designed specifically for industrial applications.

- Long range from a few hundred meters to several kilometers
- Robust and reliable communication in industrial environments
- License-free ISM band
- High local system density of several hundred networks possible
- Can be operated in parallel with WLAN 802.11 and Bluetooth systems without interference
- FHSS method for high immunity to interference

Bluetooth

With Bluetooth, you can configure local wireless networks with up to seven devices.

- Range of up to 100 m in industrial halls and up to 200 m outdoors
- Cyclic and fast data transmission of small data packets
- High local system density, i.e., WLAN 802.11 systems can be operated in parallel without interference
- High data security thanks to 128-bit data encryption and device authentication
- FHSS method for high immunity to interference

WirelessHART

WirelessHART is a transmission technology intended for process automation.

- Wireless module according to IEEE 802.15.4
- Time-synchronized communication
- Supports fully meshed networks
- Secure data transfer

Product overview	492
<hr/>	
Wireless Ethernet	
Industrial WLAN	494
Industrial Bluetooth	496
<hr/>	
Wireless I/O / Wireless Serial	
Radioline wireless transceivers (2.4 GHz, 900 MHz, 868 MHz)	499
<hr/>	
Wireless I/O	
I/O extension modules	500
Bluetooth wireless modules (2.4 GHz)	504
WirelessHART gateway and adapter (2.4 GHz)	506
<hr/>	
Wireless Serial	
Bluetooth interface converter (2.4 GHz)	508
<hr/>	
Trusted Wireless Ethernet	
RAD-Line wireless transceiver (2.4 GHz, 900 MHz)	510
I/O extension modules	512
<hr/>	
Antennas and cables	514
<hr/>	
Mobile communication	394

Wireless data communication

Product overview

Wireless Ethernet



Industrial WLAN – WLAN access point and Ethernet adapter

Page 494



Industrial Bluetooth – access point and Ethernet adapter

Page 496

Wireless I/O / Wireless Serial



2.4 GHz – wireless transceiver for serial interfaces

Page 499



868 MHz – wireless transceiver for serial interfaces

Page 499



900 MHz – wireless transceiver for serial interfaces

Page 499

Wireless Serial



Bluetooth converter

Page 508

Wireless I/O



Analog/digital I/O module, 2 digital I/Os and 1 analog I/O

Page 500



Digital I/O modules, 4 inputs or 4 relay outputs, 8 inputs or 8 transistor outputs

Page 500



Analog I/O modules, 4 inputs or 4 outputs

Page 502



Temperature I/O module, 4 Pt 100 inputs

Page 503

Wireless I/O



Bluetooth wireless modules (2.4 GHz) Wireless multiplexer with antennas

Page 504



Bluetooth wireless modules (2.4 GHz) Fieldline Modular Wireless with antenna

Page 505

WirelessHART



WirelessHART gateway

Page 506



WirelessHART adapter

Page 507

Trusted Wireless Ethernet



900 MHz – wireless transceiver with Trusted Wireless, for Ethernet Page 510



2.4 GHz – wireless transceiver with WLAN 802.11b/g, for Ethernet Page 511

Trusted Wireless Ethernet



Analog module for four inputs or four outputs Page 512



Digital module for eight inputs or eight outputs Page 512



Analog/digital module for two digital I/Os and one analog I/O Page 513



Digital module for two counter/frequency inputs or two counter/frequency outputs Page 513

Mobile communication



Mobile communication – mobile phone routers with firewall and VPN Page 394



Mobile communication – MGUARD security routers Page 397

Antennas and cables



Antennas Page 514



Adapters, extension cables Page 522

Wireless Ethernet

WLAN access point

The latest generation of WLAN modules offers maximum reliability, data throughput, and range.

Faster

- The new high-speed WLAN 5100 brings WLAN 802.11n to industrial applications and with it a data rate of up to 300 Mbps

Configuration

- Central cluster management enables the entire wireless network to be set up in just minutes

More reliable

- MiMo technology with three antennas for wireless communication that is more robust, faster, and covers a wider range

Notes:

* The range may be considerably above or below that stated. It is dependent on the environment, antenna technology, and the product used.

Please visit phoenixcontact.com, for more information on the prevailing country-specific approvals for the relevant product.

WLAN



**WLAN access point/2.4 GHz, 5 GHz client
802.11 a/b/g/n**

ERC
Ex:

Technical data	
Wireless interface	IEEE 802.11
Wireless standard	2.4 GHz / 5 GHz
Frequency band	Max. 23 dBm (EIRP)
Transmission power	RSMA (socket)
Antenna connection method	3
Number	Antennas not included in scope of supply
Antenna	2
Assembly instructions	RJ45 socket
Ethernet ports	24 V DC
Number	Via COMBICON
Connection method	10 V DC ... 36 V DC
Power supply for module electronics	200 mA
Supply voltage	802.11i
Connection method	WPA PSK (pre-shared key)
Supply voltage range	WPA2
Supply current	AES
Security	TKIP
	Supports 802.1X/RADIUS
	MAC filter
Function	Access point/client adapter/repeater/WDS bridge
Operating modes	SNMP (V2/V3), CLI, WPS, DHCP, DCP, BootP, HTTP, HTTPS, Syslog, SD card, dual FW image, 1 x DI, 1 x DO, 2 x Ethernet 10/100 Mbit, auto crossover, auto negotiation, MODE button
Basic functions	Cluster management, web-based management, WPS
Configuration	EU, more countries in e-shop
General data	40 mm / 109 mm / 109 mm
Wireless licenses	IP20
Dimensions	-25 °C ... 60 °C (extended temperature range on request)
Degree of protection	10 % ... 95 % (non-condensing)
Ambient temperature (operation)	800 hPa ... 1080 hPa (up to 2000 m above sea level)
Permissible humidity (operation)	30g
Air pressure (operation)	5g
Shock according to EN 60068-2-27/IEC 60068-2-27	
Vibration resistance according to EN 60068-2-6/IEC 60068-2-6	

Description
Wireless LAN Access Point
- WLAN 802.11 a,b,g,n, frequency 2.4 GHz, 5 GHz, IP20
- Approval for the USA and Canada
- Approval for Japan

Parameterization memory, flash card without license
Control cabinet set, IP66, including DIN rail, plugs, and screw connections
- With 3 omnidirectional antennas and antenna cables
- With 3 omnidirectional antennas, antenna cables, and 100 ... 240 V AC power supply
- With one panel antenna, antenna cable, and 100 ... 240 V AC power supply

Ordering data		
Type	Order No.	Pcs. / Pkt.
FL WLAN 5100	2700718	1
FL WLAN 5101	2701093	1
FL WLAN 5102	2701850	1

Accessories		
SD FLASH 2GB	2988162	1
FL robust BOX	2701204	1
FL robust BOX OMNI-1	2701430	1
FL robust BOX OMNI-2	2701439	1
FL robust BOX DIR-1	2701440	1

Industrial WLAN

Factoryline WLAN devices have been developed specifically for use under harsh industrial conditions.

Features:

- Maximum security according to IEEE 802.11i with AES encryption
- 2.4 GHz and 5 GHz supported
- High resistance to vibration, shock, and EMI
- Range of several hundred meters*



WLAN Ethernet adapter with internal panel antenna 2.4/5 GHz



WLAN Ethernet adapter with external antenna connection



Technical data	
FL WLAN EPA	FL WLAN EPA 5N
Wireless interface	
Wireless standard	
IEEE 802.11	
Frequency band	
2.4 GHz	5 GHz
Transmission power	
Max. 20 dBm (EIRP)	Max. 14 dBm (EIRP)
Antenna connection method	
(Internal)	
Antenna	
Connection method	
Permanently installed	
Assembly instructions	
Internal circularly polarized panel antenna	
Ethernet ports	
Connection method	
M12 connector (D-coded, socket))	
Power supply for module electronics	
Supply voltage	
24 V DC	
Connection method	
M12 connector (A-coded, pin)	
Supply voltage range	
9 V DC ... 30 V DC	
Supply current	
76 mA (at 24 V DC)	
Security	
802.11i	
WPA PSK (presheared key)	
WPA2 PSK	
AES	
WEP 64 bit/128 bit	
TKIP	
Supports 802.1X/RADIUS	
Function	
Operating modes	
Ethernet client adapter	
Configuration	
Web interface, MODE button, AT commands (TCP/IP), SSC	
General data	
Wireless licenses	
Europe, USA, Canada, additional countries in the e-shop	
Dimensions	
W / H / D	
66 mm / 91 mm / 34 mm	
Degree of protection	
IP65	
Ambient temperature (operation)	
-40 °C ... 65 °C	
Permissible humidity (operation)	
5 % ... 90 % (non-condensing)	
Air pressure (operation)	
795 hPa ... 1080 hPa (up to 2000 m above sea level)	
Mounting type	
Wall mounting	

Technical data	
Wireless interface	
Wireless standard	
IEEE 802.11	
Frequency band	
2.4 GHz/5 GHz	
Transmission power	
Max. 20 dBm (EIRP)	
Antenna connection method	
RSMA (socket)	
Antenna	
Connection method	
RSMA (pin)	
External OMNI omnidirectional antenna supplied as standard, antennas can be exchanged	
Assembly instructions	
M12 connector (D-coded, socket))	
Power supply for module electronics	
Supply voltage	
24 V DC	
Connection method	
M12 connector (A-coded, pin)	
Supply voltage range	
9 V DC ... 30 V DC	
Supply current	
76 mA (at 24 V DC)	
Security	
802.11i	
WPA PSK (presheared key)	
WPA2 PSK	
AES	
WEP 64 bit/128 bit	
TKIP	
Supports 802.1X/RADIUS	
Function	
Operating modes	
Ethernet client adapter	
Configuration	
Web interface, MODE button, AT commands (TCP/IP), SSC	
General data	
Wireless licenses	
Europe, USA, Canada, additional countries in the e-shop	
Dimensions	
66 mm / 91 mm / 34 mm	
Degree of protection	
IP65	
Ambient temperature (operation)	
-40 °C ... 65 °C	
Permissible humidity (operation)	
5 % ... 90 % (non-condensing)	
Air pressure (operation)	
795 hPa ... 1080 hPa (up to 2000 m above sea level)	
Mounting type	
Wall mounting	

Ordering data		
Type	Order No.	Pcs. / Pkt.
FL WLAN EPA	2692791	1
FL WLAN EPA 5N	2700488	1

Ordering data		
Type	Order No.	Pcs. / Pkt.
FL WLAN EPA RSMA	2701169	1

Accessories		
Accessories	Order No.	Pcs. / Pkt.
FL EPA WMS	2701134	1
FL EPA RMS	2701133	1

Accessories		
Accessories	Order No.	Pcs. / Pkt.
FL EPA WMS	2701134	1
FL EPA RMS	2701133	1

Description	
Wireless LAN Ethernet port adapter	
- Internal 2.4 GHz panel antenna	
- Internal 5 GHz panel antenna	
- External RSMA antenna connection (socket)	
Mounting material, for wall or mast mounting	
Mounting material, for DIN rail mounting	

Industrial Bluetooth

Bluetooth modules for the wireless integration of Ethernet-capable devices in the control network. Optimized for use in PROFINET/PROFIsafe networks.

Features:

- Protocol-transparent communication on Layer 2
- WLAN coexistence functions AFH, LEM, black channel listing
- Integrated special antenna (EPA)
- Range* of up to 200 m
- Reliable wireless transmission of safety-related data signals using SafetyBridge technology

Notes:

* The range may be considerably above or below that stated. It is dependent on the environment, antenna technology, and the product used.

Please visit phoenixcontact.com, for more information on the prevailing country-specific approvals for the relevant product.



Bluetooth access point



Wireless interface	
Wireless standard	Bluetooth 2.1 + EDR
Frequency range	2.402 GHz ... 2.48 GHz (ISM bandwidth)
Transmission power	Max. 12 dBm (EIRP)
Wireless modules that can be connected	7
Profiles supported	PAN
Antenna connection method	RSMA (socket)
Antenna	
Connection method	RSMA (pin)
Assembly instructions	External OMNI omnidirectional antenna supplied as standard, antennas can be exchanged
Ethernet ports	
Connection method	M12 connector (D-coded, socket)
Power supply for module electronics	
Supply voltage	24 V DC
Connection method	M12 connector (A-coded, pin)
Supply voltage range	9 V DC ... 30 V DC
Current consumption	46 mA (at 24 V DC)
Security	
	128-bit data encryption
	Authentication
	PIN
	Non-discoverable
Function	
Operating modes	BT access point
Function	P2P Client Access point
Configuration	Web interface, MODE button, AT commands (TCP/IP), SSC
General data	
Wireless licenses	Europe, additional countries in the e-shop
Dimensions	66 mm / 91 mm / 34 mm
Degree of protection	IP65
Protection class	III, IEC 61140, EN 61140, VDE 0140-1
Ambient temperature (operation)	-40 °C ... 65 °C
Permissible humidity (operation)	5 % ... 90 % (non-condensing)
Air pressure (operation)	795 hPa ... 1080 hPa (up to 2000 m above sea level)

Technical data

Technical data	
Bluetooth 2.1 + EDR	2.402 GHz ... 2.48 GHz (ISM bandwidth)
Max. 12 dBm (EIRP)	7
PAN	RSMA (socket)
RSMA (pin)	External OMNI omnidirectional antenna supplied as standard, antennas can be exchanged
M12 connector (D-coded, socket)	
24 V DC	M12 connector (A-coded, pin)
9 V DC ... 30 V DC	46 mA (at 24 V DC)
128-bit data encryption	
Authentication	
PIN	
Non-discoverable	
BT access point	
P2P	
Client	
Access point	
Web interface, MODE button, AT commands (TCP/IP), SSC	

Description	
Bluetooth Access Point	
Bluetooth Ethernet Client adapter	
Protocol-transparent Ethernet wireless path	

Ordering data

Type	Order No.	Pcs. / Pkt.
FL BT EPA MP	2701416	1

Mounting material, for wall or mast mounting	
Mounting material, for DIN rail mounting	

Accessories

Type	Order No.	Pcs. / Pkt.
FL EPA WMS	2701134	1
FL EPA RMS	2701133	1



Bluetooth Ethernet adapter



Solution set, including cable

Ex:

Technical data
Bluetooth 2.1 + EDR 2.402 GHz ... 2.48 GHz (ISM bandwidth) Max. 15 dBm (EIRP) 1 PAN (Internal)
Permanently installed Internal circularly polarized panel antenna
M12 connector (D-coded, socket)
24 V DC M12 connector (A-coded, pin) 9 V DC ... 30 V DC 46 mA (at 24 V DC)
128-bit data encryption Authentication PIN Non-discoverable
Ethernet client adapter P2P Client
Web interface, MODE button, AT commands (TCP/IP), SSC
Europe, additional countries in the e-shop 66 mm / 91 mm / 34 mm IP65 III, IEC 61140, EN 61140, VDE 0140-1 -40 °C ... 65 °C 5 % ... 90 % (non-condensing) 795 hPa ... 1080 hPa (up to 2000 m above sea level)

Technical data
Bluetooth 2.1 + EDR 2.402 GHz ... 2.48 GHz (ISM bandwidth) Max. 15 dBm (EIRP) 1 PAN (Internal)
Permanently installed Internal circularly polarized panel antenna
M12 connector (D-coded, socket)
24 V DC M12 connector (A-coded, pin) 9 V DC ... 30 V DC 46 mA (per module at 24 V DC)
128-bit data encryption Authentication PIN Non-discoverable
Ethernet client adapter P2P Bridge
Web interface, MODE button, AT commands (TCP/IP), SSC
Europe, additional countries in the e-shop 66 mm / 91 mm / 34 mm IP65 III, IEC 61140, EN 61140, VDE 0140-1 -40 °C ... 65 °C 5 % ... 90 % (non-condensing) 795 hPa ... 1080 hPa (up to 2000 m above sea level)

Ordering data		
Type	Order No.	Pcs. / Pkt.
FL BT EPA	2692788	1

Ordering data		
Type	Order No.	Pcs. / Pkt.
FL BT EPA AIR SET	2693091	1

Accessories		
Type	Order No.	Pcs. / Pkt.
FL EPA WMS	2701134	1
FL EPA RMS	2701133	1

Accessories		
Type	Order No.	Pcs. / Pkt.
FL EPA WMS	2701134	1
FL EPA RMS	2701133	1

Easy startup with I/O mapping - the Radioline wireless system



Radioline is the new wireless system for large systems and networks. Special features include extremely easy assignment of inputs and outputs by simply turning the thumb wheel - without any programming.

Radioline transmits I/O signals as well as serial data and is therefore very versatile. In addition, you can implement various network structures: from a simple point-to-point connection to complex mesh networks.

Thanks to the latest Trusted Wireless technology, Radioline is the ideal choice for industrial use.

Network applications

- I/O data mode: simple I/O signal distribution in the network
- PLC/Modbus RTU mode: I/O integration in the control level using the Modbus protocol
- Serial data mode: networking of controllers and serial I/O devices, simple RS-232/RS-485 cable replacement

What advantages does I/O mapping offer?

I/O mapping makes it considerably easier to assign input and output signals in your systems. With a slight turn of the thumb wheel, you can distribute and multiply I/O signals freely in your network – without the need for any complex programming.

Trusted Wireless

Trusted Wireless technology is specifically designed for the reliable transmission of data and signals over long distances.

The new Version 2.0 also offers functions such as adjustable data rates, encryption, extended diagnostics, and parallel operation of multiple networks.

The range* depends on the wireless system selected:

- 2.4 GHz - up to 5 km
- 868 MHz - up to 20 km
- 900 MHz - up to 32 km

Notes:

*The range may be considerably above or below that stated. It is dependent on the environment, antenna technology, transmission power, and the product used.

The latest country registrations for the relevant product can be found on the Internet at phoenixcontact.com.

Wireless path

Direction
Frequency range
Data rate (adjustable)

Number of channels
Security
Connection method
Serial port
Connection method

Serial transmission speed
Termination resistor (switchable via DIP switches)

Analog output

Signal range

Digital output

Contact type
Switching voltage
Switching current

General data

Supply voltage
Current consumption
Degree of protection
Ambient temperature range
Permissible humidity (operation)
Dimensions
Screw connection solid / stranded / AWG
EMC note

W / H / D

Conformance / approvals

Conformance

ATEX
IECEX
UL, USA / Canada

Description

Wireless module

- can be extended with I/O extension modules

Conf. stick, configuration memory for network addressing

RF band 1
RF band 3
RF band 5
RF band 7

Memory stick, for saving custom configuration data

USB cable, for diagnostics and extended configuration



Ex n



2.4 GHz wireless transceiver, for worldwide use



Ex n



868 MHz wireless transceiver, for license-free use in Europe



Distributed Network Protocol



900 MHz wireless transceiver, for license-free use in America



Housing width 17.5 mm

Housing width 17.5 mm



Housing width 35 mm

Technical data

Bi-directional	
2.4002 GHz ... 2.4785 GHz	
16 kbps / 125 kbps / 250 kbps	
8 x 55	
128-bit data encryption	
RSMA (socket)	
RS-232	RS-485
COMBICON plug-in screw terminal block	COMBICON plug-in screw terminal block
0.3 ... 115.2 kbps	0.3 ... 187.5 kbps
-	390 Ω / 150 Ω / 390 Ω
RSSI voltage output	
0 V ... 3 V	
RF link relay output	
PDT	
30 V AC / 60 V DC	
500 mA	
19.2 V DC ... 30.5 V DC	
≤ 65 mA (@ 24 V DC, @ 25°C, stand-alone)	
IP20	
-40 °C ... 70 °C	
20 % ... 85 %	
17.5 / 99 / 114.5 mm	
0.2 ... 2.5 mm ² / 0.2 ... 2.5 mm ² / 24 - 14	
Class A product, see page 527	
CE compliance (R&TTE directive 1999/5/EC)	
FCC Directive, Part 15.247	
ISC Directive RSS 210	
Ex II 3 G Ex nA nC IIC T4 Gc X	
Ex nA nC IIC T4 Gc	
UL 508 Listed	
Class I, Div. 2, Groups A, B, C, D T4A	
Class I, Zone 2, IIC T4	

Technical data

Bi-directional	
869.4 MHz ... 869.65 MHz	
1.2 kbps / 9.6 kbps / 19.2 kbps / 60 kbps / 120 kbps	
14	
128-bit data encryption	
RSMA (socket)	
RS-232	RS-485
COMBICON plug-in screw terminal block	COMBICON plug-in screw terminal block
0.3 ... 115.2 kbps	0.3 ... 115.2 kbps
-	390 Ω / 150 Ω / 390 Ω
RSSI voltage output	
0 V ... 3 V	
RF link relay output	
PDT	
30 V AC / 60 V DC	
500 mA	
19.2 V DC ... 30.5 V DC	
≤ 65 mA (@ 24 V DC, @ 25°C, stand-alone)	
IP20	
-40 °C ... 70 °C	
20 % ... 85 %	
17.5 / 99 / 114.5 mm	
0.2 ... 2.5 mm ² / 0.2 ... 2.5 mm ² / 24 - 14	
CE compliance (R&TTE directive 1999/5/EC)	
ATEX applied for	
IECEX applied for	
-	

Technical data

Bi-directional	
902 MHz ... 928 MHz	
16 kbps / 125 kbps / 250 kbps / 500 kbps	
-	
128-bit data encryption	
RSMA (socket)	
RS-232	RS-485
COMBICON plug-in screw terminal block	COMBICON plug-in screw terminal block
0.3 ... 115.2 kbps	0.3 ... 115.2 kbps
-	390 Ω / 150 Ω / 390 Ω
RSSI voltage output	
0 V ... 3 V	
RF link relay output	
PDT	
30 V AC/DC	
500 mA	
10.8 V DC ... 30.5 V DC	
328 mA (@24 V DC)	
IP20	
-40 °C ... 70 °C	
20 % ... 85 %	
35 / 99 / 114.5 mm	
0.2 ... 2.5 mm ² / 0.2 ... 2.5 mm ² / 24 - 14	
FCC Directive, Part 15.247	
ISC Directive RSS 210	
-	
-	
Class I, Div. 2, Groups A, B, C, D	

Ordering data		
Type	Order No.	Pcs. / Pkt.
RAD-2400-IFS	2901541	1

Ordering data		
Type	Order No.	Pcs. / Pkt.
RAD-868-IFS	2904909	1

Ordering data		
Type	Order No.	Pcs. / Pkt.
RAD-900-IFS	2901540	1

Accessories		
Type	Order No.	Pcs. / Pkt.
RAD-CONF-RF3	2902814	1
RAD-CONF-RF5	2902815	1
RAD-CONF-RF7	2902816	1
RAD-MEMORY	2902828	1
RAD-CABLE-USB	2903447	1

Accessories		
Type	Order No.	Pcs. / Pkt.
RAD-868-CONF-RF1	2702197	1
RAD-MEMORY	2902828	1
RAD-CABLE-USB	2903447	1

Accessories		
Type	Order No.	Pcs. / Pkt.
RAD-900-CONF-RF1	2702122	1
RAD-MEMORY	2902828	1
RAD-CABLE-USB	2903447	1

Wireless I/O

I/O extension modules

- Easy I/O mapping via thumb wheel
- Digital wide-range inputs (0 ... 250 V AC/DC)
- 0 ... 100 Hz digital pulse inputs
- Relay or transistor outputs
- Easy module replacement even during operation (hot swap)
- Extended temperature range (-40°C ... +70°C)



I/O extension module,
2 digital inputs/outputs and
1 analog input/output



I/O extension module,
4 digital inputs

Ex:
Housing width 17.5 mm

Ex:
Housing width 17.5 mm

Technical data

Technical data

Analog input	
Number of inputs	1
Resolution	16 (Bit)
Signal range (configurable using the DIP switch)	0 mA ... 20 mA / 4 mA ... 20 mA
Accuracy	≤ 0.02 % (@25°C)
Supply voltage	≥ 12 V DC (For passive sensors (via terminal PWR1, +11))
Digital input	
Number of inputs	2
Switching level	1 signal ("H") 10 V AC/DC ... 50 V AC/DC (Low-voltage input) 50 V AC/DC ... 250 V AC/DC (High-voltage input)
Switching level	0 signal ("L") 0 V AC/DC ... 4 V AC/DC (Low-voltage input) 0 V AC/DC ... 20 V AC/DC (High-voltage input)
Input frequency	≤ 2 Hz
Pulse input	
Number of inputs	-
Signal range	-
Input frequency	-
Pulse length	-
Analog output	
Number of outputs	1
Signal range	0 mA ... 20 mA 0 V ... 10 V 4 mA ... 20 mA
Accuracy	≤ 0.02 % (@25°C) typ. 0.5 %
Load R _B	≤ 500 Ω ≥ 10 kΩ
Digital output	
Contact type	2 x Relay output
Switching voltage	250 V AC 24 V DC
Switching current	min./max. ≥ 10 mA / 2 A
Switching frequency	2 Hz
General data	
Supply voltage	19.2 V DC ... 30.5 V DC (TBUS)
Current consumption	≤ 95 mA (At 24 V DC, at 25°C)
Degree of protection	IP20
Ambient temperature range	-40 °C ... 70 °C
Dimensions	W / H / D 17.5 / 99 / 114.5 mm
EMC note	Class A product, see page 527
Conformance / approvals	
Conformance	CE-compliant
ATEX	II 3 G Ex nA nC IIC T4 Gc X
IECEX	Ex nA nC IIC T4 Gc
UL, USA / Canada	UL 508 Listed Class I, Div. 2, Groups A, B, C, D T4A Class I, Zone 2, IIC T4

Technical data	
Ex: Housing width 17.5 mm	
Analog input	
Number of inputs	1
Resolution	16 (Bit)
Signal range (configurable using the DIP switch)	0 mA ... 20 mA / 4 mA ... 20 mA
Accuracy	≤ 0.02 % (@25°C)
Supply voltage	≥ 12 V DC (For passive sensors (via terminal PWR1, +11))
Digital input	
Number of inputs	4
Switching level	10 V AC/DC ... 50 V AC/DC (Low-voltage input) 50 V AC/DC ... 250 V AC/DC (High-voltage input)
Switching level	0 V AC/DC ... 4 V AC/DC (Low-voltage input) 0 V AC/DC ... 20 V AC/DC (High-voltage input)
Input frequency	≤ 2 Hz
Pulse input	
Number of inputs	-
Signal range	-
Input frequency	-
Pulse length	-
Analog output	
Number of outputs	1
Signal range	0 mA ... 20 mA 0 V ... 10 V 4 mA ... 20 mA
Accuracy	≤ 0.02 % (@25°C) typ. 0.5 %
Load R _B	≤ 500 Ω ≥ 10 kΩ
Digital output	
Contact type	2 x Relay output
Switching voltage	250 V AC 24 V DC
Switching current	min./max. ≥ 10 mA / 2 A
Switching frequency	2 Hz
General data	
Supply voltage	19.2 V DC ... 30.5 V DC (TBUS)
Current consumption	≤ 11 mA (At 24 V DC, at 25°C)
Degree of protection	IP20
Ambient temperature range	-40 °C ... 70 °C
Dimensions	W / H / D 17.5 / 99 / 114.5 mm
EMC note	Class A product, see page 527
Conformance / approvals	
Conformance	CE-compliant
ATEX	II 3 G Ex nA nC IIC T4 Gc X
IECEX	Ex nA nC IIC T4 Gc
UL, USA / Canada	UL 508 Listed Class I, Div. 2, Groups A, B, C, D T4A Class I, Zone 2, IIC T4

Technical data	
Ex: Housing width 17.5 mm	
Analog input	
Number of inputs	1
Resolution	16 (Bit)
Signal range (configurable using the DIP switch)	0 mA ... 20 mA / 4 mA ... 20 mA
Accuracy	≤ 0.02 % (@25°C)
Supply voltage	≥ 12 V DC (For passive sensors (via terminal PWR1, +11))
Digital input	
Number of inputs	4
Switching level	10 V AC/DC ... 50 V AC/DC (Low-voltage input) 50 V AC/DC ... 250 V AC/DC (High-voltage input)
Switching level	0 V AC/DC ... 4 V AC/DC (Low-voltage input) 0 V AC/DC ... 20 V AC/DC (High-voltage input)
Input frequency	≤ 2 Hz
Pulse input	
Number of inputs	-
Signal range	-
Input frequency	-
Pulse length	-
Analog output	
Number of outputs	1
Signal range	0 mA ... 20 mA 0 V ... 10 V 4 mA ... 20 mA
Accuracy	≤ 0.02 % (@25°C) typ. 0.5 %
Load R _B	≤ 500 Ω ≥ 10 kΩ
Digital output	
Contact type	2 x Relay output
Switching voltage	250 V AC 24 V DC
Switching current	min./max. ≥ 10 mA / 2 A
Switching frequency	2 Hz
General data	
Supply voltage	19.2 V DC ... 30.5 V DC (TBUS)
Current consumption	≤ 11 mA (At 24 V DC, at 25°C)
Degree of protection	IP20
Ambient temperature range	-40 °C ... 70 °C
Dimensions	W / H / D 17.5 / 99 / 114.5 mm
EMC note	Class A product, see page 527
Conformance / approvals	
Conformance	CE-compliant
ATEX	II 3 G Ex nA nC IIC T4 Gc X
IECEX	Ex nA nC IIC T4 Gc
UL, USA / Canada	UL 508 Listed Class I, Div. 2, Groups A, B, C, D T4A Class I, Zone 2, IIC T4

Ordering data

Ordering data

Description	Type	Order No.	Pcs. / Pkt.
Analog/digital I/O module	RAD-DAIO6-IFS	2901533	1
Digital input module			
Digital relay output module			
Digital/pulse input module			
Digital transistor output module			

Type	Order No.	Pcs. / Pkt.
RAD-DAIO6-IFS	2901533	1

Type	Order No.	Pcs. / Pkt.
RAD-DI4-IFS	2901535	1

Accessories

Accessories

Analog/digital I/O module	RAD-DAIO6-IFS	2901533	1
Digital relay output module			
Digital input module			
Digital transistor output module			
Digital/pulse input module			

RAD-DAIO6-IFS	2901533	1

RAD-DOR4-IFS	2901536	1

I/O extension modules

- Easy I/O mapping via thumb wheel
- Analog inputs (0/4...20 mA) or (0...5/10 V)
- Temperature inputs for Pt 100 sensors
- Analog outputs (0/4 ... 20 mA or 0 ... 10 V)
- Easy module replacement even during operation (hot swap)
- Extended temperature range (-40°C ... +70°C)



I/O extension module,
4 analog current inputs



I/O extension module,
4 analog voltage inputs

new



Housing width 17.5 mm

Technical data

Analog input	
Number of inputs	4
Resolution	16 (Bit)
Signal range (configurable using the DIP switch)	0 mA ... 20 mA / 4 mA ... 20 mA
Accuracy	≤ 0.02 % (@25°C)
Supply voltage	≥ 12 V DC (For passive sensors (via terminal PWR1, +I1))
Analog input	
Description of the input	-
Number of inputs	-
Temperature measuring range	-
Analog output	
Number of outputs	-
Signal range	-
Accuracy	-
Load R _B	-
General data	
Supply voltage	19.2 V DC ... 30.5 V DC (TBUS)
Current consumption	≤ 120 mA (At 24 V DC, at 25°C)
Degree of protection	IP20
Ambient temperature range	-40 °C ... 70 °C
Dimensions	W / H / D 17.5 / 99 / 114.5 mm
EMC note	Class A product, see page 527
Conformance / approvals	
Conformance	CE-compliant
ATEX	Ex II 3 G Ex nA IIC T4 Gc X
IECEX	Ex nA IIC T4 Gc
UL, USA / Canada	UL 508 Listed Class I, Div. 2, Groups A, B, C, D T4A Class I, Zone 2, IIC T4

Housing width 17.5 mm

Technical data

Analog input	
Number of inputs	4
Resolution	16 (Bit)
Signal range (configurable using the DIP switch)	0 V ... 5 V / 0 V ... 10 V
Accuracy	≤ 0.1 % (@25°C)
Supply voltage	≥ 12 V DC (For passive sensors (via terminal PWR1, +U1))
Analog input	
Description of the input	-
Number of inputs	-
Temperature measuring range	-
Analog output	
Number of outputs	-
Signal range	-
Accuracy	-
Load R _B	-
General data	
Supply voltage	19.2 V DC ... 30.5 V DC (TBUS)
Current consumption	≤ 120 mA (At 24 V DC, at 25°C)
Degree of protection	IP20
Ambient temperature range	-40 °C ... 70 °C
Dimensions	W / H / D 17.5 / 99 / 114.5 mm
Conformance / approvals	
Conformance	CE-compliant
ATEX	ATEX applied for
IECEX	IECEX applied for
UL, USA / Canada	508 listing applied for

Ordering data

Description	Type	Order No.	Pcs. / Pkt.
Analog input module	RAD-AI4-IFS	2901537	1
Temperature input module			
Analog output module			

Ordering data

Description	Type	Order No.	Pcs. / Pkt.
Analog input module	RAD-AI4-U-IFS	2702290	1
Temperature input module			
Analog output module			

Accessories

Description	Type	Order No.	Pcs. / Pkt.
Analog output module	RAD-AO4-IFS	2901538	1
Analog input module			
Analog input module			
Temperature input module			

Accessories

Description	Type	Order No.	Pcs. / Pkt.
Analog output module	RAD-AO4-IFS	2901538	1
Analog input module			
Analog input module			
Temperature input module			



Temperature I/O extension module,
4 temperature inputs



I/O extension module,
4 analog current/voltage outputs

Ex:
Housing width 17.5 mm

Ex:
Housing width 17.5 mm

Technical data

Technical data

-

Pt 100 input
4
-50 °C ... 250 °C

-

-

-

19.2 V DC ... 30.5 V DC (TBUS)
≤ 38 mA (At 24 V DC, at 25°C)
IP20
-40 °C ... 70 °C
17.5 / 99 / 114.5 mm
Class A product, see page 527

-

4
0 mA ... 20 mA 0 V ... 10 V
4 mA ... 20 mA
≤ 0.02 % (@25°C) typ. 0.5 %
≤ 500 Ω ≥ 10 kΩ

19.2 V DC ... 30.5 V DC (TBUS)
≤ 115 mA (At 24 V DC, at 25°C)
IP20
-40 °C ... 70 °C
17.5 / 99 / 114.5 mm
Class A product, see page 527

CE-compliant
 II 3 G Ex nA IIC T4 Gc X
Ex nA IIC T4 Gc
UL 508 Listed
Class I, Div. 2, Groups A, B, C, D T4A
Class I, Zone 2, IIC T4

CE-compliant
 II 3 G Ex nA IIC T4 Gc X
Ex nA IIC T4 Gc
UL 508 Listed
Class I, Div. 2, Groups A, B, C, D T4A
Class I, Zone 2, IIC T4

Ordering data

Ordering data

Type	Order No.	Pcs. / Pkt.
RAD-PT100-4-IFS	2904035	1

Type	Order No.	Pcs. / Pkt.
RAD-AO4-IFS	2901538	1

Accessories

Accessories

RAD-AO4-IFS	2901538	1
-------------	---------	---

RAD-AI4-IFS	2901537	1
RAD-AI4-U-IFS	2702290	1
RAD-PT100-4-IFS	2904035	1

Wireless data communication

Wireless I/O

Bluetooth wireless modules (2.4 GHz)

Wireless MUX - the wireless signal cable

The Wireless MUX transmits 16 digital and 2 analog signals bidirectionally. The Wireless MUX is supplied ready to use: Unpack – connect – switch on – and you have a working wireless path.

– Range*:

With omnidirectional antenna, 50 m to 100 m in halls, up to 200 m outdoors.

With panel antennas, up to 400 m outdoors.

Fieldline I/O for wireless fieldbus extension

The Bluetooth I/O system integrates I/O signals into a fieldbus or an Ethernet network via Bluetooth.

Advantages of Bluetooth technology:

- Extremely robust and reliable
- Quick and easy startup
- WLAN coexistence functions AFH, LEM, black channel listing
- Parallel operation of several Bluetooth systems

Notes:

* The range may be significantly above or below that stated, and depends on the environment, antenna technology, and the product used.



Wireless set, including antennas



Technical data

Wireless interface	
Wireless standard	Bluetooth 1.2
Frequency range	2.402 GHz ... 2.48 GHz (ISM bandwidth)
Wireless modules that can be connected	-
Antenna connection method	MCX (socket)
Fieldbus interface	
Designation	-
Transmission speed	-
Power supply for module electronics	
Supply voltage	24 V DC
Supply voltage range	19.2 V DC ... 30 V DC (including ripple)
Digital inputs	
Connection technology	1-wire
Number of inputs	16
Digital outputs	
Connection technology	1-wire
Number of outputs	16
Analog inputs	
Number of inputs	2
Voltage input signal	0 V ... 10 V
Current input signal	0 mA ... 20 mA
Measured value resolution	12 bits
Analog outputs	
Number of outputs	2
Voltage output signal	0 V ... 10 V
Current output signal	0 mA ... 20 mA
DAC resolution	12 bit
General data	
Dimensions	W / H / D 95 mm / 119.8 mm / 55 mm
Degree of protection	IP20
Ambient temperature (operation)	-25 °C ... 60 °C
EMC note	

Ordering data

Description	Type	Order No.	Pcs. / Pkt.
Wireless MUX set , consisting of two modules including antennas, each with 16 digital and 2 analog inputs and outputs			
- With OMNI antennas	ILB BT ADIO MUX-OMNI	2884208	1
- With OMNI antennas, maritime approvals	ILB BT ADIO MUX-OMNI 8/M	2693185	1
- With PANEL antennas, 8 dBi antenna gain	ILB BT ADIO MUX-PANEL	2884509	1
Fieldline Modular Wireless IO base station for up to three Wireless IO devices			
- Adjustable transmission power			
Fieldline Modular wireless I/O device			
- Adjustable transmission power			
- 16 inputs			
Inline Block wireless I/O device			
- Adjustable transmission power			



Fieldline local bus base station, incl. OMNI antenna



I/O wireless module, incl. OMNI antenna



I/O wireless module, incl. OMNI antenna



Technical data

Bluetooth 1.2 2.402 GHz ... 2.48 GHz (ISM bandwidth) up to 3 (2736767 FLM BT DIO 8/8 M12, 2693208 FLM BT DI 16 M12, 2884282 ILB BT ADIO 2/2/16/16)
SMA (socket)
Fieldline Modular local bus 500 kBaud / 2 MBaud (data rate can be changed via pin 5 (voltage supply ULS))
24 V DC 19.2 V DC ... 30 V DC (including ripple)
-
-
-
-
-
-
-
-
-
-
-
70.5 mm / 178.5 mm / 50 mm IP65 -25 °C ... 60 °C Class A product, see page 527

Technical data

FLM BT DIO 8/8 M12	FLM BT DI 16 M12
Bluetooth 1.2 2.402 GHz ... 2.48 GHz (ISM bandwidth) 1 (FLM BT BS 3, FL BT MOD IO AP)	
SMA (socket)	
24 V DC 19.2 V DC ... 30 V DC (including ripple)	
2, 3-wire	2 or 3-wire (optionally 4-wire)
-	-
2, 3-wire 8 (double occupancy)	-
-	-
-	-
-	-
-	-
-	-
-	-
-	-
-	-
70.5 mm / 178.5 mm / 50 mm	70.5 mm / 178.5 mm / 68 mm
IP65 -25 °C ... 60 °C Class A product, see page 527	

Technical data

Bluetooth 1.2 2.402 GHz ... 2.48 GHz (ISM bandwidth) 1 (FLM BT BS 3, FL BT MOD IO AP)
SMA (socket)
24 V DC 19.2 V DC ... 30 V DC (including ripple)
1-wire
16
1-wire 16
2 0 V ... 10 V 0 mA ... 20 mA 12 bits
2 0 V ... 10 V 0 mA ... 20 mA 12 bit
117 mm / 119.8 mm / 73 mm IP20 -25 °C ... 60 °C Class A product, see page 527

Ordering data

Type	Order No.	Pcs. / Pkt.
FLM BT BS 3	2736770	1

Ordering data

Type	Order No.	Pcs. / Pkt.
FLM BT DIO 8/8 M12	2736767	1
FLM BT DI 16 M12	2693208	1

Ordering data

Type	Order No.	Pcs. / Pkt.
ILB BT ADIO 2/2/16/16	2884282	1

WirelessHART gateway

- The **RAD-WHG/WLAN-XD** is a WirelessHART gateway with integrated 802.11b/g WLAN transceiver. It converts HART data to Modbus/TCP for easy integration into almost any host system.
- Simple programming and diagnostics using an embedded web server or HART programmer
 - WirelessHART gateway supports 250 WirelessHART devices
 - 802.11b/g client can be used as WirelessHART backhaul connection with 802.11i (WPA2) 128-bit AES encryption
 - Fully meshed routing (self-organizing and self-healing network) with WirelessHART
 - WirelessHART uses “channel hopping” as a means of tolerating interference



WirelessHART gateway

Ex:
Housing width 45 mm

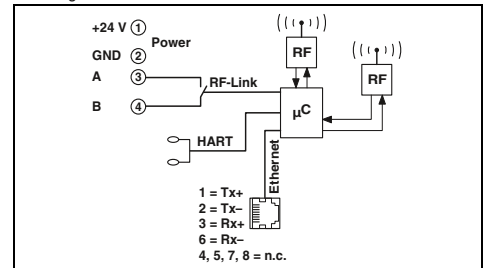

Technical data

Wireless path		
Interface description		WLAN according to IEEE 802.11 b/g
Direction		Bi-directional
Frequency range		2.4 GHz ... 2.472 GHz
Number of channels		13
Connection method		Socket
Wireless path		
Interface description		WirelessHART
Frequency range		2.4 GHz ... 2.4835 GHz
Transmission power		0 ... 10 dBm
Number of channels		15
Connection method		Socket
Ethernet interface		
Connection method		RJ45
Transmission speed		10/100 Mbps
General data		
Supply voltage		9 V DC ... 30 V DC
Current consumption	typ. / max.	125 mA (at 24 V DC) / 300 mA (at 24 V DC)
Degree of protection		IP20
Ambient temperature range		-40 °C ... 70 °C
Housing material		Polyamide PA non-reinforced
Dimensions	W / H / D	45 / 99 / 114.5 mm
Screw connection solid / stranded / AWG		0.2 ... 4 mm ² / 0.2 ... 2.5 mm ² / 24 - 14
Conformance / approvals		
Conformance		CE-compliant FCC Directive, Part 15.247 Class I, Zone 2, Group IIC; AEx nA IIC T4 Class I, Div. 2 Groups A,B,C,D Ex nA IIC T4
CSA, USA		
CSA, Canada		

Ordering data

Description	Type	Order No.	Pcs. / Pkt.
WirelessHART gateway	RAD-WHG/WLAN-XD	2900178	1

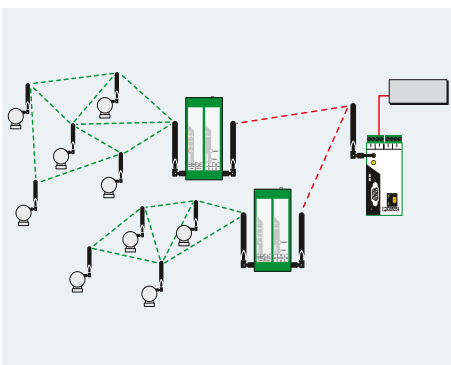

WirelessHART adapter

The **RAD-WHA-1/2NPT** is an adapter that allows up to 4 HART devices to be connected to a WirelessHART network.

- Allows wired HART devices to transfer data on a WirelessHART network
- Connect up to 4 HART device to one adapter
- Allows connection of one standard 4... 20 mA signal for easy integration of non-HART devices into a WirelessHART network
- 1/2-in. NPT fitting allows remote mounting or direct connection to instrument
- Removable antenna for connection of coaxial cable and high gain antenna

Wireless**HART**



WirelessHART adapter

Housing width 87.2 mm

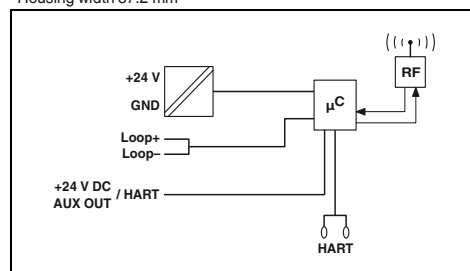

Technical data

Wireless path		WirelessHART
Interface description		Bi-directional
Direction		2.4 GHz ... 2.4835 GHz
Frequency range		15
Number of channels		N (socket)
Connection method		
Analog input		
Number of inputs		1
Signal range		4 mA ... 20 mA
General data		
Supply voltage		11 V DC ... 30 V DC
Current consumption	max.	95 mA
Degree of protection		IP67
Ambient temperature range		-40 °C ... 70 °C
Housing material		Aluminum, die-cast, corrosion resistant, powder-coated
Dimensions	W / H / D	87.2 / 161 / 65.3 mm
Connection method		Flying leads, 20 AWG

Ordering data

Description	Type	Order No.	Pcs. / Pkt.
WirelessHART adapter	RAD-WHA-1/2NPT	2900100	1

Wireless Serial

Bluetooth interface converter for RS-232, RS-422, RS-485 2-wire

Applications:

The Bluetooth converter is used as a flexible and easy replacement for cabling in order, for example, to perform programming/diagnostics tasks via a notebook or as an inexpensive alternative to slip rings, drag chains or fieldbus cables, such as Modbus, PROFIBUS, etc.

Topology:

- Point-to-point
- Multipoint with up to seven slaves

Features:

Flexible parameterization/application options:

- Can be used for RS-232/RS-422/RS-485 2-wire interfaces up to 187.5 kbps
- Transceiver for distances of up to 150 m

High transmission reliability:

- Secure and tamper-proof data transmission thanks to password protection, encryption, plus fixed and invisible device pairing
- Coexistence with other wireless systems thanks to adaptive frequency hopping (AFH) method

Easy installation:

- Wireless path diagnostics based on integrated bar graphs and 2 digital outputs
- Local configuration via USB interface without separate power supply unit

Notes:

*The range may be considerably above or below that stated. It is dependent on the environment, antenna technology, transmission power, and the product used.

The latest country registrations for the relevant product can be found on the Internet at phoenixcontact.com.

Additional Wireless Serial products can be found on page 499

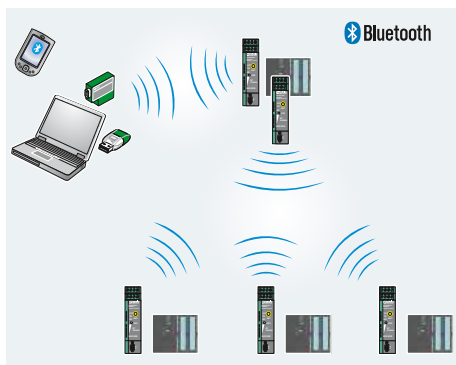

Bluetooth converter, universal for RS-232, RS-422, RS-485 2-wire



Supply	
Supply voltage	10 V DC ... 30 V DC (via plug-in COMBICON screw terminal block)
Supply voltage	19 V AC ... 29 V AC (50/60 Hz)
Supply voltage	24 V DC ±20 % (as an alternative or redundant, via backplane bus contact and system current supply)
Nominal current consumption	≤ 100 mA (24 V DC)
RS-232 interface	
Connection method	D-SUB-9 plug
Transmission speed	1.2; 2.4; 4.8; 7.2; 9.6; 19.2; 31.25; 38.4; 57.6; 75; 93.75; 115.2 kbps
RS-422 interface	
Connection method	Plug-in screw connection
Transmission speed	1.2; 2.4; 4.8; 7.2; 9.6; 19.2; 31.25; 38.4; 57.6; 75; 93.75; 115.2; 136; 187.5 kbps
RS-485 interface	
Connection method	Plug-in screw connection
Transmission speed	1.2; 2.4; 4.8; 7.2; 9.6; 19.2; 31.25; 38.4; 57.6; 75; 93.75; 115.2; 136; 187.5 kbps
Wireless interface	
Interfaces	Bluetooth 2.1 + EDR
Antenna connection	External
Receiver sensitivity	-91 dBm
Frequencies	2.402 GHz ... 2.48 GHz (ISM bandwidth)
Bluetooth Multidrop master / slave	1/7
General data	
Ambient temperature (operation)	-20 °C ... 60 °C
Electromagnetic compatibility	Conformance with R&TTE directive 1999/5/EC
Dimensions	22.5 mm / 99 mm / 116 mm

Technical data		
10 V DC ... 30 V DC (via plug-in COMBICON screw terminal block)		
19 V AC ... 29 V AC (50/60 Hz)		
24 V DC ±20 % (as an alternative or redundant, via backplane bus contact and system current supply)		
≤ 100 mA (24 V DC)		
D-SUB-9 plug		
1.2; 2.4; 4.8; 7.2; 9.6; 19.2; 31.25; 38.4; 57.6; 75; 93.75; 115.2 kbps		
RS-422 interface according to ITU-T V.11, EIA/TIA-422, DIN 66348-1		
Plug-in screw connection		
1.2; 2.4; 4.8; 7.2; 9.6; 19.2; 31.25; 38.4; 57.6; 75; 93.75; 115.2; 136; 187.5 kbps		
RS-485 interface, according to EIA/TIA-485, DIN 66259-4/RS-485 2-wire		
Plug-in screw connection		
1.2; 2.4; 4.8; 7.2; 9.6; 19.2; 31.25; 38.4; 57.6; 75; 93.75; 115.2; 136; 187.5 kbps		
Bluetooth 2.1 + EDR		
External		
-91 dBm		
2.402 GHz ... 2.48 GHz (ISM bandwidth)		
1/7		
-20 °C ... 60 °C		
Conformance with R&TTE directive 1999/5/EC		
22.5 mm / 99 mm / 116 mm		

Description
PSI Bluetooth converter, MCX connection for external antenna
- Device with 2x diagnostic outputs
- Device with HazLoc approval
PSI Bluetooth PROFIBUS-SET, supplied as standard: 2x PSI Bluetooth converters, 2x OMNI omnidirectional antennas

Ordering data		
Type	Order No.	Pcs. / Pkt.
PSI-WL-RS232-RS485/BT/2DO	2313805	1
PSI-WL-RS232-RS485/BT/HL	2313795	1

RS-232-D-SUB cable, length: 2 m
- 9-pos. socket to 9-pos. socket
Omnidirectional antenna
PANEL directional wireless antenna (without cable)
Antenna adapter cable
System power supply unit, primary-switched
DIN rail connector

Accessories		
Type	Order No.	Pcs. / Pkt.
PSM-KA9SUB9/BB/2METER	2799474	1
RAD-ISM-2400-ANT-OMNI-2-1	2867461	1
RAD-ISM-2400-ANT-PAN- 8-0	2867610	1
RAD-PIG-EF316-MCX-SMA	2867678	1
MINI-SYS-PS-100-240AC/24DC/1.5	2866983	1
ME 22.5 TBUS 1,5/ 5-ST-3,81 GN	2707437	50



Bluetooth set
Preconfigured for PROFIBUS connections

ERIC

Technical data

10 V DC ... 30 V DC (via plug-in COMBICON screw terminal block)

19 V AC ... 29 V AC (via plug-in COMBICON screw terminal block)

24 V DC $\pm 20\%$ (as an alternative or redundant, via backplane bus contact and system current supply)

≤ 100 mA (24 V DC)

-
-

RS-485 interface,
according to EIA/TIA-485, DIN 66259-4/RS-485 2-wire
COMBICON screw terminal block
Preconfigured

Bluetooth 2.1 + EDR
External
-91 dBm
2.402 GHz ... 2.48 GHz (ISM bandwidth)

-20 °C ... 60 °C
Conformance with R&TTE directive 1999/5/EC
22.5 mm / 99 mm / 116 mm

Ordering data

Type	Order No.	Pcs. / Pkt.
PSI-WL-PROFIB/BT-SET/2DO	2313876	1

Accessories

MINI-SYS-PS-100-240AC/24DC/1.5	2866983	1
ME 22,5 TBUS 1,5/ 5-ST-3,81 GN	2707437	50

Trusted Wireless Ethernet

RAD-Line Ethernet with Trusted Wireless

The industrial wireless radio **RAD-ISM-900-EN-BD...** allows a wireless connection of several decentralized controllers to a central location (controller) via an Ethernet or serial connection.

- Operates in the license-free 902-928 MHz ISM band
- Frequency-hopping spread spectrum technology
- Provides an interface for transfer of data between 900 MHz wireless and Ethernet, RS-232, RS-422 or RS-485 interfaces
- Contains an adjustable 10 mW ... 1 W transmitter
- Supports TCP/IP, UDP, and IP v4 protocols
- Programmable for point-to-point, point-to-multipoint, and multipoint-to-point configurations
- Incorporates security using selectable 128/192/256-bit AES encryption
- **RAD-ISM-900-EN-BD-BUS** features an integrated bus foot to connect I/O modules (addressable via Modbus)
- Individual modules can be configured as master, slave or repeater using integrated web browser interface
- **RAD-ISM-900-EN-BD/B** is a dedicated slave radio with no Ethernet ports

Notes:
The products are offered exclusively for export outside the European Economic Area (EEA).

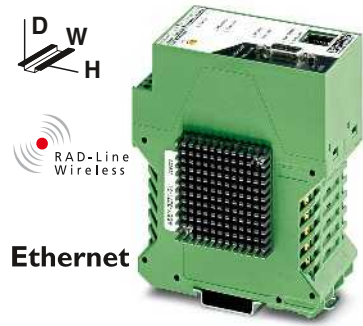

Ethernet

Wireless transceiver for Ethernet and serial interfaces (RS-232, RS-422/RS-485)

Ex: Housing width 52 mm

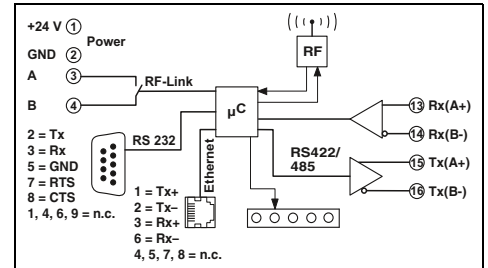

Wireless path	
Direction	Bi-directional
Frequency range	902 MHz ... 928 MHz
Transmission power	10 ... 30 dBm
Serial port	
Connection method	RS-232: D-SUB 9 (socket) RS-485: COMBICON plug-in screw terminal block
Serial transmission speed	300 ... 57.6 kbps
Data format/coding	Asynchronous
Data flow control/protocols	RTS/CTS
General data	
Supply voltage	11 V DC ... 30 V DC
Current consumption	250 mA (at 24 V DC)
Degree of protection	IP20
Ambient temperature range	-40 °C ... 65 °C
Dimensions	52 / 99 / 115 mm
Screw connection solid / stranded / AWG	0.2 ... 4 mm ² / 0.2 ... 2.5 mm ² / 24 - 14
Conformance / approvals	
Conformance	FCC Directive, Part 15.247 ISC Directive RSS 210 Class I, Div. 2, Groups A, B, C, D
UL, USA / Canada	

Technical data	
Bi-directional	
902 MHz ... 928 MHz	
10 ... 30 dBm	
RS-232	RS-485
D-SUB 9 (socket)	COMBICON plug-in screw terminal block
300 ... 57.6 kbps	
Asynchronous	
RTS/CTS	
11 V DC ... 30 V DC	
250 mA (at 24 V DC)	
IP20	
-40 °C ... 65 °C	
52 / 99 / 115 mm	
0.2 ... 4 mm ² / 0.2 ... 2.5 mm ² / 24 - 14	
FCC Directive, Part 15.247	
ISC Directive RSS 210	
Class I, Div. 2, Groups A, B, C, D	

Description
Wireless module with optional Ethernet and serial interfaces
Bus foot for I/O extension modules
Cannot be extended
Without serial ports

Ordering data		
Type	Order No.	Pcs. / Pkt.
RAD-ISM-900-EN-BD-BUS	2900017	1
RAD-ISM-900-EN-BD	2900016	1
RAD-ISM-900-EN-BD/B	2901205	1

RAD-Line Ethernet with 400 mW WLAN

- High-power Ethernet industrial wireless radio transceivers that conform to IEEE standard 802.11b/g.
- Operates in the license-free 2.4 GHz ISM band
- Features a 400 mW industrial radio transceiver
- Selectable 802.11i high security with 128/192/256-bit AES encryption and optional 802.1x authentication
- Supports UDP, and IP v4 protocols
- Individual modules can be configured as point, bridge or client modes using integrated web browser interface
- Bridge mode allows for a network of up to 40 nodes on a single network resulting in a highly reliable network
- Provides an interface for transfer of data between legacy serial devices (RS-232, RS-422, RS-485 interfaces) onto an Ethernet network
- Programmable for point-to-point, point-to-multipoint, and multipoint-to-point configurations
- Optional integrated bus foot for connection to RAD-Line extension modules
- Can be used as a Modbus RTU/TCP gateway

Notes:
The products are offered exclusively for export outside the European Economic Area (EEA).



Ethernet

WLAN wireless transceiver for Ethernet and serial interfaces (RS-232, RS-422/RS-485), can be extended with I/O extension modules

Ex: Housing width 45 mm

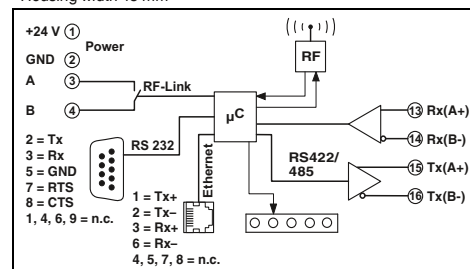

Technical data

Wireless path		Bi-directional	
Direction		2.4032 GHz ... 2.4799 GHz	
Frequency range		400 mW	
Transmission power		RS-232	RS-485/RS-422
Serial port		D-SUB 9 (socket)	COMBICON plug-in screw terminal block
Connection method		300 ... 57.6 kbps	300 ... 57.6 kbps
Serial transmission speed		Asynchronous	
Data format/coding		RTS/CTS	
Data flow control/protocols			
General data			
Supply voltage		12 V DC ... 30 V DC	
Current consumption		typ. / max. 230 mA (24 V DC) / 500 mA (12 V DC)	
Degree of protection		IP20	
Ambient temperature range		-40 °C ... 70 °C	
Dimensions		W / H / D 45 / 99 / 115 mm	
Screw connection solid / stranded / AWG		0.2 ... 4 mm ² / 0.2 ... 2.5 mm ² / 24 - 14	
Conformance / approvals			
Conformance		FCC Directive, Part 15.247 ISC Directive RSS 210 Class I, Div. 2, Groups A, B, C, D	
UL, USA / Canada			

Ordering data

Description	Type	Order No.	Pcs. / Pkt.
WLAN wireless module , high power transceiver with Ethernet and serial interface	RAD-80211-XD/HP-BUS	2900047	1
Bus foot for I/O extension modules	RAD-80211-XD/HP	2900046	1
Cannot be extended			

Extension modules

RAD-Line extension modules provide additional inputs and outputs for bi-directional Ethernet wireless systems.

- Easily installed via an integrated bus foot
- Bus provides power supply voltage
- Data transferred to transceiver module via bus
- Up to 8 modules can be connected to a single transceiver
- A maximum of 33 analog or 66 digital signals can be configured, depending on the selection of modules



Analog components for 4 inputs or 4 outputs



Digital components for 8 inputs or 8 outputs

Ex: Housing width 22.5 mm

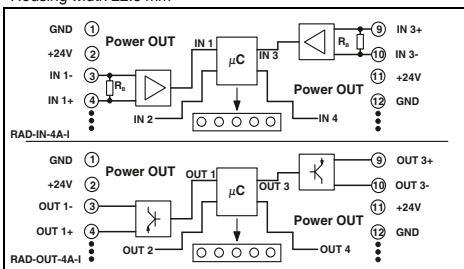

Ex: Housing width 22.5 mm

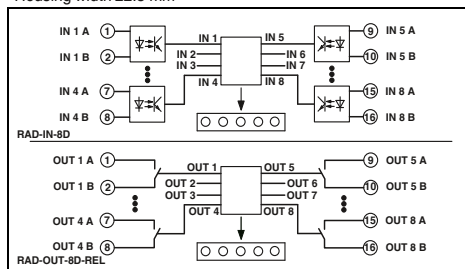

Technical data

Analog input	RAD-IN-4A-I	RAD-OUT-4A-I
Number of inputs	4	-
Signal range	4 mA ... 20 mA	-
Input resistance	< 170 Ω	-
Digital input		
Number of inputs	-	-
Signal range	-	-
Switching level	1 signal ("H") 0 signal ("L")	-
Input frequency	-	-
Pulse length	-	-
Analog output		
Number of outputs	-	4
Signal range	-	-
Load R _B	-	700 Ω (at U _B = 24 V, R _B = [U _B -10 V] / 20 mA)
Digital output		
Contact type	-	-
Switching voltage	-	-
Switching current	-	-
Clock frequency	-	-
Frequency output	-	-
General data		
Supply voltage	9 V DC ... 30 V DC (via bus foot)	9 V DC ... 30 V DC (via bus foot)
Current consumption	Typ./max. 100 mA / 130 mA	100 mA / 130 mA
Degree of protection	IP20	IP20
Ambient temperature range	-20 °C ... 65 °C	-20 °C ... 65 °C
Housing material	Polyamide PA non-reinforced	Polyamide PA non-reinforced
Dimensions	W / H / D 22.5 / 99 / 114.5 mm	22.5 / 99 / 114.5 mm
Conformance / approvals		
Conformance	CE-compliant	CE-compliant
ATEX	II 3 G EEx nL IIC	II 3 G EEx nL IIC
IECEX	Ex nL IIC	Ex nL IIC
UL, USA / Canada	Class I, Div. 2, Groups A, B, C, D	Class I, Div. 2, Groups A, B, C, D

Technical data

RAD-IN-8D	RAD-OUT-8D-REL
-	-
8	-
5 V AC/DC ... 30 V AC/DC	-
min. 5 V DC	-
Max. 1.5 V DC	-
Max. 1 Hz	-
-	-
-	8 x Relay output
-	30 V AC/DC (EC Declaration of Conformity)
-	30 V DC (with UL approval)
-	250 V AC (with UL approval)
-	0.5 A (EC Declaration of Conformity)
-	2 A (with UL approval)
-	-
-	-
9 V DC ... 30 V DC (via bus foot)	9 V DC ... 30 V DC (via bus foot)
25 mA / 30 mA	100 mA / 160 mA
IP20	IP20
-20 °C ... 65 °C	-20 °C ... 65 °C
Polyamide PA non-reinforced	Polyamide PA non-reinforced
22.5 / 99 / 114.5 mm	22.5 / 99 / 114.5 mm
CE-compliant	CE-compliant
II 3 G EEx nL IIC	II 3 G EEx nL IIC
Ex nL IIC	Ex nL IIC
Class I, Div. 2, Groups A, B, C, D	Class I, Div. 2, Groups A, B, C, D

Ordering data

Description	Type	Order No.	Pcs. / Pkt.
Extension module Analog IN	RAD-IN-4A-I	2867115	1
Extension module Analog OUT	RAD-OUT-4A-I	2867128	1
Extension module Digital IN			
Extension module Digital OUT			
Extension module Mixed I/O			

Ordering data

Type	Order No.	Pcs. / Pkt.
RAD-IN-8D	2867144	1
RAD-OUT-8D-REL	2867157	1



Analog/digital module for 2 digital inputs/outputs and 1 analog input/output



Digital module for two counter/frequency inputs



Digital module for two counter/frequency outputs

Ex: Housing width 22.5 mm

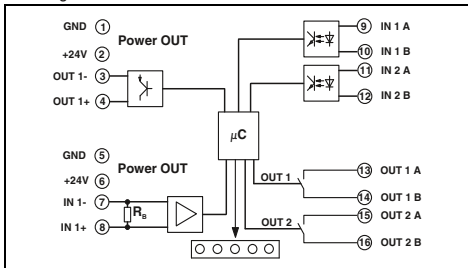

Technical data

1	4 mA ... 20 mA	< 170 Ω
2	5 V AC/DC ... 30 V AC/DC	min. 5 V DC
	Max. 1.5 V DC	
-		
1	4 mA ... 20 mA	700 Ω (at U _B = 24 V, R _B = [U _B -10 V] / 20 mA)
	2 x Relay output	30 V AC/DC (EC Declaration of Conformity)
		30 V DC (with UL approval)
		250 V AC (with UL approval)
	0.5 A (EC Declaration of Conformity)	2 A (with UL approval)
-		
-		
	9 V DC ... 30 V DC (via bus foot)	70 mA / 110 mA
		IP20
		-20 °C ... 65 °C
		Polyamide PA non-reinforced
		22.5 / 99 / 114.5 mm
	CE-compliant	II 3 G EEx nL IIC
		Ex nL IIC T5
		Class I, Div. 2, Groups A, B, C, D

Ordering data

Type	Order No.	Pcs. / Pkt.
RAD-IN+OUT-2D-1A-I	2867322	1

Ex: Housing width 22.5 mm

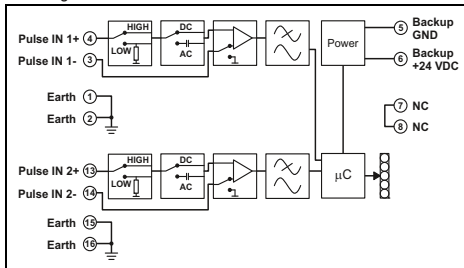

Technical data

-		
2	0.1 V AC/DC ... 30 V AC/DC	Common mode 3.6 V DC / Differential mode 100 mV _{pp}
	0.1 Hz ... 10 kHz (50 % Duty Cycle)	High time 50 µs
-		
-		
-		
-		
	9 V DC ... 30 V DC (via bus foot)	35 mA / 45 mA
		IP20
		-20 °C ... 65 °C
		Polyamide PA non-reinforced
		22.5 / 99 / 114.5 mm
	CE-compliant	II 3 G EEx nL IIC
		-
		Class I, Div. 2, Groups A, B, C, D

Ordering data

Type	Order No.	Pcs. / Pkt.
RAD-IN-2D-CNT	2885223	1

Ex: Housing width 22.5 mm

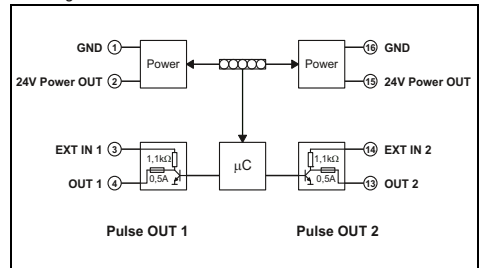

Technical data

-		
-		
-		
-		
-		
-		
-		
	9 V DC ... 30 V DC (via bus foot)	90 mA / 115 mA
		IP20
		-20 °C ... 65 °C
		Polyamide PA non-reinforced
		22.5 / 99 / 114.5 mm
	CE-compliant	II 3 G EEx nL IIC
		-
		Class I, Div. 2, Groups A, B, C, D

Ordering data

Type	Order No.	Pcs. / Pkt.
RAD-OUT-2D-CNT	2885236	1

Wireless data communication

Antennas and cables

2.4 GHz/5 GHz accessories

Omnidirectional antennas

Omnidirectional antennas to increase gain.

- Standard omnidirectional antennas



Gain 2 dBi (2.4 GHz)



Gain 2.5 dBi (2.4 GHz)/5 dBi (5 GHz)

Ambient temperature (operation)	-20 °C ... 65 °C
Degree of protection	IP65
Gain	2 dBi
Impedance	50 Ω
Connection method	MCX (pin)
Horizontal / vertical apex angle	360 ° / 75 °
Dimensions W / H	7.8 mm / 82.5 mm
Frequency range	2.4 GHz
Scope of delivery	incl. mounting material

Technical data		
Ambient temperature (operation)	-20 °C ... 65 °C	
Degree of protection	IP65	
Gain	2 dBi	
Impedance	50 Ω	
Connection method	MCX (pin)	
Horizontal / vertical apex angle	360 ° / 75 °	
Dimensions W / H	7.8 mm / 82.5 mm	
Frequency range	2.4 GHz	
Scope of delivery	incl. mounting material	

Technical data		
Ambient temperature (operation)	-40 °C ... 70 °C	
Degree of protection	IP68	
Gain	2.5 dBi (2.4 GHz) 5 dBi (5 GHz)	
Impedance	50 Ω	
Connection method	N (pin)	
Horizontal / vertical apex angle	360 ° / 30 ° (At 2.4 GHz) 360 ° / 16 ° (At 5 GHz)	
Dimensions W / H	23 mm / 180 mm	
Frequency range	2.4 GHz ... 2.5 GHz / 5.15 GHz ... 5.83 GHz	
Scope of delivery	-	

Description
Omnidirectional antenna
With connection MCX (pin)
With connection RSMA (pin)
With N connection (pin)

Ordering data		
Type	Order No.	Pcs. / Pkt.
RAD-ISM-2400-ANT-OMNI-2-1	2867461	1
RAD-ISM-2400-ANT-OMNI-2-1-RSMA	2701362	1

Ordering data		
Type	Order No.	Pcs. / Pkt.
ANT-OMNI-2459-02	2701408	1

2.4 GHz/5 GHz accessories

Omnidirectional antennas

Omnidirectional antennas to increase gain.

- With vandalism protection thanks to increased impact strength



Gain 3 dBi (2.4 GHz)



Dual band, gain up to 6 dBi (2.4 GHz)/ up to 8 dBi (5 GHz)

Ambient temperature (operation)	-40 °C ... 80 °C
Degree of protection	IP55
Gain	3 dBi
Impedance	50 Ω
Connection method	MCX (pin)
Horizontal / vertical apex angle	360 ° / 85 °
Dimensions W / H	86 mm / 43 mm
Frequency range	2.4 GHz

Technical data		
Ambient temperature (operation)	-40 °C ... 80 °C	
Degree of protection	IP55	
Gain	3 dBi	
Impedance	50 Ω	
Connection method	MCX (pin)	
Horizontal / vertical apex angle	360 ° / 85 °	
Dimensions W / H	86 mm / 43 mm	
Frequency range	2.4 GHz	

Technical data		
Ambient temperature (operation)	-40 °C ... 80 °C	
Degree of protection	IP68	
Gain	6 dBi (2.4 GHz, when mounted on metal surface) 8 dBi (5.6 GHz, when mounted on metal surface)	
Impedance	50 Ω	
Connection method	N (socket)	
Horizontal / vertical apex angle	360 ° / -	
Dimensions W / H	92 mm / 51 mm	
Frequency range	2.4 GHz / 5.15 GHz ... 5.83 GHz	

Description
OMNI omnidirectional antenna with vandalism protection
With connection MCX (pin)
With connection RSMA (pin)
With SMA connection (pin)
With adapter cable N (pin) -> SMA (pin)
Mounting material for wall mounting

Ordering data		
Type	Order No.	Pcs. / Pkt.
RAD-ISM-2400-ANT-VAN-3-1-MCX	2885702	1
RAD-ISM-2400-ANT-VAN-3-0-RSMA	2701358	1
RAD-ISM-2400-ANT-VAN-3-0-SMA	2885867	1
RAD-ANT-VAN-MKT	2885870	1

Ordering data		
Type	Order No.	Pcs. / Pkt.
RAD-ISM-2459-ANT-FOOD-6-0	2692526	1

2.4 GHz/5 GHz accessories

Omnidirectional antennas

Omnidirectional antennas to increase gain.

- High-quality omnidirectional antennas for wall and mast mounting



Gain 6 dBi (2.4 GHz)



Gain 5 dBi (5 GHz)

Ambient temperature (operation)
Degree of protection
Gain
Impedance
Connection method
Horizontal / vertical apex angle
Dimensions W / H
Frequency range
Scope of delivery

-40 °C ... 75 °C
IP55
6 dBi
50 Ω
N (socket)
360 ° / 30 °
22 mm / 250 mm
2.4 GHz ... 2.5 GHz
incl. mounting material

Technical data

-45 °C ... 70 °C
IP64
5 dBi
50 Ω
N (socket)
360 ° / 25 °
16 mm / 130 mm
5.15 GHz ... 5.875 GHz
incl. mounting material

Technical data

Ordering data

Type	Order No.	Pcs. / Pkt.
RAD-ISM-2400-ANT-OMNI-6-0	2885919	1
RAD-2400-ANT-OMNI-6-0-SW	2903219	1

Ordering data

Type	Order No.	Pcs. / Pkt.
ANT-OMNI-5900-01	2701347	1

Description

Omnidirectional antenna
With connection N (socket)
With connection N (socket), salt water resistant

2.4 GHz/5 GHz accessories

Directional wireless antennas

Directional wireless antennas with high gain for transmission over longer distances.

- Linear polarized
- For wall or mast mounting



Dual band, gain up to 9 dBi (2.4/5 GHz)



with 2 radiators, gain 9 dBi (5 GHz)

Ambient temperature (operation)
Degree of protection
Gain
Impedance
Connection method
Horizontal / vertical apex angle
Dimensions W / H
Frequency range
Scope of delivery

ANT-DIR-2459-01	RAD-ISM-2400-ANT-PAN- 8-0
-40 °C ... 75 °C	-40 °C ... 75 °C
IP67	IP55
9 dBi	8 dBi
50 Ω	50 Ω
N (socket)	SMA (socket)
75 ° / 55 ° (At 2.4 GHz)	75 ° / 70 °
55 ° / 55 ° (At 5 GHz)	-
80 mm / 101 mm	80 mm / 100 mm
2.4 GHz ... 2.5 GHz / 5.15 GHz ... 5.875 GHz	2.3 GHz ... 2.8 GHz
incl. mounting material	incl. mounting material

Technical data

Technical data

-40 °C ... 80 °C
IP67
9 dBi
50 Ω
N (socket)
70 ° / 60 ° (At 5 GHz)
80 mm / 101 mm
5.15 GHz ... 5.875 GHz
incl. mounting material

Ordering data

Type	Order No.	Pcs. / Pkt.
ANT-DIR-2459-01	2701186	1
RAD-ISM-2400-ANT-PAN- 8-0	2867610	1

Ordering data

Type	Order No.	Pcs. / Pkt.
ANT-DIR-5900-01	2701348	1

Description

PANEL directional wireless antenna (without cable)
With connection N (socket)
With connection SMA (socket)

Wireless data communication

Antennas and cables

2.4 GHz/5 GHz accessories

Directional wireless antennas, linear polarized

– For large distances with line of sight



Gain: 19 dBi (2.4 GHz)



Gain: 18 dBi or 22 dBi (5 GHz)

Ambient temperature (operation)
Degree of protection
Gain
Impedance
Horizontal / vertical apex angle
Dimensions W / H
Frequency range
Scope of delivery

Technical data	
Ambient temperature (operation)	-40 °C ... 70 °C
Degree of protection	IP65
Gain	19 dBi
Impedance	50 Ω
Horizontal / vertical apex angle	17 ° / 11 °
Dimensions W / H	610 mm / 419 mm
Frequency range	2.4 GHz
Scope of delivery	incl. mounting material

Technical data	
RAD-ISM-5000-ANT-PAR-18-N	RAD-ISM-5000-ANT-PAR-22-N
-40 °C ... 70 °C	-40 °C ... 70 °C
IP55	IP55
18 dBi	22 dBi
50 Ω	50 Ω
18 ° / 18 °	12 ° / 12 °
152.4 mm / 152.4 mm	304.8 mm / 304.8 mm
5.25 GHz ... 5.85 GHz	5.25 GHz ... 5.85 GHz
incl. mounting material	incl. mounting material

Description
Parabolic antenna With connection N (socket)
Parabolic antenna Gain 18 dBi
Gain 22 dBi

Ordering data		
Type	Order No.	Pcs. / Pkt.
RAD-ISM-2400-ANT-PAR-19-0	2867885	1

Ordering data		
Type	Order No.	Pcs. / Pkt.
RAD-ISM-5000-ANT-PAR-18-N	5606613	1
RAD-ISM-5000-ANT-PAR-22-N	5606174	1

868 MHz/900 MHz accessories

Omnidirectional antennas

– High-quality omnidirectional antennas for wall and mast mounting

Directional wireless antennas

– For wall or mast mounting



Omnidirectional/directional antenna, up to 4 dBi gain (868 MHz)



Yagi directional antenna, up to 12 dBi gain (868/900 MHz)

Ambient temperature (operation)
Degree of protection
Gain
Impedance
Connection method
Horizontal / vertical apex angle
Dimensions W / H
Frequency range
Scope of delivery

Technical data	
ANT-OMNI-868-01	ANT-DIR-868-01
-40 °C ... 75 °C	-40 °C ... 75 °C
IP67	IP67
4 dBi	3.5 dBi
50 Ω	50 Ω
N (socket)	N (socket)
360 ° / 30 °	135 ° / 90 °
20 mm / 620 mm 20 mm	80 mm / 101 mm
868 MHz ... 870 MHz	865 MHz ... 870 MHz
incl. mounting material	incl. mounting material

Technical data	
RAD-ISM-900-ANT-YAGI-6.5-N	RAD-ISM-900-ANT-YAGI-10-N
-40 °C ... 80 °C	-40 °C ... 80 °C
IP65	IP65
8.5 dBi	12.15 dBi
50 Ω	50 Ω
N (socket) with cable (0.6 m)	N (socket) with cable (0.6 m)
100 ° / 62 °	56 ° / 46 ° (-3 dB)
60.5 mm / 172 mm	60.5 mm / 172 mm
868 MHz ... 960 MHz	868 MHz ... 960 MHz
incl. mounting material	incl. mounting material

Description
Omnidirectional antenna
PANEL directional wireless antenna (without cable)
Directional wireless antenna

Ordering data		
Type	Order No.	Pcs. / Pkt.
ANT-OMNI-868-01	2702136	1
ANT-DIR-868-01	2702137	1

Ordering data		
Type	Order No.	Pcs. / Pkt.
RAD-ISM-900-ANT-YAGI-6.5-N	2867814	1
RAD-ISM-900-ANT-YAGI-10-N	5606614	1

Antenna cable

- Various cables for connection of different antennas
- Frequency range: 900 MHz ... 5 GHz



Antenna adapter cable,
N (pin) -> RSMA (pin)



Antenna extension cable

General data	Technical data			Technical data		
	Ambient temperature range	-40 °C ... 85 °C			-40 °C ... 105 °C	
Impedance	50 Ω			50 Ω		
Description	Ordering data			Ordering data		
	Type	Order No.	Pcs. / Pkt.	Type	Order No.	Pcs. / Pkt.
Antenna adapter cable						
0.5 m long	RAD-PIG-RSMA/N-0.5	2903263	1			
1 m long	RAD-PIG-RSMA/N-1	2903264	1			
2 m long	RAD-PIG-RSMA/N-2	2903265	1			
3 m long	RAD-PIG-RSMA/N-3	2903266	1			
5 m long	RAD-PIG-RSMA/N-5	2702140	1			
Antenna extension cable						
3 m long, N connection at both ends (pin)				RAD-CAB-EF393- 3M	2867649	1
5 m long, N connection at both ends (pin)				RAD-CAB-EF393- 5M	2867652	1
10 m long, N connection at both ends (pin)				RAD-CAB-EF393-10M	2867665	1
15 m long, N connection at both ends (pin)				RAD-CAB-EF393-15M	2885634	1
3 m long, SMA connection at both ends (pin)				RAD-CAB-EF142-3M	2884512	1
5 m long, SMA connection at both ends (pin)				RAD-CAB-EF142-5M	2884525	1

Accessories

Adapter/extension cables

- Extension or adaptation of wireless module for antenna
- Frequency range: 900 MHz ... 5 GHz



Antenna adapter cable



Panel feed-through

General data	Technical data			Technical data		
	Ambient temperature range	-40 °C ... 70 °C			-40 °C ... 70 °C	
Impedance	50 Ω			50 Ω		
Description	Ordering data			Ordering data		
	Type	Order No.	Pcs. / Pkt.	Type	Order No.	Pcs. / Pkt.
Antenna adapter cable						
1 m long, MCX (pin) -> SMA (pin)	RAD-PIG-EF316-MCX-SMA	2867678	1			
50 cm long, MCX (pin) -> N (pin)	RAD-PIG-EF316-MCX-N	2867681	1			
30 cm long, N (socket) -> SMA (pin)	RAD-PIG-EF316-N-SMA	2867694	1			
50 cm long, N (pin) -> N (pin)	FL LCX PIG-EF142-N-N	2700677	1			
Antenna adapter cable						
50 cm long, N (socket) -> RSMA (pin)				RAD-PIG-EF316-N-RSMA	2701402	1

Wireless data communication

Antennas and cables

Accessories

Surge protection

- For installing the antenna outside buildings from a cable length of 3 m



Antenna surge protection



Protection adapter for coaxial cables

General data	
Ambient temperature range	-40 °C ... 90 °C
Degree of protection	IP68
Attenuation	typ. 0.05 dB (≤ 0.15 dB)
Frequency range	2.4 GHz ... 5.9 GHz

Technical data	
CN-LAMBDA/4-5.9...	CN-LAMBDA/4-2.2...
-40 °C ... 90 °C	-40 °C ... 90 °C
IP68	IP68
typ. 0.05 dB (≤ 0.15 dB)	typ. 0.05 dB (≤ 0.15 dB)
2.4 GHz ... 5.9 GHz	0.82 GHz ... 2.2 GHz

Technical data	
-40 °C ... 90 °C	IP68
0.1 dB (6 GHz)	0 Hz ... 6 GHz

Ordering data	
Description	COAXTRAB, protection adapter for antenna connections with Lambda/4 technology, 2.4 to 5.9 GHz
Socket-socket	
Plug-socket	
Socket-socket	
Plug-socket	
Description	COAXTRAB, protection adapter for coaxial cable systems, DC to 6 GHz
Socket-socket	
Plug-socket	

Ordering data		
Type	Order No.	Pcs. / Pkt.
CN-LAMBDA/4-5.9-BB	2838490	1
CN-LAMBDA/4-5.9-SB	2800023	1
CN-LAMBDA/4-2.2-BB	2800024	1
CN-LAMBDA/4-2.2-SB	2800025	1

Ordering data		
Type	Order No.	Pcs. / Pkt.
CN-UB-70DC-6-BB	2803166	1
CN-UB-70DC-6-SB	2803153	1

Adapter

- For installing the antenna inside buildings

Sealing tape

- Provides additional weather protection for adapters, splitters, cable connections, etc.
- Self-vulcanizing



Adapter



Sealing tape

General data	
Ambient temperature range	-65 °C ... 165 °C
Degree of protection	IP20
Impedance	50 Ω
Features	-
Width	-
Length	-
Thickness	-

Technical data	
-65 °C ... 165 °C	IP20
50 Ω	-
-	Self-vulcanizing
-	19 mm
-	3 m
-	0.75 mm

Technical data	
-40 °C ... 90 °C	-
-	Self-vulcanizing
-	19 mm
-	3 m
-	0.75 mm

Ordering data	
Description	Adapter
N (socket) -> N (socket)	
N (pin) -> SMA (socket)	
RSMA (socket) -> SMA (socket)	
SMA (socket) -> SMA (socket)	
SMA (socket) -> SMA (socket), perpendicular	
Description	Weather protection tape

Ordering data		
Type	Order No.	Pcs. / Pkt.
RAD-ADP-N/F-N/F	2867843	1
RAD-ADP-N/M-SMA/F	2917036	1
RAD-ADP-RSMA/F-SMA/F	2884538	1
RAD-ADP-SMA/F-SMA/F	2884541	1
RAD-ADP-SMA/F-SMA/M-90	2917324	1

Ordering data		
Type	Order No.	Pcs. / Pkt.
RAD-TAPE-SV-19-3	2903182	1

new

Accessories

Antenna barrier

– For the safe use of standard antennas in the hazardous area

The antenna barrier limits the ignition energy at the antenna connection in an intrinsically safe way according to protection type Ex i. Standard antennas can therefore be used up to Ex zone 0.

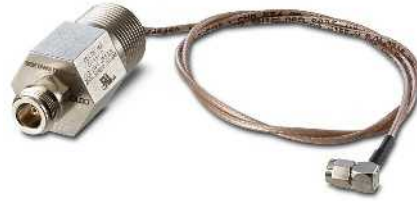

Antenna barrier for installation in Ex zone 1



Antenna barrier for installation in Ex zone 2

General data
Ambient temperature range
Degree of protection
Frequency range
Conformance / approvals
ATEX
IECEX

Technical data		
-40 °C ... 75 °C		
IP66		
25 MHz ... 6000 MHz		
II 2(1)G, Ex d mb [ia] IIC		
-		

Description
Antenna barrier
76 cm long, N (socket) -> RSMA (pin)
N (socket) -> N (socket)

Ordering data			
Type	Order No.	Pcs. / Pkt.	
RAD-PIG-RSMA-N-EX/ATEX	2904788	1	

Technical data		
-40 °C ... 75 °C		
IP65		
700 MHz ... 6000 MHz		
-		
IECEX applied for		

Ordering data			
Type	Order No.	Pcs. / Pkt.	
BAR-ANT-N-N-EX	2702198	1	

Accessories

Antenna splitter

- For splitting HF signals between two antennas
- For connecting two panel antennas for repeater applications
- Use the FL LCX PIG-EF142-N-N antenna cable to connect two directional antennas



Antenna splitter

General data
Ambient temperature range
Degree of protection
Frequency range

Technical data		
-40 °C ... 100 °C		
IP65, when installed		
0 Hz ... 11 GHz		

Description
Antenna splitter
Antenna cable
1 m long, N (pin) -> N (pin)

Ordering data			
Type	Order No.	Pcs. / Pkt.	
RAD-SPL-2-N/N	2702293	1	
FL LCX PIG-EF142-N-N	2700677	1	

Wireless data communication

Antennas and cables

Leaky wave cable and accessories

The leaky wave cable is a cable that acts as an antenna, which emits continuously along its length. It ensures a continuous wireless connection when using track-guided systems, even in angled or difficult to reach spaces.



Leaky wave conductor



Planing tool and cable tie

Ambient temperature (operation)
Impedance
Cable, attenuation
Connection method
Frequency range

Technical data
-40 °C ... 85 °C
50 Ω
19.8 dB/100 m, longitudinal attenuation (2.4 GHz)
Open end
2.4 GHz ... 2.6 GHz

Technical data
-
-
-
-

Description

Leaky wave cable

Connectors for leaky wave cables

Antenna cable

50 cm long, N (pin) -> N (pin)

Termination resistors for leaky wave cables

N (pin)

Alignment tool for leaky wave cables

Cable tie for leaky wave cables

Ordering data		
Type	Order No.	Pcs. / Pkt.
FL LCX CABLE METER	2884774	1
FL LCX CON-N/F	2884965	1
FL LCX PIG-EF142-N-N	2700677	1
FL LCX 50-OHM	2884978	1

Ordering data		
Type	Order No.	Pcs. / Pkt.
FL LCX TOOL	2884981	1
FL LCX CLAMP	2884994	100

Control box sets

Control box set for the FL WLAN 5100 access point for use directly in industrial environments or in protected outdoor areas.

Features:

- IP66 control box
- Mounting suitable for industrial use
- Bore holes, screw connections already included
- Various sets, suitable for the most common applications



General data
Width
Height
Depth

Technical data
174 mm
254 mm
137 mm

Description
Control cabinet set, IP66, including DIN rail, plugs, and screw connections
- With 3 omnidirectional antennas and antenna cables
- With 3 omnidirectional antennas, antenna cables, and 100 ... 240 V AC power supply
- With one panel antenna, antenna cable, and 100 ... 240 V AC power supply

Ordering data		
Type	Order No.	Pcs. / Pkt.
FL robust BOX	2701204	1
FL robust BOX OMNI-1	2701430	1
FL robust BOX OMNI-2	2701439	1
FL robust BOX DIR-1	2701440	1

Set for mast mounting of the FL robust BOX housing, including screw clamps for masts up to 89 mm in diameter

Accessories		
Type	Order No.	Pcs. / Pkt.
FL robust BOX POLE SET	2701205	1

900 MHz accessories

Omnidirectional antennas

- Mobile or stationary applications
- Point-to-multipoint configurations
- Small antennas are suitable for applications with a shorter range
- Large antennas are suitable for applications with a longer range



2.15 dBi/7 dBi gain



5 dBi/8 dBi gain

Technical data		
RAD-ISM-900-ANT-OMNI-0-6	RAD-ISM-900-ANT-OMNI-5	
Ambient temperature (operation)	-40 °C ... 75 °C	-40 °C ... 80 °C
Degree of protection	IP65	IP65
Gain	2.15 dBi	7 dBi
Impedance	50 Ω	50 Ω
Connection method	MCX (pin)	N (socket)
Horizontal / vertical apex angle	360 ° / N/A	360 ° / 30 °
Dimensions W / H	0.3 cm / 8.9 cm	0.3 cm / 60.9 cm
Frequency range	900 MHz	900 MHz
Scope of delivery	incl. mounting material	incl. mounting material

Technical data		
RAD-ISM-900-ANT-OMNI-FG-3-N	RAD-ISM-900-ANT-OMNI-FG-6-N	
Ambient temperature (operation)	-40 °C ... 80 °C	-40 °C ... 80 °C
Degree of protection	IP65	IP65
Gain	5.15 dBi	8 dBi
Impedance	50 Ω	50 Ω
Connection method	N (socket)	N (socket)
Horizontal / vertical apex angle	360 ° / 28 °	360 ° / 15 °
Dimensions W / H	2.38 in. / 44.25 in.	6.05 cm / 180.34 cm
Frequency range	902 MHz ... 928 MHz	900 MHz
Scope of delivery	incl. mounting material	incl. mounting material

Ordering data		
Type	Order No.	Pcs. / Pkt.
RAD-ISM-900-ANT-OMNI-0-6	2867160	1
RAD-ISM-900-ANT-OMNI-5	2867199	1

Ordering data		
Type	Order No.	Pcs. / Pkt.
RAD-ISM-900-ANT-OMNI-FG-3-N	2867791	1
RAD-ISM-900-ANT-OMNI-FG-6-N	2885579	1

Description
Omnidirectional antenna

900 MHz accessories

Directional wireless antennas (YAGI)

- Stationary applications
- Point-to-point configurations for line of sight



5 dBi gain, with 0.6 m connecting cable



8.5 dBi/12 dBi gain, with 0.6 m connecting cable

Technical data		
RAD-ISM-900-ANT-YAGI-3-N	RAD-ISM-900-ANT-YAGI-10-N	
Ambient temperature (operation)	-40 °C ... 80 °C	-40 °C ... 80 °C
Degree of protection	IP65	IP65
Gain	5 dBi	12.15 dBi
Impedance	50 Ω	50 Ω
Connection method	N (socket) with cable (0.6 m)	N (socket) with cable (0.6 m)
Horizontal / vertical apex angle	168 ° / 78 °	56 ° / 46 ° (-3 dB)
Dimensions W / H	6 cm / 17 cm	60.5 mm / 172 mm
Frequency range	900 MHz	868 MHz ... 960 MHz
Scope of delivery	incl. mounting material	incl. mounting material

Technical data		
RAD-ISM-900-ANT-YAGI-6.5-N	RAD-ISM-900-ANT-YAGI-10-N	
Ambient temperature (operation)	-40 °C ... 80 °C	-40 °C ... 80 °C
Degree of protection	IP65	IP65
Gain	8.5 dBi	12.15 dBi
Impedance	50 Ω	50 Ω
Connection method	N (socket) with cable (0.6 m)	N (socket) with cable (0.6 m)
Horizontal / vertical apex angle	100 ° / 62 °	56 ° / 46 ° (-3 dB)
Dimensions W / H	60.5 mm / 172 mm	60.5 mm / 172 mm
Frequency range	868 MHz ... 960 MHz	868 MHz ... 960 MHz
Scope of delivery	incl. mounting material	incl. mounting material

Ordering data		
Type	Order No.	Pcs. / Pkt.
RAD-ISM-900-ANT-YAGI-3-N	2867801	1

Ordering data		
Type	Order No.	Pcs. / Pkt.
RAD-ISM-900-ANT-YAGI-6.5-N	2867814	1
RAD-ISM-900-ANT-YAGI-10-N	5606614	1

Description
Directional wireless antenna

Wireless data communication

Antennas and cables

Antenna cable

- Various cables for connection of different antennas
- Frequency range: 900 MHz ... 5 GHz



Antenna adapter cable,
N (pin) -> RSMA (pin)

General data
Ambient temperature range
Impedance

Technical data

-40 °C ... 85 °C
50 Ω

Description
Antenna adapter cable
0.5 m long
1 m long
2 m long
3 m long
5 m long

Ordering data

Type	Order No.	Pcs. / Pkt.
RAD-PIG-RSMA/N-0.5	2903263	1
RAD-PIG-RSMA/N-1	2903264	1
RAD-PIG-RSMA/N-2	2903265	1
RAD-PIG-RSMA/N-3	2903266	1
RAD-PIG-RSMA/N-5	2702140	1

Antenna cable

- Various cables for connection of different antennas
- Frequency range: 900 MHz ... 5 GHz



General data
Ambient temperature range
Attenuation
Impedance
Conformance / approvals
UL, USA / Canada

Technical data

-40 °C ... 75 °C
0.89 dB/m
50 Ω

Technical data

-40 °C ... 75 °C
0.6 dB @ 900 MHz
50 Ω

Class I, Div. 1, 2, Groups A, B, C, D
Class II, Div. 1, 2, Groups F, G

Description
Antenna adapter cable
1.2 m long, MCX (pin) -> N (socket)
1.2 m long, 90° MCX (pin) -> N (socket)
1.2 m long, SMA (pin) -> N (socket)
30 cm long, MCX (pin) -> MCX (pin)
Antenna adapter cable for Ex-zone 1
90 cm long, MCX (pin) -> RPSMA (pin)

Ordering data

Type	Order No.	Pcs. / Pkt.
RAD-CON-MCX-N-SB	2867717	1
RAD-CON-MCX90-N-SS	2885207	1
RAD-CON-SMA-N-SS	2867403	1
RAD-CON-MCX-MCX-SS	2867607	1

Ordering data

Type	Order No.	Pcs. / Pkt.
RAD-CON-MCX-RPSMA-EX	2885621	1

Extension cable

- Various cables to extend distance between the radio and antenna



Antenna extension cable, N (pin)

General data	
Ambient temperature range	-40 °C ... 85 °C
Impedance	50 Ω

Technical data

Ordering data

Description
Antenna extension cable, N connection at both ends (pin)
3 m long, attenuation (at 900 MHz) 0.96 dB
6 m long, attenuation (at 900 MHz) 0.98 dB
7.5 m long, attenuation (at 900 MHz) 1 dB
12 m long, attenuation (at 900 MHz) 0.25 dB/m
15 m long, attenuation (at 900 MHz) 0.25 dB/m
18 m long, attenuation (at 900 MHz) 0.13 dB/m
24 m long, attenuation (at 900 MHz) 0.13 dB/m
30 m long, attenuation (at 900 MHz) 0.13 dB/m
45 m long, attenuation (at 900 MHz) 0.08 dB/m
60 m long, attenuation (at 900 MHz) 0.06 dB/m

Type	Order No.	Pcs. / Pkt.
RAD-CAB-LMR240-10	5606124	1
RAD-CAB-LMR400-20	5606125	1
RAD-CAB-LMR500-25	5606126	1
RAD-CAB-RG213-40	2867377	1
RAD-CAB-RG213-50	2867225	1
RAD-CAB-LMR400-60	2867380	1
RAD-CAB-LMR400-80	2867393	1
RAD-CAB-LMR400-100	2867238	1
RAD-CAB-LMR600-150	2885184	1
RAD-CAB-LMR900-200	2885197	1

Control cabinet/switch box

- For antennas with extension cable, with surge protection

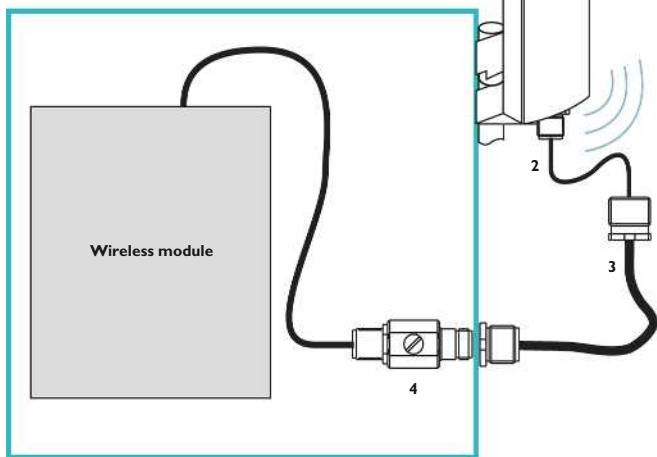

- 1 Antenna
- 2 Antenna adapter cable (pigtail)
- 3 Antenna extension cable
- 4 Surge protection

Control cabinet/switch box

- For antennas without extension cable, without surge protection

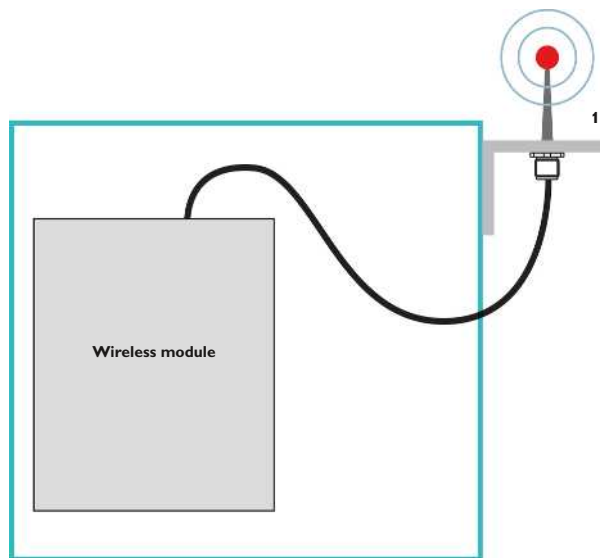

Quality in quantity

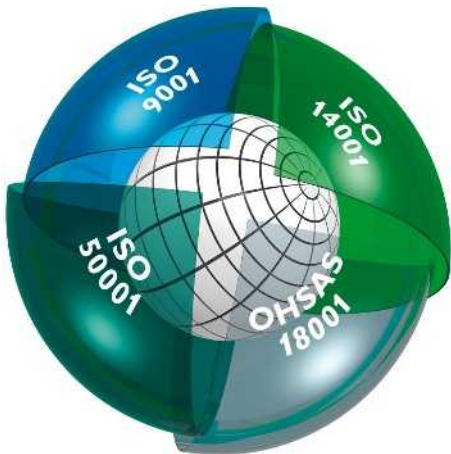

Integrated management system

The aim of the Phoenix Contact integrated management system is to coordinate all the requirements regarding products, processes, and organization.

Statutory and regulatory requirements, as well as those of international standards and our customers, are met and, in some cases, even exceeded in all phases of the product lifecycle.

The Phoenix Contact management system is monitored by internationally recognized independent bodies each year to ensure that quality, environmental protection, energy efficiency, and occupational safety have been integrated in conformance with the relevant requirements. Certification in accordance with international standards ISO 9001, ISO 14001, ISO 50001, and BS OHSAS 18001 is the result of our corporate philosophy of meeting the needs of our customers, staff, and environment as best as possible. They serve as the basis for innovative products with the familiar high Phoenix quality standard, actively practiced environmental protection through efficient production and products that conserve resources, and responsibility in the field of occupational health and safety. It goes without saying that we integrate all further requirements of standards, international approvals or special customer requirements into our company processes.

This system provides a building block for the success of the Phoenix Contact Group and its products and services.

CE marking

CE marking was introduced as an important instrument for the free movement of goods and services within the single European market. By attaching the mark to a product, the manufacturer confirms that it complies with all applicable European Union (EU) directives. EC directives describe the product properties with regard to device safety and avoiding danger. These are legally binding regulations of the European Union (EU). In other words, compliance with the requirements is a **statutory condition for marketing the product within the EU.**

Where applicable, the products that our company currently manufactures fall within the scope of the following directives:

- 2006/95/EC and 2014/35/EU
Electrical equipment designed for use with in certain voltage limits (Low-Voltage Directive)
- 2004/108/EC and 2014/30/EU
Electromagnetic compatibility (EMC Directive)
- 2004/22/EC and 2014/32/EU
Measuring instruments
- 2006/42/EC
Safety of machinery (Machinery Directive)
- 94/9/EC and 2014/34/EU
Equipment and protective systems intended for use in potentially explosive areas (ATEX Directive)
- 1999/5/EC
R&TTE Directive and 2014/53/EU
Radio Equipment Directive

The standards upon which the specified directives are based have been part of our standard of development for a long time. This guarantees conformance with European directives. The numbers of the directives indicate their version at the time of publication.

In the event of changes to directives and/or standards, our products will undergo conformity assessment again in good time and a new declaration of conformity will be issued promptly. The current declarations for each product can also be found in our download area.

The EMC Directive occupies a special place among the European directives listed. It defines electromagnetic compatibility as a fundamental property of devices based on mandatory guidelines. European Law therefore acknowledges the electromagnetic compatibility of devices and systems as an important condition for error-free operation of machinery and systems. Phoenix Contact is one of the leading international companies in surge protection, and therefore possesses broad expertise in EMC. This expertise and the experience

gained over years of developing and applying industrial interface and communication technology have resulted in our products having an extremely high standard of quality with regard to electromagnetic compatibility. It was with a view to providing other companies with this expertise that our associate company, Phoenix Testlab, was founded. Phoenix Testlab GmbH is an independent, accredited service provider offering EMC testing that conforms to European standards. At Phoenix Testlab, devices are also tested with regard to their electrical safety, mechanical influences, and their behavior in relation to environmental influences. Furthermore, Phoenix Testlab is a “Notified Body” in accordance with EMC Directive 2004/108/EC and according to

R&TTE Directive 1999/5/EC for radio and telecommunications terminal equipment. As a “Telecom Certification Body” (TCB), Phoenix Testlab may also approve these products for markets in the USA, Canada, and Japan.

Standards and regulations

All relevant standards and regulations are used as the basis for the development and maintenance of our products.

International standards are subject to continuous changes as a result of harmonization and new developments. In line with this process, the current version of all standards that are relevant to our products is documented in the product area on our website at www.phoenixcontact.net/products.

Online product information service on the web

Phoenix Contact's product range is growing constantly.

Due to our commitment to product monitoring, all products are subject to improvement.

The Internet is an ideal platform to quickly communicate new product developments and improvements to the market.

You can quickly access the relevant Phoenix Contact website for your region via www.phoenixcontact.com. Here, you will always find the latest overview of products, solutions, and services from Phoenix Contact. This includes technical documents, such as data sheets and user manuals, the latest driver and demo software, plus a means of contacting the appropriate contact person directly.

Shock protection

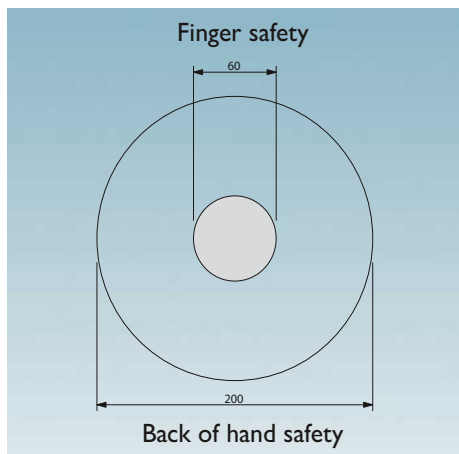

Example: pressure actuation



Finger safety



Back of hand safety

The accident prevention regulations BGV A 2 issued by the German employer's liability insurance association for precision mechanics and electrical engineering apply to the operators of electrical systems and are aimed at the prevention of electrical accidents by means of special safety requirements.

These regulations contain specifications regarding the safety distances for work, operation, and occasional handling in the proximity of "live parts" in low-voltage systems up to 1000 V ~ or 1500 V –.

- Work with live parts is only permitted once they have been de-energized. Operational activities are only permitted in the vicinity of live parts if these parts are de-energized or are protected against direct contact (§ 6). The following safety measures apply when working in the vicinity of live parts:
- Provision of the de-energized state for the duration of the work
- Ensure shock protection is in place in the form of covers or barriers during the work
- Assurance that the permitted proximity limits will not be violated (§ 7).

The term "occasional handling" has been introduced for the operation of elements such as pushbuttons, rocker arms or rotary buttons in the proximity of live parts.

According to VDE 0105-1, this is covered by "operation with partial protection against direct contact".

Detailed specifications for "occasional handling" can be found in DIN VDE 0106-100. This specifies to what degree live parts in the proximity of operating elements are to be protected against contact. The basis for this is the definition of a "protection area for occasional handling"; this is the area into which the user must reach in order to handle the machine.

The most important thing is that an area formed by an even envelope curve 30 mm in radius must surround the live parts. This area must be **touch proof**, i.e., the live parts of the electrical device must not be within reach of the VDE test finger according to IEC 60529/DIN VDE 0470-1 (test finger).

Back of hand safety is specified for the "rest of the area" up to 100 mm around the operating element. **Back of hand safety** means that when a force of 50 N is applied to a ball with a diameter of 50 mm, this does not come into contact with the live parts of the equipment. No special measures for ensuring contact safety are stipulated outside this area.

Note: systems and equipment that are operated with SELV up to 25 V ~ or 60 V – are considered to be protected against "direct contact".

According to § 5, Subsection 4 of the BGV A 2 regulations, there is no need to test the condition of the system prior to initial start-up if the company has confirmation from the manufacturer or installer that the electrical systems and equipment conform to BGV A 2. The confirmation required relates to systems and equipment that have been installed and are ready for operation and can only be issued by the installer or installation company. The manufacturer of the electrical equipment can only issue a confirmation that products have been produced in accordance with the relevant electro-technical DIN VDE regulations stipulated in BGV A 2. The installer must bear this in mind when selecting the equipment to be used.

In the field of connection technology, Phoenix Contact offers a wide range of products that are touch proof or that can be protected against contact using covers. Depending on the conditions, all of this

must be taken into account when selecting the individual types of terminal block and accessories.

Quality features of insulating housing

Thermoplastics

The majority of our insulating housing is made from thermoplastic materials. Roughly speaking, these can be divided into amorphous and semi-crystalline substances. Thermoplastics are processed using the efficient and environmentally-friendly injection molding process. They have good recycling properties and can be re-used. We use many materials that are modified in different ways to meet the demanding requirements that electrical and electronic modules, devices, and systems have to meet with regard to their mechanical, thermal, and electrical properties.

Behavior of plastics under the influence of temperature (operating temperatures, mechanical influences)

All plastics undergo a process referred to as thermal aging when they are subjected to heat over long periods. This process causes changes in the mechanical and electrical properties of the material. External influences, e.g., radiation, additional mechanical, chemical or electrical stresses, amplify this effect. Special tests on samples can yield characteristic data which provides a good means of drawing comparisons between different plastics. However, applying these characteristics to an evaluation of molded plastic parts is only possible to a limited extent, and can only give the designer a rough guide when it comes to selecting a plastic material. This catalog uses the following assessment criteria: the **RTI value** according to UL746B/ANSI 746 B (elec. based on electric strength) and the **Ti value** according to IEC 60216-1 (based on a 50% reduction in tensile strength after 20,000 hours).

IEC 60947-7-1/EN 60947-7-1 specifies a permissible temperature increase of 45 K for terminal blocks under nominal load. Phoenix Contact terminal blocks meet this requirement.

The properties of plastics are not only affected by the influence of heat as described above; they also undergo changes as a result of cold influences. When subjected to cold as well as low levels of humidity, plastics become increasingly brittle with the result that they are no longer capable of withstanding the same mechanical loads. As the table on the right shows, the plastics concerned can be used down to a temperature of -40°C, but only without a mechanical load. As far as the products presented in the catalog are concerned, it is the ambient temperature specified in each case that is to be regarded as definitive for operation. Regardless of the plastics used, this may be subject to further restrictions (e.g., limited to -20°C) as a result of the components used or other restrictive parameters.

At very low temperatures, this means that any form of mechanical load on the plastic components must be avoided (e.g., mounting of products on/removal of products from the DIN rail, actuation of terminal points, locking/ejection of relays from bases, prizing out of jumpers, bending of cables and lines, etc.), as there is always an associated risk of damage. Unless otherwise indicated, it is recommended that you carry out the specified mounting/operational tasks in a temperature range from -10°C to +40°C.

Inflammability characteristics of plastics (UL 94)

The inflammability tests for plastics have been defined by the Underwriters Laboratory (USA) in regulation UL 94. This applies to all usage ranges, but in particular to electrical engineering. A horizontal or vertical test is carried out at the test laboratory to determine the inflammability of the plastic material with a naked flame. In order of increasing flame-retardant behavior, the evaluation classes are HB, V2, V1, V0, and 5V. Test results are recorded on "yellow cards" and are published annually in the **Recognized Component Directory**.

Thermoplastics: non-reinforced polyamide, PA

We use the modern, semi-crystalline polyamide insulation material, which has now become an essential component in electrical engineering and electronics. It has long occupied a leading position and is authorized for use by the relevant approval authorities such as the CSA, NEMKO, KEMA, PTB, SEV, UL, VDE, etc.

Polyamide also has excellent electrical, mechanical, chemical, and other properties, even at high operating temperatures. Brief peak temperatures up to approximately 200°C are permitted as a result of heat aging stabilization. Depending on the type (PA 4.6, 6.6, 6.10, etc.), its melting point is in the region of 215°C to 295°C.

Polyamide absorbs moisture from its surroundings, on average 2.8%. However, this moisture is not in the form of crystallization water in the plastic itself, but chemically bonded H₂O groups in the molecule structure. This makes the plastic flexible and resistant to breakage, even at temperatures as low as -40°C. According to UL 94, PA belongs to inflammability class V2 to V0.

Thermoplastics: Polyester, PBT

We use the semi-crystalline thermoplastic polyester in non-reinforced and fiberglass-reinforced variants for special applications which require increased dimensional and form stability.

In addition to the high operating temperature, the material is characterized by excellent mechanical strength and hardness, and does not absorb moisture from its surroundings. PBT is therefore particularly suitable for strips, for example, which are soldered onto PCBs and subsequently have to pass a burn-in test while they are subjected to heat. According to UL 94, PBT belongs to inflammability class V2 to V0.

Thermoplastics: polycarbonate, PC

Polycarbonate combines many advantages such as rigidity, impact strength, transparency, dimensional stability, good insulation properties, and resistance to heat.

This amorphous material only absorbs moisture to a very limited degree, and is used for items such as large, rigid electronic component housing.

In its transparent form, polycarbonate is particularly suitable for use as a material for cover profiles or marking materials.

PC has good resistance properties against mineral acids, saturated aliphatic hydrocarbons, gasoline, greases, and oils.

The material is less resistant to solvents, benzene, lyes, acetone, and ammonia. Strain cracks may result from contact with certain chemicals.

According to UL 94, PC belongs to inflammability class V2 to V0.

Thermoplastics: polycarbonate fiber-reinforced, PC-F

Compared to non-reinforced materials, fiber-reinforced polycarbonates feature greater rigidity, impact strength, and operating temperature. In other respects, their properties are largely identical to those of non-reinforced polycarbonate.

Thermoplastics: ABS

We use the thermoplastic molding compound ABS for products which must have good impact and notched impact properties in addition to high mechanical stability and rigidity. The products are resistant to chemicals and stress cracking due to their special surface quality and hardness.

The characteristic thermal properties provide good dimensional stability at both low and high temperatures. Products made from ABS can be coated with metallic surfaces, e.g., nickel.

The inflammability class of the molding compound used is HB to V0 according to UL 94.

Properties	Unit/level	Polyamide PA	Polyester PBT	Polycarbonate PC	Polycarbonate PC-F	ABS
Operating temperature RTI */**	°C	≤ 105	≤ 105	≤ 125	≤ 120	≤ 80
Minimum temperature (without mechanical load)	°C	-40	-40	-40	-40	-40
Dielectric strength acc. to IEC 60243-1/DIN VDE 0303-21	kV/cm	600	400	> 300		850
Resistance to creepage IEC 60112/DIN VDE 0303-1	CTI...M	550	225	175		200
	CTI...	600	225	175	175	600
Tropical and termite resistance		Good	Good	Good		
Specific contact resistance IEC 60093/VDE 0303 Part 30; IEC 60167/VDE 0303 Part 31	Ω cm	10 ¹²	10 ¹⁶	> 10 ¹⁶	> 10 ¹⁴	10 ¹⁴
Surface resistance IEC 60093/VDE 0303 Part 30; IEC 60167/VDE 0303 Part 31	Ω	10 ¹⁰	10 ¹³	> 10 ¹⁴		10 ¹³
Inflammability class according to UL 94		V2-V0	V0	V2-V0	V0	HB - V0

* According to UL 746 B/ANSI 746 B (elec.)

** Minimum value

Dimensions

Dimensions: Width/Height/Depth



The dimensions "Width/Height/Depth" are defined as follows for all DIN-rail-mountable products in the INTERFACE range:

- **Width:** measurement taken along the DIN rail
- **Height:** measurement taken across the DIN rail
- **Depth:** measurement taken starting from the mounting plate and including the NS 35/7,5 DIN rail (EN 60715)

The width, height, and depth never change, even if the products shown in this catalog happen to be photographed from two different perspectives (horizontal or vertical).

To make things easier for you, one of the following two symbols has been included next to each product photo:

EMC: Class A product:

In accordance with statutory regulations, our products are indicated with this footnote if they are intended for use in industrial environments. This means that the permitted limit values for residential applications may be exceeded in the event of conducted and emitted disturbance variables. In such cases, the operator may have to take additional safety measures in order to ensure electromagnetic compatibility in residential applications.

Note:

Subject to changes that serve the purpose of technical progress.

Connection cross section

The rated cross section of terminal blocks must be specified by the manufacturer according to IEC 60947-7-1. The rated cross section is the maximum conductor cross section that can be connected in single, multi or fine-strand versions subject to specific thermal, mechanical, and electrical requirements.

The manufacturer must also specify the **rated connection capacity**, i.e., the area of the conductor that can be connected, as well as the number of conductors that can be connected simultaneously and the necessary preparation of the conductor ends. The conductors can be **solid (single or multi-strand)** or **stranded (fine-strand)**.

These values can be found in the product-specific technical data.

The rated connection capacity of Phoenix Contact terminal blocks usually exceeds standard requirements, which specify that it must only be possible to connect one conductor with one of the two next smallest cross sections, excluding the rated cross section (standardized for the cross section range from 0.2 to 35 mm²).

In addition, conductors with a rated cross section can usually be wired with ferrules with plastic sleeve.

Phoenix Contact terminal blocks are designed to allow copper cables to be connected

to them without any special treatment. “Special treatment” or the use of ferrules – both permitted according to IEC 60947-7-1 – are not required. If ferrules are nevertheless used to protect stranded conductors against splicing, the connection capacity of the stranded conductor is generally reduced by one level.

Structure and dimensions of connecting cables

Cross section [mm ²]	Single-strand		Multi-strand		Fine-strand		Gauge No. AWG	American Wire Gauge [AWG]					
	Diameter max. dimension	Number of wires	Diameter max. dimension	Number of wires (minimum number)	Diameter max. dimension	Number of wires (guide value)		Solid wires			Stranded wires		
								[Ø mm]	[circ. mils]	[mm ²]	[Ø mm]	[circ. mils]	[mm ²]
0.2	0.5	1	–	–	–	–	24	0.51	404	0.21	–	–	–
0.5	0.9	1	1.1	7	1.1	16	20	0.81	1022	0.52	0.97	1111	0.56
0.75	1.0	1	1.2	7	1.3	24	18	1.02	1620	0.82	1.16	1600	0.82
1	1.2	1	1.4	7	1.5	32	(17)	1.15	2050	1.04	–	–	–
–	–	–	–	–	–	–	16	1.29	2580	1.31	1.50	2580	1.32
1.5	1.5	1	1.7	7	1.8	30	(15)	1.45	3260	1.65	–	–	–
–	–	–	–	–	–	–	14	1.63	4110	2.08	1.85	4100	2.09
2.5	1.9	1	2.2	7	2.3	50	(13)	1.83	5180	2.63	–	–	–
–	–	–	–	–	–	–	12	2.05	6530	3.31	2.41	6500	3.32
4	2.4	1	2.7	7	2.9	56	(11)	2.30	8230	4.17	–	–	–
–	–	–	–	–	–	–	10	2.59	10380	5.26	2.95	10530	5.37
6	2.9	1	3.3	7	3.9	84	(9)	2.91	13100	6.63	–	–	–
–	–	–	–	–	–	–	8	3.26	16510	8.37	3.73	16625	8.48

Tightening torque of terminal block screws

IEC 60947-1/EN 60947-1, modified, Table 4 specifies tightening torques for screw connections based on the screw size for electrical and mechanical type tests.

Extract from IEC 60947-1/EN 60947-1, Table 4

The torque according to IEC and the recommended torque for Phoenix Contact terminal blocks are specified

Thread	Head screw with slot	
	Torque	Recommended tightening torque
	[Nm]	[Nm]
M2.5 (M2.6)	0.4	0.4-0.5
M3	0.5	0.5-0.6
M3.5	0.8	0.8-1.0
M4	1.2	1.2-1.5

















































Current carrying capacity

Standard IEC 60947-7-1/EN 60947-7-1/DIN VDE 0611-1 specifies the test currents for the individual conductor cross sections listed in the adjacent table. The corresponding currents are listed with the connection data for the individual terminal blocks. The type tests of terminal blocks are based on this data.

Test currents according to IEC 60947-7-1/EN 60947-7-1, Table 5

Rated cross section	[mm ²]	0.2	0.5	0.75	1.0	1.5	2.5	4	6	10	16
Test current	[A]	4	6	9	13.5	17.5	24	32	41	57	76

Certification bodies and safety marks

Certification bodies and approvals	Country code	 Explosion protection	Country code	Ship classification societies	Country code
 IECEE CB Scheme (in combination with certifying body)	International	  International Electrotechnical Commission	International	 Bureau Veritas	FR
 CENELEC Certification Agreement (CCA inspection report) (in combination with certifying body)	EU	 DEKRA DEKRA Certification B.V.	NL	 Germanischer Lloyd AG	DE
 Canadian Standards Association (CSA)	CA	 Physikalisch-Technische Bundesanstalt	DE	 Lloyd's Register of Shipping	GB
 Canadian Standards Association (CSA) - CSA approval for the USA -	US	 KIWA Nederland B.V.	NL	 Nippon Kaiji Kyokai	JP
 Canadian Standards Association. (CSA) Combined logo - CSA approval for Canada and the USA -	CA US	 QS Schaffhausen AG	CH	 Det Norske Veritas	NO
 Underwriters Laboratories Inc. (UL)	US	 VTT Expert Services Oy	FI	 Polski Rejestr Statków	PL
 Underwriters Laboratories Inc. (UL) - UL approval for Canada -	CA	 IBEXU Institut für Sicherheitstechnik GmbH	DE	 Russian Maritime Register of Shipping	RU
 Underwriters Laboratories Inc. (UL) Combined logo - UL approval for the USA and Canada -	US CA	 TÜV Rheinland do Brasil	BR	 Korean Register of Shipping	KR
 INSIEME PER LA QUALITA'E LA SICUREZZA	IT	 Technischer Überwachungsverein Nord	DE	 American Bureau of Shipping	US
 Eurasian Conformity	BY KZ RU	 DEKRA EXAM GmbH	DE		
 DEKRA Certification B.V.	NL	 Canadian Standards Association (CSA)	CA		
 Österreichischer Verband für Elektrotechnik	AT	 Canadian Standards Association (CSA) - CSA approval for the USA -	US		
 electrosuisse SEV Verband für Elektro-, Energie- und Informationstechnik	CH	 Canadian Standards Association. (CSA) Combined logo - CSA approval for Canada and the USA -	CA US		
 Verband Deutscher Elektrotechniker e.V. (VDE) - Approval of drawings - Reports with production monitoring	DE	 Underwriters Laboratories Inc. (UL)	US		
 Berufsgenossenschaft (BG) GS - Geprüfte Sicherheit	DE	 Underwriters Laboratories Inc. (UL) - UL approval for Canada -	CA		
 Intertek ETL Listed - Approval for the USA -	US	 Underwriters Laboratories Inc. (UL) Combined logo - UL approval for the USA and Canada -	US CA		
 Intertek ETL Listed - Approval for Canada -	CA	 FM Approvals	US		
 Intertek ETL Listed - Approval for the USA and Canada -	US CA	 Eurasian Conformity for Ex-products	BY KZ RU		
 TÜV Rheinland Industrie Service GmbH	DE				
 China Compulsory Certificate	CN				

Type	Order No.	Page	Type	Order No.	Page	Type	Order No.	Page	Type	Order No.	Page
FL CAT6 PATCH 7.5	2891880	391	FL MGuard RS2005 TX VPN	2701875	318	FL SM PATCH 1,0 LC-ST	2989242	377	FL SWITCH LM 8TX-B	2989446	297
FL COMSERVER BAS 232/422/485-T	2904681	385	FL MGuard RS4000 TX/TX	2700634	317	FL SM PATCH 1,0 SC-SC	2901829	377	FL SWITCH LM 8TX-E	2891466	297
FL COMSERVER BASIC 232/422/485	2313478	385	FL MGuard RS4000 TX/TX VPN	2200515	317	FL SM PATCH 1,0 LC-ST	2901832	377	FL SWITCH SF 14TX/2FX	2832933	287
FL COMSERVER UNI 232/422/485	2313452	385	FL MGuard RS4004 TX/DTX	2701876	319	FL SM PATCH 1,0 ST-ST	2901836	377	FL SWITCH SF 15TX/FX	2832661	287
FL COMSERVER UNI 232/422/485-T	2904817	385	FL MGuard RS4004 TX/DTX VPN	2701877	319	FL SM PATCH 2,0 LC-LC	2989284	376	FL SWITCH SF 16TX	2832849	286
FL COUPLER SC-DUPLEX	2901788	379	FL MGuard SMART2	2700640	320	FL SM PATCH 2,0 LC-SC	2989297	377	FL SWITCH SF 4TX/3FX ST	2832603	287
FL CRIMPTOOL	2744869	390	FL MGuard SMART2 VPN	2700639	320	FL SM PATCH 2,0 LC-ST	2989349	377	FL SWITCH SF 6TX/2FX	2832933	287
FL DUST CVR BK	2891107	328	FL MM PATCH 1,0 LC-LC	2989158	376	FL SM PATCH 2,0 SC-SC	2901830	377	FL SWITCH SF 6TX/2FX ST	2832674	287
FL DUST CVR BN	2891301	328	FL MM PATCH 1,0 LC-SC	2989161	377	FL SM PATCH 2,0 SC-ST	2901833	377	FL SWITCH SF 7TX/FX	2832726	287
FL DUST CVR BU	2891204	328	FL MM PATCH 1,0 LC-SCRJ	2901802	377	FL SM PATCH 2,0 ST-ST	2901837	377	FL SWITCH SF 7TX/FX ST	2832577	287
FL DUST CVR GN	2891602	328	FL MM PATCH 1,0 LC-ST	2989174	377	FL SM PATCH 5,0 LC-LC	2901826	376	FL SWITCH SF 8TX	2832771	286
FL DUST CVR GY	2891505	328	FL MM PATCH 1,0 SC-SC	2901805	377	FL SM PATCH 5,0 LC-SC	2901827	377	FL SWITCH SFN 15TX/FX	2891934	281
FL DUST CVR RD	2891709	328	FL MM PATCH 1,0 SC-SCRJ	2901812	377	FL SM PATCH 5,0 LC-ST	2901828	377	FL SWITCH SFN 16TX	2891933	281
FL DUST CVR VT	2891806	328	FL MM PATCH 1,0 SC-ST	2901809	377	FL SM PATCH 5,0 SC-SC	2901831	377	FL SWITCH SFN 4TX/FX	2891851	279
FL DUST CVR WH	2891903	328	FL MM PATCH 1,0 SCRJ-SCRJ	2901823	377	FL SM PATCH 5,0 SC-ST	2901834	377	FL SWITCH SFN 4TX/FX ST	2891453	279
FL DUST CVR YE	2891408	328	FL MM PATCH 1,0 ST-SCRJ	2901820	377	FL SM PATCH 5,0 ST-ST	2901838	377	FL SWITCH SFN 5GT	2891444	282
FL EPA RMS	2701133	495	FL MM PATCH 1,0 ST-ST	2901815	377	FL SM PATCH COUPLER LC-LC	2700313	379	FL SWITCH SFN 5TX	2891152	279
FL EPA WMS	2701134	495	FL MM PATCH 2,0 LC-LC	2989255	376	FL SNMP OPC SERVER V3	2701139	453	FL SWITCH SFN 5TX-24VAC	2891201	280
FL FOC PN-B-980/1000	2313397	360	FL MM PATCH 2,0 LC-SC	2989268	377	FL SNMP OPC SERVER V3 LC 100	2701138	453	FL SWITCH SFN 5TX-PN	2891151	278
FL FOC PN-B-HCS-200/230	2313766	364	FL MM PATCH 2,0 LC-SCRJ	2901803	377	FL SWITCH 1001T-4POE	2891064	291	FL SWITCH SFN 6GT/2LX	2891987	283
FL FOC PN-C-FLEX-980/1000	2313407	362	FL MM PATCH 2,0 LC-ST	2989271	377	FL SWITCH 1008E	2891065	310	FL SWITCH SFN 6GT/2LX-20	2891563	283
FL FOC PN-C-HCS-GI-200/230	2313410	366	FL MM PATCH 2,0 SC-ST	2901807	377	FL SWITCH 1605 M12	2700200	290	FL SWITCH SFN 6GT/2SX	2891398	283
FL FXT	2989307	307	FL MM PATCH 2,0 SC-SCRJ	2901813	377	FL SWITCH 1708 M12 POE	2701883	291	FL SWITCH SFN 6TX/2FX	2891314	279
FL HUB 16TX-ZF	2832564	289	FL MM PATCH 2,0 SC-ST	2901810	377	FL SWITCH 1824	2891041	288	FL SWITCH SFN 6TX/2FX ST	2891411	279
FL HUB 8TX-ZF	2832551	289	FL MM PATCH 2,0 SCRJ-SCRJ	2901824	377	FL SWITCH 1924	2891057	288	FL SWITCH SFN 6TX/2FX-NF	2891024	279
FL IF 2FX SC-D	2832425	308	FL MM PATCH 2,0 ST-SCRJ	2901821	377	FL SWITCH 3004T-FX	2891033	293	FL SWITCH SFN 7GT/SX	2891518	283
FL IF 2FX SC-F	2832412	308	FL MM PATCH 2,0 ST-ST	2901816	377	FL SWITCH 3004T-FX ST	2891034	293	FL SWITCH SFN 7TX/FX	2891097	279
FL IF 2FX SM SC-D	2832205	308	FL MM PATCH 5,0 LC-LC	2901799	376	FL SWITCH 3005	2891030	292	FL SWITCH SFN 7TX/FX ST	2891110	279
FL IF 2FX ST-D	2884033	308	FL MM PATCH 5,0 LC-SC	2901800	377	FL SWITCH 3005T	2891032	292	FL SWITCH SFN 7TX/FX-NF	2891023	279
FL IF 2POF SCRJ-D	2891084	309	FL MM PATCH 5,0 LC-SCRJ	2901804	377	FL SWITCH 3006T-2FX	2891036	293	FL SWITCH SFN 8GT	2891673	282
FL IF 2PSE-F	2832904	308	FL MM PATCH 5,0 LC-ST	2901801	377	FL SWITCH 3006T-2FX SM	2891060	293	FL SWITCH SFN 8TX	2891929	279
FL IF 2TX VS-RJ-D	2832357	308	FL MM PATCH 5,0 SC-SC	2901808	377	FL SWITCH 3006T-2FX ST	2891037	293	FL SWITCH SFN 8TX-24VAC	2891020	280
FL IF 2TX VS-RJ-F	2832344	308	FL MM PATCH 5,0 SC-SCRJ	2901814	377	FL SWITCH 3008	2891031	292	FL SWITCH SFN 8TX-NF	2891022	279
FL ISOLATOR 100-M12	2902985	387	FL MM PATCH 5,0 SC-ST	2901811	377	FL SWITCH 3008T	2891035	292	FL SWITCH SFN 8TX-PN	2891018	278
FL ISOLATOR 100-M12 RMS	2904671	387	FL MM PATCH 5,0 SCRJ-SCRJ	2901825	377	FL SWITCH 3012E-2SFX	2891067	311	FL SWITCH SFN 8TX-FX	2891027	277
FL ISOLATOR 100-RJ/RJ	2313931	387	FL MM PATCH 5,0 ST-SCRJ	2901822	377	FL SWITCH 3016	2891058	292	FL SWITCH SFNB 8TX/FX SM20	2891029	277
FL ISOLATOR 100-RJ/SC	2313928	387	FL MM PATCH 5,0 ST-ST	2901817	377	FL SWITCH 3016E	2891066	311	FL SWITCH SFNB 4TX/FX ST	2891028	277
FL ISOLATOR 1000-RJ/RJ	2313915	386	FL MM PATCH COUPLER LC-LC	2700312	379	FL SWITCH 3016T	2891059	292	FL SWITCH SFNB 5TX	2891001	276
FL LCX 50-OHM	2884978	520	FL NP SMN 8TX	2989365	306	FL SWITCH 4008T-2GT-4FX SM	2891061	295	FL SWITCH SFNB 8TX	2891002	277
FL LCX CABLE METER	2884774	520	FL NP PND-4TX IB	2985974	326	FL SWITCH 4008T-2SFP	2891062	294	FL SWITCH SFNB 14TX/2FX	2891954	281
FL LCX CLAMP	2884994	520	FL NP PND-4TX IB-LK	2985929	327	FL SWITCH 4012T-2GT-2FX	2891063	295	FL SWITCH SFNT 15TX/FX	2891953	281
FL LCX CON-NF	2884965	520	FL NP PND-4TX PB	2985071	327	FL SWITCH 4800E-P1	2891075	312	FL SWITCH SFNT 16TX	2891952	281
FL LCX PIG-EF142-N-N	2700677	517	FL PA SFNT 5-8	2891012	284	FL SWITCH 4800E-P5	2891076	312	FL SWITCH SFNT 4TX/FX	2891004	285
FL LCX TOOL	2884981	520	FL PATCH CCODE BK	2891194	329	FL SWITCH 4808E-16FX LC-4GC	2891073	313	FL SWITCH SFNT 4TX/FX-C	2891044	285
FL MC 1000 SC	2891320	382	FL PATCH CCODE BN	2891495	329	FL SWITCH 4808E-16FX SM LC-4GC	2891074	313	FL SWITCH SFNT 5GT	2891390	283
FL MC 1000 ST	2891321	382	FL PATCH CCODE BU	2891291	329	FL SWITCH 4808E-16FX SM ST-4GC	2891086	313	FL SWITCH SFNT 5GT-C	2891391	283
FL MC 2000E LC	2891056	383	FL PATCH CCODE GN	2891796	329	FL SWITCH 4808E-16FX SM-4GC	2891080	313	FL SWITCH SFNT 5TX	2891003	284
FL MC 2000E SM40 LC	2891156	383	FL PATCH CCODE GY	2891699	329	FL SWITCH 4808E-16FX ST-4GC	2891085	313	FL SWITCH SFNT 5TX-C	2891043	284
FL MC 2000T SC	2891315	383	FL PATCH CCODE RD	2891893	329	FL SWITCH 4808E-16FX-4GC	2891079	313	FL SWITCH SFNT 6TX/2FX	2891025	285
FL MC 2000T SM20 SC	2891317	383	FL PATCH CCODE VT	2891990	329	FL SWITCH 4824E-4GC	2891072	312	FL SWITCH SFNT 6TX/2FX ST	2891026	285
FL MC 2000T SM40 SC	2891318	383	FL PATCH CCODE YE	2891592	329	FL SWITCH 7005FX-2FXSM-EIP	2701420	305	FL SWITCH SFNT 6TX/2FX ST-C	2891049	285
FL MC 2000T ST	2891316	383	FL PATCH GUARD	2891424	329	FL SWITCH 7006/2FX-EIP	2701419	305	FL SWITCH SFNT 6TX/2FX-C	2891048	285
FL MC EF 1300 MM SC	2902853	381	FL PATCH GUARD KEY	2891521	329	FL SWITCH 7008-EIP	2701418	304	FL SWITCH SFNT 7TX/FX	2891006	285
FL MC EF 1300 MM ST	2902854	381	FL PATCH SAFE CLIP	2891246	329	FL SWITCH GHS 12G/8	2989200	307	FL SWITCH SFNT 7TX/FX ST	2891007	285
FL MC EF 1300 SM SC	2902856	381	FL PLUG GUARD GN	2891615	328	FL SWITCH GHS 12G/8-L3	2700787	307	FL SWITCH SFNT 7TX/FX ST-C	2891047	285
FL MC EF WDM-A SC	2902658	380	FL PLUG GUARD KEY	2891327	328	FL SWITCH GHS 4G/12	2700271	307	FL SWITCH SFNT 7TX/FX-C	2891046	285
FL MC EF WDM-B SC	2902659	380	FL PLUG GUARD RD	2891712	328	FL SWITCH GHS 4G/12-L3	2700786	307	FL SWITCH SFNT 8TX	2891005	284
FL MC EF WDM-SET SC	2902660	380	FL PLUG GUARD WH	2891819	328	FL SWITCH IRT 2TX 2POF	2700691	303	FL SWITCH SFNT 8TX-C	2891045	284
FL MC ETH/FO 660 T	2313164	289	FL PLUG RJ45 GN2	2744571	390	FL SWITCH IRT 4TX	2700689	302	FL SWITCH SMCS 14TX/2FX	2700997	301
FL MEM PLUG	2891259	309	FL PLUG RJ45 GR2	2744856	390	FL SWITCH IRT IP TX/3POF	2700697	303	FL SWITCH SMCS 14TX/2FX-SM	2701466	301
FL MEM PLUG/MRM	2891275	309	FL PN/PN SDIO-2TX/2TX	2700651	92	FL SWITCH IRT TX 3POF	2700692	303	FL SWITCH SMCS 16TX	2700996	301
FL MGuard DM 100	2700183	323	FL PORT GUARD	2891220	328	FL SWITCH LM 4TX/1FX	2989624	297	FL SWITCH SMCS 6GT/2SFP	2891479	301
FL MGuard DM DEVICE UPGRADE	2700223	323	FL PSE 2TX	2891013	291	FL SWITCH LM 4TX/1FX SM	2989828	297	FL SWITCH SMCS 6TX/2SFP	2989323	301
FL MGuard DM UNLIMITED	2981974	323	FL RED 2001E PRP 2LC	2701864	315	FL SWITCH LM 4TX/1FX SM ST	2989925	297	FL SWITCH SMCS 8GT	2891123	300
FL MGuard DM UPD	2700222	323	FL RED 2003E PRP	2701863	314	FL SWITCH LM 4TX/1FX SM ST-E	2989734	297	FL SWITCH SMCS 8TX	2989226	300
FL MGuard GT/GT	2700197	317	FL RJ45 PROTECT CAP	2832991	329	FL SWITCH LM 4TX/1FX SM-E	2989637	297	FL SWITCH SMCS 6TX/2POF-PN	2700290	299
FL MGuard GT/GT VPN	2700198	317	FL robust BOX	2701204	520	FL SWITCH LM 4TX/1FX ST	2989721	297	FL SWITCH SMN 8TX-PN	2989501	299
FL MGuard LIC CIM	2701083	316	FL robust BOX DIR-1	2701440	520	FL SWITCH LM 4TX/1FX ST-E	2989530	297	FL VIEW 256	2701473	322
FL MGuard LIC FW RD	2701356	316	FL robust BOX OMNI-1	2701430	520	FL SWITCH LM 4TX/1FX-E	2989433	297	FL VIEW 32 LITE	2701744	322
FL MGuard LIC FW/VPN RD	2702193	317	FL robust BOX OMNI-2	2701439	520	FL SWITCH LM 4TX/1FX	2832658	298	FL VIEW 512	2701474	322
FL MGuard LIC LIFETIME FW	2700184	316	FL robust BOX POLE SET	2701205	520	FL SWITCH LM 4TX/2FX SM	2891916	298	FL VIEW 64	2701472	322
FL MGuard LIC OPC INSP	2702191	316	FL SD FLASH/L3/MRM	2700607	307	FL SWITCH LM 4TX/2FX SM ST	2989239	298	FL WLAN 5100	2700718	494
FL MGuard LIC VPN-250	2700193	397	FL SD FLASH/MRM	2700270	307	FL SWITCH LM 4TX/2FX SM ST-E	2989938	298	FL WLAN 5101	2701093	494
FL MGuard LIC VPN-250 GROUP	2700192	397	FL SFP FX	2891081	309	FL SWITCH LM 4TX/2FX SM-E	2891864	298	FL WLAN 5102	2701850	494
FL MGuard PCI4000	2701274	321	FL SFP FX SM	2891082	309	FL SWITCH LM 4TX/2FX ST	2989132	298	FL WLAN EPA	2692791	495
FL MGuard PCI4000 VPN	2701275	321	FL SFP LH	2989912	309	FL SWITCH LM 4TX/2FX ST-E	2989831	298	FL WLAN EPA 5N	2700488	495
FL MGuard PCIE4000 VPN	2701278	321	FL SFP LX	2891767	309	FL SWITCH LM 4TX/2FX-E	2891660	298	FL WLAN EPA R5MA	2701169	495
FL MGuard PROF SERVICE 2	2700185	323	FL SFP SX	2891754	309	FL SWITCH LM 5TX	2989527	296	FL-PP-RJ45-LSA	2901645	389
FL MGuard RS2000 TX/TX VPN	2700642	317	FL SM PATCH 1,0 LC-LC	298918							

Type	Order No.	Page	Type	Order No.	Page	Type	Order No.	Page	Type	Order No.	Page
ILB BT ADIO 2/2/16/16	2884282	505	NBC-MSD/ 5,0-93E/FSD SCO	1407402	255	PLD M 360 W-50 365	2701690	13	PSI-MOS-PROFIB/FO 660 T	2708287	343
ILB BT ADIO MUX-OMNI	2884208	504	NBC-MSD/ 5,0-93E/FSD SCO	1407378	255	PLD M 360 W-50 695	2701691	13	PSI-MOS-PROFIB/FO 850 E	2708274	343
ILB BT ADIO MUX-OMNI 8M	2693185	504	NBC-MSD/10,0-93B SCO	1407498	254	PROJECT+	2988667	454	PSI-MOS-PROFIB/FO 850 T	2708261	343
ILB BT ADIO MUX-PANEL	2884509	504	NBC-MSD/10,0-93B/FSD SCO	1407556	254	PROT-M12	1680539	253	PSI-MOS-PROFIB/FO 1300 E	2708559	343
ILB CO 24 DI16 DO16	2862592	222	NBC-MSD/10,0-93B/MSD SCO	1407527	254	PROT-M12 FS	1560251	253	PSI-MOS-PROFIB/FO 1300 T	2708892	343
ILB DN 24 DI16 DO16	2862602	222	NBC-MSD/10,0-93E SCO	1407359	255	PROT-M8	1682540	253	PSI-MOS-RS232/FO 660 E	2708368	353
ILB ETH 24 DI16 DIO16-2TX	2832962	222	NBC-MSD/10,0-93E/FSD SCO	1407403	255	PSD-S AE BM2-1 85DB	2700136	18	PSI-MOS-RS232/FO 660 T	2708410	353
ILB IB 24 DI 8 DO 8	2862372	222	NBC-MSD/10,0-93E/MSD SCO	1407379	255	PSD-S AE SC1-2 105DB	2700139	18	PSI-MOS-RS232/FO 850 E	2708371	353
ILB IB 24 DI16	2862330	222	NLC-035-024D-04I-02QRD-05A	2702031	464	PSD-S AE SM7-4 100DB/3	2700141	19	PSI-MOS-RS232/FO 850 T	2708423	353
ILB IB 24 DI16 DO16	2862398	222	NLC-050-024D-06I-04QRTN-05A	2701043	463	PSD-S AE SM8-5 100DB/1	2700138	19	PSI-MOS-RS232/FO 1300 E	2708588	353
ILB IB 24 DI16 DO16-DSUB	2878625	222	NLC-050-024D-06I-04QTN-00A	2701030	462	PSD-S AE SP1-3 100DB/2	2700137	19	PSI-MOS-RS422/FO 660 E	2708342	351
ILB IB 24 DI32	2862343	222	NLC-050-024D-06I-04QTP-00A	2701027	462	PSD-S AE V15/1	2700140	19	PSI-MOS-RS422/FO 660 T	2708384	351
ILB IB 24 DO16	2862356	222	NLC-050-024X-08I-04QXR-05A	2701056	463	PSD-S AS CABLE GLAND M16X1,5	2700145	20	PSI-MOS-RS422/FO 850 E	2708355	351
ILB IB 24 DO32	2862398	222	NLC-050-100A-08I-04QRA-05A	2701069	463	PSD-S AS END COVER	2700148	15	PSI-MOS-RS422/FO 850 T	2708397	351
ILB IB A14 A02	2878777	222	NLC-055-012D-08I-04QRD-05A	2700486	461	PSD-S AS LABEL BOARD	2700147	15	PSI-MOS-RS422/FO 1300 E	2708575	351
ILB PB 24 DI 8 DIO8	2863562	222	NLC-055-024D-08I-04QRD-05A	2700464	460	PSD-S CE-SM SCREW	2700093	20	PSI-MOS-RS485W2/FO 660 E	2708313	349
ILB PB 24 DI16 DO16	2862411	222	NLC-055-024D-08I-04QTP-00A	2700453	461	PSD-S CE-SM SPRING	2700091	20	PSI-MOS-RS485W2/FO 660 T	2708300	349
ILB PB 24 DI32	2862398	222	NLC-055-100A-08I-04QRA-05A	2700487	461	PSD-S CE-TM SCREW	2700095	20	PSI-MOS-RS485W2/FO 850 E	2708339	349
ILB PB 24 DO32	2862408	222	NLC-COM-ENET-MB1	2701124	468	PSD-S CE-TM SPRING	2700092	20	PSI-MOS-RS485W2/FO 850 T	2708326	349
ILB PB A14 A02	2878874	222	NLC-COM-GSM	2701344	468	PSD-S ME A-SH M18	2700150	21	PSI-MOS-RS485W2/FO 1300 E	2708562	349
ILB PN 24 DI16 DIO16-2TX	2878146	222	NLC-IO-03I-04QRD-05A	2701328	465	PSD-S ME B-M	2700164	21	PSI-REP-CNET	2313737	336
ILB S3 24 DI8 DO4 A02 INC-IN2	2700174	222	NLC-IO-06I-04QTN-01A	2701085	465	PSD-S ME B-P	2700163	21	PSI-MOS-RN232/FO 1300 E	2313423	337
ILC 130 SBT V2 STARTERKIT	2700993	82	NLC-IO-06I-04QTP-01A	2701072	465	PSD-S ME BR-BM	2700143	21	PSI-REP-PROFIBUS/12MB	2708863	334
ILC 131 ETH	2700973	474	NLC-IO-2AI-2AO-01	2701040	466	PSD-S ME BR-BM/HCR	2700149	21	PSI-REP-RS485W2	2313096	335
ILC 131 ETH/XC	2701034	474	NLC-IO-2RTD/UTH-4QTP-01A	2701671	467	PSD-S ME BR-SM	2700144	20	PSI-SC-DNET CAN	2313449	337
ILC 131 STARTERKIT	2701835	487	NLC-IO-4AI	2701098	466	PSD-S ME BR-SM/1S	2700160	20	PSI-TERMINATOR-PB	2313944	335
ILC 151 ETH	2700974	475	NLC-IOX-04I-02QRD-05A	2702032	465	PSD-S ME BR-SM/2S	2700161	20	PSI-WL-PROFIB/BT-SET/2DO	2313876	509
ILC 151 ETH/XC	2701141	475	NLC-MOD-CAP	2701289	460	PSD-S ME BT 110	2700156	21	PSI-WL-RS232-RS485/BT/2DO	2313805	508
ILC 151 GSM/GPRS	2700977	476	NLC-MOD-CAP-PXC	2701292	460	PSD-S ME FB	2700151	21	PSI-WL-RS232-RS485/BT/HL	2313795	508
ILC 171 ETH 2TX	2700975	475	NLC-MOD-MEM 032K	2701166	472	PSD-S ME OB	2700153	20	PSM PTK	2760623	417
ILC 191 ETH 2TX	2700976	475	NLC-MOD-RS232	2701179	469	PSD-S ME OB/MB	2700155	21	PSM PTK-4	2799364	417
ILC 191 ME/AN	2700074	477	NLC-MOD-RS485	2701182	469	PSD-S ME T-M 1000	2700154	21	PSM-AD-D9-NULMODEM	2708753	93
ILC 191 ME/INC	2700075	477	NLC-MOD-RTC	2701153	472	PSD-S ME T-M 250	2700157	21	PSM-CABLE-PROFIB/FC	2744652	407
ILC 350 PN	2876928	478	NLC-MOD-USB	2701195	469	PSD-S ME T-M 400	2700158	21	PSM-EG-RS232/RS422-P/4K	2761266	341
ILC 390 PN 2TX-IB	2985314	479	NLC-NAV-01	2701221	440	PSD-S ME T-P 45	2700152	21	PSM-FO-POWERMETER	2799539	378
IMC 1,5/ 5-ST-3,81SET I IFS 2M	1784729	209	NLC-OP1-COVER	2701276	460	PSD-S OE LED BL BU	2700132	16	PSM-FO-POWERMETER SCRJ-SET	2901560	378
			NLC-OP1-LCD-032-4X20	2701137	471	PSD-S OE LED BL CL	2700128	16	PSM-HCS-CLEAVETOOL	2744995	378
			NLC-OP1-MKT	2701140	471	PSD-S OE LED BL GN	2700121	16	PSM-HCS-CLEAVETOOL/B-FOC	2708478	378
			NLC-OP1-MKT-BASE	2701250	470	PSD-S OE LED BL RD	2700114	16	PSM-HCS-CLEAVETOOL/SCRJ	2313122	378
			NLC-OP1-MKT-BRACKET	2701263	471	PSD-S OE LED BL YE	2700123	16	PSM-HCS-KONFTOOL	2799526	378
			NLC-OP1-MKT-CBL	2701438	471	PSD-S OE LED BU	2700131	16	PSM-HCS-KONFTOOL/B-FOC	2708465	378
			NLC-OP2-LCD-076-4X20	2701945	470	PSD-S OE LED CL	2700127	16	PSM-HCS-KONFTOOL/SC-RJ	2708876	378
			NLC-PC/SERIAL-CBL 2M	2701234	464	PSD-S OE LED FL BU	2700134	17	PSM-KA 9 SUB 25/BB/2METER	2761059	416
			NLC-PC/USB-CBL 2M	2701247	469	PSD-S OE LED FL CL	2700129	17	PSM-KA9SUB9/BB/0,5METER	2708520	416
MC 1,5/ 5-ST-3,81	1803604	69	NLC-RS485-CBL-5M	2701073	469	PSD-S OE LED FL RD	2700115	17	PSM-KA9SUB9/BB/2METER	2799474	416
ME 17,5 TBUS 1,5/ 5-ST-3,81 GN	2709561	334	NLC-START-01	2701399	473	PSD-S OE LED FL YE	2700124	17	PSM-LWL-GDM-robust-50/125	2799322	372
ME 17,5 TBUS 1,5/PP000-3,81 BK	2890014	343	NLC-START-02	2701425	473	PSD-S OE LED GN	2700119	16	PSM-LWL-GDO-50/125	2799432	374
ME 22,5 TBUS 1,5/ 5-ST-3,81 GN	2707437	431	NLC-START-03	2701467	473	PSD-S OE LED MC	2702090	15	PSM-LWL-HCS-robust-200/230	2799885	368
ME 6,2 TBUS-2 1,5/5-ST-3,81 GN	2869728	69	NLC-START-04	2701483	473	PSD-S OE LED RD	2700107	16	PSM-LWL-HCSO-200/230	2799445	370
MINI-SYS-PS-100-240AC/24DC/1,5	2866983	334				PSD-S OE LED RFL BU	2700135	17	PSM-LWL-KDHEAVY-980/1000	2744319	354
						PSD-S OE LED RFL BU	2700130	17	PSM-LWL-robust-980/1000	2744322	356
						PSD-S OE LED RFL RD	2700118	17	PSM-LWL-robust-FLEX-980/1000	2744335	358
						PSD-S OE LED RFL YE	2700126	17	PSM-ME-RS232/RS232-P	2744461	338
						PSD-S OE LED RL RD	2700116	17	PSM-ME-RS232/RS485-P	2744416	341
						PSD-S OE LED RL YE	2700125	17	PSM-ME-RS232/TTY-P	2744458	339
						PSD-S OE LED YE	2700122	16	PSM-ME-RS485/RS485-P	2744429	335
NBC- 1,0-93B/FSD SCO	1407528	254	PB ECO LINK	2741480	264	PSI-BRIDGE-DNET CAN	2313533	337	PSM-POF-KONFTOOL	2744131	378
NBC- 1,0-93E/FSD SCO	1407380	255	PC Worx BASIC LIC	2985275	439	PSI-CA-USB A/MINI B/1METER	2313575	416	PSM-SET-B-FOC/4-HCS	2708481	379
NBC- 2,0-93B/FSD SCO	1407529	254	PC Worx BASIC-PRO LIC	2985259	439	PSI-CAB-GSM/UMTS- 5M	2900980	392	PSM-SET-B-FOC/4-HCS/PN	2313782	379
NBC- 2,0-93E/FSD SCO	1407381	255	PC Worx DEMO	2985725	439	PSI-CAB-GSM/UMTS-10M	2900981	392	PSM-SET-BFOC-LINK/2	2799429	379
NBC- 5,0-93B/FSD SCO	1407530	254	PC Worx EXPRESS	2988670	439	PSI-DATA/BASIC-MODEM/RS232	2313067	404	PSM-SET-FSMA-LINK/2	2799416	379
NBC- 5,0-93E/FSD SCO	1407382	255	PC Worx PRO LIC	2985385	439	PSI-GPRS/GSM-MODEM/RS232-QB	2313106	391	PSM-SET-FSMA-POLISH	2799348	379
NBC-10,0-93B/FSD SCO	1407531	254	PC Worx RT BASIC	2700291	484	PSI-GSM/UMTS-ANT-OMNI-2-5	2900982	405	PSM-SET-FSMA/4-HCS	2799487	379
NBC-10,0-93E/FSD SCO	1407383	255	PC Worx SRT	2701680	484	PSI-GSM/UMTS-QB-ANT	2313371	405	PSM-SET-FSMA/4-KT	2799720	379
NBC-MSD/ 1,0-93B SCO	1407495	254	PC Worx UA SERVER-PLC 40	2402685	452	PSI-MODEM-3G/ROUTER	2314008	395	PSM-SET-SC-DUPLEX/2-HCS/PN	2313779	379
NBC-MSD/ 1,0-93E/FSD SCO	1407553	254	PC Worx UA SERVER-PLC 80	2402686	452	PSI-MODEM-BASIC/USB	2313436	401	PSM-SET-SCRJ-DUP/2-HCS	2313070	379
NBC-MSD/ 1,0-93B/MSD SCO	1407524	254	PC Worx UA SERVER-PLC10	2402684	452	PSI-MODEM-GSM/ETH	2313355	395	PSM-SET-SCRJ-DUP/2-HCS/PN	2313546	379
NBC-MSD/ 1,0-93E SCO	1407356	255	PLD CM 360 PB	2701695	10	PSI-MODEM-SHDSL/ETH	2313643	403	PSM-SET-SCRJ-DUP/2-POF	2708656	379
NBC-MSD/ 1,0-93E/FSD SCO	1407400	255	PLD CM 360 PN	2702166	11	PSI-MODEM-SHDSL/PB	2313656	403	PSM-STRIP-FC/PROFIB	2744623	407
NBC-MSD/ 1,0-93E/MSD SCO	1407376	255	PLD E 400 W 250	2702221	7	PSI-MODEM-SHDSL/SERIAL	2313669	403	PSM-STRIP-KNIFEBLOCK	2744636	407
NBC-MSD/ 2,0-93B SCO	1407496	254	PLD E 400 W 375	2702222	7	PSI-MODEM/ETH	2313300	401	PSR-CONF-WIN1.0	2981554	89
NBC-MSD/ 2,0-93B/FSD SCO	1407554	254	PLD E 400 W 500	2702223	7	PSI-MOS-CNET/FO 850 E	2313711	345	PSR-FTB/1.5/11.5	2904476	81
NBC-MSD/ 2,0-93B/MSD SCO	1407525	254	PLD E 608 W 265	2702224	8	PSI-MOS-CNET/FO 850 T	2313724	345	PSR-FTB/20/86	2790447	81
NBC-MSD/ 2,0-93E SCO	1407357	255	PLD E 608 W 315/B	2702227	9	PSI-MOS-DNET CAN/FO 660/BM	2708054	347	PSR-MC20-3NO-1DO-24DC-SC	2700466	36
NBC-MSD/ 2,0-93E/FSD SCO	1407401	255	PLD E 608 W 315/E	2702228	9	PSI-MOS-DNET CAN/FO 660/EM	2708067	347	PSR-MC20-3NO-1DO-24DC-SP	2700467	36
NBC-MSD/ 2,0-93E/MSD SCO	1407377	255	PLD E 608 W 315/F	2702226	9	PSI-MOS-DNET CAN/FO 850/BM	2708083	347	PSR-MC30-2NO-1DO-24DC-SC	2700498	37
NBC-MSD/ 5,0-93B SCO	1407497	254	PLD M 360 W-100 200	2701692	12						

Index

Alphabetical

Type	Order No.	Page	Type	Order No.	Page	Type	Order No.	Page	Type	Order No.	Page
PSR-MC40-3NO-1DO-24DC-SP	2700570	38	PSR-SPP-24DC/ESD/4X1/30	2981813	44				RAD-PIG-EF316-MCX-N	2867681	517
PSR-MC50-3NO-1DO-24DC-SC	2700553	39	PSR-SPP-24DC/ESD/5X1/1X2/T 1	2981156	45				RAD-PIG-EF316-MCX-SMA	2867678	517
PSR-MC50-3NO-1DO-24DC-SP	2700564	39	PSR-SPP-24DC/ESD/5X1/1X2/T 3	2981237	45				RAD-PIG-EF316-N-RSMA	2701402	517
PSR-MS20-1NO-1DO-24DC-SC	2904950	31	PSR-SPP-24DC/ESD/5X1/1X2/T 5	2981279	45	R			RAD-PIG-EF316-N-SMA	2867694	517
PSR-MS25-1NO-1DO-24DC-SC	2904951	31	PSR-SPP-24DC/ESD/5X1/1X2/T 10	2981091	45	RAD-2400-ANT-OMNI-6-0-SW	2903219	515	RAD-PIG-RSMA-N-EX/ATEX	2904788	517
PSR-MS30-1NO-24DC-SC	2904952	32	PSR-SPP-24DC/ESD/5X1/1X2/T 30	2981350	45	RAD-2400-IFS	2901541	499	RAD-PIG-RSMA/N-0.5	2903263	519
PSR-MS35-1NO-24DC-SC	2904953	32	PSR-SPP-24DC/ESD/5X1/1X2/OT 5	2981130	45	RAD-80211-XD/HP	2900046	511	RAD-PIG-RSMA/N-1	2903264	517
PSR-MS40-1NO-1DO-24DC-SC	2904954	33	PSR-SPP-24DC/ESD/5X1/1X2/300	2981431	44	RAD-80211-XD/HP-BUS	2900047	511	RAD-PIG-RSMA/N-2	2903265	517
PSR-MS45-1NO-1DO-24DC-SC	2904955	33	PSR-SPP-24DC/ESP/4/2X1/1X2	2981017	74	RAD-868-CONF-RF1	2702197	499	RAD-PIG-RSMA/N-3	2903266	517
PSR-MS50-1NO-1DO-24DC-SC	2904956	34	PSR-SPP-24DC/FSP/1X1/1X2	2981981	72	RAD-868-IFS	2904909	499	RAD-PIG-RSMA/N-5	2702140	517
PSR-MS55-1NO-1DO-24DC-SC	2904957	34	PSR-SPP-24DC/FSP/2X1/1X2	2986957	73	RAD-900-CONF-RF1	2702122	499	RAD-PT100-4-IFS	2904035	503
PSR-MS60-2NO-24DC-SC	2904958	35	PSR-SPP-24DC/FSP/2X1/1X2	2986588	73	RAD-900-IFS	2901540	499	RAD-SPL-2-N/N	2702293	519
PSR-PC20-1NO-1NC-24DC-SC	2700577	69	PSR-SPP-24DC/RSM4/4X1	2981541	62	RAD-ADP-N/F-N/F	2867843	518	RAD-TAPE-SV-19-3	2903182	518
PSR-PC20-1NO-1DO-24DC-SP	2700578	69	PSR-SPP-24DC/SDC/4/2X1/B	2981499	51	RAD-ADP-N/M-SMA/F	2917036	518	RAD-WHA-1/2NPT	2900100	507
PSR-PC40-2NO-1DO-24DC-SC	2700588	70	PSR-SPP-24DC/SIM4	2981949	53	RAD-ADP-RSMA/F-SMA/F	2884538	518	RAD-WHG/WLAN-XD	2900178	506
PSR-PC40-2NO-1DO-24DC-SP	2700589	70	PSR-SPP-24DC/TS/M	2986025	79	RAD-ADP-SMA/F-SMA/F	2884541	518	REL-SR-24DC/2X21	2961574	65
PSR-PC50-1NO-1DO-24DC-SC	2904664	71	PSR-SPP-24DC/TS/S	2986232	78	RAD-ADP-SMA/F-SMA/M-90	2917324	518	RESY-DATA-A LIC	2876847	485
PSR-PC50-1NO-1DO-24DC-SP	2904665	71	PSR-SPP-24DC/TS/SDI8/SDIO4	2986041	80	RAD-AI4-IFS	2901537	502	RESYGATE 1000	2400128	404
PSR-PIP-24DC/MXF1/4X1/2X2/B	2903253	57	PSR-SPP-24DC/TS/SDOR4/4X1	2986106	80	RAD-AI4-U-IFS	2702290	502	RESYGATE 3000	2400129	404
PSR-PIP-24DC/MXF2/4X1/2X2/B	2903256	57	PSR-SPP-24DC/URD3/4X1/2X2	2981525	52	RAD-ANT-VAN-MKT	2885870	514	RFC 460R PN 3TX	2700784	483
PSR-PIP-24DC/MXF3/4X1/2X2/B	2903259	57	PSR-SPP-24DC/URD3/4X1/2X2/3	2981745	51	RAD-AO4-IFS	2901538	503	RFC 470 PN 3TX	2916600	482
PSR-PS20-1NO-1NC-24DC-SC	2700356	67	PSR-SPP-24DC/URD3/4X1/2X2/T 2	2981729	52	RAD-CAB-EF142-3M	2884512	517	RFC 470S PN 3TX	2916794	93
PSR-PS21-1NO-1NC-24DC-SC	2700357	68	PSR-SPP-24DC/URM4/4X1/2X2/B	2981680	51	RAD-CAB-EF142-5M	2884525	517	RFC DUAL-FAN	2730239	93
PSR-PS40-1NO-1DO-24DC-SC	2700398	68	PSR-SPP-24UC/ESA2/4X1/1X2/B	2963954	40	RAD-CAB-EF393-3M	2867649	517	RL PN 24-2 DI 16 2TX	2773652	271
PSR-PS40-1NO-1DO-24DC-SC	2700398	68	PSR-SPP-24UC/ESA4/2X1/1X2	2900526	41	RAD-CAB-EF393-5M	2867652	517	RL PN 24-2 DIO 16/8 2TX	2773652	271
PSR-SACB-4/4-L-5.0PUR-SD	2981871	55	PSR-SPP-24UC/URM/3X1/3X2	2900510	42	RAD-CAB-EF393-10M	2867665	517	RL PN 24-2 DIO 8/8 2SCRJ	2773513	271
PSR-SACB-4/4-L-10.0PUR-SD	2981884	55	PSR-SPP-24UC/URM/3X1/1X2/B	2963996	43	RAD-CAB-EF393-15M	2885634	517	RL PN 24-2 OC 2SCRJ	2700654	271
PSR-SCF-24UC/URM/2X21	2981363	65	PSR-SPP-24UC/ESL4/3X1/1X2/B	2981062	46	RAD-CAB-LMR400-10	5606124	523			
PSR-SCF-24UC/URM/4X1/2X2	2981444	65	PSR-SPP-24UC/THC4/2X1/1X2	2963983	47	RAD-CAB-LMR400-100	2867238	523			
PSR-SCF-120UC/URM/2X21	2981376	65	PSR-SPP-24UC/URM/3X1/3X2	2981842	64	RAD-CAB-LMR400-20	5606125	523			
PSR-SCF-120UC/URM/4X1/2X2	2981460	65	PSR-SPP-24UC/URM/5X1/1X2	2981965	64	RAD-CAB-LMR400-60	2867380	523			
PSR-SCF-24DC/ESD/4X1/30	2981800	44	PSR-SPP-24UC/URM/5X1/2X2	2963970	63	RAD-CAB-LMR400-80	2867393	523			
PSR-SCF-24DC/ESD/5X1/1X2/T 1	2981143	45	PSR-SPP-24UC/URM/4X1/2X2	2964005	48	RAD-CAB-LMR500-25	5606126	523	S-PT-EX-24DC	2800034	431
PSR-SCF-24DC/ESD/5X1/1X2/T 3	2981224	45	PSR-SPP-24UC/URM/4X1/2X2/B	2981046	49	RAD-CAB-LMR600-150	2885184	523	SAC-2P-2,0-910/FSB SCO	1518067	254
PSR-SCF-24DC/ESD/5X1/1X2/T 5	2981266	45	PSR-SPP-60UC/ESAM4/3X1/1X2/B	2901427	42	RAD-CAB-LMR900-200	2885197	523	SAC-2P-5,0-910/FSB SCO	1518070	254
PSR-SCF-24DC/ESD/5X1/1X2/T 10	2981088	45	PSR-SPP-120UC/ESAM4/3X1/1X2/B	2901425	42	RAD-CAB-RG213-40	2867377	523	SAC-2P-10,0-910/FSB SCO	1518083	254
PSR-SCF-24DC/ESD/5X1/1X2/T 30	2981347	45	PSR-SPP-120UC/URM/5X1/2X2	2981415	63	RAD-CAB-RG213-50	2867225	523	SAC-2P-15,0-910/FSB SCO	1518096	254
PSR-SCF-24DC/ESD/5X1/1X2/OT 5	2981101	45	PSR-SPP-230AC/ESAM2/3X1/1X2/B	2901431	40	RAD-CABLE-USX	2903447	416	SAC-2P-M12MS ASI TR	1539570	55
PSR-SCF-24DC/ESD/5X1/1X2/300	2981428	44	PSR-SPP-230UC/ESAM4/3X1/1X2/B	2901429	42	RAD-CON-MCX-MCX-SS	2867607	522	SAC-2P-MSB/FSB SCO/910/...	1538092	408
PSR-SCF-24DC/ESP/4/2X1/1X2	2981020	74	PSR-SPP-24-230UC/ESAM4/3X1/1X2	2981127	43	RAD-CON-MCX-N-SB	2867717	522	SAC-2P-MSB/0,3-910/FSB SCO	1518106	254
PSR-SCF-24DC/FSP/1X1/1X2	2981978	72	PSR-SPP-24DC/MXF1/4X1/2X2/B	2902726	56	RAD-CON-MCX-RPSMA-EX	2885621	522	SAC-2P-MSB/0,5-910/FSB SCO	1518119	254
PSR-SCF-24DC/FSP/2X1/1X2	2986960	73	PSR-SPP-24DC/MXF2/4X1/2X2/B	2903255	56	RAD-CON-MCX90-N-SS	2885207	522	SAC-2P-MSB/1,0-910/FSB SCO	1518122	254
PSR-SCF-24DC/FSP/2X1/1X2	2986575	73	PSR-SPP-24DC/MXF3/4X1/2X2/B	2903258	56	RAD-CON-SMA-N-SS	2867403	522	SAC-2P-MSB/10,0-910 SCO	1518025	254
PSR-SCF-24DC/MXF1/4X1/2X2/B	2902725	56	PSR-SPP-24DC/MXF4/4X1/2X2/B	2903261	56	RAD-CONF-RF3	2902814	499	SAC-2P-MSB/2,0-910/FSB SCO	1518135	254
PSR-SCF-24DC/RSM4/4X1	2981538	62	PSR-SPP-24DC/URML4/3X1/1X2/B	2903584	49	RAD-CONF-RF5	2902815	499	SAC-2P-MSB/5,0-910 SCO	1518038	254
PSR-SCF-24DC/SDC4/2X1/B	2981486	51	PSR-SPP-42-230UC/URM4/4X1/2X2/B	2902936	49	RAD-CONF-RF7	2902816	499	SAC-2P-MSB/5,0-910/FSB SCO	1518148	254
PSR-SCF-24DC/SIM4	2981936	53	PSR-SPP-42-48UC/ESAM4/3X1/1X2/B	2901417	42	RAD-DAIO6-IFS	2901533	500	SAC-2P-MSB/10,0-910 SCO	1518041	254
PSR-SCF-24DC/TS/M	2986012	79	PSR-TBUS	2890425	54	RAD-DI4-IFS	2901535	500	SAC-2P-MSB/10,0-910/FSB SCO	1518151	254
PSR-SCF-24DC/TS/S	2986229	78	PSR-TBUS-TP	2981716	54	RAD-DI8-IFS	2901539	501	SAC-2P-MSB/15,0-910 SCO	1518054	254
PSR-SCF-24DC/TS/SDI8/SDIO4	2986038	80	PSR-TRISAFE STARTER KIT	2986300	78	RAD-DO8-IFS	2902811	501	SAC-2P-MSB/15,0-910/FSB SCO	1518164	254
PSR-SCF-24DC/TS/SDOR4/4X1	2986096	80	PT 2X2-FF-ST	2800755	431	RAD-DOR4-IFS	2901536	501	SAC-3P-M12Y/2XM12FS PE	1683455	253
PSR-SCF-24DC/URD3/4X1/2X2	2981512	52	PT 4+F-BE	2839415	431	RAD-IN+OUT-2D-1A-I	2867322	513	SAC-4P-2,0-186/FS SCO	1555648	255
PSR-SCF-24DC/URD3/4X1/2X2/3	2981732	51	PT 4-BE	2839402	431	RAD-IN-2D-CNT	2885223	513	SAC-4P-2,0-950/M 8FR	1550902	256
PSR-SCF-24DC/URD3/4X1/2X2/T 2	2981703	52				RAD-IN-4A-I	2867115	512	SAC-4P-2,0-950/M 8FS	1543294	256
PSR-SCF-24DC/URM4/4X1/2X2/B	2981677	51				RAD-IN-8D	2867144	512	SAC-4P-2,0-PUR/M 8FR 0,34	1553077	256
PSR-SCF-24DC/ESA2/4X1/1X2/B	2963802	40				RAD-ISM-2400-ANT-OMNI-2-1	2867461	514	SAC-4P-2,0-PUR/M 8FS 0,34	1543582	256
PSR-SCF-24UC/ESAM4/2X1/1X2	2900525	41				RAD-ISM-2400-ANT-OMNI-2-1-RSMA	2701362	514	SAC-4P-5,0-186/FS SCO	1555651	255
PSR-SCF-24UC/ESAM4/3X1/1X2/B	2900509	42				RAD-ISM-2400-ANT-OMNI-6-0	2885919	515	SAC-4P-5,0-950/M 8FR	1550915	256
PSR-SCF-24UC/ESAM4/8X1/1X2	2963912	43				RAD-ISM-2400-ANT-PAN- 8-0	2867610	515	SAC-4P-5,0-950/M 8FS	1543304	256
PSR-SCF-24UC/ESL4/3X1/1X2/B	2981059	46				RAD-ISM-2400-ANT-PAR-19-0	2867885	516	SAC-4P-5,0-PUR/M 8FR 0,34	1553080	256
PSR-SCF-24UC/THC4/2X1/1X2	2963721	47				RAD-ISM-2400-ANT-VAN- 3-0-SMA	2885867	514	SAC-4P-5,0-PUR/M 8FS 0,34	1534818	256
PSR-SCF-24UC/URM/3X1/3X2	2981839	64	Q 1,5/4A50/24-M20KU-ESA-ASI BK	1437274	267	RAD-ISM-2400-ANT-VAN- 3-1-MCX	2885702	514	SAC-4P-10,0-PUR/M 8FS SCO	1543595	255
PSR-SCF-24UC/URM/5X1/1X2	2981952	64	Q 1,5/4FL/24-M20KU-ESA-ASI BK	1437261	267	RAD-ISM-2400-ANT-VAN-3-0-RSMA	2701358	514	SAC-4P-10,0-950/M 8FR	1550928	256
PSR-SCF-24UC/URM/5X1/2X2	2963747	63	Q 1,5/4IDC/24-24KU-KU-ASI-BK	1585058	267	RAD-ISM-2459-ANT-FOOD-6-0	2692526	514	SAC-4P-10,0-950/M 8FS	1543317	256
			QUICK WIREFOX 6	1204384	407						
PSR-SCF-24UC/URM4/5X1/2X2	2963734	48				RAD-ISM-5000-ANT-PAR-18-N	5606613	516	SAC-4P-10,0-PUR/M 8FR 0,34	1553093	256
PSR-SCF-24UC/URM4/5X1/2X2/B	2981033	49				RAD-ISM-5000-ANT-PAR-22-N	5606174	516	SAC-4P-10,0-PUR/M 8FS 0,34	1543595	256
PSR-SCF-60UC/ESAM4/3X1/1X2/B	2901426	42				RAD-ISM-900-ANT-OMNI-0-6	2867160	521	SAC-4P-15,0-186/FS SCO	1555677	255
PSR-SCF-120UC/ESAM4/3X1/1X2/B	2901422	42				RAD-ISM-900-ANT-OMNI-5	2867199	521	SAC-4P-20,0-950/M 8FR	1550944	256
PSR-SCF-120UC/URM/5X1/2X2	2981402	63				RAD-ISM-900-ANT-OMNI-FG-3-N	2867791	521	SAC-4P-20,0-950/M 8FS	1543333	256
PSR-SCF-230AC/ESAM2/3X1/1X2/B	2901430	40				RAD-ISM-900-ANT-OMNI-PAR-22-N	2885579	521	SAC-4P-20,0-PUR/M 8FR 0,34	1553116	256
PSR-SCF-230UC/ESAM4/3X1/1X2/B	2901428	42				RAD-ISM-900-ANT-YAGI-10-N	5606614	516			

Index

Alphabetical

Type	Order No.	Page	Type	Order No.	Page	Type	Order No.	Page	Type	Order No.	Page
VS-ASI-FC-TPE-UL-YE 100M	1404922	267									
VS-ASI-J-Y-B-FFKDS	1404498	268									
VS-ASI-J-Y-B-M12FS	1404427	269									
VS-ASI-J-Y-B-PUR-1,0-M12FR SCO	1404469	268									
VS-ASI-J-Y-B-PUR-1,0-M12FS SCO	1404456	268									
VS-ASI-J-Y-B-PUR-2,0-M12FR SCO	1404485	268									
VS-ASI-J-Y-B-PUR-2,0-M12FS SCO	1404472	268									
VS-ASI-J-Y-N-M12FS	1404414	269									
VS-ASI-J-Y-N-M12FS-LC	1433155	269									
VS-ASI-J-Y-N-PUR-1,0-M12FS SCO	1404430	268									
VS-ASI-J-Y-N-PUR-2,0-M12FS SCO	1404443	268									
VS-ASI-J-Y-N-SWA-LC	1433168	269									
VS-ASI-J-Y-Y-N	1404508	268									
VS-SCRJ-GOF-BU/BU	1652978	379									
VS-SCRJ-POF-POLISH	1656673	379									

W

WEBVISIT 6 BASIC	2700948	441
WEBVISIT 6 BASIC-PRO	2700950	441
WEBVISIT 6 EXPRESS	2700954	441
WEBVISIT 6 PRO	2700949	441
WMS 9,5 (30X16)R	0800377	431
WP 04T	2913632	102
WP 06T	2913645	102
WP 06T/WT	2400163	103
WP 07T/WS	2700307	103
WP 07T/WT	2400164	103
WP 09T/WS	2700309	103
WP 10T	2700934	103
WP 15T	2700935	103
WP 3057V	2400251	100
WP 3070W	2400253	100
WP 3105S	2400254	101
WP 3120W	2400255	101
WP 3150S	2400285	101

Z

ZBF 12 CUS	0825018	253
ZBF 12:UNBEDRUCKT	0809735	253
ZBF 8 CUS	0825030	253
ZBF 8:UNBEDRUCKT	0808781	253
ZBN 18:UNBEDRUCKT	2809128	55
ZEC 1,0/ 6-LPV-3,5 C1	1915699	429
ZEC 1,5/ 4-LPV-5,0 C2,4 BK	1793260	429

For up-to-date modifications or supplements
to the catalog contents, please visit:
phoenixcontact.net/webcode/#0132

