

PART
NAME

TRANSPARENT BLUE NEMA ENCLOSURE

PART
No.

BT-2724

UL FILE #194432

MATERIAL:
POLYCARBONATE, TRANSPARENT BLUE
UL94V-2 FLAMMABILITY RATING
UV STABILIZED
SERVICE TEMPERATURE RANGE:
-40°C TO +120°C

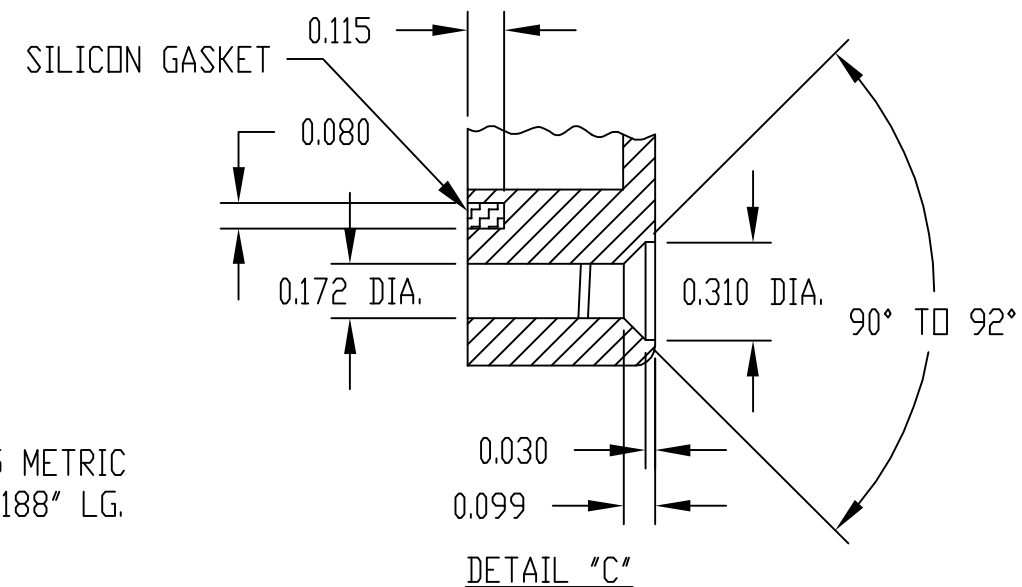

(* MOUNTING BOSSES USE EITHER M2.5 METRIC OR #4 STD. SHEET METAL SCREWS x 0.188" LG. (NOT SUPPLIED)

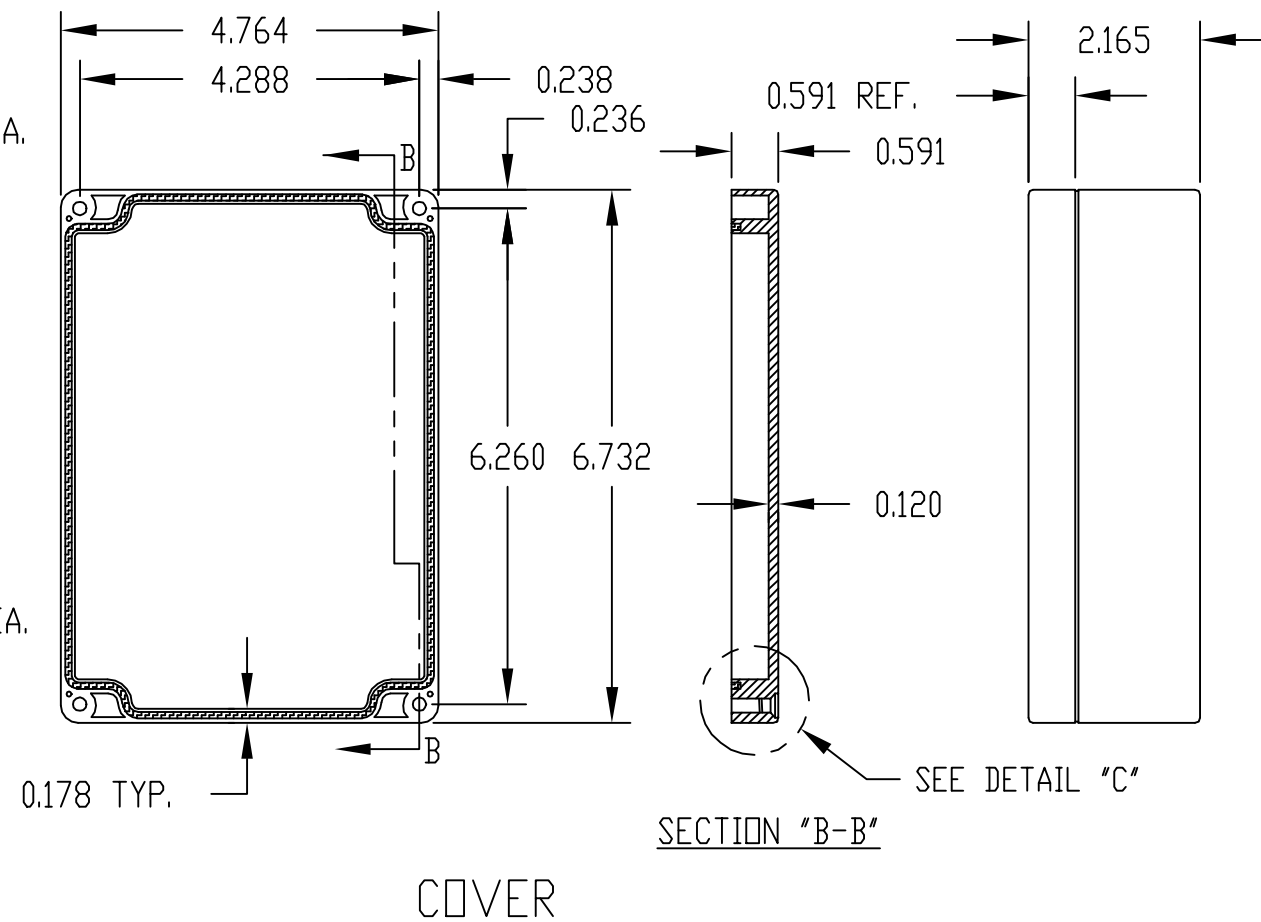
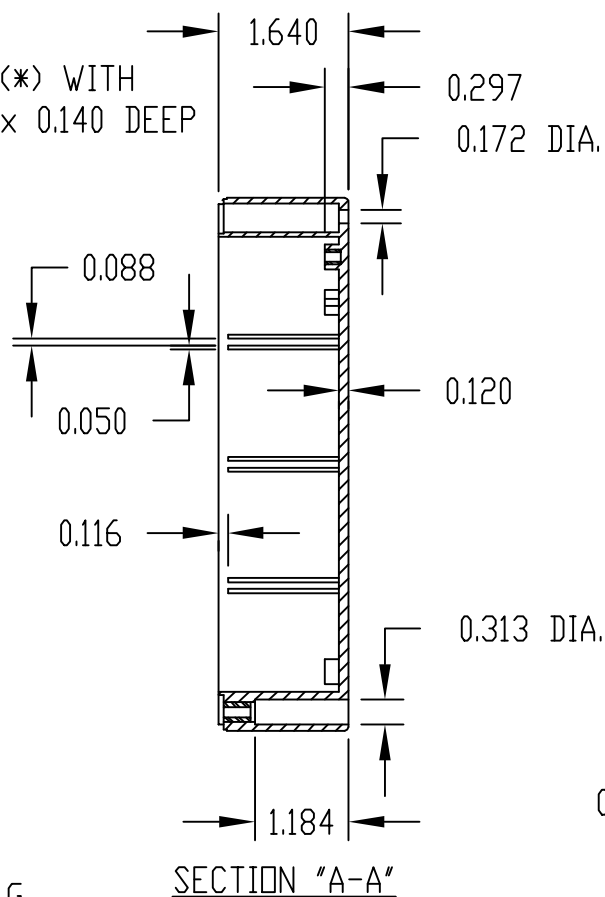
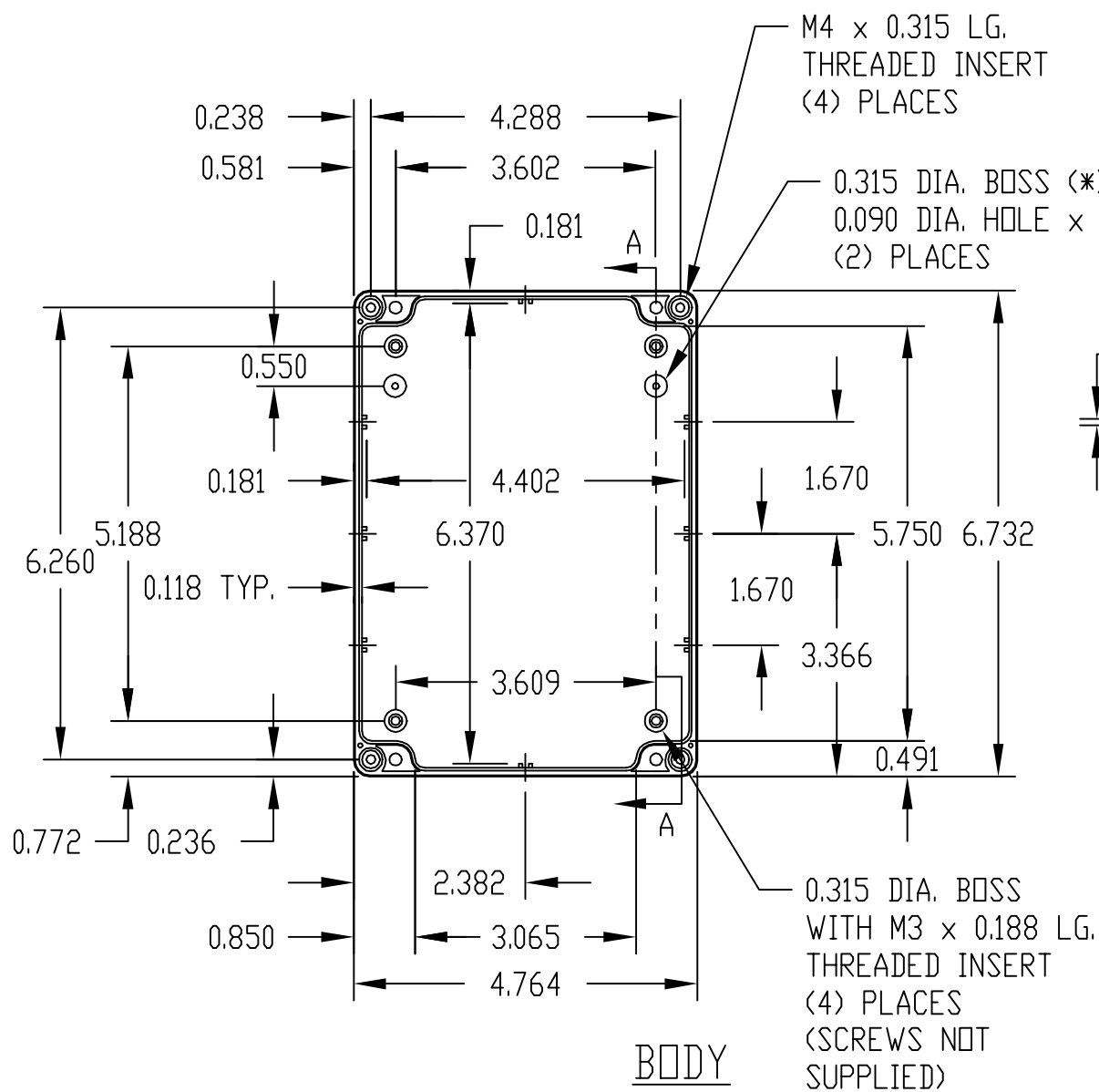

NOTE: ALL DIMENSIONS HAVE ±0.015 TOLERANCE UNLESS OTHERWISE SPECIFIED.

HARDWARE KIT
KIT CONTAINS (4) M4 x 20mm (0.787") LG. SCREWS FOR ASSEMBLY