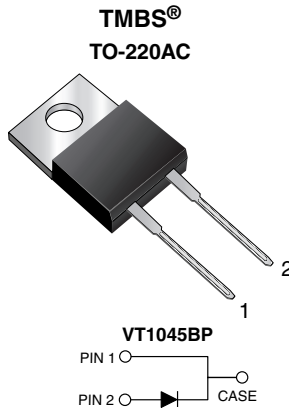

Trench MOS Barrier Schottky Rectifier for PV Solar Cell Bypass Protection

 Ultra Low $V_F = 0.41\text{ V}$ at $I_F = 5\text{ A}$

FEATURES

- Trench MOS Schottky technology
- Low forward voltage drop, low power losses
- High efficiency operation
- Solder dip 275 °C max. 10 s, per JESD 22-B106
- Material categorization: for definitions of compliance please see www.vishay.com/doc?99912

RoHS
COMPLIANT
HALOGEN
FREE

TYPICAL APPLICATIONS

For use in solar cell junction box as a bypass diode for protection, using DC forward current without reverse bias.

MECHANICAL DATA

Case: TO-220AC

 Molding compound meets UL 94 V-0 flammability rating
Base P/N-M3 - halogen-free, RoHS-compliant, and commercial grade

Terminals: Matte tin plated leads, solderable per J-STD-002 and JESD 22-B102

M3 suffix meets JESD 201 class 1A whisker test

Polarity: As marked

Mounting Torque: 10 in-lbs maximum

PRIMARY CHARACTERISTICS

| | |
|---------------------------------|------------|
| $I_{F(AV)}$ | 10 A |
| V_{RRM} | 45 V |
| I_{FSM} | 100 A |
| V_F at $I_F = 10\text{ A}$ | 0.52 V |
| T_{OP} max. (AC mode) | 150 °C |
| T_J max. (DC forward current) | 200 °C |
| Package | TO-220AC |
| Diode variation | Single die |

MAXIMUM RATINGS ($T_A = 25\text{ °C}$ unless otherwise noted)

| PARAMETER | SYMBOL | VT1045BP | UNIT |
|--|-------------------|-------------|------|
| Maximum repetitive peak reverse voltage | V_{RRM} | 45 | V |
| Maximum DC forward bypassing current (fig. 1) | $I_{F(DC)}^{(1)}$ | 10 | A |
| Peak forward surge current 8.3 ms single half sine-wave superimposed on rated load | I_{FSM} | 100 | A |
| Operating junction temperature range (AC mode) | T_{OP} | -40 to +150 | °C |
| Junction temperature in DC forward current without reverse bias, $t \leq 1\text{ h}$ | $T_J^{(2)}$ | ≤ 200 | °C |

Notes

⁽¹⁾ With heatsink

⁽²⁾ Meets the requirements of IEC 61215 ed.2 bypass diode thermal test



| ELECTRICAL CHARACTERISTICS (T _A = 25 °C unless otherwise noted) | | | | | | |
|--|-----------------------|-------------------------|-------------------------------|------|------|------|
| PARAMETER | TEST CONDITIONS | | SYMBOL | TYP. | MAX. | UNIT |
| Instantaneous forward voltage | I _F = 5 A | T _A = 25 °C | V _F ⁽¹⁾ | 0.50 | - | V |
| | I _F = 10 A | | | 0.57 | 0.68 | |
| | I _F = 5 A | T _A = 125 °C | | 0.41 | - | |
| | I _F = 10 A | | | 0.52 | 0.64 | |
| Reverse current | V _R = 45 V | T _A = 25 °C | I _R ⁽²⁾ | - | 500 | μA |
| | | T _A = 125 °C | | 5 | 15 | mA |

Notes

- (1) Pulse test: 300 μs pulse width, 1 % duty cycle
- (2) Pulse test: Pulse width ≤ 40 ms

| THERMAL CHARACTERISTICS (T _A = 25 °C unless otherwise noted) | | | |
|---|------------------|----------|------|
| PARAMETER | SYMBOL | VT1045BP | UNIT |
| Typical thermal resistance | R _{θJC} | 3.0 | °C/W |

| ORDERING INFORMATION (Example) | | | | | |
|--------------------------------|----------------|-----------------|--------------|---------------|---------------|
| PACKAGE | PREFERRED P/N | UNIT WEIGHT (g) | PACKAGE CODE | BASE QUANTITY | DELIVERY MODE |
| TO-220AC | VT1045BP-M3/4W | 1.87 | 4W | 50/tube | Tube |

RATINGS AND CHARACTERISTICS CURVES (T_A = 25 °C unless otherwise noted)

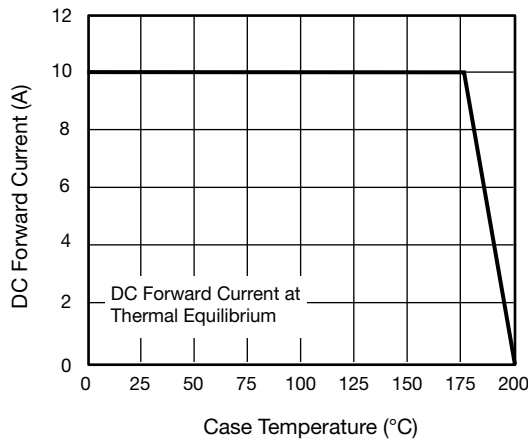

Fig. 1 - Maximum Forward Current Derating Curve

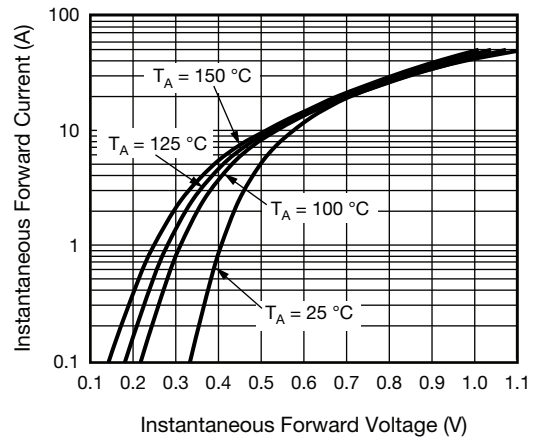
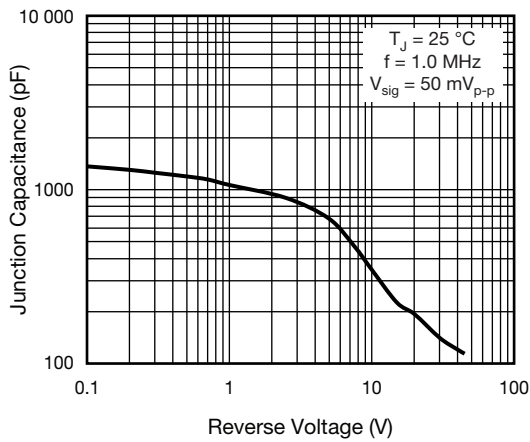
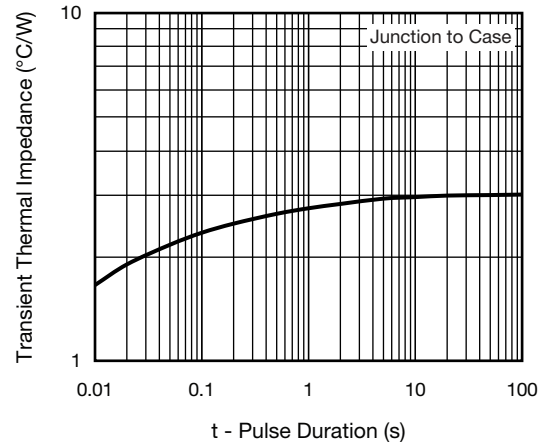
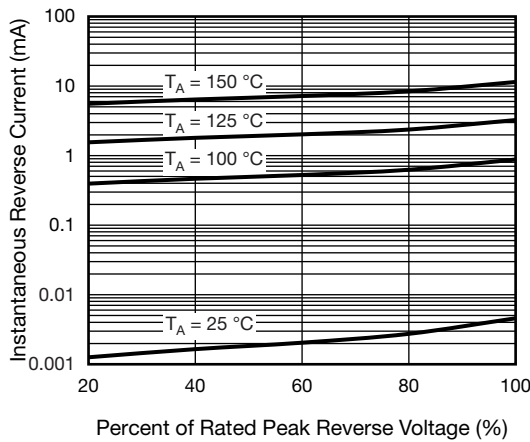
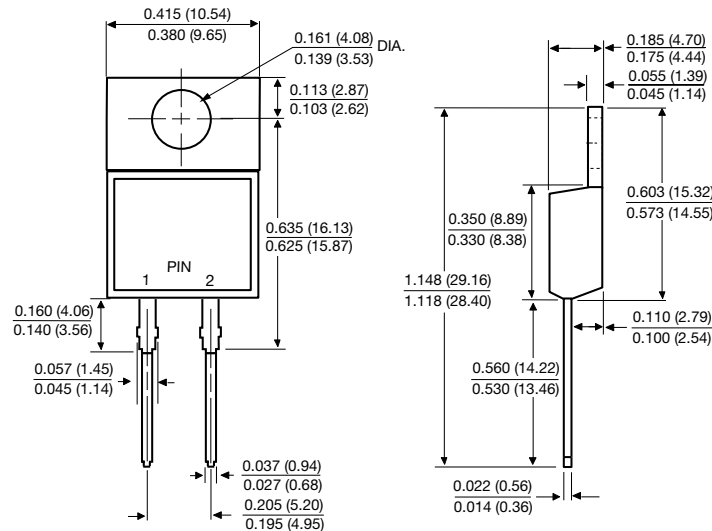

Fig. 2 - Typical Instantaneous Forward Characteristics



PACKAGE OUTLINE DIMENSIONS in inches (millimeters)

TO-220AC





Disclaimer

ALL PRODUCT, PRODUCT SPECIFICATIONS AND DATA ARE SUBJECT TO CHANGE WITHOUT NOTICE TO IMPROVE RELIABILITY, FUNCTION OR DESIGN OR OTHERWISE.

Vishay Intertechnology, Inc., its affiliates, agents, and employees, and all persons acting on its or their behalf (collectively, "Vishay"), disclaim any and all liability for any errors, inaccuracies or incompleteness contained in any datasheet or in any other disclosure relating to any product.

Vishay makes no warranty, representation or guarantee regarding the suitability of the products for any particular purpose or the continuing production of any product. To the maximum extent permitted by applicable law, Vishay disclaims (i) any and all liability arising out of the application or use of any product, (ii) any and all liability, including without limitation special, consequential or incidental damages, and (iii) any and all implied warranties, including warranties of fitness for particular purpose, non-infringement and merchantability.

Statements regarding the suitability of products for certain types of applications are based on Vishay's knowledge of typical requirements that are often placed on Vishay products in generic applications. Such statements are not binding statements about the suitability of products for a particular application. It is the customer's responsibility to validate that a particular product with the properties described in the product specification is suitable for use in a particular application. Parameters provided in datasheets and / or specifications may vary in different applications and performance may vary over time. All operating parameters, including typical parameters, must be validated for each customer application by the customer's technical experts. Product specifications do not expand or otherwise modify Vishay's terms and conditions of purchase, including but not limited to the warranty expressed therein.

Except as expressly indicated in writing, Vishay products are not designed for use in medical, life-saving, or life-sustaining applications or for any other application in which the failure of the Vishay product could result in personal injury or death. Customers using or selling Vishay products not expressly indicated for use in such applications do so at their own risk. Please contact authorized Vishay personnel to obtain written terms and conditions regarding products designed for such applications.

No license, express or implied, by estoppel or otherwise, to any intellectual property rights is granted by this document or by any conduct of Vishay. Product names and markings noted herein may be trademarks of their respective owners.